

The power behind competitiveness

Delta UPS - Modulon Family

DPH Series, Three Phase
200-500 kVA

User Manual

www.deltapowersolutions.com



DELTA
Smarter. Greener. Together.

Save This Manual

This manual contains important instructions and warnings that you should follow during the installation, operation, storage and maintenance of this product. Failure to heed these instructions and warnings will void the warranty.

Copyright © 2018 by Delta Electronics Inc. All Rights Reserved. All rights of this User Manual (“Manual”), including but not limited to the contents, information, and figures are solely owned and reserved by Delta Electronics Inc. (“Delta”). The Manual can only be applied to the operation or the use of this product. Any disposition, duplication, dissemination, reproduction, modification, translation, extraction, or usage of this Manual in whole or in part is prohibited without the prior written permission of Delta. Given that Delta will continuously improve and develop the product, changes may be made to the information in this Manual at any time without obligation to notify any person of such revision or changes. Delta will make all possible efforts to secure the accuracy and the integrity of this Manual. Delta disclaims any kinds or forms of warranty, guarantee, or undertaking, either expressly or implicitly, including but not limited to the completeness, faultlessness, accuracy, non-infringement, merchantability or fitness for a particular purpose of the Manual.

Table of Contents

1.	Important Safety Instructions	1-1
1.1	Installation Warnings	1-2
1.2	Connection Warnings	1-2
1.3	Usage Warnings	1-4
1.4	Storage Warnings	1-6
1.5	Standard Compliance	1-6
2.	Introduction	2-1
2.1	General Overview	2-2
2.2	Package Inspection	2-2
2.3	Functions & Features	2-4
2.4	Exterior and Dimensions	2-6
2.5	Front View	2-6
2.6	Internal View	2-8
2.7	Rear View	2-9
2.8	Tri-color LED Indicator & Buzzers	2-11
3.	Operation Modes	3-1
3.1	Single Input	3-4
3.1.1	Online Mode_ Single Input_ Single Unit	3-4
3.1.2	Battery Mode_ Single Input_ Single Unit	3-5
3.1.3	Bypass Mode_ Single Input_ Single Unit	3-6
3.1.4	Manual Bypass Mode_ Single Input_ Single Unit	3-6
3.1.5	ECO Mode_ Single Input_ Single Unit	3-8
3.1.6	Frequency Conversion Mode_ Single Input_ Single Unit	3-8
3.1.7	Green Mode_ Single Input_ Single Unit	3-9
3.1.8	Energy Recycle Mode_ Single Input_ Single Unit	3-10
3.1.9	Online Mode_ Single Input_ Parallel Units	3-11
3.1.10	Battery Mode_ Single Input_ Parallel Units	3-12
3.1.11	Bypass Mode_ Single Input_ Parallel Units	3-13
3.1.12	Manual Bypass Mode_ Single Input_ Parallel Units	3-14
3.1.13	ECO Mode_ Single Input_ Parallel Units	3-16
3.1.14	Frequency Conversion Mode_ Single Input_ Parallel Units	3-17
3.1.15	Green Mode_ Single Input_ Parallel Units	3-18
3.2	Dual Input	3-19
3.2.1	Online Mode_ Dual Input_ Single Unit	3-19
3.2.2	Battery Mode_ Dual Input_ Single Unit	3-19

3.2.3	Bypass Mode_ Dual Input_ Single Unit -----	3-20
3.2.4	Manual Bypass Mode_ Dual Input_ Single Unit-----	3-21
3.2.5	ECO Mode_ Dual Input_ Single Unit -----	3-22
3.2.6	Frequency Conversion Mode_ Dual Input_ Single Unit -----	3-23
3.2.7	Green Mode _ Dual Input_ Single Unit -----	3-24
3.2.8	Online Mode_ Dual Input_ Parallel Units -----	3-25
3.2.9	Battery Mode _ Dual Input_ Parallel Units -----	3-26
3.2.10	Bypass Mode_ Dual Input_ Parallel Units -----	3-27
3.2.11	Manual Bypass Mode_ Dual Input_ Parallel Units -----	3-28
3.2.12	ECO Mode_ Dual Input_ Parallel Units -----	3-30
3.2.13	Frequency Conversion Mode_ Single Input_ Parallel Units -----	3-31
3.2.14	Green Mode_ Dual Input_ Parallel Units -----	3-32
3.3	Hot Standby Redundancy (Only For Dual Input & At Least Two UPSs)----	3-33
3.4	Common Battery (Only for Parallel UPSs connecting to ----- the Same External Battery Cabinet(s))-----	3-34

4. Communication Interfaces ----- 4-1

4.1	Communication Interfaces on the Front of the UPS with Front Door Open	4-2
4.1.1	Display Port -----	4-3
4.1.2	REPO Dry Contacts -----	4-3
4.1.3	External Battery Temperature Dry Contacts -----	4-5
4.1.4	External Switch/ Breaker Status Dry Contacts -----	4-6
4.1.5	Output Dry Contacts-----	4-7
4.1.6	Input Dry Contacts-----	4-10
4.1.7	Parallel Communication Cards -----	4-11
4.1.8	Parallel Ports-----	4-11
4.1.9	SMART Slot -----	4-12
4.1.10	USB Port & RS-232 Port-----	4-12
4.1.11	Auxiliary Power Cards -----	4-12
4.1.12	Battery Start Buttons -----	4-13
4.2	Communication Interfaces at the Rear of the Touch Panel -----	4-13

5. Installation and Wiring----- 5-1

5.1	Before Installation and Wiring -----	5-2
5.2	Installation Environment -----	5-3
5.3	UPS Transportation -----	5-5
5.4	Fixing the UPS -----	5-6
5.5	Wiring-----	5-8
5.5.1	Pre-wiring Warnings-----	5-8

5.5.2	Single Input/ Dual Input Modification-----	5-10
5.5.3	Single Unit Wiring-----	5-12
5.5.4	Parallel Units Wiring -----	5-21
5.6	External Battery Cabinet Connection Warnings -----	5-25
5.7	STS Module-----	5-32
5.7.1	STS Module Installation -----	5-33
5.7.2	STS Module Removal -----	5-35
5.7.3	STS Module's LED Indicator -----	5-37
5.8	Power Module (Optional)-----	5-37
5.8.1	Power Module Installation -----	5-38
5.8.2	Power Module Removal -----	5-40
5.8.3	Power Module's LED Indicator -----	5-42
6.	UPS Operation-----	6-1
6.1	Pre Start-up & Pre Turn-off Warnings for Single Unit ----- and Parallel Units-----	6-2
6.2	Start-up Procedures -----	6-4
6.2.1	Online Mode Start-up Procedures -----	6-4
6.2.2	Battery Mode Start-up Procedures -----	6-8
6.2.3	Bypass Mode Start-up Procedures-----	6-10
6.2.4	Manual Bypass Mode Start-up Procedures -----	6-13
6.2.5	ECO Mode Start-up Procedures -----	6-18
6.2.6	Frequency Conversion Mode Start-up Procedures-----	6-22
6.2.7	Green Mode Start-up Procedures -----	6-26
6.2.8	Energy Recycle Mode Start-up Procedures-----	6-30
6.3	Turn-off Procedures-----	6-34
6.3.1	Online Mode Turn-off Procedures -----	6-34
6.3.2	Battery Mode Turn-off Procedures-----	6-36
6.3.3	Bypass Mode Turn-off Procedures -----	6-38
6.3.4	Manual Bypass Mode Turn-off Procedures-----	6-39
6.3.5	ECO Mode Turn-off Procedures-----	6-39
6.3.6	Frequency Conversion Mode Turn-off Procedures -----	6-42
6.3.7	Green Mode Turn-off Procedures-----	6-45
6.3.8	Energy Recycle Mode Turn-off Procedures -----	6-48
7.	LCD Display & Settings -----	7-1
7.1	LCD Display Hierarchy-----	7-2
7.2	Turning on the Touch Panel-----	7-3
7.3	ON/ OFF Button-----	7-5

7.4	Introduction of Touch Panel and Function Keys -----	7-7
7.5	Password Entry -----	7-11
7.6	Main Screen -----	7-12
7.7	Main Menu -----	7-16
7.8	Power Flow & Summary & System Status -----	7-17
7.9	Check System Readings -----	7-19
7.9.1	Main Input-----	7-19
7.9.2	Bypass Input -----	7-20
7.9.3	Inverter Output-----	7-20
7.9.4	Power Module Summary-----	7-21
7.9.5	UPS Output-----	7-21
7.9.6	Battery Status -----	7-22
7.10	UPS Settings -----	7-23
7.10.1	Bypass Setting-----	7-23
7.10.2	Mode Setting -----	7-24
7.10.3	Output Setting-----	7-25
7.10.4	Battery & Charging Setting -----	7-26
7.10.5	Parallel Setting-----	7-28
7.10.6	Dry Contact Setting -----	7-29
7.10.7	General Setting -----	7-31
7.10.8	IP Setting-----	7-33
7.10.9	Control -----	7-34
7.11	System Maintenance -----	7-35
7.11.1	Alarm Warning -----	7-35
7.11.2	Historical Event-----	7-36
7.11.3	Statistics-----	7-37
7.11.4	Test -----	7-38
7.11.5	Clear-----	7-38
7.11.6	Advanced Diagnosis -----	7-39
7.11.7	Version & S/N -----	7-40
8.	Optional Accessories -----	8-1
9.	Maintenance-----	9-1
10.	Troubleshooting -----	10-1
	Appendix 1: Technical Specifications-----	A1-1
	Appendix 2: Warranty-----	A2-1

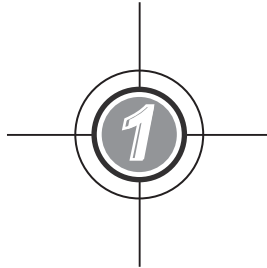

Important Safety Instructions

- 1.1 Installation Warnings
- 1.2 Connection Warnings
- 1.3 Usage Warnings
- 1.4 Storage Warnings
- 1.5 Standard Compliance

1.1 Installation Warnings

- This is a three-phase four-wire on-line uninterruptible power supply (hereafter referred to as 'UPS'). It can be used for commercial and industrial applications.
- Install the UPS in a well-ventilated indoor area, away from excess moisture, heat, dust, flammable gas or explosives.
- Leave adequate space around all sides of the UPS for proper ventilation and maintenance. Please refer to **5.2 Installation Environment**.
- Only authorized Delta engineers or service personnel can perform installation and maintenance. If you want to install the UPS by yourself, please install it under the supervision of authorized Delta engineers or service personnel
- Follow the IEC 60364-4-42 standard to install the UPS.

1.2 Connection Warnings

- Before applying electrical power to the UPS, make sure the UPS is grounded to avoid a possible risk of current leakage.
- You can parallel at maximum eight UPS units.
- The UPS must be connected with an external battery cabinet (user-supplied, handled and configured by Delta service personnel). Please refer to **5.6 External Battery Cabinet Connection Warnings** for relevant information.
- The UPS must be connected with a Delta or non-Delta external maintenance bypass cabinet. The Delta external maintenance bypass cabinet is optional, and the non-Delta external maintenance bypass cabinet is user-supplied and should be handled and configured by Delta service personnel. For the Delta or non-Delta external maintenance bypass cabinet's information, please refer to the table below.

Delta External Maintenance Bypass Cabinet (Optional)	There are two models for selection. Please refer to the table below.		
	Delta External Maintenance Bypass Cabinet (Optional)		
	Model	3915101965-S	3915101964-S
	Switch Q'ty	3 Switches (Input Switch/ Manual Bypass Switch/ Output Switch)	4 Switches (Input Switch/ Bypass Switch/ Manual Bypass Switch/ Output Switch)
	Wiring Type	Top & Bottom Wiring	Top & Bottom Wiring
		NOTE: For more information about the Delta external maintenance bypass cabinet (optional), please refer to its user manual.	

<p style="text-align: center;">Non-Delta External Maintenance Bypass Cabinet</p> <p>(User-supplied, handled and configured by Delta service personnel)</p>	<p>For configurations of the non-Delta external maintenance bypass cabinet, please refer to the following.</p> <ol style="list-style-type: none"> a. Selection of three or four breakers (switches): <ol style="list-style-type: none"> (1) Three breakers (switches): An input breaker (switch), a manual bypass breaker (switch) and an output breaker (switch) should be installed. (2) Four breakers (switches): An input breaker (switch), a bypass breaker (switch), a manual bypass breaker (switch) and an output breaker (switch) should be installed. b. Each breaker (switch) mentioned above must be a 3-pole (R/ S/ T) device and meets the specifications defined in Table 5-3. c. It is suggested that each breaker (switch) should be configured with an auxiliary contactor. For relevant information, please refer to 4.1.4 External Switch/ Breaker Status Dry Contacts. d. Install the non-Delta external maintenance bypass cabinet next to the UPS or align it with the UPS for convenient operation.
---	--



NOTE: If there are switches but not breakers installed in the external maintenance bypass cabinet, please install (1) an additional protective device between the input power and the external maintenance bypass cabinet and (2) an additional protective device between the connected critical loads and the external maintenance bypass cabinet. The protective device could be a breaker or a fuse. For the protective device’s rating current, please refer to the table below.

200kVA	300kVA	400kVA	500kVA
400A	600A	800A	1000A

- In this user manual, the meaning of Q0, Q1, Q2, Q3, Q4 and Q5 represents the following.

Code	Meaning
Q0	UPS’s Bypass Switch
Q1	Delta or non-Delta External Maintenance Bypass Cabinet’s Input Breaker or Switch
Q2	Delta or non-Delta External Maintenance Bypass Cabinet’s Bypass Breaker or Switch
Q3	Delta or non-Delta External Maintenance Bypass Cabinet’s Manual Bypass Breaker or Switch
Q4	Delta or non-Delta External Maintenance Bypass Cabinet’s Output Breaker or Switch
Q5	External Battery Cabinet’s Breaker

- The installation of protective devices is highly recommended when the UPS is connected to power sources.
- The protective devices connecting to the UPS must be installed near the UPS and easily accessible for operation.
- Protective Devices:
 1. It is suggested that you install appropriate protective devices between the UPS and input AC power. The protective devices should have the functions of over current protection, short circuit protection, insulating protection and shunt trip feature. Please refer to the table below for different UPS's cut off current (I_{cc}).

200kVA	300kVA	400kVA	500kVA
10kA	10kA	12.12kA	15.15kA

2. For selection of the protective devices, please take each power cable's current capacity and the system's overload capacity (please refer to **Appendix 1: Technical Specifications**) into consideration. Besides, the short-circuit capacity of the upstream protective devices must be equal to or higher than the capacity of the UPS's protective devices.
 3. For single input, when the UPS has abnormalities and input short current reaches 20kA, the UPS's internal semi-conductor fast-acting fuses need 8ms ~ 10ms to be fused. Thus, the upstream protective devices' reaction time should be more than 10ms to let the UPS's internal protective devices block breakdown and let the UPS transfer to bypass mode.
 4. For dual input, please install the protective devices between the UPS and the main AC source as well as between the UPS and the bypass AC source.
- If the UPS is supplied by a power source whose neutral is grounded, the backfeed protective device installed as UPS input protection must be a 3-pole type. If the UPS is supplied by a power source whose neutral is not grounded, the backfeed protective device installed as UPS input protection must be a 4-pole type.
 - The recommended electrical rating of the backfeed protective device is as follows.

200kVA	300kVA	400kVA	500kVA
690V/ 400A	690V/ 600A	690V/ 800A	690V/ 1000A

1.3 Usage Warnings

- Before installation, wiring and working on the UPS's internal circuits, please completely cut off all power supplying to the UPS, including the input power and battery power.

- The UPS is specifically designed for information technology equipment and used to power computers, servers, and associated peripheral devices. If you want to connect any capacitive loads or non-linear loads (that have serious surge current) to the UPS, it needs to be de-rated according to on-site applications. For such special applications, please contact Delta service personnel for the accurate UPS sizing. The UPS is not suitable for connecting with any asymmetrical loads.
- The external slits and openings in the UPS are provided for ventilation. To ensure reliable operation of the UPS and to protect the UPS from overheating, these slits and openings must not be blocked or covered. Do not insert any object into the slits and openings that may hinder ventilation.
- Before applying electrical power to the UPS, you must allow the UPS to adjust to room temperature (20°C~25°C) for at least one hour to avoid moisture condensing inside the UPS.
- Do not put beverages on the UPS, external battery cabinet, Delta or non-Delta external maintenance bypass cabinet or any other accessory associated with the UPS.
- Do not open or remove the covers or panels of the UPS to avoid high voltage electric shock. Only authorized Delta engineers or service personnel can do so for installation or maintenance. If you want to open or remove the covers or panels, do it only under the supervision of authorized Delta engineers or service personnel.
- It is strictly forbidden to connect the UPS to any regenerative loads.
- The risk of dangerous high voltage is possible when batteries are still connected to the UPS even though the UPS is disconnected from the power sources. Before maintenance, turn off the external battery cabinet's circuit breaker to completely cut off the battery power from the UPS.
- Do not dispose of the battery or batteries in a fire. The batteries may explode.
- Do not open or damage the battery or batteries. The released electrolyte is harmful to the skin and eyes and may be toxic.
- The UPS is electronic equipment that runs 24 hours continuously. To ensure its normal lifetime, regular maintenance of the UPS and batteries is of vital importance and necessary.
- Some components like batteries, power capacitors, and fans will become worn-out due to long-term usage, and this will increase the risk of UPS failure. To replace and maintain the components, please contact Delta service personnel.
- A battery can present a risk of electric shock and high short-circuit current. The following precautions should be observed before replacement of batteries:
 1. Remove watches, rings, or other metal objects.
 2. Use tools with insulated handles.

3. Wear insulating gloves and boots.
 4. Do not lay tools or metal parts on the top of batteries.
 5. Disconnect the charging source prior to connecting or disconnecting the batteries' terminals.
- You must contact Delta customer service if either of the following events occur:
 1. Liquid is poured or splashed on the UPS.
 2. The UPS does not run normally after carefully following the instructions in this User Manual.

1.4 Storage Warnings

- Use the original packing material to pack the UPS to prevent any possible damage from rodents.
- If the UPS needs to be stored prior to installation, it should be placed in a dry indoor area. The allowable storage temperature is below 70°C and relative humidity is below 95%.

1.5 Standard Compliance

- EN 62040-1
- EN 61000-6-4
- EN 62040-2 Category C3
- EN 61000-4-2
- EN 61000-4-3
- EN 61000-4-4
- EN 61000-4-5
- EN 61000-4-6
- EN 61000-4-8
- EN 61000-2-2
- YD/ T 2165-2010
- YD 5083-2005
- YD/ T 5096-2016

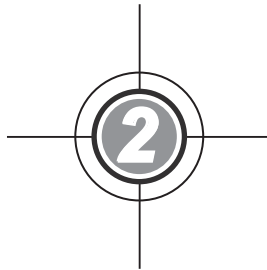

Introduction

- 2.1 General Overview
- 2.2 Package Inspection
- 2.3 Functions & Features
- 2.4 Exterior and Dimensions
- 2.5 Front View
- 2.6 Internal View
- 2.7 Rear View
- 2.8 Tri-color LED Indicator & Buzzers

2.1 General Overview

The DPH series UPS, a three-phase four-wire online uninterruptible power supply, is a dedicated design for data centers, factory facilities and large scale power systems. The unit not only adopts advanced IGBT technology to provide high quality, low noise, pure and uninterruptible output power to the connected loads, but also applies the latest design of DSP digital control technology and highest quality components.

The UPS supports high efficient operation modes and its modular and hot-swappable design makes maintenance easy and quick. You can add power modules (optional) according to on-site applications to expand overall system capacity, which realizes a highly cost-effective solution to your power requirements and produces greater electric power efficiency at less cost.

The unit provides diversified communication interfaces and has built-in SNMP and MODBUS cards for the user to facilitate remote control and management. You can parallel at maximum eight UPS units to increase the system capacity and redundancy and enhance the unit's availability and reliability.

2.2 Package Inspection

- External

During UPS transportation, some unpredictable situations might occur. It is recommended that you inspect the UPS exterior packaging. If you notice any damage, please immediately contact the dealer from whom you purchased the unit.

- Internal

1. Check the rating label attached to the UPS and make sure the device No. and capacity match what you ordered.
2. Examine if any parts are loose or damaged.
3. The UPS package contains the following items. Please check if any items are missing.

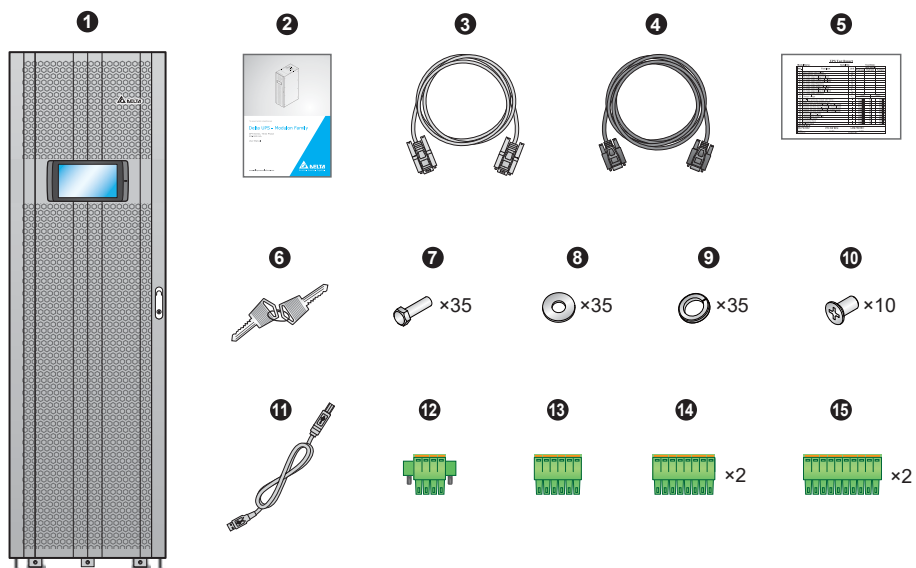

No.	Item	Q'ty
①	UPS (two pieces of 50ppi dust filters have been installed on the inner side of the UPS front door before shipment)	1 PC
②	User Manual	1 PC
③	RS-232 Cable (1.8 meters)	1 PC
④	Parallel Cable (3 meters)	1 PC
⑤	Test Report	1 PC
⑥	Key	1 PC (two copies placed inside the UPS cabinet)
⑦	M12 Screw (used for input/ output/ battery/ grounding wiring)	35 PCS
⑧	Washer (used for input/ output/ battery/ grounding wiring)	35 PCS
⑨	Washer Spring (used for input/ output/ battery/ grounding wiring)	35 PCS
⑩	M4 Screw (used to fix the parallel fasteners)	10 PCS
⑪	USB Cable	1 PC
⑫	4-Pin Dry Contact Terminal Block (used for REPO dry contacts; please refer to Figure 4-3)	1 PC
⑬	6-Pin Dry Contact Terminal Block (used for MODBUS and BMS ports located at the rear of the touch panel; please refer to Figure 4-15)	1 PC
⑭	8-Pin Dry Contact Terminal Block (used for (1) external battery temperature dry contacts and (2) external switch/ breaker status dry contacts; please refer to Figure 4-3)	2 PCS
⑮	10-Pin Dry Contact Terminal Block (used for input and output dry contacts; please refer to Figure 4-3)	2 PCS

4. If there is any damage or anything missing, please immediately contact the dealer from whom you purchased the unit.

5. If the UPS needs to be returned, carefully repack the UPS and all of the accessories using the original packing material that came with the unit.

2.3 Functions & Features

- Hot swappable STS module, communication interfaces and power modules (optional) realize on-line maintenance, reduce the MTTR (Mean Time to Repair) and expand system capacity flexibly (200 ~ 500kVA).
- Input power factor > 0.99 and input THDi < 3% save on installation cost and diminish power contamination.
- Output power factor= 1 (for 500kVA, output power factor is 0.9).
- Efficiency > 96% saves on operation cost.
- Automatic input frequency detection enables operation at 50Hz or 60Hz.
- Automatic restart:
 1. The UPS will restart in normal mode automatically right after the AC line resumes following a low battery shutdown.
 2. The UPS returns automatically to normal mode from bypass mode after an overload condition is cleared.
- Automatically detects whether bypass voltage is out of rating voltage (default: voltage $\pm 15\%$ & frequency $\pm 3\text{Hz}$). If yes, the UPS will stop supplying power to the critical loads to protect your electronic equipment.
- Supports ECO mode: when input voltage and frequency are within the range of rating voltage $\pm 10\%$ and rating frequency $\pm 3\text{Hz}$, the UPS will transfer to bypass mode; otherwise, the UPS will transfer to normal mode to reach higher efficiency.
- Both auxiliary power and control circuit adopt redundancy design, which doubly enhances UPS reliability.
- Suitable for top and bottom wiring by use of the Delta external maintenance bypass cabinet (optional).
- Generator compatible
- Surge protection and EMI filter functions.
- Remote emergency power off.
- Single input and dual input functions.
- Supports external switch/ breaker status detection.

- Wide AC input voltage range (140Vac~276Vac) reduces frequent transfer from normal mode to battery mode to save battery consumption and prolong battery life.
- AC start-up function even when the UPS is not connected to the batteries.

**WARNING:**

Please note that when the UPS is not connected to the batteries, it will not protect your equipment if the utility power is lost.

- Connects at maximum four external battery cabinets to extend backup time.
- Schedulable battery test and battery replacement alarm.
- Battery temperature monitoring and compensation.
- Battery monitoring system allows measurement of per battery cell's voltage and current.
- Smart battery charger design allows auto-charging or manual charging to shorten charging time.
- Provides communication interfaces and a smart slot (where you can install the optional Relay I/O card for dry contact expansion). Please refer to **4. Communication Interfaces**.
- Built-in RS-232 port and USB port located on the communication interfaces allow monitoring and management of the UPS. For relevant location and information, please refer to **Figure 4-3** and **Page 4-11**.
- Built-in SNMP card and MODBUS card located at the rear of the touch panel provide network communication and MODBUS communication respectively. For relevant location and information, please refer to **Page 4-12** and **Page 4-13**.
- Built-in SNMP card located at the rear of the touch panel allows remote monitoring, management and event log download of the UPS. For relevant location and information, please refer to **Page 4-12** and **Page 4-13**.
- Built-in USB ports () located at the rear of the touch panel allow upgrade of the UPS, touch panel, power modules, system control card and parallel communication cards' firmware and event log download. For relevant location and information, please refer to **Page 4-12** and **Page 4-13**.
- Built-in SRAM records at maximum 10000 event logs.
- 10-inch graphic and color touch panel enables the user to easily operate the UPS and understand the UPS status.
- Fan speed auto adjustment prolongs fan life and reduces noise when the critical loads decrease. Moreover, fan failure detection circuit is established.
- State-of-the-art microprocessor technology performs self-detection and monitors fan speed in real time, which provides complete and detailed operating status of the UPS.

2.4 Exterior and Dimensions

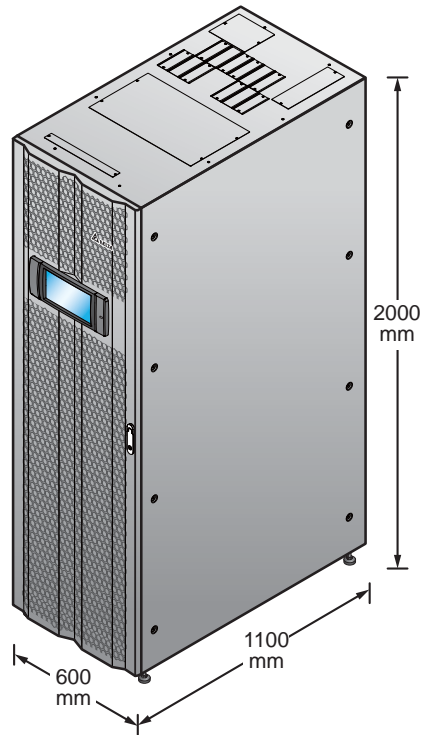

(Figure 2-1: Exterior & Dimensions)

2.5 Front View

On the front of the UPS, there are a 10" color touch panel, a tri-color LED indicator, a door switch, six casters and four leveling feet. Please see **Figure 2-2**.

1. For information about the 10" color touch panel, please refer to **7. LCD Display & Settings**.
2. For information about the tri-color LED indicator, please refer to **2.8 Tri-color LED Indicator & Buzzers**.
3. The casters at the bottom of the UPS can be used to move over short distances, and the leveling feet fix and stabilize the UPS on the ground. Please refer to **5.3 UPS Transportation** for relevant information.
4. Please refer to **Figure 2-3** for how to open the UPS front door.

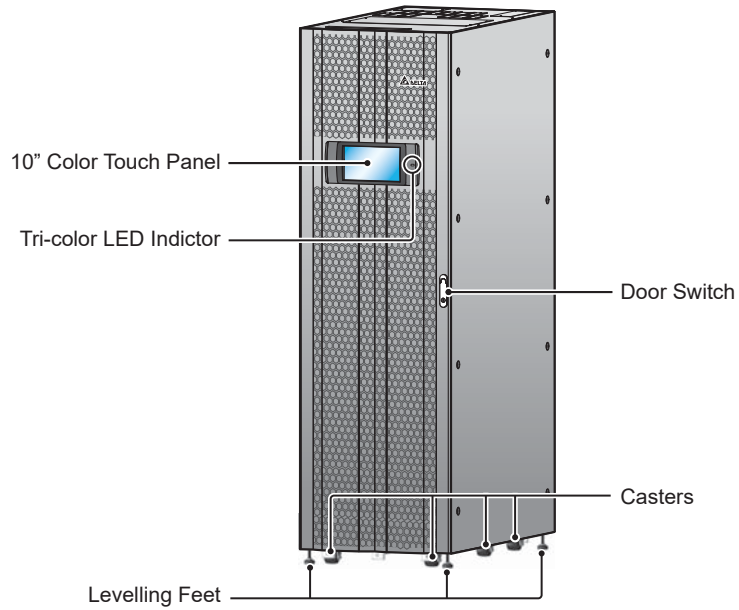

(Figure 2-2: UPS Front View)

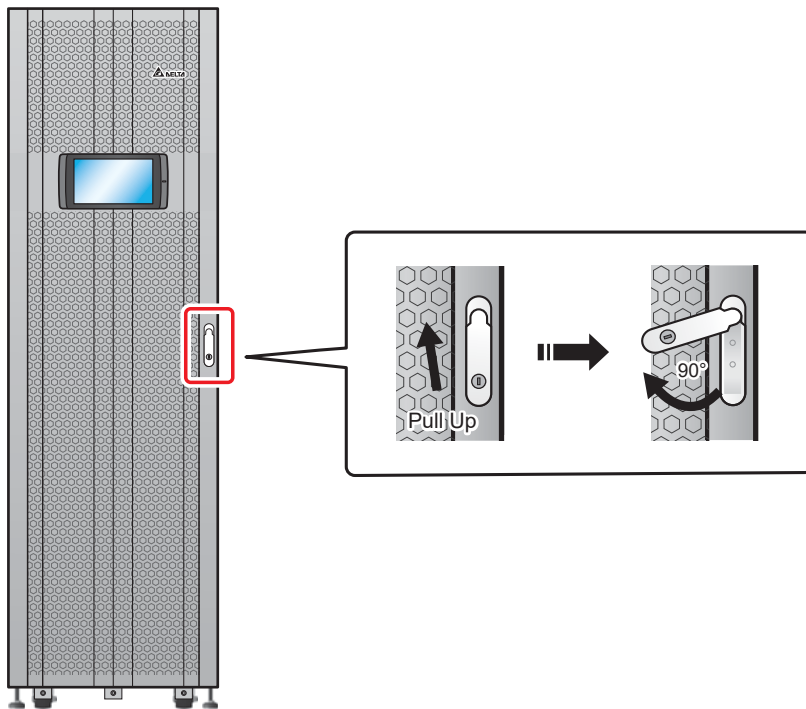

(Figure 2-3: How to Open the UPS Front Door)

2.6 Internal View



WARNING:

Only authorized Delta engineers or service personnel can perform installation, wiring, panel & cover removal, maintenance and operation. If you want to execute any action mentioned above by yourself, the action must be under the supervision of authorized Delta engineers or service personnel.

After you open the UPS's front door, you will see the internal mechanisms including communication interfaces, a bypass switch (Q0), an STS module, and nine power module slots. Please refer to **Figure 2-4**.

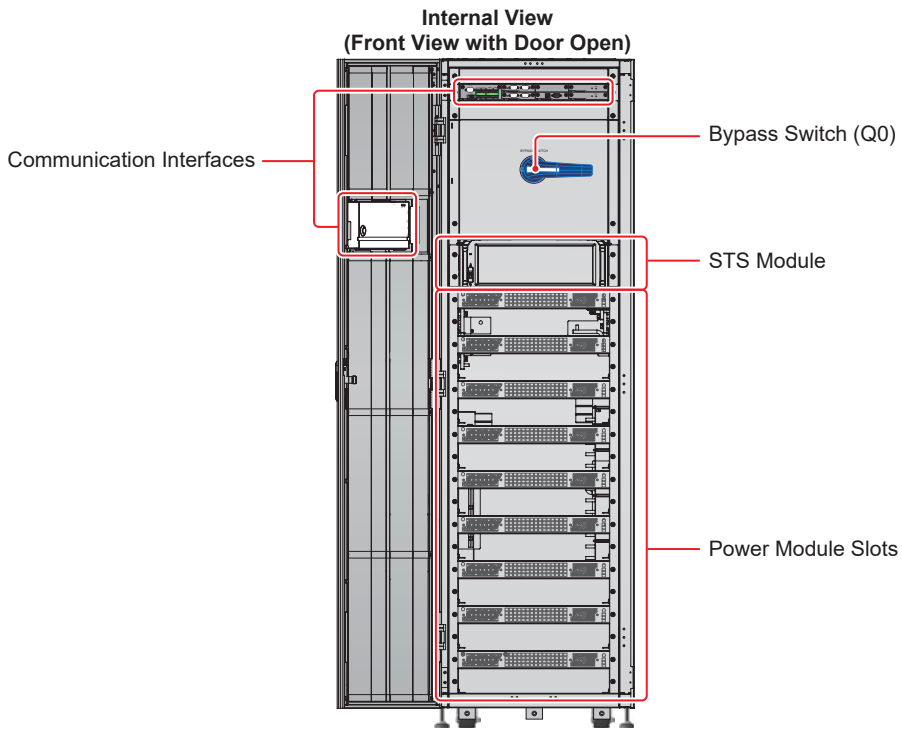

(Figure 2-4: UPS Internal View (Front View with Door Open))

1. For information about the communication interfaces, please refer to **4. Communication Interfaces**.
2. For how to turn on/ off the bypass switch (Q0), please refer to **Figure 2-5**.

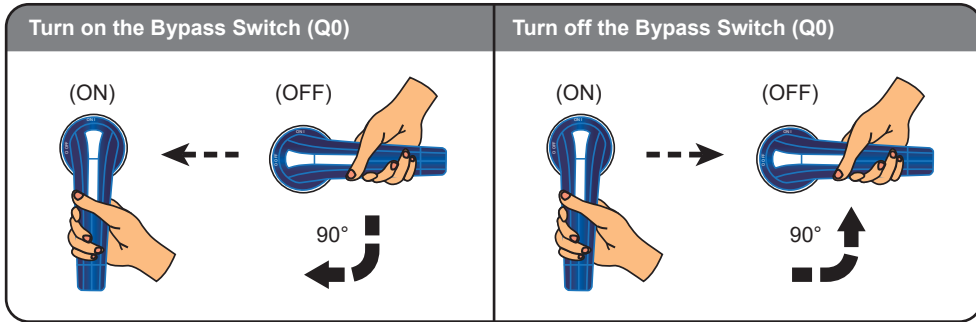

(Figure 2-5: Turn On/ Off the Bypass Switch (Q0))

3. For STS module information, please refer to **5.7 STS Module**.
4. For the power module slots, please follow on-site requirements to install appropriate number of power modules (optional) into the slots. Please refer to **5.8 Power Module (Optional)** for relevant information.

2.7 Rear View



WARNING:

Only authorized Delta engineers or service personnel can perform installation, wiring, panel & cover removal, maintenance and operation. If you want to execute any action mentioned above by yourself, the action must be under the supervision of authorized Delta engineers or service personnel.

The rear view of the UPS is shown in **Figure 2-6**. Please remove the rear panel (there are eight screws (see **Figure 2-7**) to see the wiring terminals shown in **Figure 2-8 ~ Figure 2-10**.

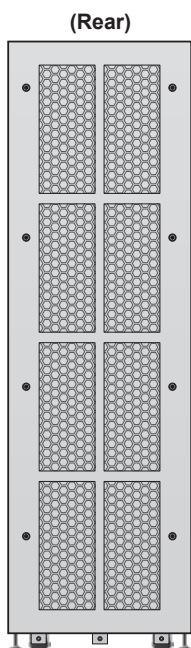

(Figure 2-6: UPS Rear View)

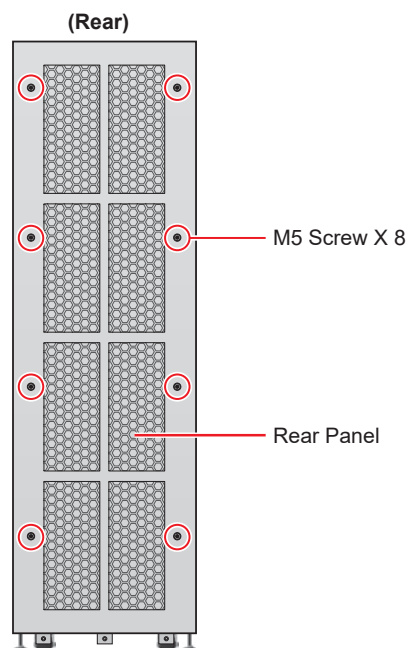

(Figure 2-7: UPS Rear Panel and Screw Location)

(Rear View after Rear Panel Removal)

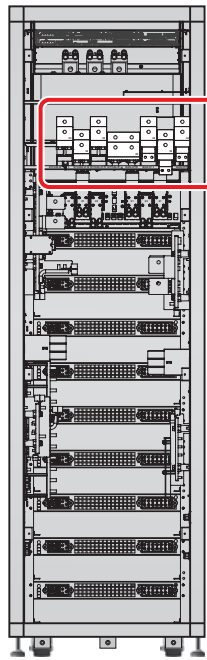

Bypass Input Terminals

AC Input Terminals

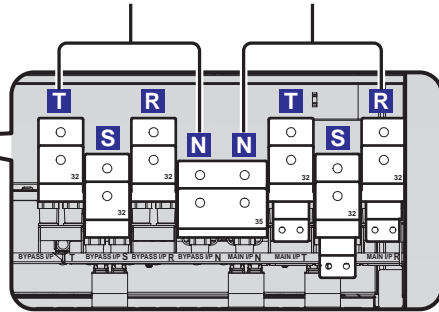

(Figure 2-8: Wiring Terminals_ AC Input & Bypass Input)

UPS Output Terminals

(Rear View after Rear Panel Removal)

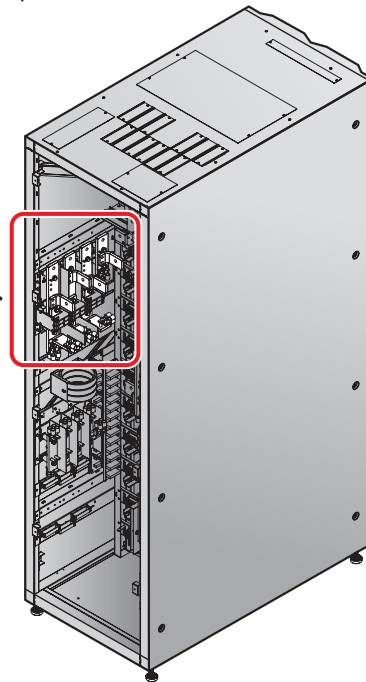
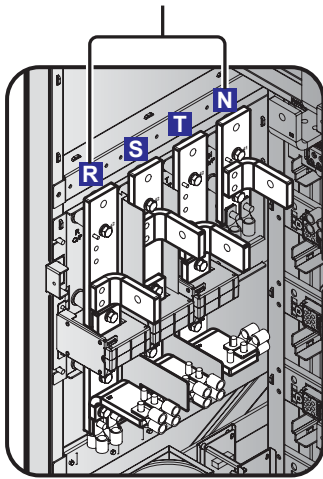

(Figure 2-9: Wiring Terminals_ UPS Output)

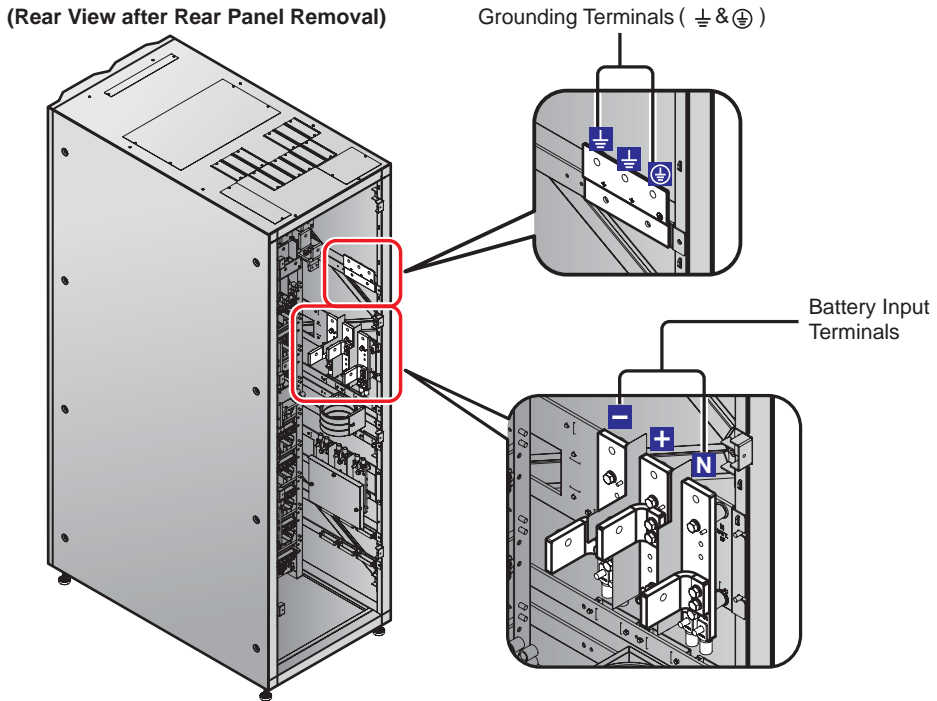

(Figure 2-10: Wiring Terminals_ Battery Input & Grounding)

2.8 Tri-color LED Indicator & Buzzers

Please see **Figure 2-11** for the location of the tri-color LED indicator. For information about the tri-color LED indicator, please refer to **Table 2-1**. For information about the 10" color touch panel, please refer to **7. LCD Display and Settings**.



(Figure 2-11: Tri-color LED Indicator Location)

Open the UPS front door and find the buzzers at the rear of the UPS front door. Please see **Figure 2-12**.

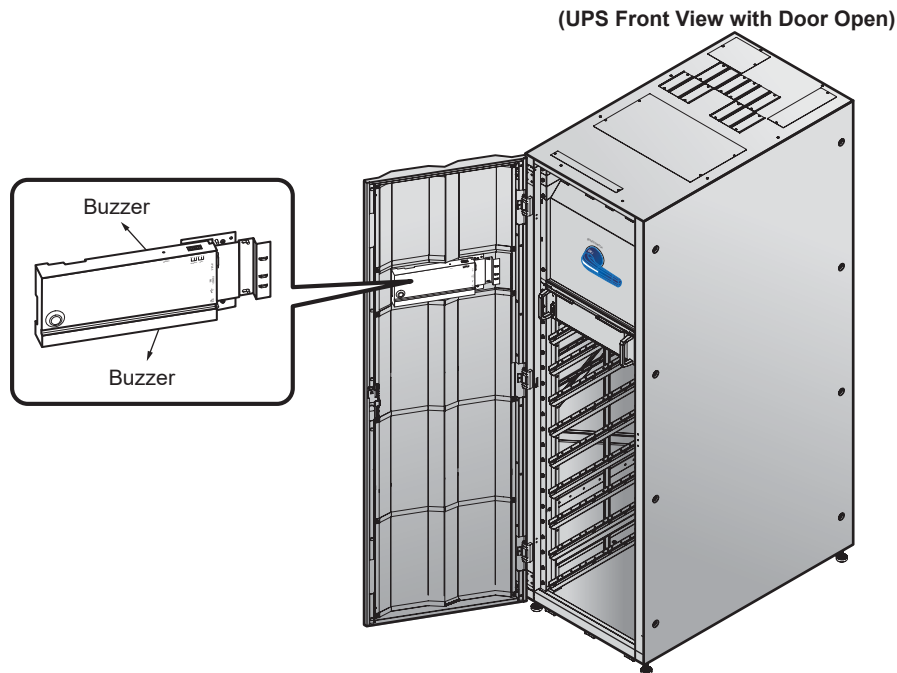

(Figure 2-12: Buzzers Location)

Please refer to the table below for the status of the tri-color LED indicator and buzzers.

Table 2-1: Tri-color LED Indicator & Buzzers

Tri-color LED Indicator	Status	Meaning
Green	ON	<ol style="list-style-type: none"> 1. The UPS is running in online mode and the text 'On-Line' appears in the upper right corner of the screen. 2. The UPS is running in ECO mode and the text 'ECO' appears in the upper right corner of the screen. 3. The UPS is running in frequency conversion mode and the text 'Frequency Conversion' appears in the upper right corner of the screen. 4. The UPS is running in green mode and the text 'Green' appears in the upper right corner of the screen.

Tri-color LED Indicator	Status	Meaning						
Yellow	ON	<ol style="list-style-type: none"> 1. The UPS is running in bypass mode and the text 'Bypass' appears in the upper right corner of the screen. 2. The UPS is running in battery mode and the text 'Battery' appears in the upper right corner of the screen. 3. The UPS is running in standby mode and the text 'Standby' appears in the upper right corner of the screen. 4. The UPS is in the soft start status and the text 'Softstart' appears in the upper right corner of the screen. 5. The UPS is in the energy recycle status and the text 'Energy Recycle' appears in the upper right corner of the screen. 6. There is a minor or medium warning and the buzzers sound. <table border="1" data-bbox="625 813 1236 1000"> <thead> <tr> <th data-bbox="625 813 828 852">Warning Level</th> <th data-bbox="828 813 1236 852">Buzzer Frequency</th> </tr> </thead> <tbody> <tr> <td data-bbox="625 852 828 925">Minor</td> <td data-bbox="828 852 1236 925">The buzzers beep 0.5 second for every three seconds.</td> </tr> <tr> <td data-bbox="625 925 828 1000">Medium</td> <td data-bbox="828 925 1236 1000">The buzzers beep 0.5 second for every second.</td> </tr> </tbody> </table> <p data-bbox="591 1025 1243 1051">To clear the warning, please refer to 10. Troubleshooting.</p>	Warning Level	Buzzer Frequency	Minor	The buzzers beep 0.5 second for every three seconds.	Medium	The buzzers beep 0.5 second for every second.
Warning Level	Buzzer Frequency							
Minor	The buzzers beep 0.5 second for every three seconds.							
Medium	The buzzers beep 0.5 second for every second.							
Red	ON	<p data-bbox="591 1074 1140 1099">There is a major warning and the buzzers sound.</p> <table border="1" data-bbox="625 1112 1236 1186"> <thead> <tr> <th data-bbox="625 1112 828 1151">Warning Level</th> <th data-bbox="828 1112 1236 1151">Buzzer Frequency</th> </tr> </thead> <tbody> <tr> <td data-bbox="625 1151 828 1186">Major</td> <td data-bbox="828 1151 1236 1186">Long beep</td> </tr> </tbody> </table> <p data-bbox="591 1211 1243 1236">To clear the warning, please refer to 10. Troubleshooting.</p>	Warning Level	Buzzer Frequency	Major	Long beep		
Warning Level	Buzzer Frequency							
Major	Long beep							

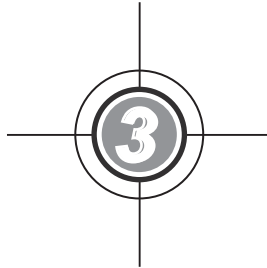

Operation Modes

3.1 Single Input

3.2 Dual Input

3.3 Hot Standby Redundancy
(Only For Dual Input & At
Least Two UPSs)

3.4 Common Battery (Only
For At Least Two Parallel
UPSs)

The UPS runs in eight basic operation modes, which are online mode, battery mode, bypass mode, manual bypass mode, ECO mode, frequency conversion mode, green mode and energy recycle mode. Besides these eight operation modes, the UPS is also designed for common battery application and hot standby redundancy. Please see the following sections for relevant information.



NOTE:

1. The UPS must be connected with a Delta or non-Delta external maintenance bypass cabinet. The Delta external maintenance bypass cabinet is optional, and the non-Delta external maintenance bypass cabinet is user-supplied and should be handled and configured by Delta service personnel. For the Delta or non-Delta external maintenance bypass cabinet's information, please refer to the table below.

<p>Delta External Maintenance Bypass Cabinet (Optional)</p>	<p>There are two models for selection. Please refer to the table below.</p> <table border="1" data-bbox="467 625 1210 929"> <thead> <tr> <th colspan="3" data-bbox="467 625 1210 678">Delta External Maintenance Bypass Cabinet (Optional)</th> </tr> <tr> <th data-bbox="467 678 635 730">Model</th> <th data-bbox="635 678 921 730">3915101965-S</th> <th data-bbox="921 678 1210 730">3915101964-S</th> </tr> </thead> <tbody> <tr> <th data-bbox="467 730 635 877">Switch Q'ty</th> <td data-bbox="635 730 921 877">3 Switches (Input Switch/ Manual Bypass Switch/ Output Switch)</td> <td data-bbox="921 730 1210 877">4 Switches (Input Switch/ Bypass Switch/ Manual Bypass Switch/ Output Switch)</td> </tr> <tr> <th data-bbox="467 877 635 929">Wiring Type</th> <td data-bbox="635 877 921 929">Top & Bottom Wiring</td> <td data-bbox="921 877 1210 929">Top & Bottom Wiring</td> </tr> </tbody> </table> <p> NOTE: For more information about the Delta external maintenance bypass cabinet (optional), please refer to its user manual.</p>	Delta External Maintenance Bypass Cabinet (Optional)			Model	3915101965-S	3915101964-S	Switch Q'ty	3 Switches (Input Switch/ Manual Bypass Switch/ Output Switch)	4 Switches (Input Switch/ Bypass Switch/ Manual Bypass Switch/ Output Switch)	Wiring Type	Top & Bottom Wiring	Top & Bottom Wiring
Delta External Maintenance Bypass Cabinet (Optional)													
Model	3915101965-S	3915101964-S											
Switch Q'ty	3 Switches (Input Switch/ Manual Bypass Switch/ Output Switch)	4 Switches (Input Switch/ Bypass Switch/ Manual Bypass Switch/ Output Switch)											
Wiring Type	Top & Bottom Wiring	Top & Bottom Wiring											
<p>Non-Delta External Maintenance Bypass Cabinet (User-supplied, handled and configured by Delta service personnel)</p>	<p>For configurations of the non-Delta external maintenance bypass cabinet, please refer to the following.</p> <ol style="list-style-type: none"> a. Selection of three or four breakers (switches): <ol style="list-style-type: none"> (1) Three breakers (switches): An input breaker (switch), a manual bypass breaker (switch) and an output breaker (switch) should be installed. (2) Four breakers (switches): An input breaker (switch), a bypass breaker (switch), a manual bypass breaker (switch) and an output breaker (switch) should be installed. c. Each breaker (switch) mentioned above must be a 3-pole (R/ S/ T) device and meets the specifications defined in Table 5-3. d. It is suggested that each breaker (switch) should be configured with an auxiliary contactor. For relevant information, please refer to 4.1.4 External Switch/ Breaker Status Dry Contacts. e. Install the non-Delta external maintenance bypass cabinet next to the UPS or align it with the UPS for convenient operation. 												



NOTE: If there are switches but not breakers installed in the external maintenance bypass cabinet, please install (1) an additional protective device between the input power and the external maintenance bypass cabinet and (2) an additional protective device between the connected critical loads and the external maintenance bypass cabinet. The protective device could be a breaker or a fuse. For the protective device's rating current, please refer to the table below.

200kVA	300kVA	400kVA	500kVA
400A	600A	800A	1000A

2. In this user manual, the meaning of Q0, Q1, Q2, Q3, Q4 and Q5 represents the following.

Code	Meaning
Q0	UPS's Bypass Switch
Q1	Delta or non-Delta External Maintenance Bypass Cabinet's Input Breaker or Switch
Q2	Delta or non-Delta External Maintenance Bypass Cabinet's Bypass Breaker or Switch
Q3	Delta or non-Delta External Maintenance Bypass Cabinet's Manual Bypass Breaker or Switch
Q4	Delta or non-Delta External Maintenance Bypass Cabinet's Output Breaker or Switch
Q5	External Battery Cabinet's Breaker

3. The structure of the UPS and the Delta or non-Delta external maintenance bypass cabinet is shown in **Figure 3-1** (single input application) and **Figure 3-2** (dual input application).

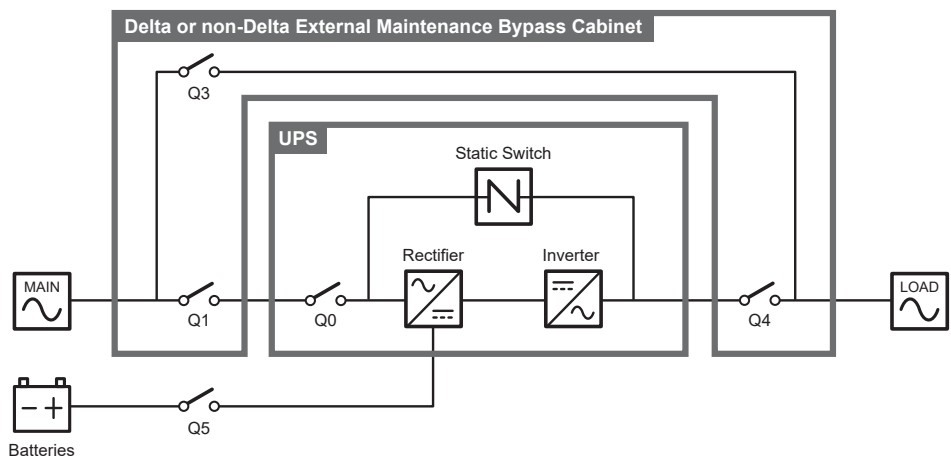

(Figure 3-1: Single Input Application_ UPS and Delta or non-Delta External Maintenance Bypass Cabinet Structure)

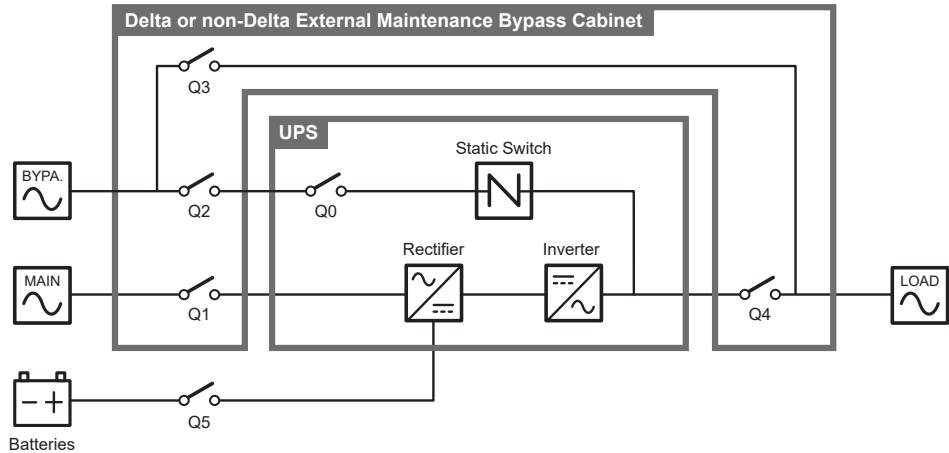

(Figure 3-2: Dual Input Application_ UPS and Delta or non-Delta External Maintenance Bypass Cabinet Structure)

- Up to eight UPS units can be paralleled for redundancy and capacity expansion. Only UPSs with the same capacity, voltage and frequency can be paralleled. Please only use the provided parallel cable to parallel the UPS units. Otherwise, parallel functions will fail.

3.1 Single Input

3.1.1 Online Mode_ Single Input_ Single Unit

In online mode, the main AC source supplies AC power via the Delta or non-Delta external maintenance bypass cabinet's Input Breaker or Switch (Q1) and the UPS's Bypass Switch (Q0) to the rectifier, and the rectifier converts the AC power to DC power and supplies the DC power to the inverter. In the meantime, the rectifier provides charging power to the batteries. After receiving the DC power, the inverter converts it into clean and stable AC power to the connected critical loads via the Delta or non-Delta external maintenance bypass cabinet's Output Breaker or Switch (Q4). Please refer to **Figure 3-3**. During online mode, the UPS's tri-color LED illuminates green and the text 'On-Line' appears in the upper right corner of the screen.

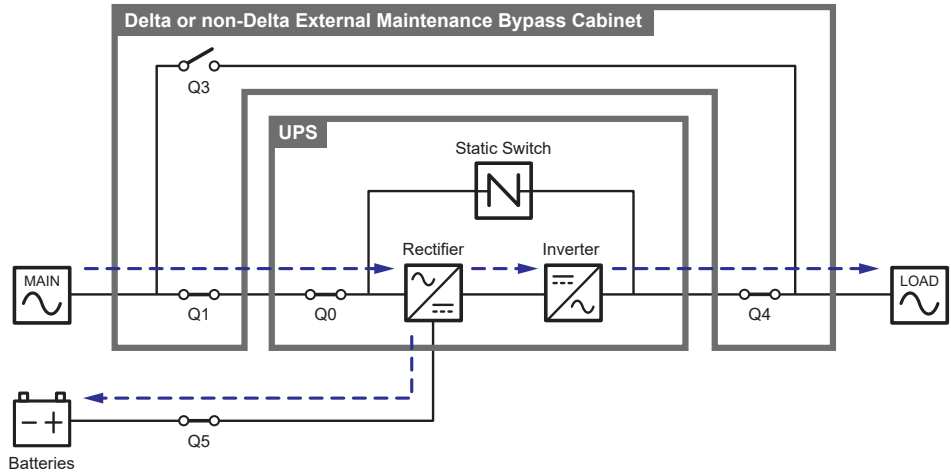

(Figure 3-3: Online Mode Diagram_ Single Input Single Unit)

3.1.2 Battery Mode_ Single Input_ Single Unit

The UPS transfers to battery mode automatically if the main AC source cannot supply power, for example, when unstable voltage or a power outage occurs. In battery mode, the batteries provide DC power and the UPS converts it into AC power and supplies it to the connected critical loads via the Delta or non-Delta external maintenance bypass cabinet's Output Breaker or Switch (Q4). During the conversion process, output voltage remains the same. Please see **Figure 3-4**. During battery mode, the UPS's tri-color LED illuminates yellow and the text 'Battery' appears in the upper right corner of the screen.

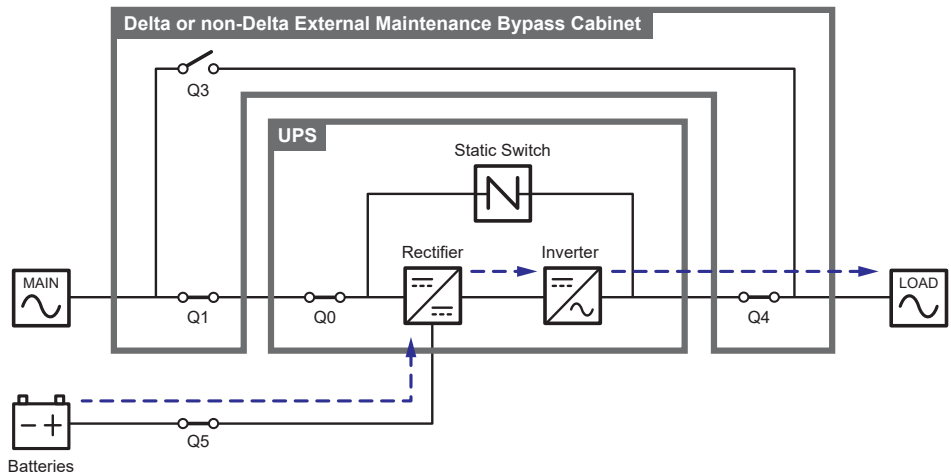

(Figure 3-4: Battery Mode Diagram_ Single Input Single Unit)

3.1.3 Bypass Mode_ Single Input_ Single Unit

When the inverter encounters abnormal situations such as over temperature, overload, short circuit, abnormal output voltage or low battery, it will automatically shut itself down. If the UPS detects the bypass AC source is normal, it will automatically switch to bypass mode to protect the connected critical loads from power interruption. Please refer to **Figure 3-5**. After the above-mentioned abnormalities are eliminated, the UPS will switch back to online mode from bypass mode. During bypass mode, the UPS's tri-color LED illuminates yellow and the text 'Bypass' appears in the upper right corner of the screen.

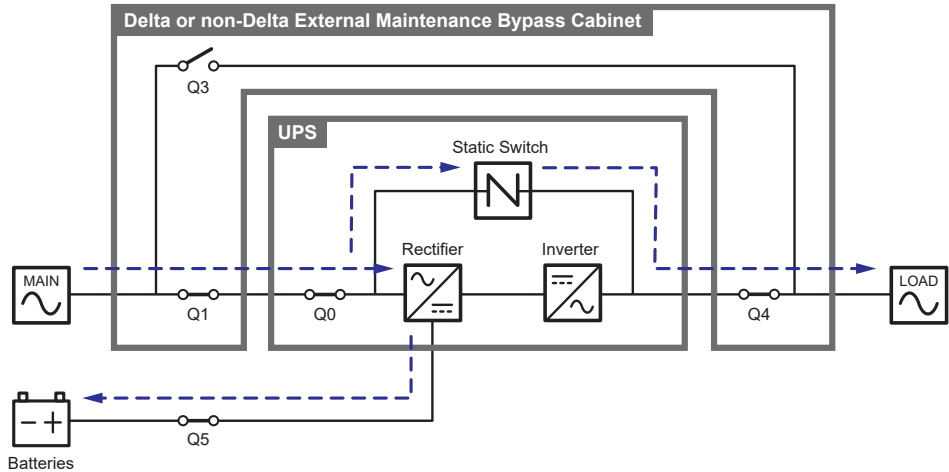

(Figure 3-5: Bypass Mode Diagram_ Single Input Single Unit)

3.1.4 Manual Bypass Mode_ Single Input_ Single Unit

When the UPS needs maintenance, you can manually switch the UPS to manual bypass mode. To let the UPS run in manual bypass mode, please follow the procedures below:

- 1 Confirm that the bypass AC source and the STS module are normal.
- 2 Press the LCD's ON/ OFF button () once and the 'POWER OFF?' screen will pop up to ask you if you want to power off the inverter. Please select 'YES'.
- 3 Turn on the Delta or non-Delta external maintenance bypass cabinet's Manual Bypass Breaker or Switch (Q3).
- 4 Turn off the UPS's Bypass Switch (Q0).
- 5 Turn off the Delta or non-Delta external maintenance bypass cabinet's Input Breaker or Switch (Q1) and Output Breaker or Switch (Q4).
- 6 Turn off each external battery cabinet's breaker (Q5).

In manual bypass mode, all power inside the UPS is completely cut off and maintenance personnel can perform maintenance safely. For manual bypass mode diagram, please see **Figure 3-6**. During manual bypass mode, the UPS's tri-color LED and LCD are both off.



WARNING:

1. In manual bypass mode, make sure that all of the breakers or switches (except the Delta or non-Delta external maintenance bypass cabinet's Manual Bypass Breaker or Switch (Q3)) are in the **OFF** position before working on the UPS's internal circuits. This avoids electric shock.
2. After the power inside the UPS is completely cut off, there is no high voltage in the UPS but in the Delta or non-Delta external maintenance bypass cabinet. Do not touch the Delta or non-Delta external maintenance bypass cabinet during UPS maintenance process to avoid electric shock.
3. During manual bypass mode, the UPS's input power is completely cut off and the connected critical loads are not protected.

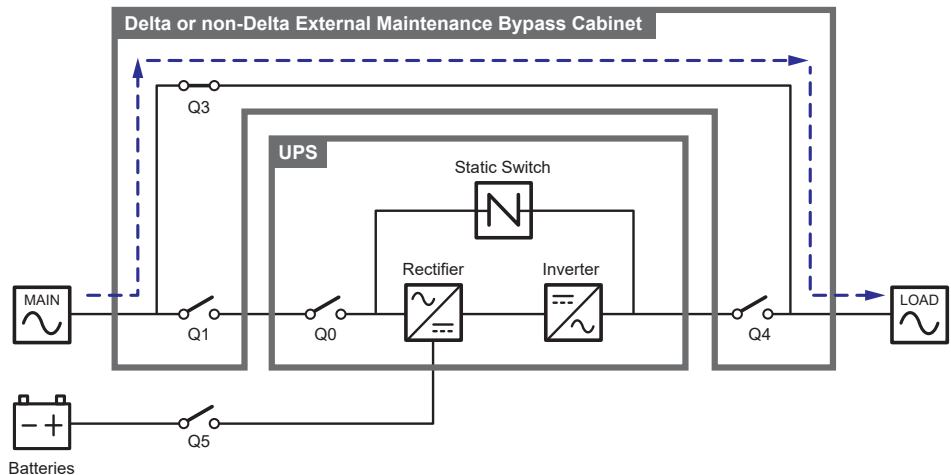

(Figure 3-6: Manual Bypass Mode Diagram_ Single Input Single Unit)

3.1.5 ECO Mode_ Single Input_ Single Unit

To activate ECO mode, please refer to **6.2.5 ECO Mode Start-up Procedures**, **7.6 Main Screen** and **7.10.2 Mode Setting**.

In ECO mode, when bypass AC source's input voltage and frequency are within the range of rating voltage $\pm 10\%$ and rating frequency $\pm 3\text{Hz}$, the UPS works in bypass mode; otherwise, the UPS runs in online mode. For ECO mode diagram, please see **Figure 3-7**. During ECO mode, the UPS's tri-color LED illuminates green and the text 'ECO' appears in the upper right corner of the screen.

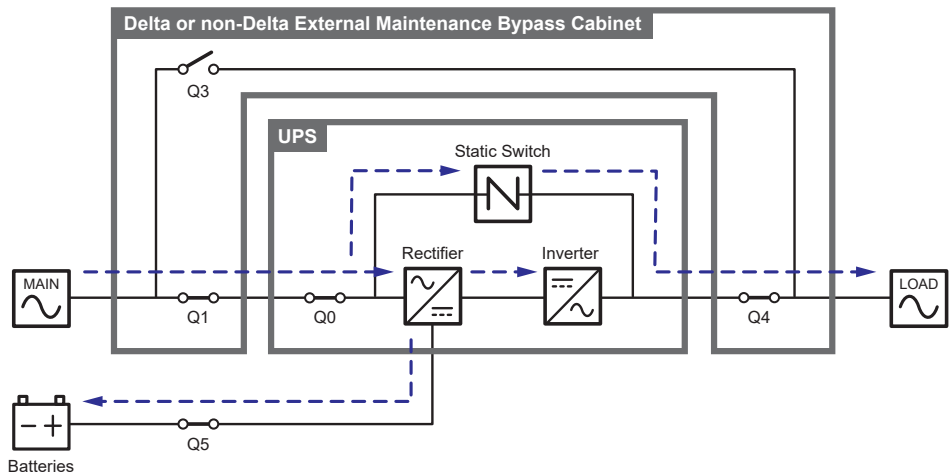

(Figure 3-7: ECO Mode Diagram_ Single Input Single Unit)

3.1.6 Frequency Conversion Mode_ Single Input_ Single Unit

To activate frequency conversion mode, please refer to **6.2.6 Frequency Conversion Mode Start-up Procedures**, **7.6 Main Screen** and **7.10.2 Mode Setting**.

After the UPS is manually set in frequency conversion mode, the inverter will automatically select 50Hz or 60Hz as the fixed output frequency. After the output frequency is determined, the system will automatically disable the bypass function. Please note that, once the inverter shuts down, there is no bypass output. For the diagram of frequency conversion mode, please see **Figure 3-8**. During frequency conversion mode, the UPS's tri-color LED illuminates green and the text 'Frequency Conversion' appears in the upper right corner of the screen.



NOTE: During frequency conversion mode, once the inverter shuts down, there is no bypass output.

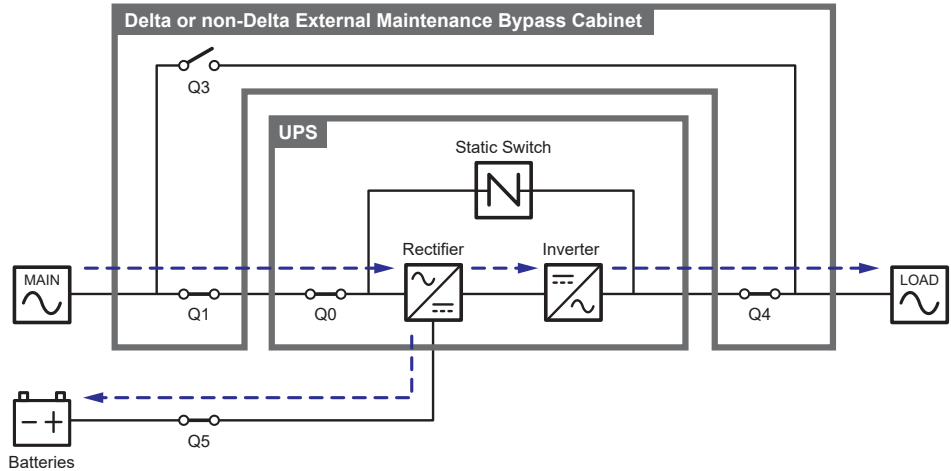

(Figure 3-8: Frequency Conversion Mode Diagram_ Single Input Single Unit)

3.1.7 Green Mode _ Single Input_ Single Unit

To activate green mode, please refer to **6.2.7 Green Mode Start-up Procedures**, **7.6 Main Screen** and **7.10.2 Mode Setting**.

Green mode is the same as online mode, but the difference is that the system will automatically detect the output status (i.e. total load capacity %) to decide which specific power modules should be fully powered on or idle in order to achieve higher efficiency of the UPS. For the green mode diagram, please see **Figure 3-9**. During green mode, the UPS's tri-color LED illuminates green and the text 'Green' appears in the upper right corner of the screen.

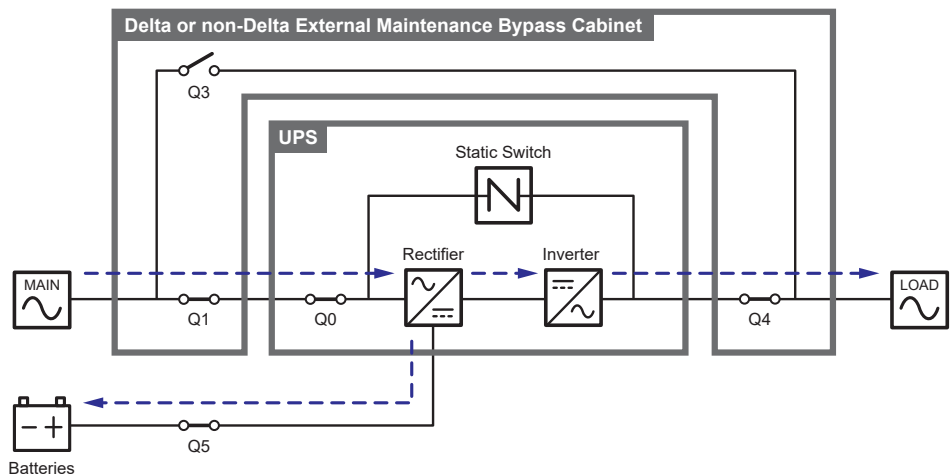

(Figure 3-9: Green Mode Diagram_ Single Input Single Unit)

3.1.8 Energy Recycle Mode _ Single Input_ Single Unit



NOTE: Energy recycle mode is only applicable to single input and single unit application.

Energy recycle mode is only applicable to UPS self-test only. Without connection of any critical loads, the UPS can execute current test under full load condition. Before you activate energy recycle mode, please make sure that the Delta or non-Delta external maintenance bypass cabinet's Manual Bypass Breaker or Switch (Q3), Output Breaker or Switch (Q4) and each external battery cabinet's battery breaker (Q5) are in the **OFF** status.

To activate energy recycle mode (only qualified service personnel can do so), please refer to **6.2.8 Energy Recycle Mode Start-up Procedures**, **7.6 Main Screen** and **7.10.2 Mode Setting**.

For the diagram of energy recycle mode, please see **Figure 3-10**. During energy recycle mode, the UPS's tri-color LED illuminates yellow and the text 'Energy Recycle' appears in the upper right corner of the screen.

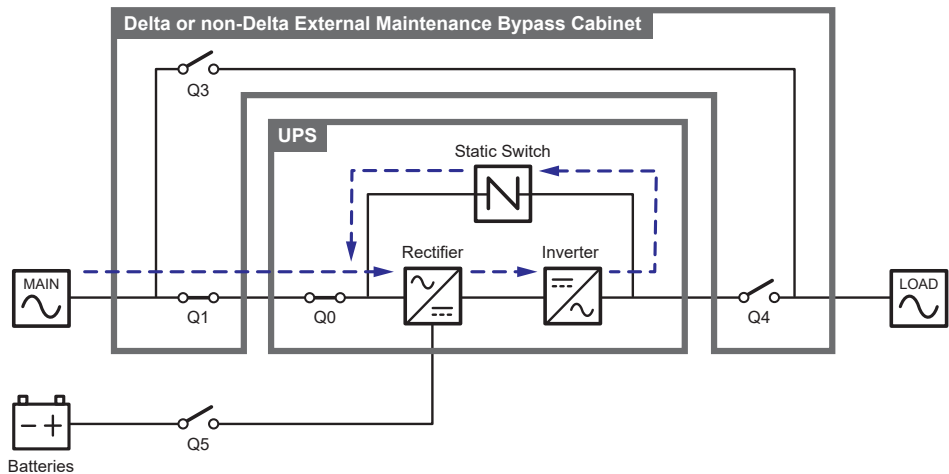

(Figure 3-10: Energy Recycle Mode Diagram_ Single Input Single Unit)

3.1.9 Online Mode_ Single Input_ Parallel Units

In online mode (parallel), the total loads will be equally shared by the parallel UPSs. If one of the parallel units fails and its load is less than the total capacity of the remaining parallel units, the failing UPS's output will be switched off and its load will be equally shared by the remaining parallel units. If the failing UPS's load is larger than the total capacity of the remaining parallel units, all UPSs' inverters will turn off and the total loads will be supplied by bypass power. During online mode, each UPS's tri-color LED illuminates green and each UPS's LCD shows the text 'On-Line' in the upper right corner. Please refer to **Figure 3-11** for the path of electrical power through the parallel UPSs in online mode.

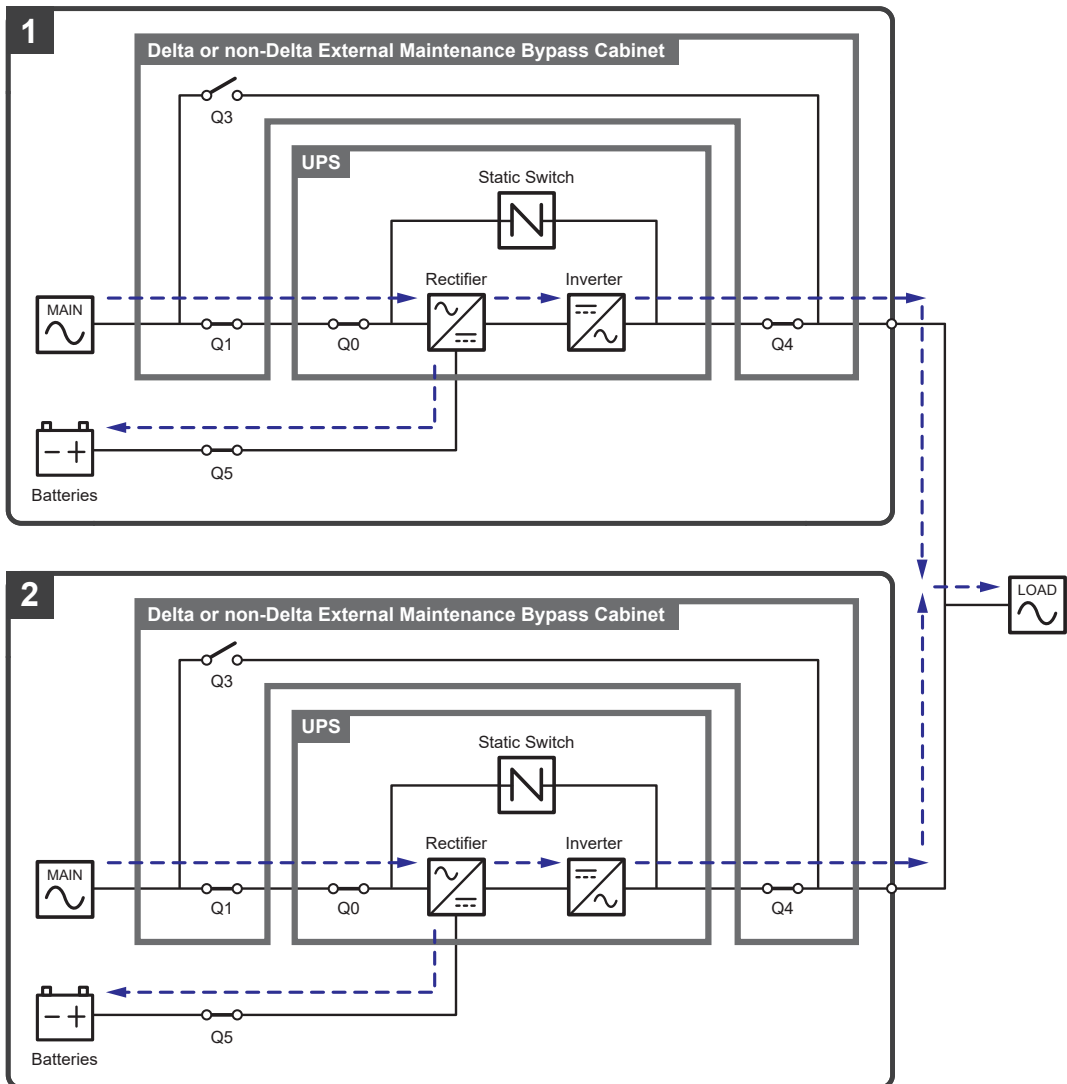

(Figure 3-11: Online Mode Diagram_ Single Input Parallel Units)

3.1.10 Battery Mode _ Single Input_ Parallel Units

If the main AC source cannot supply power, for example, when unstable voltage or a power outage occurs, all parallel UPSs will automatically transfer from online mode to battery mode. During the conversion process, output voltage remains the same, and during battery mode, each UPS's tri-color LED illuminates yellow and each UPS's LCD shows the text 'Battery' in the upper right corner. Please refer to **Figure 3-12** for the path of electrical power through the parallel UPSs in battery mode.

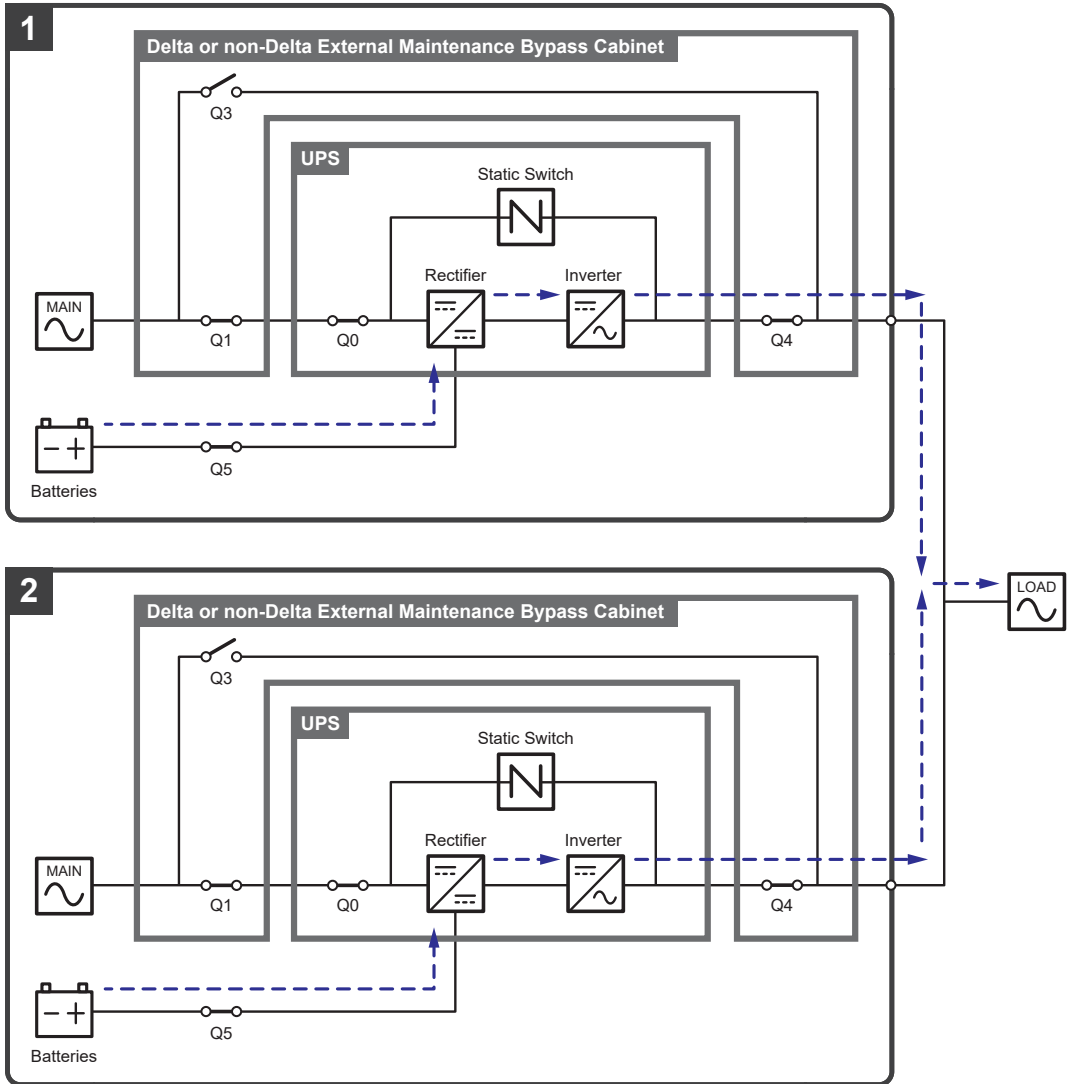
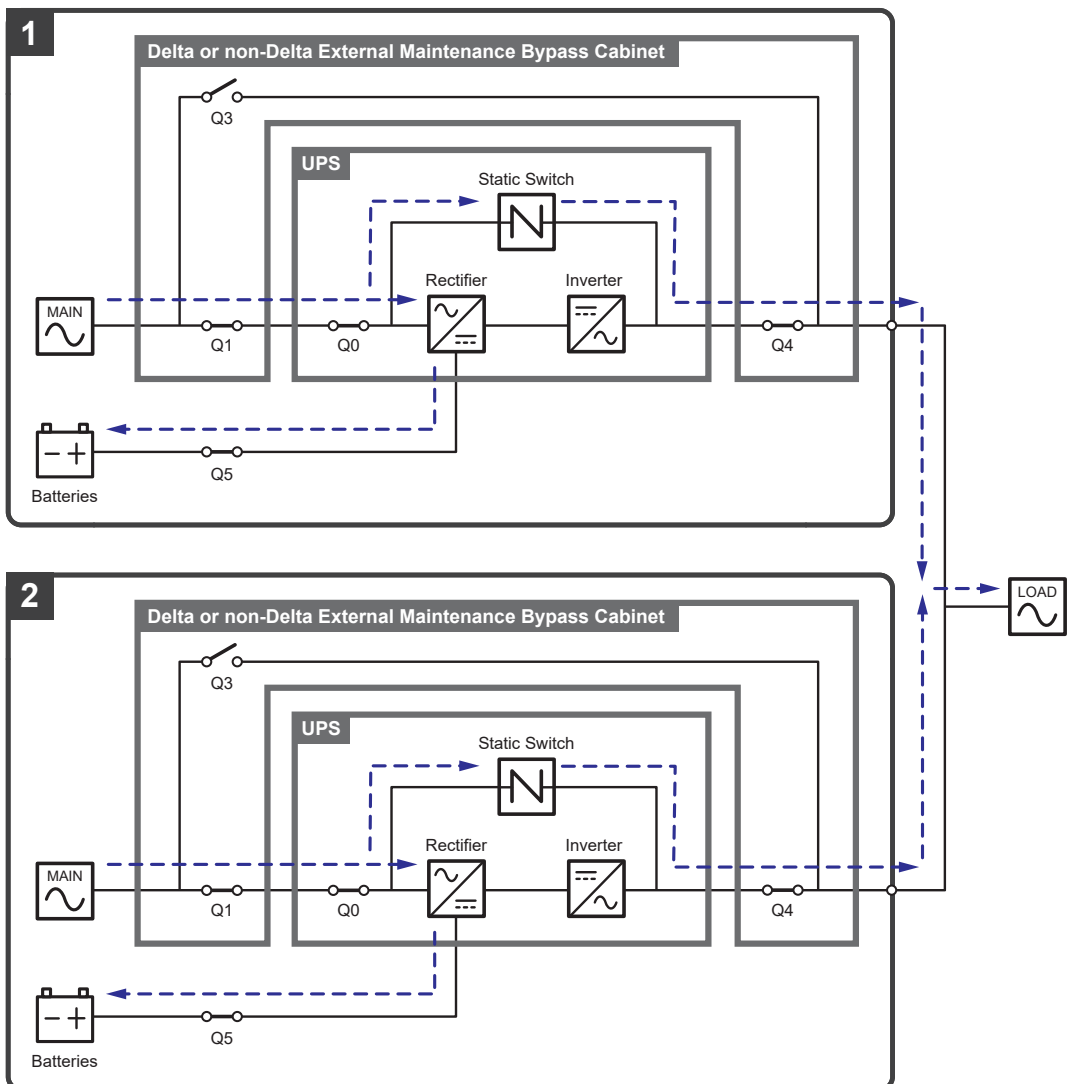

Figure 3-12: Battery Mode Diagram_ Single Input Parallel Units

3.1.11 Bypass Mode_Single Input_Parallel Units

In parallel mode, when all inverters encounter abnormal situations such as overload, short circuit, abnormal output voltage or low battery, they will automatically shut themselves down. Meanwhile, if all UPSs detect the bypass AC source is normal, they will automatically switch to bypass mode to protect the connected critical loads from power interruption. The critical loads will be equally shared by all parallel units. After the abnormalities mentioned above are eliminated, the UPSs will switch back to online mode from bypass mode. During bypass mode, each UPS's tri-color LED illuminates yellow and each UPS's LCD shows the text 'Bypass' in the upper right corner. Please see **Figure 3-13** for the path of electrical power through the parallel UPSs in bypass mode.



(Figure 3-13: Bypass Mode Diagram_Single Input Parallel Units)

3.1.12 Manual Bypass Mode_ Single Input_ Parallel Units

In parallel mode, if one of the parallel UPSs needs maintenance, please first confirm that the bypass AC source and each parallel UPS's STS module are normal. After confirmation, please follow the procedures below to manually switch each of the parallel UPSs to manual bypass mode.

- 1 Press each LCD's ON/ OFF button () once and the 'POWER OFF?' screen will pop up to ask you if you want to power off the inverter. Please select 'YES'.
- 2 Turn on each Delta or non-Delta external maintenance bypass cabinet's Manual Bypass Breaker or Switch (Q3).
- 3 Turn off each UPS's Bypass Switch (Q0).
- 4 Turn off each Delta or non-Delta external maintenance bypass cabinet's Input Breaker or Switch (Q1) and Output Breaker or Switch (Q4).
- 5 Turn off each external battery cabinet's breaker (Q5).

In manual bypass mode, all power inside the parallel UPSs is completely cut off and maintenance personnel can perform maintenance safely. The connected critical loads will be supplied by the manual bypass. During manual bypass mode, all parallel UPSs' tri-color LEDs and LCDs are off. Please see **Figure 3-14** for the path of electrical power through the parallel UPSs in manual bypass mode.



WARNING:

1. In manual bypass mode, make sure that all of the breakers or switches (except each Delta or non-Delta external maintenance bypass cabinet's Manual Bypass Breaker or Switch (Q3)) are in the **OFF** position before working on any of the parallel UPSs' internal circuits. This avoids electric shock.
2. After the power inside all parallel UPSs is completely cut off, there is no high voltage in the parallel UPSs but in every Delta or non-Delta external maintenance bypass cabinet. Do not touch any Delta or non-Delta external maintenance bypass cabinet during UPS maintenance process to avoid electric shock.
3. During manual bypass mode, each parallel UPS's input power is completely cut off and the connected critical loads are not protected.



NOTE: For parallel UPSs, if you want to turn off one of the parallel UPSs for maintenance, please make sure the total connected critical loads will not exceed the remaining parallel units' total capacity.

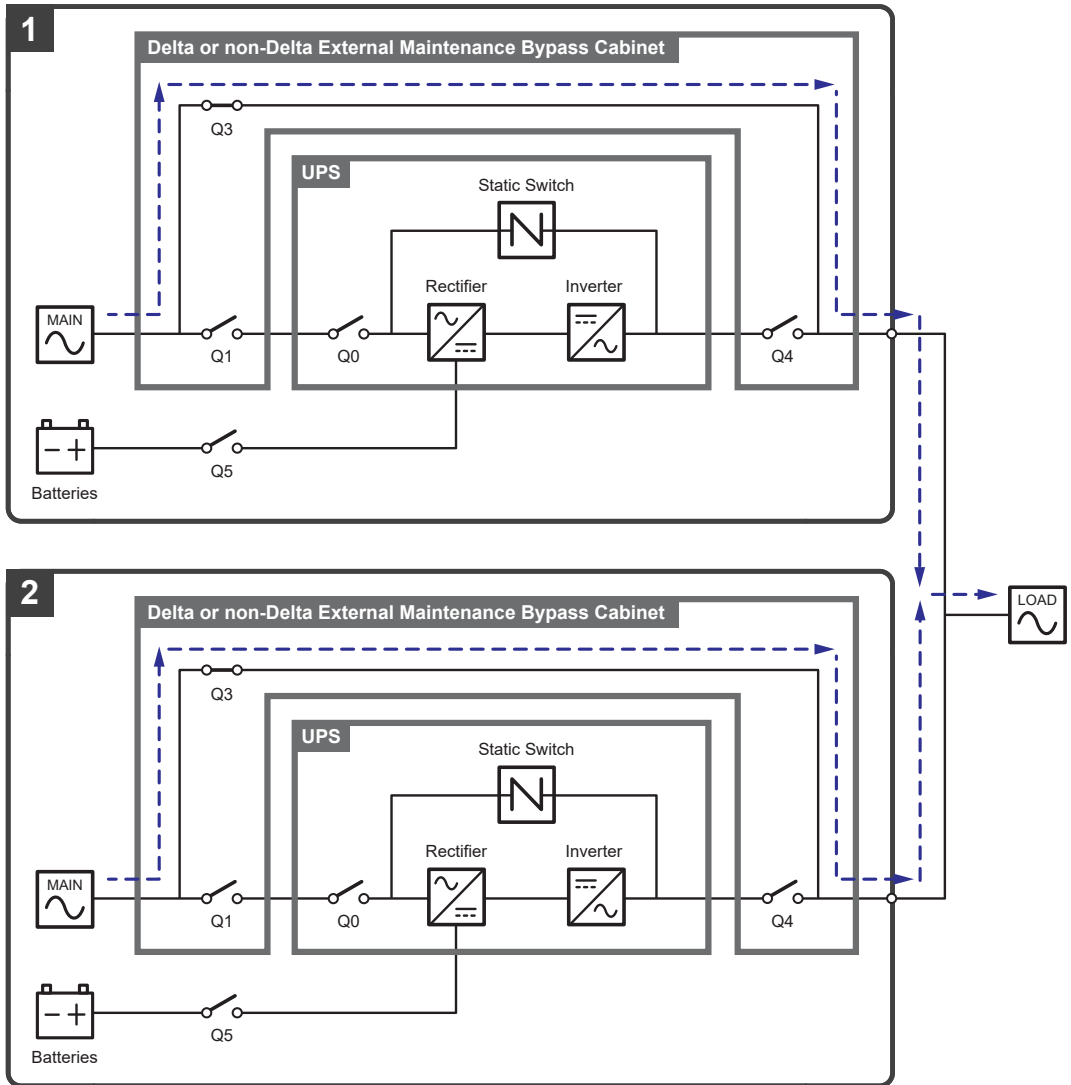

(Figure 3-14: Manual Bypass Mode Diagram_ Single Input Parallel Units)

3.1.13 ECO Mode_ Single Input_ Parallel Units

To activate ECO mode, please refer to **6.2.5 ECO Mode Start-up Procedures**, **7.6 Main Screen** and **7.10.2 Mode Setting**.

In ECO mode (parallel), when each UPS's bypass input voltage and frequency are within the range of rating voltage $\pm 10\%$ and rating frequency $\pm 3\text{Hz}$, each UPS works in bypass mode; otherwise, each UPS runs in online mode. During ECO mode, each UPS's tri-color LED illuminates green and each UPS's LCD shows the text 'ECO' in the upper right corner. Please see **Figure 3-15** for the path of electrical power through the parallel UPSs in ECO mode.

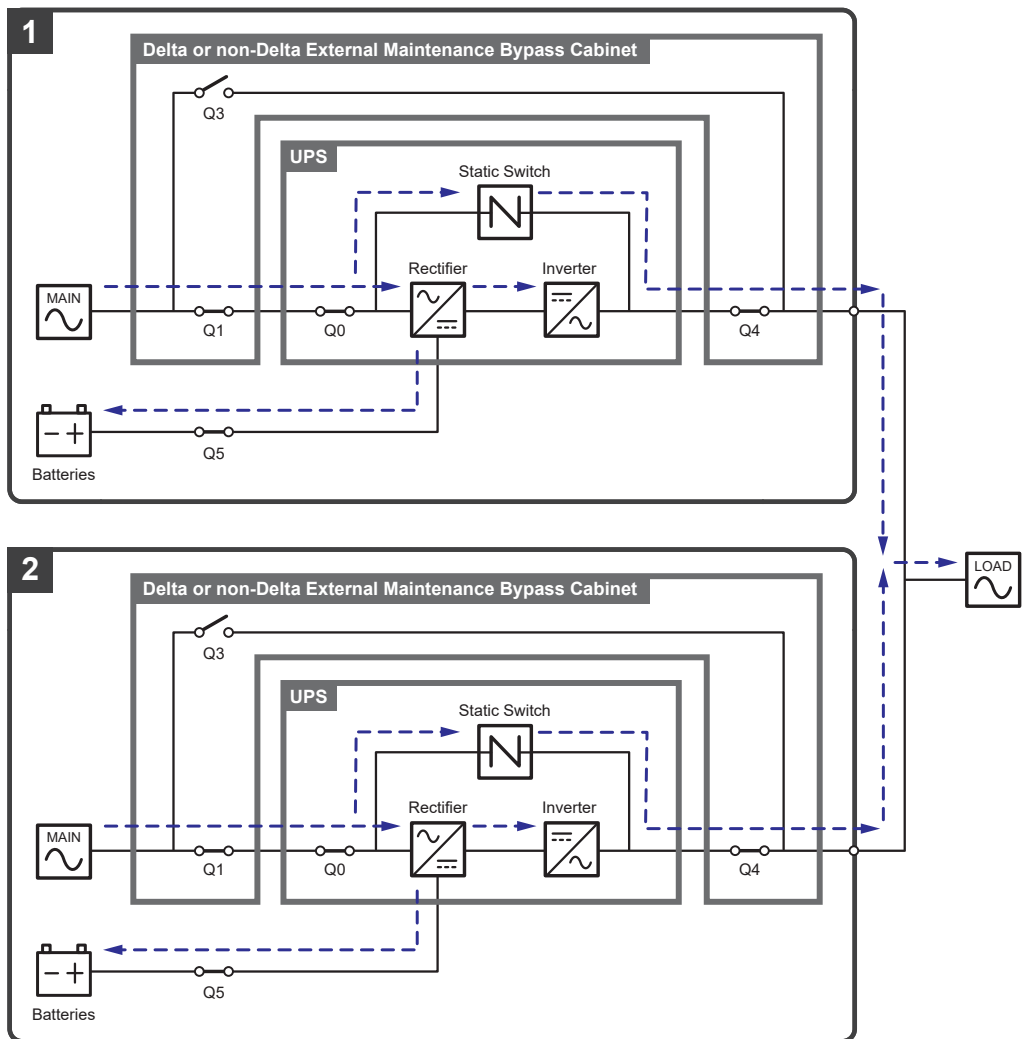

(Figure 3-15: ECO Mode Diagram_ Single Input Parallel Units)

3.1.14 Frequency Conversion Mode_ Single Input_ Parallel Units

To activate frequency conversion mode, please refer to **6.2.6 Frequency Conversion Mode Start-up Procedures**, **7.6 Main Screen** and **7.10.2 Mode Setting**.

For parallel application, after each of the parallel UPSs is manually set in frequency conversion mode, each inverter will automatically select 50Hz or 60Hz as the fixed output frequency. After the output frequency is determined, each system will automatically disable the bypass function. Please note that, once each inverter shuts down, there is no bypass output. During frequency conversion mode, each UPS's tri-color LED illuminates green and each UPS's LCD shows the text '**Frequency Conversion**' in the upper right corner. Please see **Figure 3-16** for the path of electrical power through the parallel UPSs in frequency conversion mode.



NOTE: During frequency conversion mode (parallel), once all of the UPSs' inverters shut down, there is no bypass output.

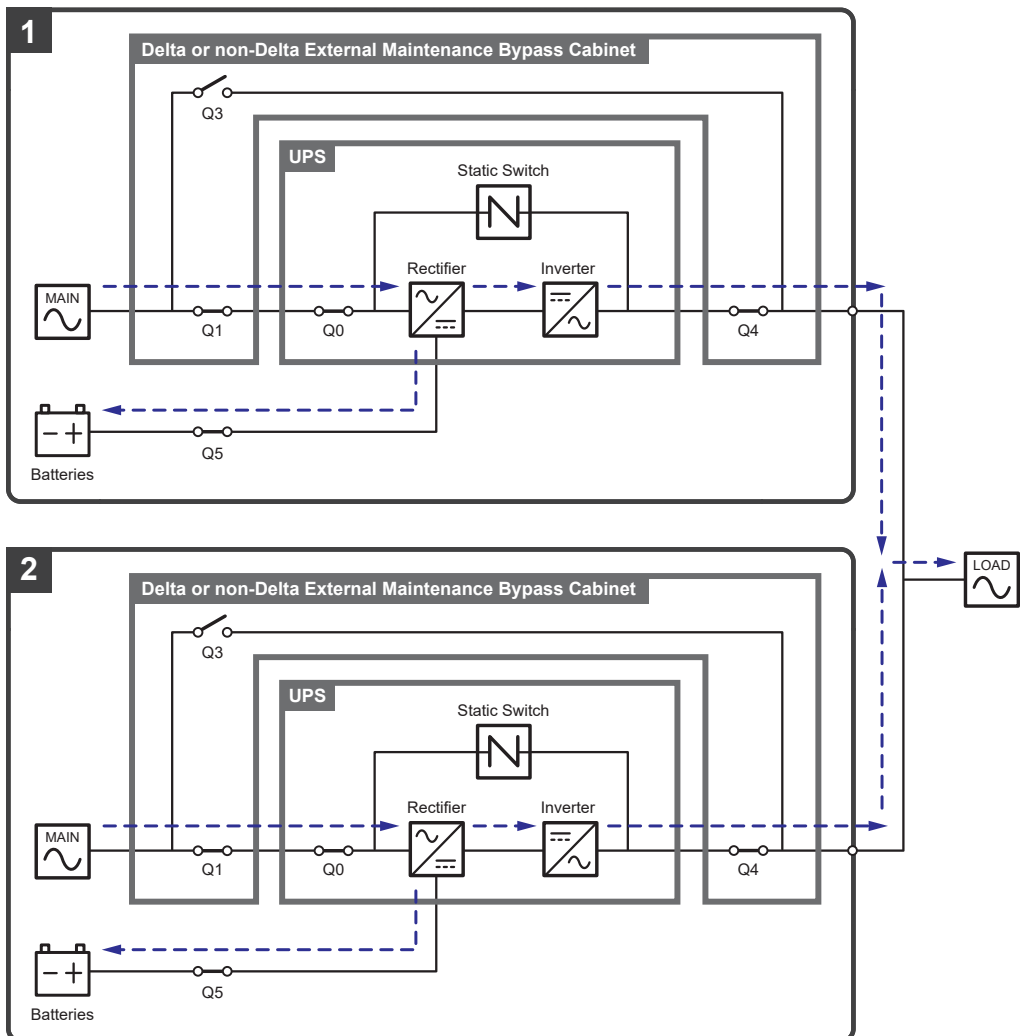

(Figure 3-16: Frequency Conversion Mode Diagram_ Single Input Parallel Units)

3.1.15 Green Mode_ Single Input_ Parallel Units

To activate green mode, please refer to **6.2.7 Green Mode Start-up Procedures**, **7.6 Main Screen** and **7.10.2 Mode Setting**.

For parallel application, green mode is the same as online mode, but the difference is that each system will automatically detect its UPS's output status (i.e. total load capacity %) to decide which specific power modules should be fully powered on or idle in order to achieve higher efficiency of the UPS. During green mode, each UPS's tri-color LED illuminates green and each UPS's LCD shows the text 'Green' in the upper right corner. Please see **Figure 3-17** for the path of electrical power through the parallel UPSs in green mode.

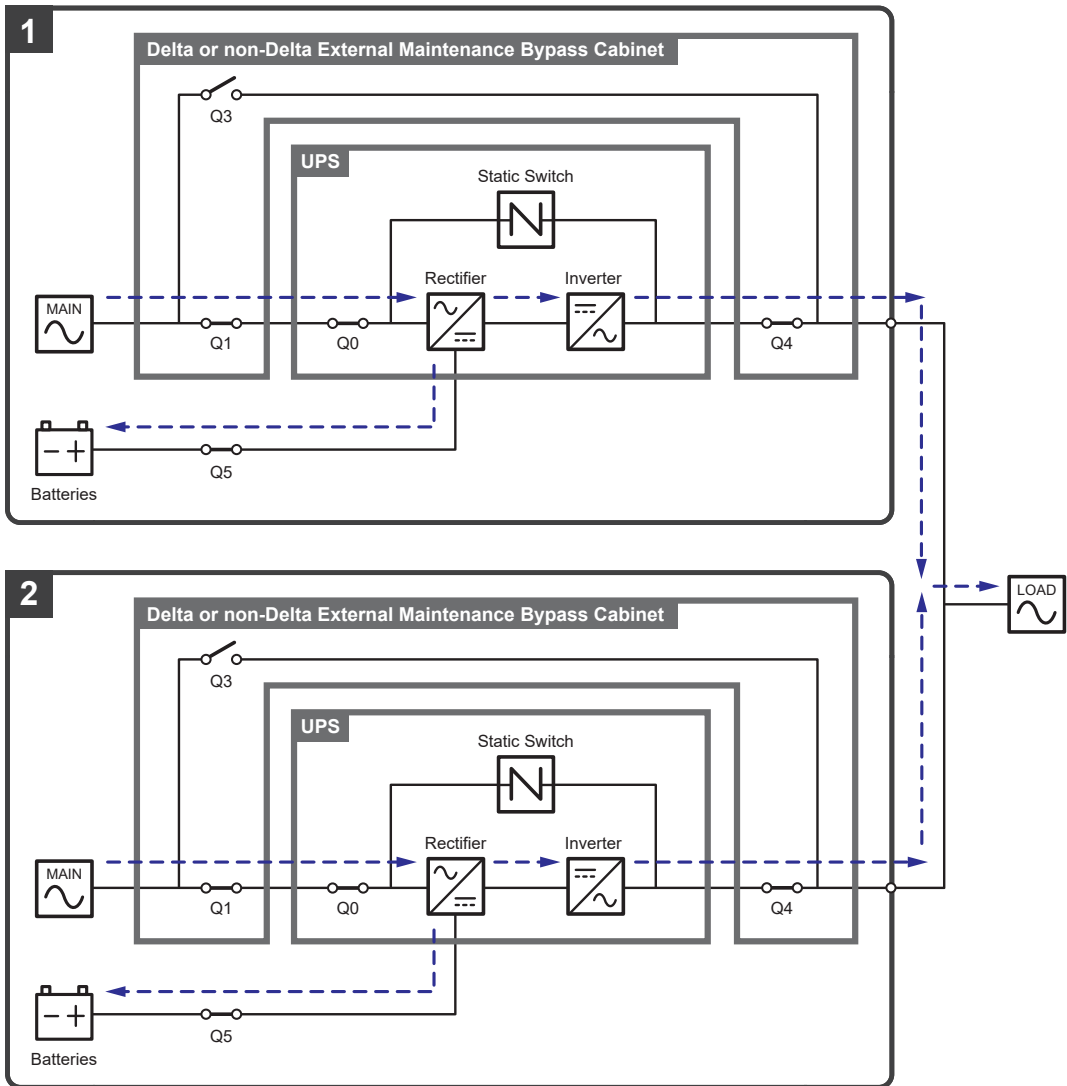

(Figure 3-17: Green Mode Diagram_ Single Input Parallel Units)

3.2 Dual Input

3.2.1 Online Mode_ Dual Input_ Single Unit

In online mode, the main AC source supplies AC power via the Delta or non-Delta external maintenance bypass cabinet's Input Breaker or Switch (Q1) to the rectifier and the rectifier converts the AC power to DC power and supplies the DC power to the inverter. In the meantime, the rectifier provides charging power to the batteries. After receiving the DC power, the inverter converts it into clean and stable AC power to the connected critical loads via the Delta or non-Delta external maintenance bypass cabinet's Output Breaker or Switch (Q4). Please see **Figure 3-18** for online mode diagram. During online mode, the UPS's tri-color LED illuminates green and the text '**On-Line**' appears in the upper right corner of the screen.

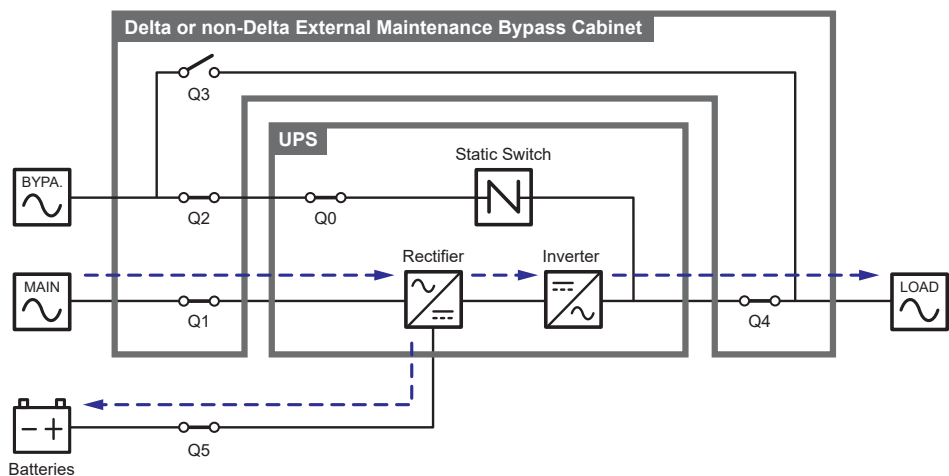

(Figure 3-18: Online Mode Diagram_ Dual Input Single Unit)

3.2.2 Battery Mode_ Dual Input_ Single Unit

The UPS transfers to battery mode automatically if the main AC source cannot supply power, for example, when unstable voltage or a power outage occurs. In battery mode, the batteries provide DC power and the UPS converts it into AC power and supplies it to the connected critical loads via the Delta or non-Delta external maintenance bypass cabinet's Output Breaker or Switch (Q4). During the conversion process, output voltage remains the same. Please see **Figure 3-19** for battery mode diagram. During battery mode, the UPS's tri-color LED illuminates yellow and the text '**Battery**' appears in the upper right corner of the screen.

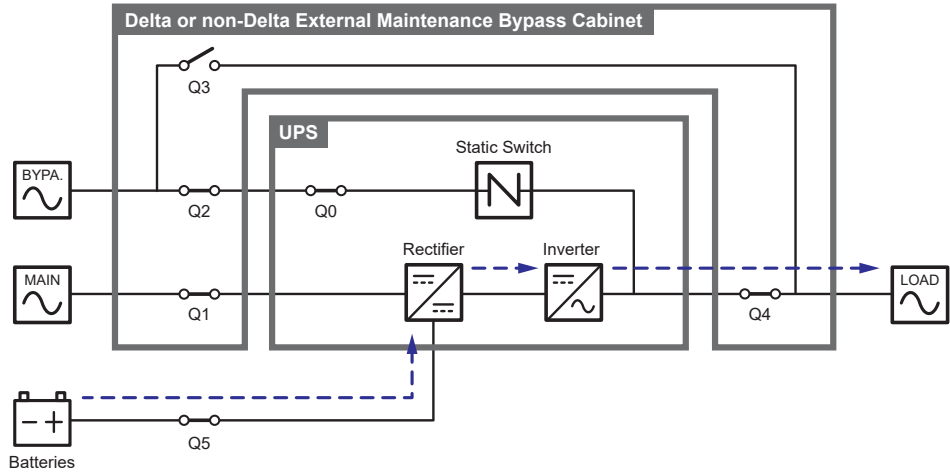

(Figure 3-19: Battery Mode Diagram_Dual Input Single Unit)

3.2.3 Bypass Mode_Dual Input_Single Unit

When the inverter encounters abnormal situations such as over temperature, overload, short circuit, abnormal output voltage or low battery, it will automatically shut itself down. If the UPS detects the bypass AC source is normal, it will automatically switch to bypass mode to protect the connected critical loads from power interruption. Please refer to **Figure 3-20**. After the above-mentioned abnormalities are eliminated, the UPS will switch back to online mode from bypass mode. During bypass mode, the UPS's tri-color LED illuminates yellow and the text 'Bypass' appears in the upper right corner of the screen.

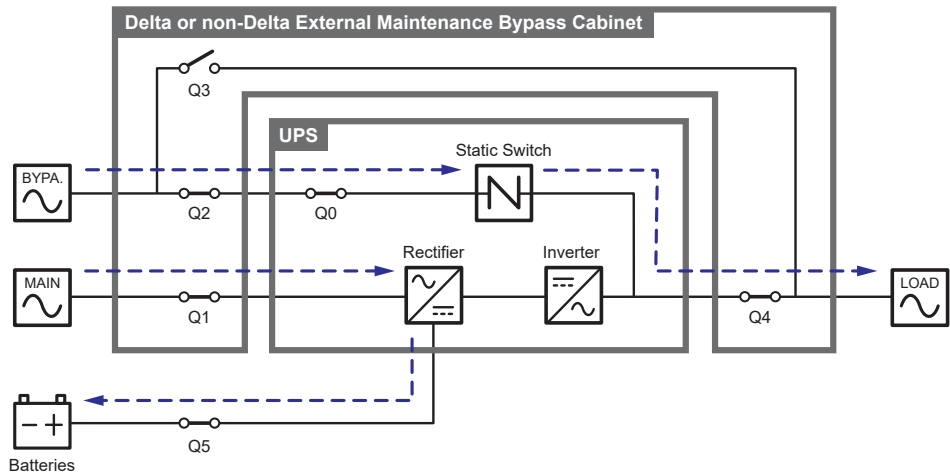

(Figure 3-20: Bypass Mode Diagram_Dual Input Single Unit)

3.2.4 Manual Bypass Mode_ Dual Input_ Single Unit

When the UPS needs maintenance, you can manually switch the UPS to manual bypass mode. To let the UPS run in manual bypass mode, please follow the procedures below:

- 1 Confirm that the bypass AC source and the STS module are normal.
- 2 Press the LCD's ON/ OFF button () once and the 'POWER OFF?' screen will pop up to ask you if you want to power off the inverter. Please select 'YES'.
- 3 Turn on the Delta or non-Delta external maintenance bypass cabinet's Manual Bypass Breaker or Switch (Q3).
- 4 Turn off the UPS's Bypass Switch (Q0).
- 5 Turn off the Delta or non-Delta external maintenance bypass cabinet's Input Breaker or Switch (Q1), Bypass Breaker or Switch (Q2) and Output Breaker or Switch (Q4).
- 6 Turn off each external battery cabinet's breaker (Q5).

In manual bypass mode, all power inside the UPS is completely cut off and maintenance personnel can perform maintenance safely. For manual bypass mode diagram, please see **Figure 3-21**. During manual bypass mode, the UPS's tri-color LED and LCD are both off.



WARNING:

1. In manual bypass mode, make sure that all of the breakers or switches (except the Delta or non-Delta external maintenance bypass cabinet's Manual Bypass Breaker or Switch (Q3)) are in the **OFF** position before working on the UPS's internal circuits. This avoids electric shock.
2. After the power inside the UPS is completely cut off, there is no high voltage in the UPS but in the Delta or non-Delta external maintenance bypass cabinet. Do not touch the Delta or non-Delta external maintenance bypass cabinet during UPS maintenance process to avoid electric shock.
3. During manual bypass mode, the UPS's input power is completely cut off and the connected critical loads are not protected.

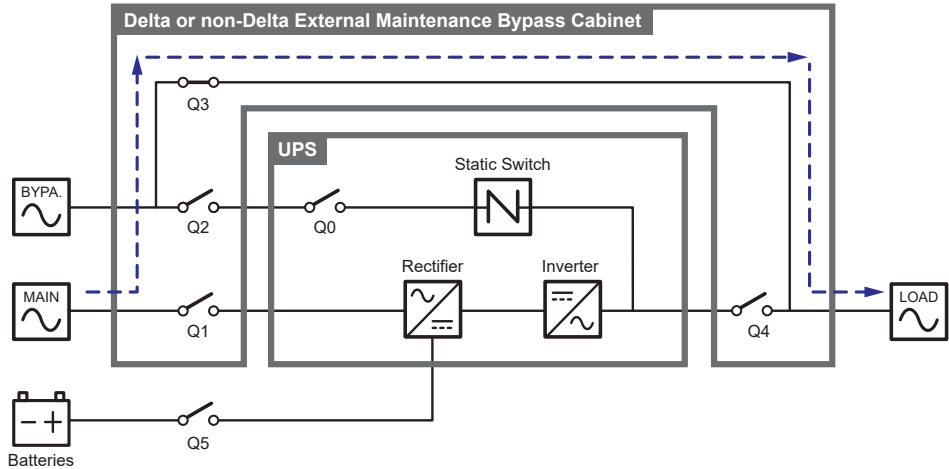

(Figure 3-21: Manual Bypass Mode Diagram_ Dual Input Single Unit)

3.2.5 ECO Mode_ Dual Input_ Single Unit

To activate ECO mode, please refer to **6.2.5 ECO Mode Start-up Procedures**, **7.6 Main Screen** and **7.10.2 Mode Setting**.

In ECO mode, when the bypass AC source's input voltage and frequency are within the range of rating voltage $\pm 10\%$ and rating frequency $\pm 3\text{Hz}$, the UPS works in bypass mode; otherwise, the UPS runs in online mode. For ECO mode diagram, please see **Figure 3-22**. During ECO mode, the UPS's tri-color LED illuminates green and the text 'ECO' appears in the upper right corner of the screen.

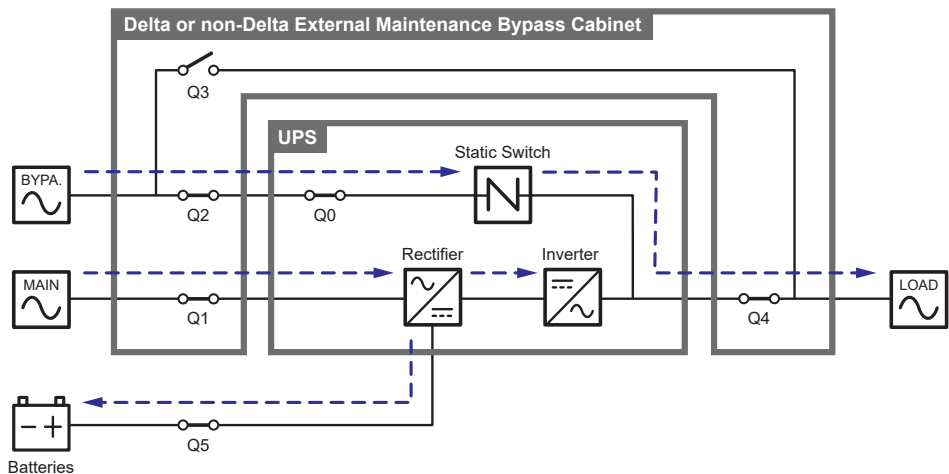

(Figure 3-22: ECO Mode Diagram_ Dual Input Single Unit)

3.2.6 Frequency Conversion Mode_ Dual Input_ Single Unit

To activate frequency conversion mode, please refer to **6.2.6 Frequency Conversion Mode Start-up Procedures**, **7.6 Main Screen** and **7.10.2 Mode Setting**.

After the UPS is manually set in frequency conversion mode, the inverter will automatically select 50Hz or 60Hz as the fixed output frequency. After the output frequency is determined, the system will automatically disable the bypass function. Please note that, once the inverter shuts down, there is no bypass output. For the diagram of frequency conversion mode, please see **Figure 3-23**. During frequency conversion mode, the UPS's tri-color LED illuminates green and the text 'Frequency Conversion' appears in the upper right corner of the screen.



NOTE: During frequency conversion mode, once the inverter shuts down, there is no bypass output.

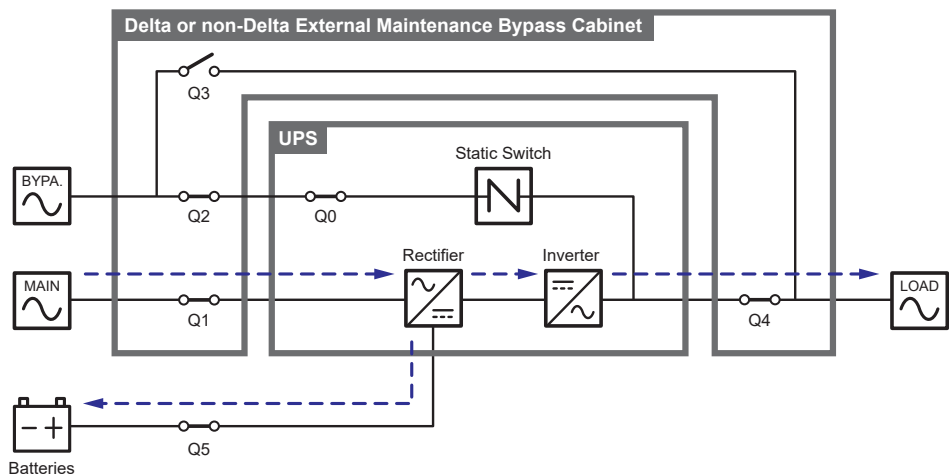

(Figure 3-23: Frequency Conversion Mode Diagram_ Dual Input Single Unit)

3.2.7 Green Mode _ Dual Input_ Single Unit

To activate green mode, please refer to **6.2.7 Green Mode Start-up Procedures**, **7.6 Main Screen** and **7.10.2 Mode Setting**.

Green mode is the same as online mode, but the difference is that the system will automatically detect the output status (i.e. total load capacity %) to decide which specific power modules should be fully powered on or idle in order to achieve higher efficiency of the UPS. For the green mode diagram, please see **Figure 3-24**. During green mode, the UPS's tri-color LED illuminates green and the text 'Green' appears in the upper right corner of the screen.

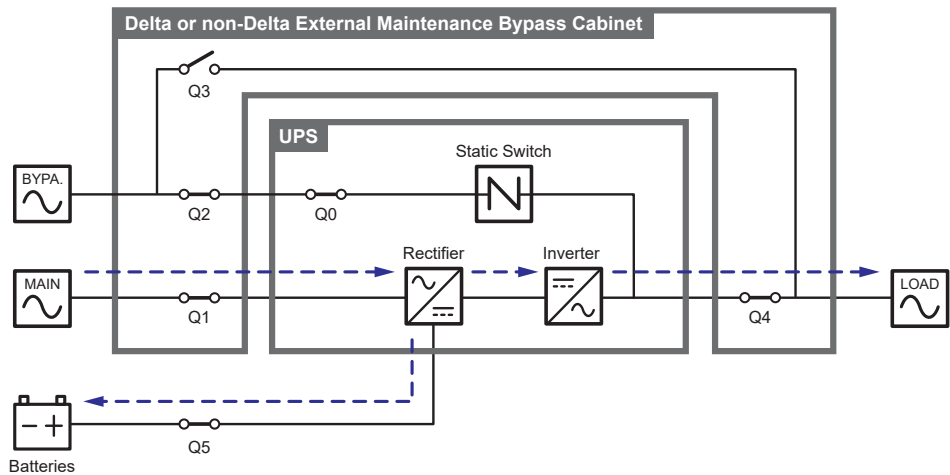

(Figure 3-24: Green Mode Diagram_ Dual Input Single Unit)

3.2.8 Online Mode_Dual Input_Parallel Units

In online mode (parallel), the total loads will be equally shared by the parallel UPSs. If one of the parallel units fails and its load is less than the total capacity of the remaining parallel units, the failing UPS's output will be switched off and its load will be equally shared by the remaining parallel units. If the failing UPS's load is larger than the total capacity of the remaining parallel units, all UPSs' inverters will turn off and the total loads will be supplied by bypass power. During online mode, each UPS's tri-color LED illuminates green and each UPS's LCD shows the text 'On-Line' in the upper right corner. Please refer to **Figure 3-25** for the path of electrical power through the parallel UPSs in online mode.

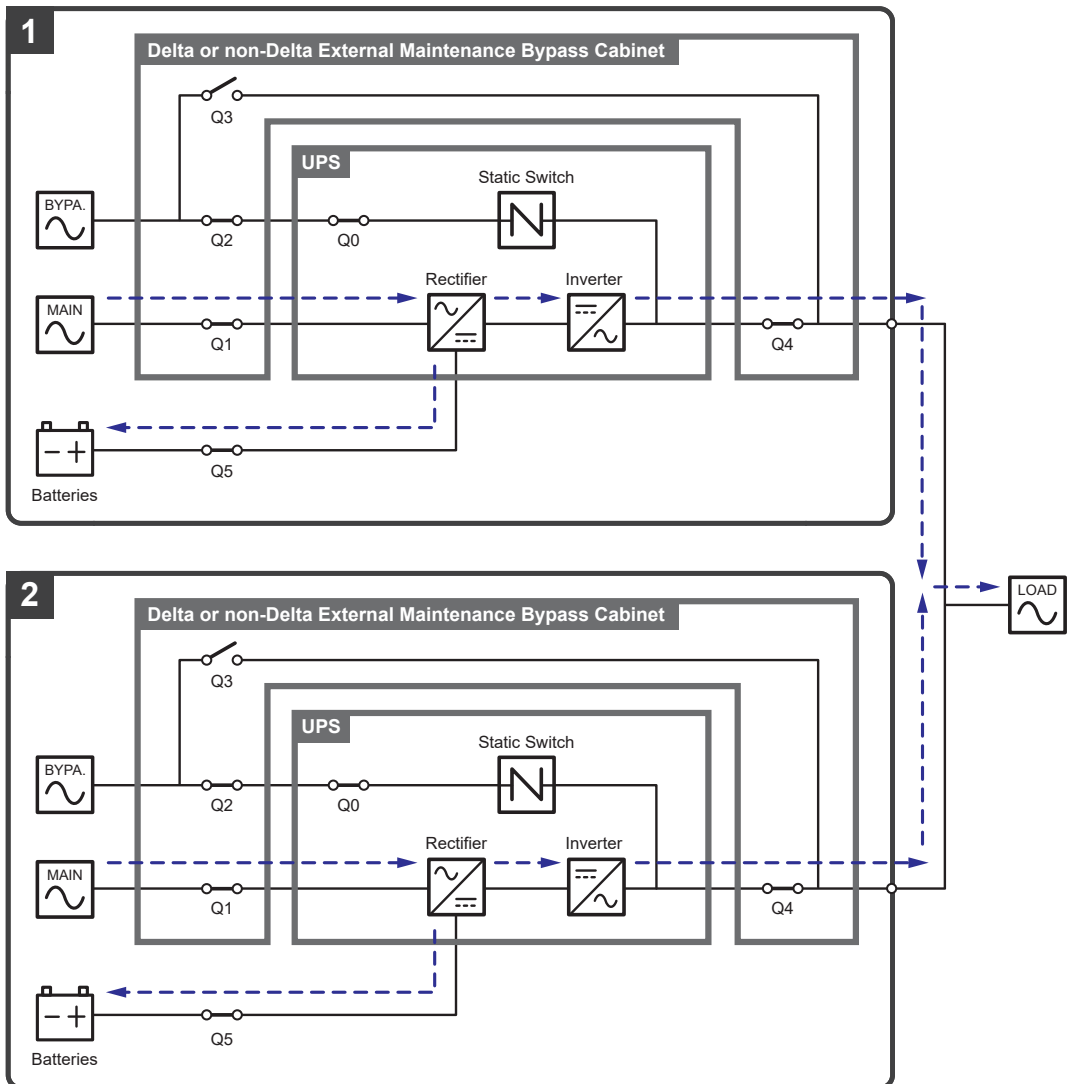

(Figure 3-25: Online Mode Diagram_Dual Input Parallel Units)

3.2.9 Battery Mode _ Dual Input_ Parallel Units

If the main AC source cannot supply power, for example, when unstable voltage or a power outage occurs, all parallel UPSs will automatically transfer from online mode to battery mode. During the conversion process, output voltage remains the same, and during battery mode, each UPS's tri-color LED illuminates yellow and each UPS's LCD shows the text 'Battery' in the upper right corner. Please refer to **Figure 3-26** for the path of electrical power through the parallel UPSs in battery mode.

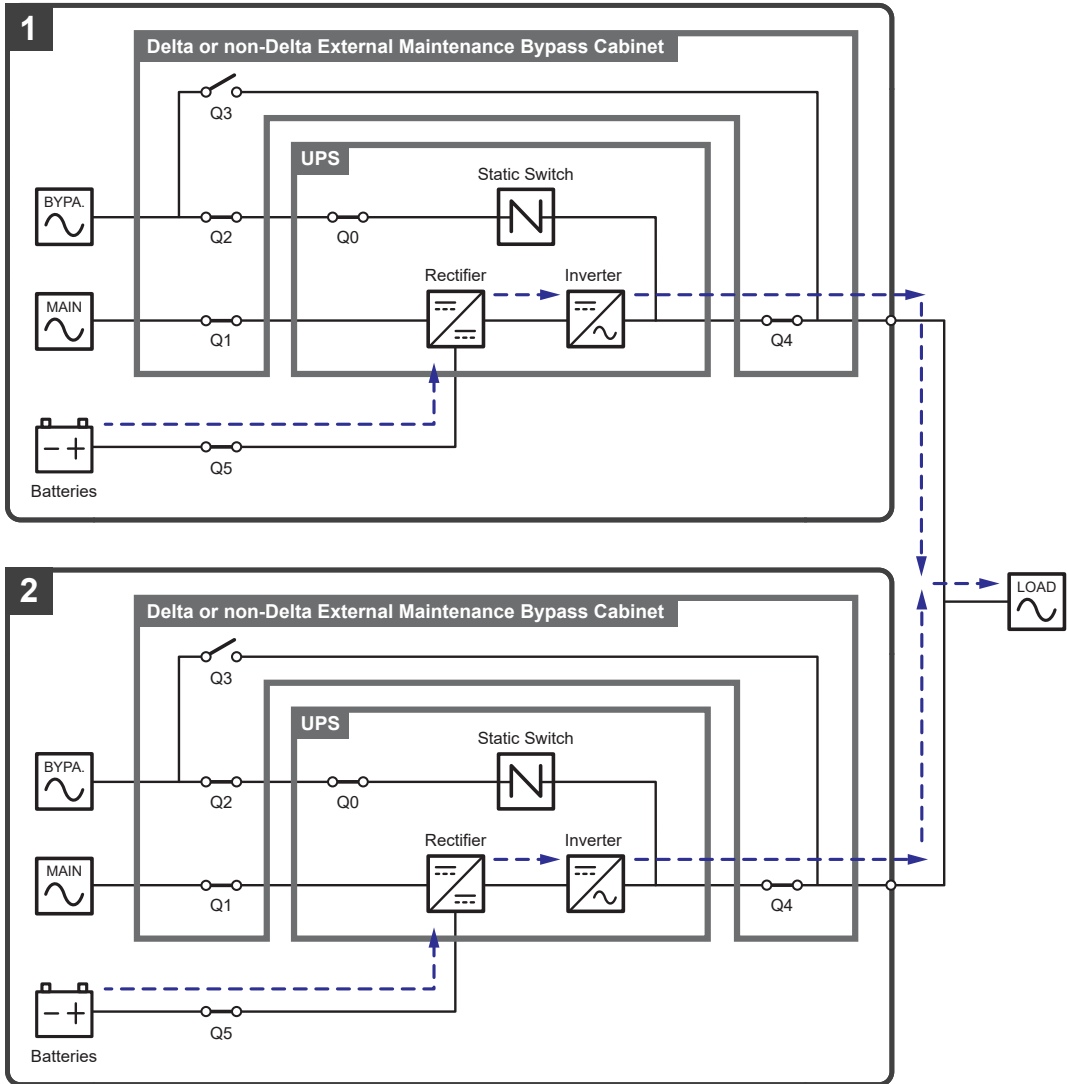

(Figure 3-26: Battery Mode Diagram_ Dual Input Parallel Units)

3.2.10 Bypass Mode_ Dual Input_ Parallel Units

In parallel mode, when all inverters encounter abnormal situations such as overload, short circuit, abnormal output voltage or low battery, they will automatically shut themselves down. Meanwhile, if all UPSs detect the bypass AC source is normal, they will automatically switch to bypass mode to protect the connected critical loads from power interruption. The critical loads will be equally shared by all parallel units. After the abnormalities mentioned above are eliminated, the UPSs will switch back to online mode from bypass mode. During bypass mode, each UPS's tri-color LED illuminates yellow and each UPS's LCD shows the text 'Bypass' in the upper right corner. Please see **Figure 3-27** for the path of electrical power through the parallel UPSs in bypass mode.

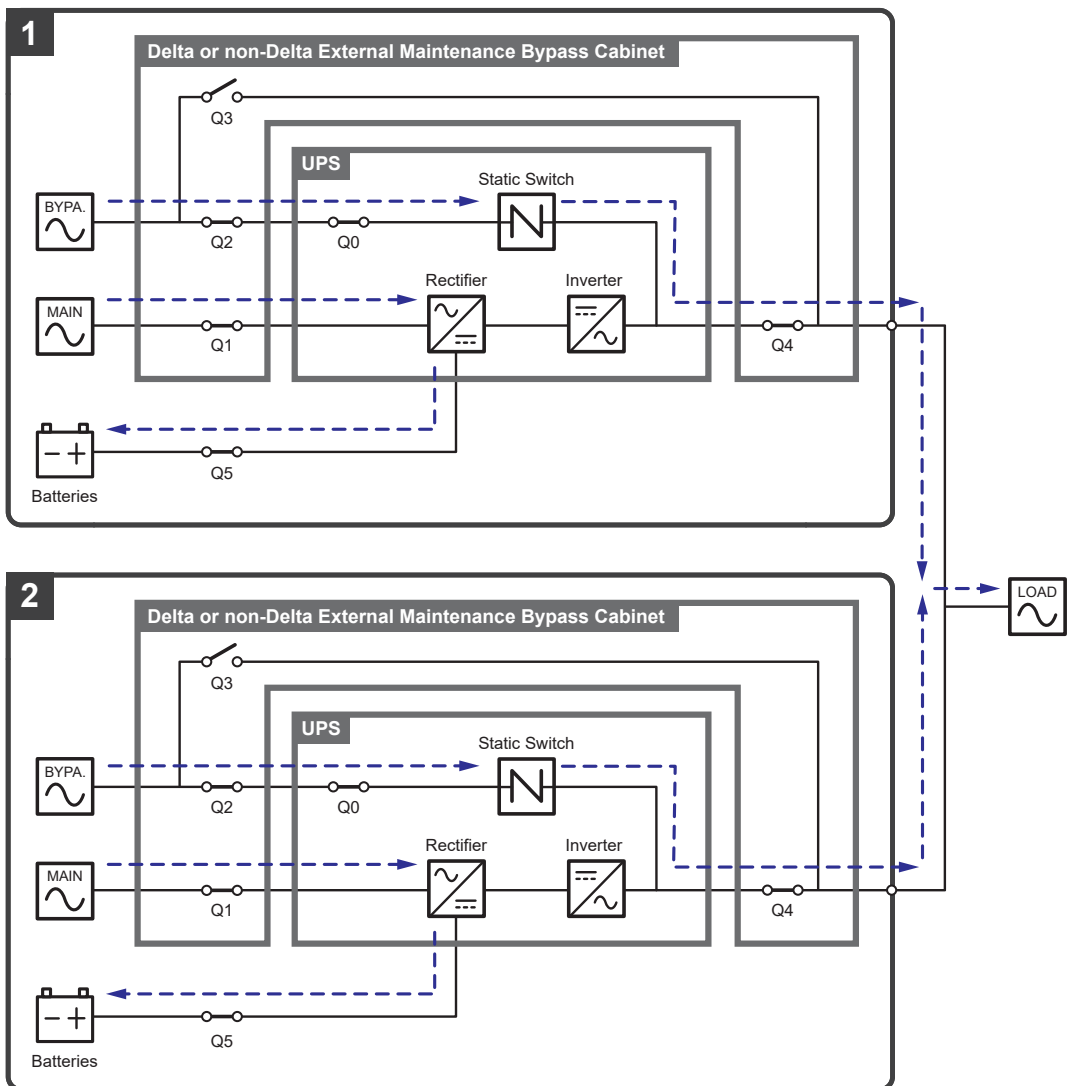

(Figure 3-27: Bypass Mode Diagram_ Dual Input Parallel Units)

3.2.11 Manual Bypass Mode_ Dual Input_ Parallel Units

In parallel mode, if one of the parallel UPSs needs maintenance, please first confirm that the bypass AC source and each parallel UPS's STS module are normal. After confirmation, please follow the procedures below to manually switch each of the parallel UPSs to manual bypass mode.

- 1 Press each LCD's ON/ OFF button () once and the 'POWER OFF?' screen will pop up to ask you if you want to power off the inverter. Please select 'YES'.
- 2 Turn on each Delta or non-Delta external maintenance bypass cabinet's Manual Bypass Breaker or Switch (Q3).
- 3 Turn off each UPS's Bypass Switch (Q0).
- 4 Turn off each Delta or non-Delta external maintenance bypass cabinet's Input Breaker or Switch (Q1), Bypass Breaker or Switch (Q2) and Output Breaker or Switch (Q4).
- 5 Turn off each external battery cabinet's breaker (Q5).

In manual bypass mode, all power inside the parallel UPSs is completely cut off and maintenance personnel can perform maintenance safely. The connected critical loads will be supplied by the manual bypass. During manual bypass mode, all parallel UPSs' tri-color LEDs and LCDs are off. Please see **Figure 3-28** for the path of electrical power through the parallel UPSs in manual bypass mode.



WARNING:

1. In manual bypass mode, make sure that all of the breakers or switches (except each Delta or non-Delta external maintenance bypass cabinet's Manual Bypass Breaker or Switch (Q3)) are in the **OFF** position before working on any of the parallel UPSs' internal circuits. This avoids electric shock.
2. After the power inside all parallel UPSs is completely cut off, there is no high voltage in the parallel UPSs but in every Delta or non-Delta external maintenance bypass cabinet. Do not touch any Delta or non-Delta external maintenance bypass cabinet during UPS maintenance process to avoid electric shock.
3. During manual bypass mode, each parallel UPS's input power is completely cut off and the connected critical loads are not protected.



NOTE: For parallel UPSs, if you want to turn off one of the parallel UPSs for maintenance, please make sure the total connected critical loads will not exceed the remaining parallel units' total capacity.

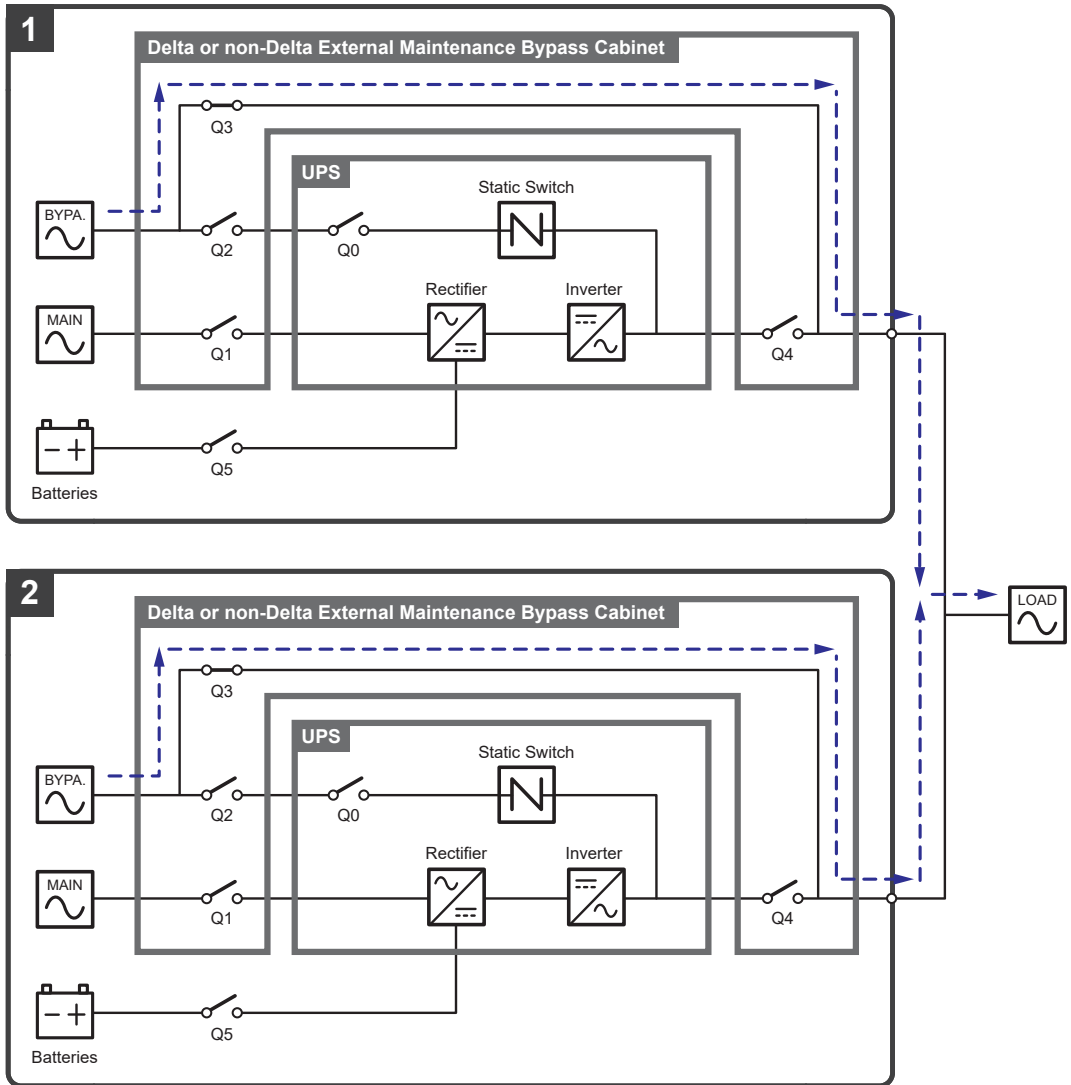

(Figure 3-28: Manual Bypass Mode Diagram_ Dual Input Parallel Units)

3.2.12 ECO Mode_ Dual Input_ Parallel Units

To activate ECO mode, please refer to **6.2.5 ECO Mode Start-up Procedures**, **7.6 Main Screen** and **7.10.2 Mode Setting**.

In ECO mode (parallel), when each UPS's bypass input voltage and frequency are within the range of rating voltage $\pm 10\%$ and rating frequency $\pm 3\text{Hz}$, each UPS works in bypass mode; otherwise, each UPS runs in online mode. During ECO mode, each UPS's tri-color LED illuminates green and each UPS's LCD shows the text 'ECO' in the upper right corner. Please see **Figure 3-29** for the path of electrical power through the parallel UPSs in ECO mode.

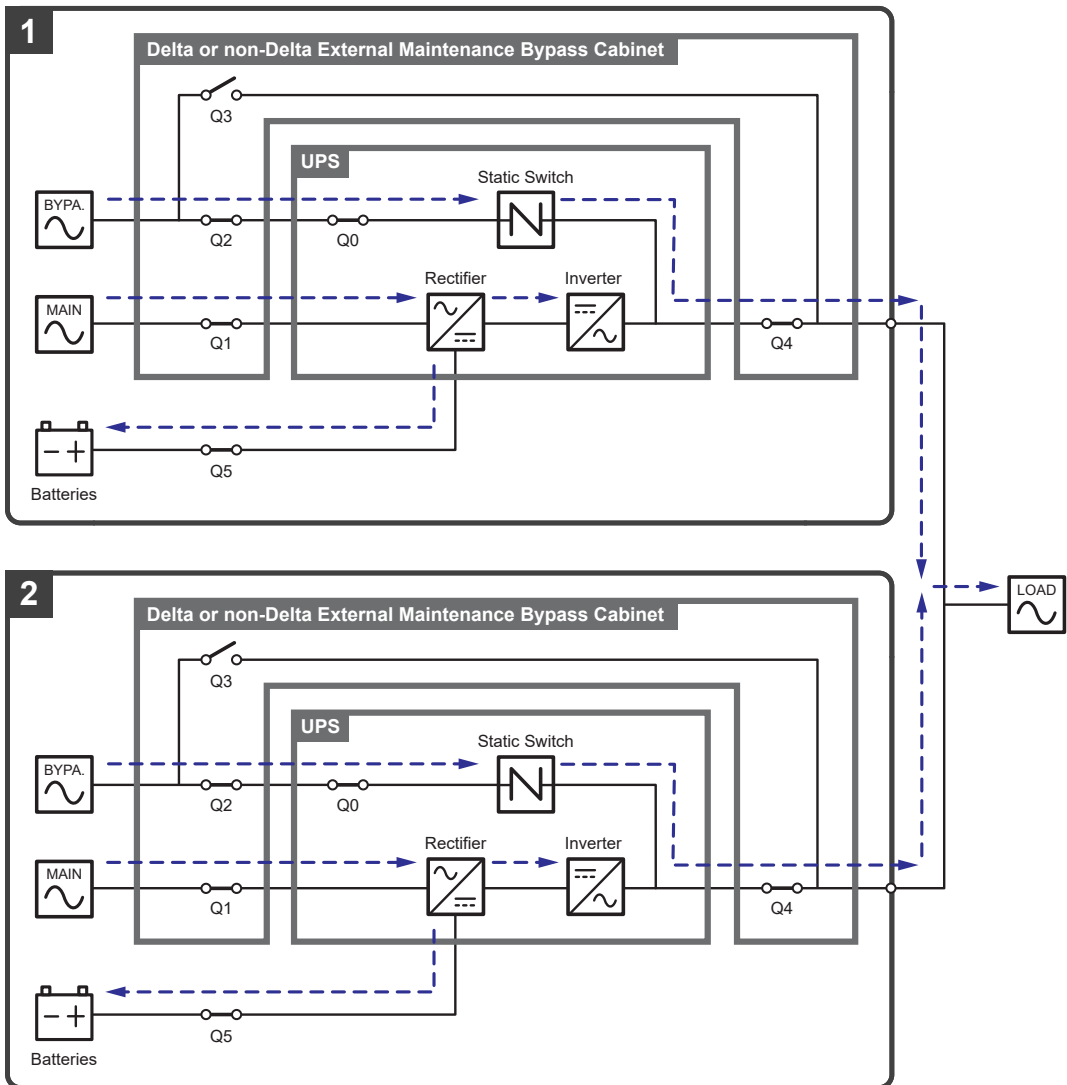

(Figure 3-29: ECO Mode Diagram_ Dual Input Parallel Units)

3.2.13 Frequency Conversion Mode_ Single Input_ Parallel Units

To activate frequency conversion mode, please refer to **6.2.6 Frequency Conversion Mode Start-up Procedures**, **7.6 Main Screen** and **7.10.2 Mode Setting**.

For parallel application, after each of the parallel UPSs is manually set in frequency conversion mode, each inverter will automatically select 50Hz or 60Hz as the fixed output frequency. After the output frequency is determined, each system will automatically disable the bypass function. Please note that, once each inverter shuts down, there is no bypass output. During frequency conversion mode, each UPS's tri-color LED illuminates green and each UPS's LCD shows the text 'Frequency Conversion' in the upper right corner. Please see **Figure 3-30** for the path of electrical power through the parallel UPSs in frequency conversion mode.



NOTE: During frequency conversion mode (parallel), once all of the UPSs' inverters shut down, there is no bypass output.

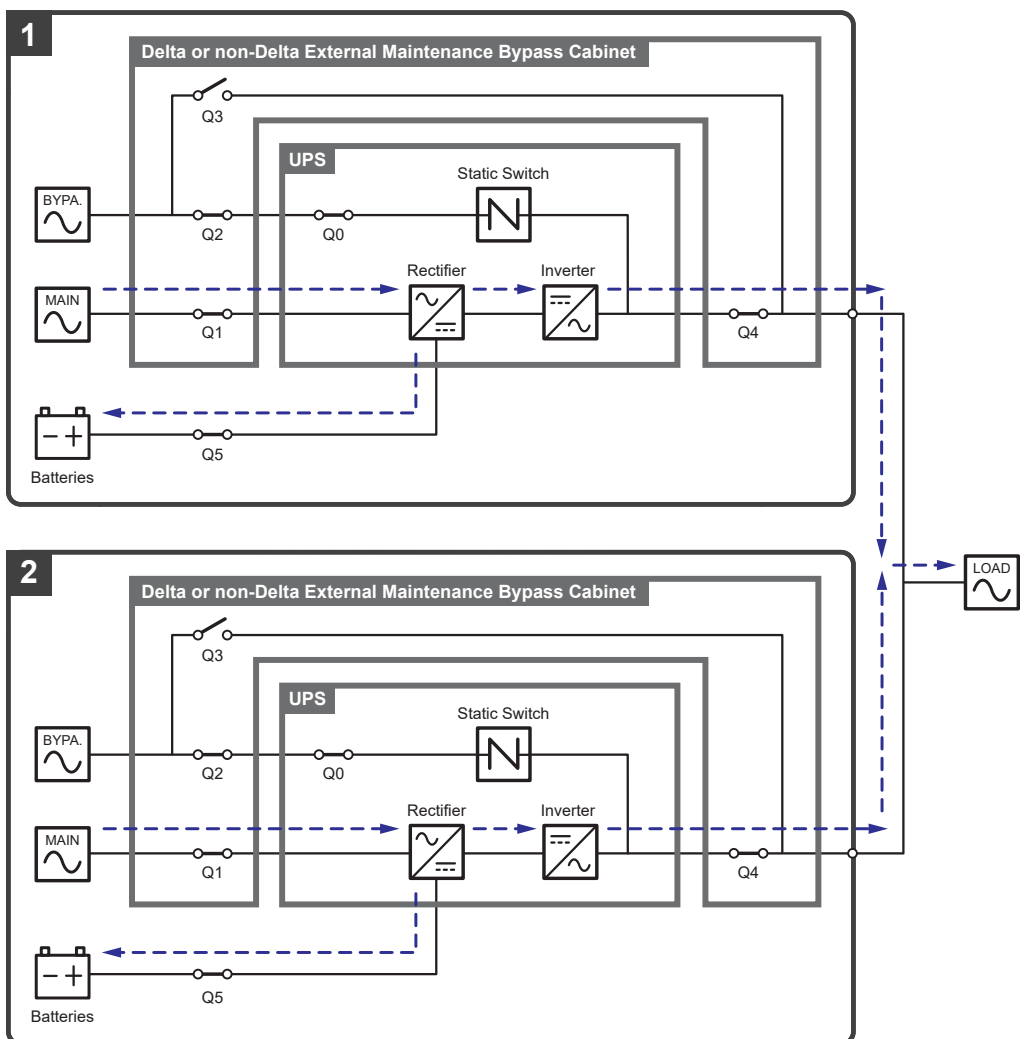

(Figure 3-30: Frequency Conversion Mode Diagram_ Dual Input Parallel Units)

3.2.14 Green Mode_ Dual Input_ Parallel Units

To activate green mode, please refer to **6.2.7 Green Mode Start-up Procedures**, **7.6 Main Screen** and **7.10.2 Mode Setting**.

For parallel application, green mode is the same as online mode, but the difference is that each system will automatically detect its UPS's output status (i.e. total load capacity %) to decide which specific power modules should be fully powered on or idle in order to achieve higher efficiency of the UPS. During green mode, each UPS's tri-color LED illuminates green and each UPS's LCD shows the text 'Green' in the upper right corner. Please see **Figure 3-31** for the path of electrical power through the parallel UPSs in green mode.

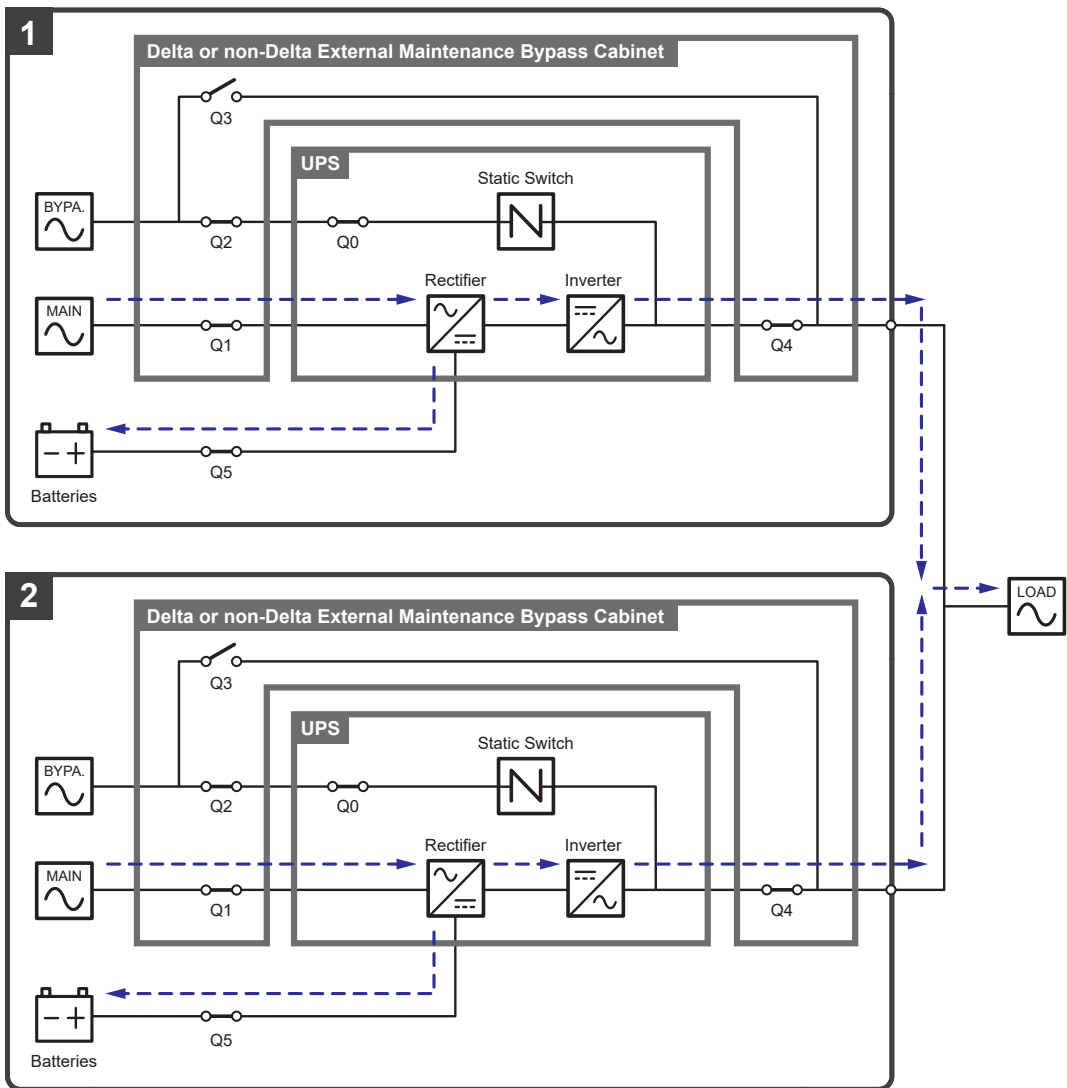

(Figure 3-31: Green Mode Diagram_ Dual Input Parallel Units)

3.3 Hot Standby Redundancy (Only For Dual Input & At Least Two UPSs)

To provide customers more application choices, the UPS with a dual-input configuration can have a hot standby redundancy function. If you use two UPSs and wish them to work in hot standby redundancy mode, please connect the output of UPS1 to the bypass AC source of UPS 2. Please see **Figure 3-23**. For more information about the hot standby redundancy application, please contact service personnel.

In normal condition, it is the UPS 2 inverter that supplies power to the critical loads. Both UPS 1 & UPS 2 tri-color LEDs illuminate green.

When the UPS 2 inverter becomes abnormal, the UPS 2 will automatically transfer to bypass mode and the UPS 1 inverter will supply power to the critical loads. Under such circumstances, the UPS 1 tri-color LED illuminates green and the UPS 2 tri-color LED illuminates yellow.

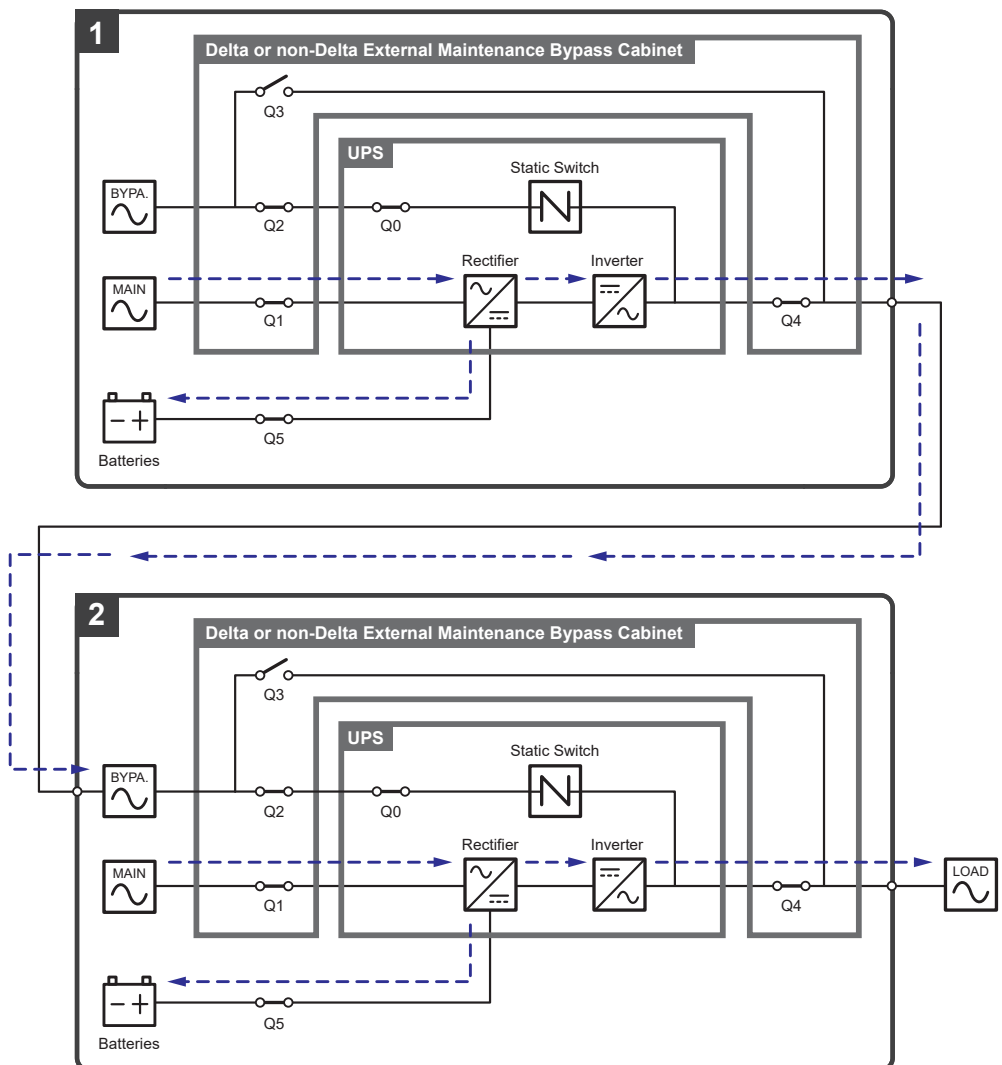

(Figure 3-32: Hot Standby Redundancy Diagram (only for Dual Input & at Least Two UPSs))

3.4 Common Battery (Only for Parallel UPSs connecting to the Same External Battery Cabinet(s))

To save on your costs and installation space, the parallel UPSs can share their connected external battery cabinet(s). For common battery application, please install an isolated switch between each parallel UPS and its connected external battery cabinet(s). Please see **Figure 3-33** for two parallel UPSs sharing one external battery cabinet as an example.

If the parallel UPSs share the external battery cabinet(s), you should use the LCD to set up relevant parameters such as **'Battery Type'**, **'Capacity'**, **'Battery Strings'**, **'Float Charge Voltage'**, **'Equalized Charge Voltage'**, **'Charge Current (Max)'**, etc. For more information, please refer to **7.10.4 Battery & Charging Setting**.



NOTE:

For common battery application, please use the LCD to set each UPS's float charge voltage (default: 272V) the same, each UPS's equalized charge voltage (default: 280V) the same, and each UPS's charge current even.

For example:

- A. When (1) two UPSs are paralleled, (2) they share one external battery cabinet, (3) the battery type is 200AH, (4) there are a total of 4 battery strings, and (5) the charge current is 80A, please use the LCD to set each UPS's **'Battery Type'** the same, **'Capacity'** as 200AH, **'Battery Strings'** as 2, and **'Charge Current (Max)'** as 40A.
- B. When (1) three UPSs are paralleled, (2) they share one external battery cabinet, (3) the battery type is 300AH, (4) there are a total of 3 battery strings, and (5) the charge current is 90A, please use the LCD to set each UPS's **'Battery Type'** the same, **'Capacity'** as 300AH, **'Battery Strings'** as 1, and **'Charge Current (Max)'** as 30A.

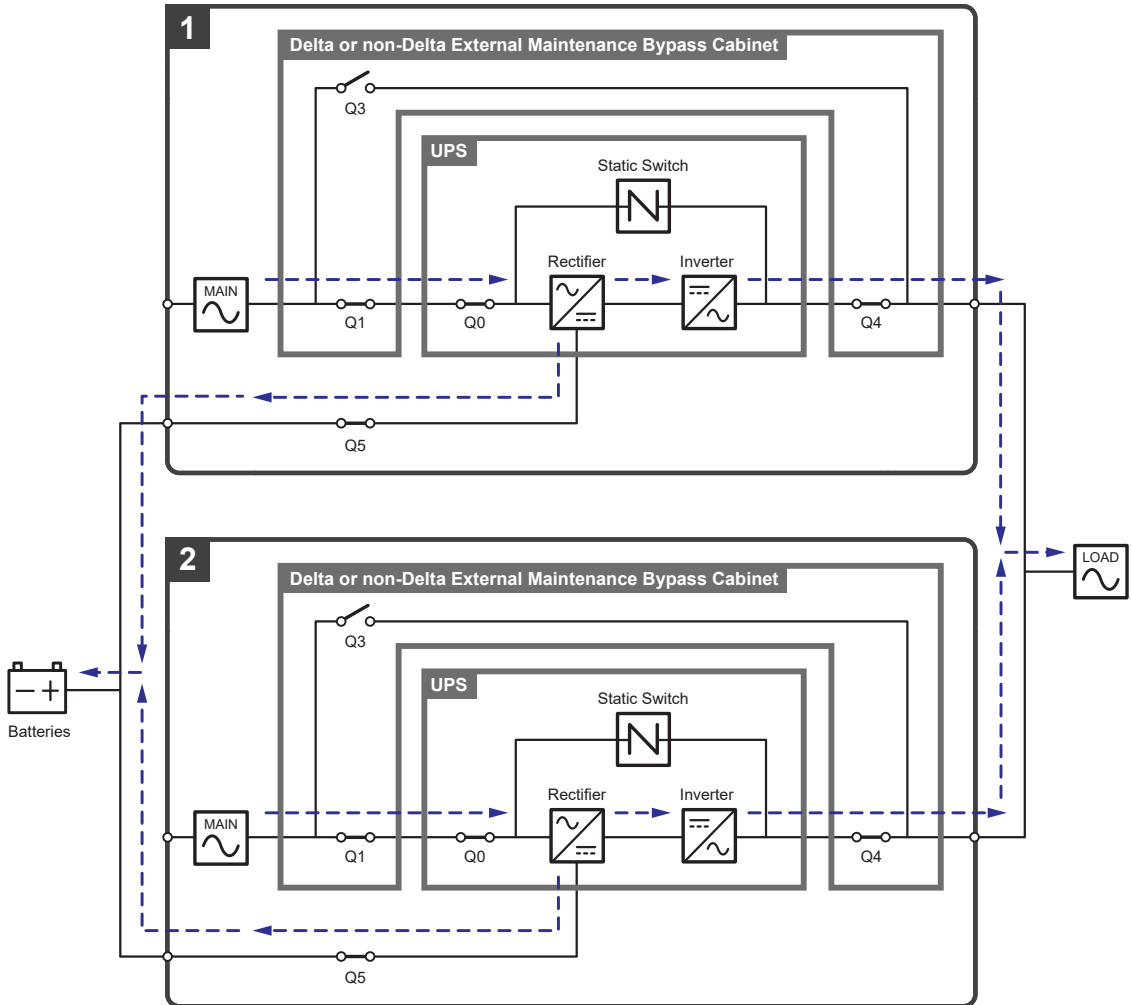

(Figure 3-33: Common Battery Diagram_ only for Parallel UPSs Connecting to the Same External Battery Cabinet(s))

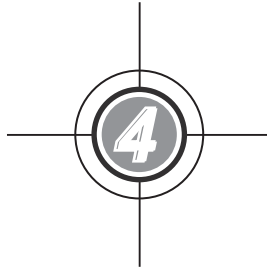

Communication Interfaces

- 4.1 Communication Interfaces on the Front of the UPS with Front Door Open
- 4.2 Communication Interfaces at the Rear of the Touch Panel

The communication interfaces are hot swappable and located at two different places. One is on the front of the UPS with front door open and the other is at the rear of the touch panel. Please see **Figure 4-1**.

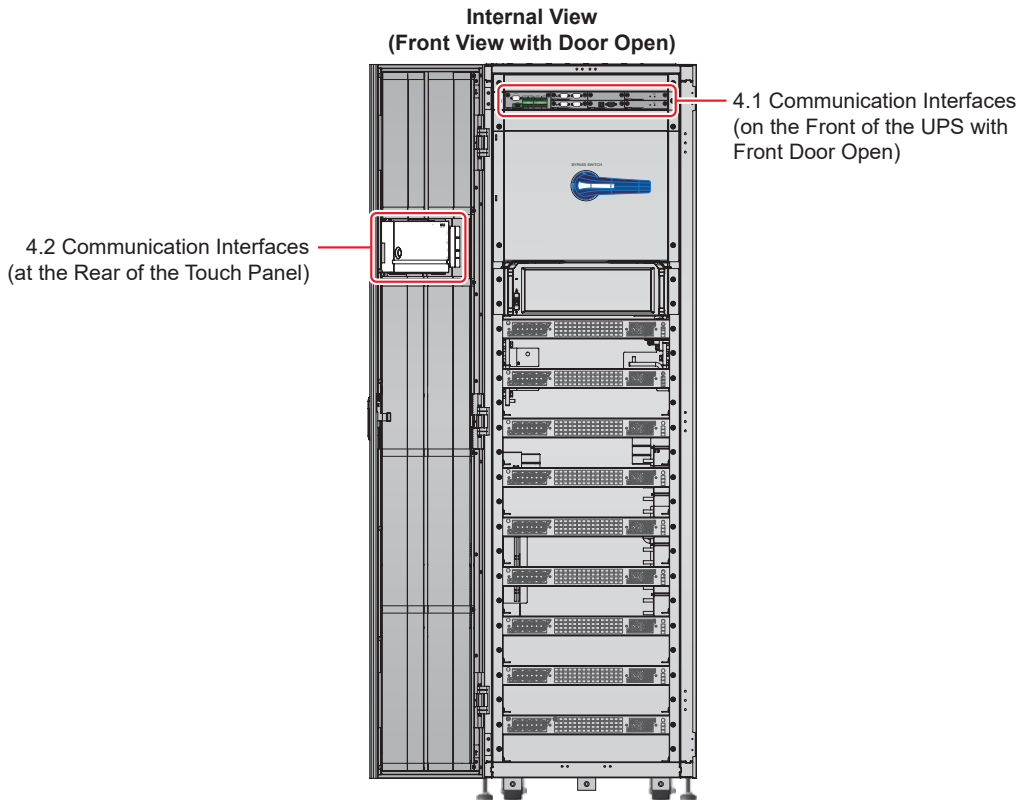

(Figure 4-1: Communication Interfaces Location)

4.1 Communication Interfaces on the Front of the UPS with Front Door Open

The following communication interfaces are located on the front of the UPS with front door open. Please see the description below.

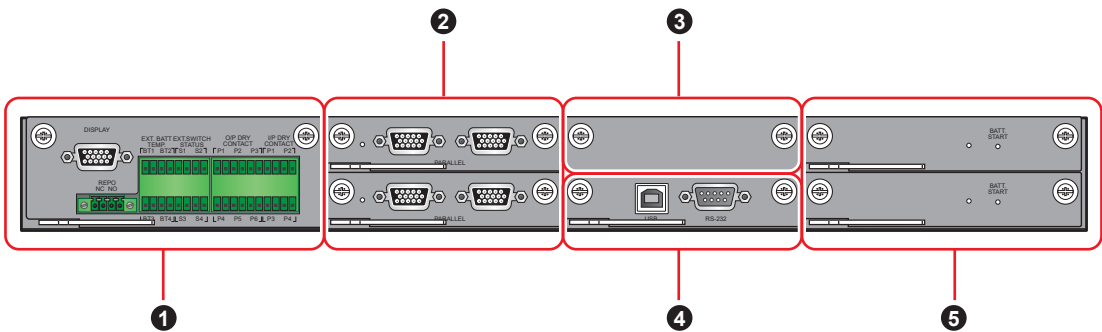

(Figure 4-2: Communication Interfaces_ on the Front of the UPS with Front Door Open)

No.	Item	Q'ty	Description
①	Dry Contact Card	1 PC	Includes a display port, REPO dry contacts, external battery temperature dry contacts, external switch/ breaker status dry contacts, output dry contacts and input dry contacts.
②	Parallel Communication Card	2 PCS	Each card includes two parallel ports and one LED indicator.
③	SMART Slot	1 PC	You can install the optional Relay I/O card for dry contact expansion.
④	System Control Card	1 PC	Includes a USB port and an RS-232 port.
⑤	Auxiliary Power Card	2 PCS	Each card includes a LED indicator and a battery start button.

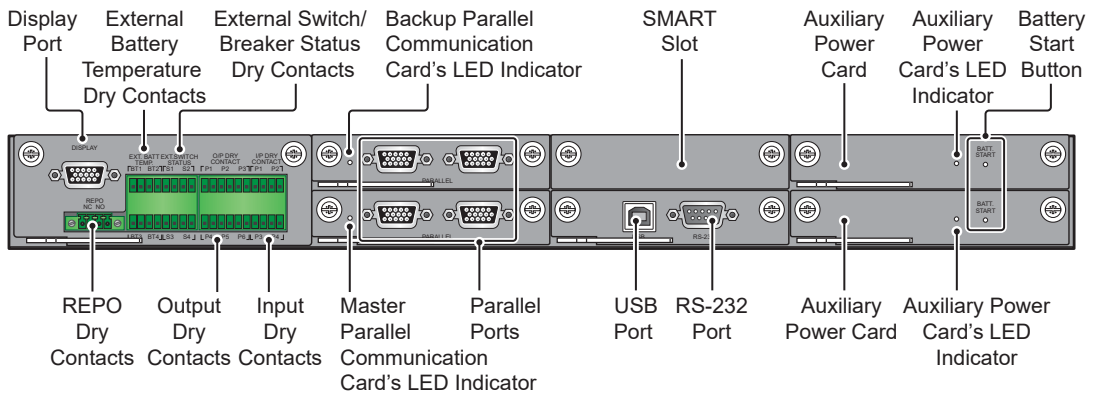

(Figure 4-3: Communication Interfaces Functions)

4.1.1 Display Port

Before shipment, the display port has been connected to the 10" touch panel with the designated cable in Delta factory.

4.1.2 REPO Dry Contacts

The REPO dry contacts provide you with quick and convenient interfaces to shut down the UPS safely when an emergency occurs. Connect the REPO dry contacts to a user-supplied switch and you can remotely shut down the UPS. The REPO dry contacts provide normally open (NO) and normally closed (NC) these two options for use.

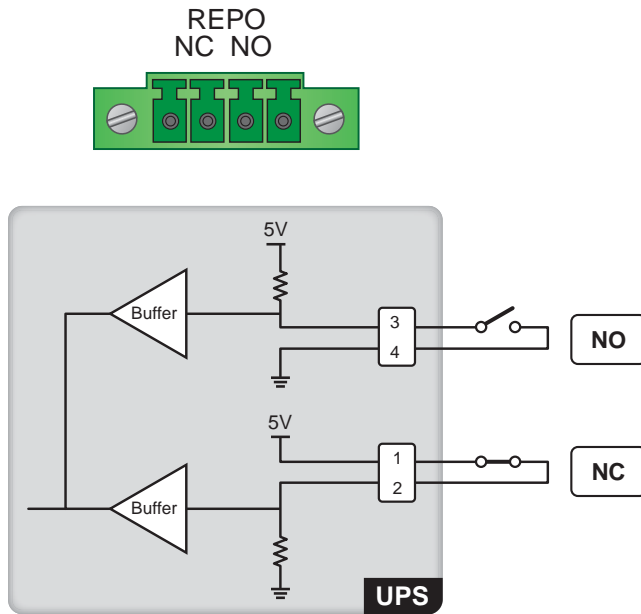

(Figure 4-4: REPO Dry Contacts Design)



NOTE: If you want to enable the normally closed (NC) function, please take out the dry contact card (see **Figure 4-5**) and remove its Jump CNR3 (see **Figure 4-6**) before you turn on the UPS.

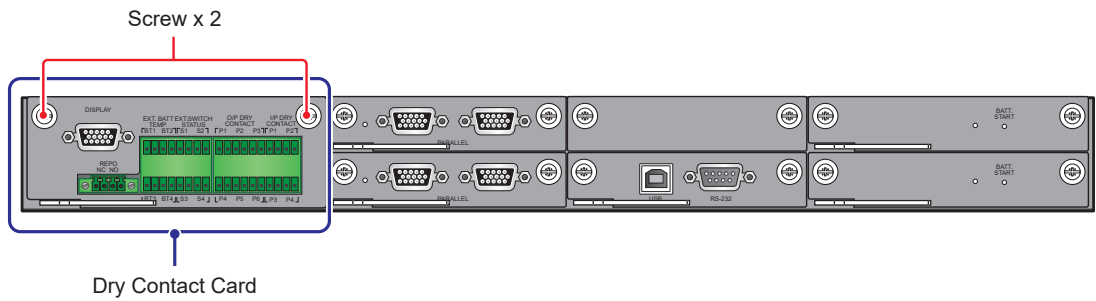

(Figure 4-5: Dry Contact Card Location)

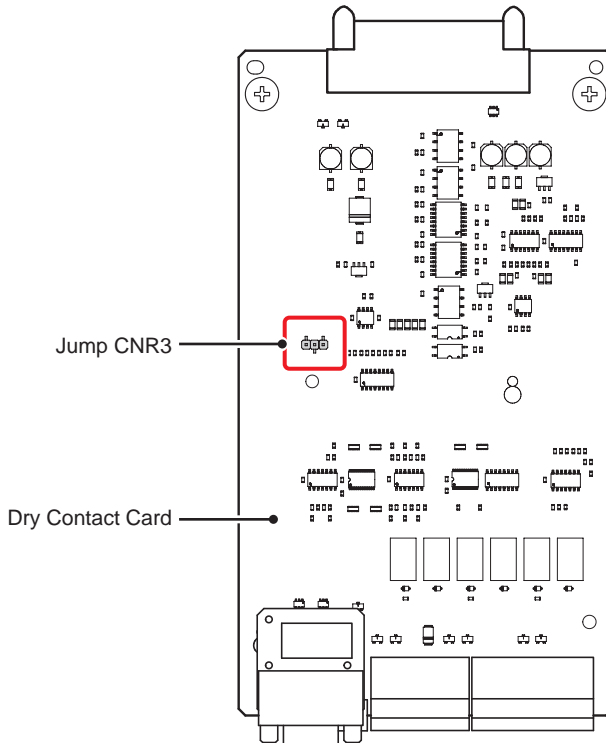

(Figure 4-6: Jump CNR3 Location)

4.1.3 External Battery Temperature Dry Contacts

You can use the external battery temperature dry contacts (BT1, BT2, BT3 and BT4) to detect at maximum four external battery cabinets' temperature. You need to purchase the battery cabinet temperature sensor cable (optional).

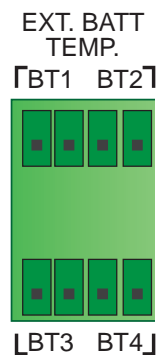

(Figure 4-7: External Battery Temperature Dry Contacts Design)

4.1.4 External Switch/ Breaker Status Dry Contacts

There are four sets of external switch/ breaker status dry contacts (S1, S2, S3 and S4), which can be used to detect the status of input, bypass, manual bypass and output switches or breakers. Please follow the table below to connect the dry contacts to normally open (NO) or normally closed (NC) devices.

Type	Connection
Dry Contact_ S1	Normally closed (NC) device
Dry Contact_ S2	Normally closed (NC) device
Dry Contact_ S3	Normally closed (NC) device
Dry Contact_ S4	Normally open (NO) device

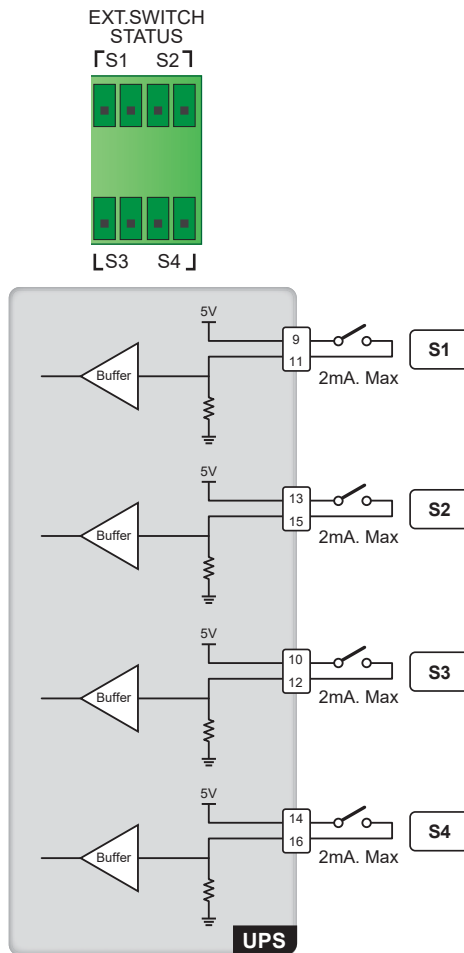

(Figure 4-8: External Switch/ Breaker Status Dry Contacts Design)

No.	Event	Description
1	External input switch or breaker detection.	Detect the external input switch or breaker's status (default: S1).
2	External bypass switch or breaker detection.	Detect the external bypass switch or breaker's status (default: S2).
3	External output switch or breaker detection.	Detect the external output switch or breaker's status (default: S3).
4	External manual bypass switch or breaker detection.	Detect the external manual bypass switch or breaker's status (default: S4).

4.1.5 Output Dry Contacts

There are six sets of programmable output dry contacts (see **Figure 4-9**). Please use the touch panel to set each dry contact as normally open (NO) or normally closed (NC). Each dry contact can be assigned with a specific event. Six out of twenty-one events can be assigned according to your applications. To learn how to set up, please contact your local dealer and refer to **7.10.6 Dry Contact Setting**. For the twenty-one events, please refer to the table below.



NOTE: Since the output dry contacts belong to the secondary circuit, the voltage of each dry contact's connected device should not exceed 60Vdc/ Vac to avoid electric shock and insufficient insulation.

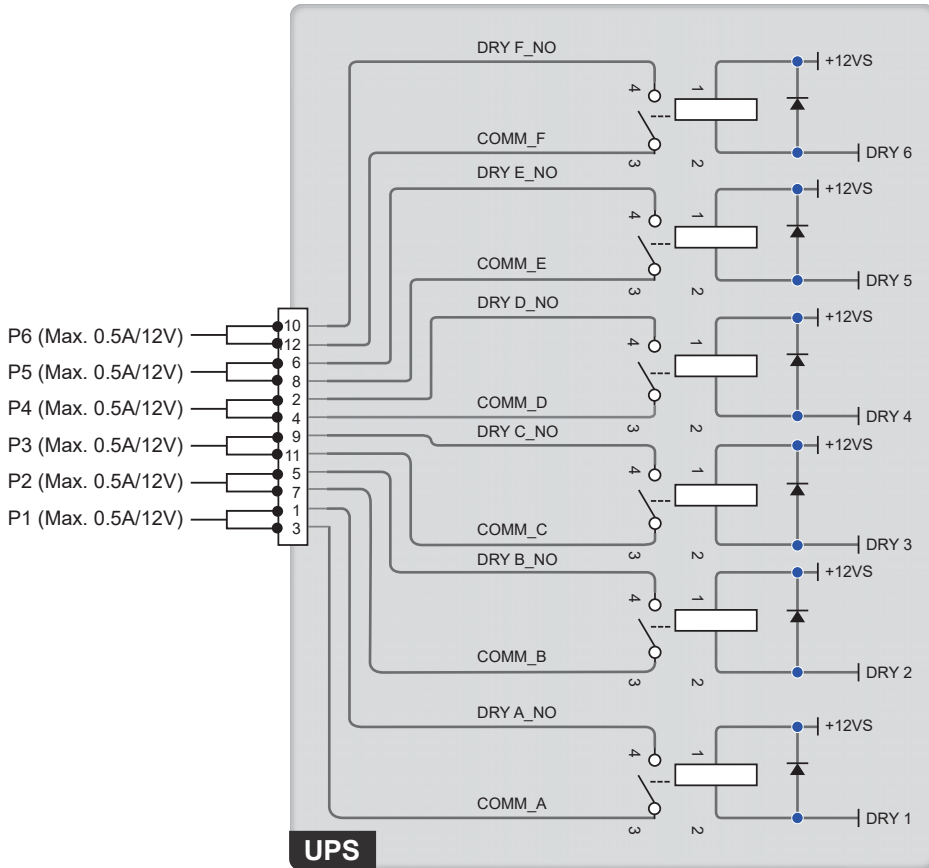
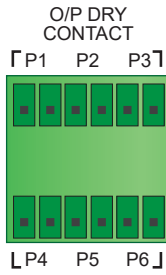

(Figure 4-9: Output Dry Contacts Design)

No.	Event	Description
1	None	No set-up.
2	Load On Inverter	The UPS works in online mode.
3	Load On Bypass	The UPS works in bypass mode.
4	Load On Battery	When the main AC source fails, the batteries supply power to the critical loads.
5	Battery Low	When the UPS runs in battery mode, battery voltage is lower than the setup limit (default: 220Vdc).
6	Bypass Input Abnormal	The bypass voltage, frequency or phase sequence is abnormal.
7	Battery Test Fail	During the battery test, the battery voltage is out of the setup limit.
8	Internal Comm. Fail	The #n power module's internal communication is abnormal.
9	External Parallel Comm. Fail	In parallel mode, parallel communication is abnormal.
10	Output Overload	The UPS is overloaded or the UPS shuts down to let the bypass supply power to the critical loads.
11	EPO Activated	The EPO button is pressed to urgently power off the UPS.
12	Load On Manual Bypass	The Manual Bypass Breaker or Switch (Q3) is turned on and the UPS transfers to manual bypass mode.
13	Battery Over Temperature	The external battery cabinet's temperature is too high.
14	Output Voltage Abnormal	The output voltage is too high or too low.
15	Battery Need Replacement	The battery replacement date is due.
16	Bypass Over Temperature	The bypass static switch temperature is too high.
17	Bypass Static Switch Fault	The bypass static switch has an open/ short issue.
18	UPS Over Temperature	The UPS temperature is too high.
19	Battery Breaker Shunt Trip	When the EPO button is pressed or low battery shutdown occurs, the UPS will send a signal to the connected external shunt trip device to cut off the battery power.
20	Backfeed Protection	When the UPS's bypass SCR has an open/ short issue, the UPS will send a signal to the connected external shunt trip device to cut off the backfeed voltage.
21	General Alarm	When any UPS alarm occurs, the UPS will send an I/O signal.

4.1.6 Input Dry Contacts

There are four sets of programmable input dry contacts (see **Figure 4-10**). Please use the touch panel to set each dry contact as normally open (NO) or normally closed (NC). The input dry contacts allow the UPS to receive external signals from peripheral devices and let the UPS response accordingly. Each input dry contact can be assigned with a specific event. There are four events can be assigned according to your applications. To learn how to set up, please contact your local dealer and refer to **7.10.6 Dry Contact Setting**. For information about the four events, please refer to the table below.

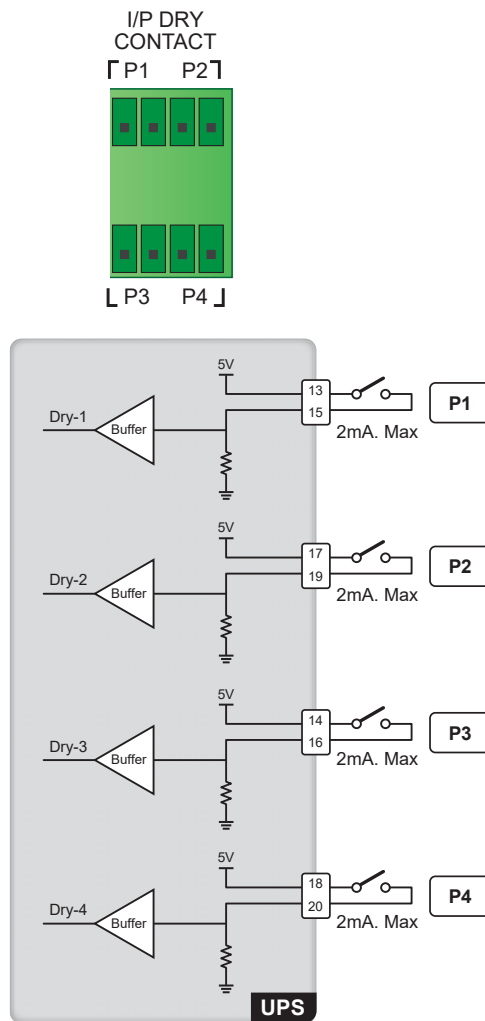

(Figure 4-10: Input Dry Contacts Design)

No.	Event	Description
1	None	No set-up.
2	Generator Status	Generator status detection.
3	Battery Ground Fail	Battery leakage detection.
4	External Battery Breaker Detection	Status detection of the external battery cabinet's breaker or switch.

4.1.7 Parallel Communication Cards

The UPS has two parallel communication cards, which are master parallel communication card and backup parallel communication card. Each card has one LED indicator. Please see **Figure 4-11** for their location.

If both cards work normally, the master parallel communication card's LED indicator will illuminate green and the backup parallel communication card's LED indicator will illuminate yellow.

If one card works normally and the other works abnormally, the normal card's LED indicator will illuminate green and the abnormal card's LED indicator will illuminate red.

During initialization process, both cards' LED indicators flash yellow.

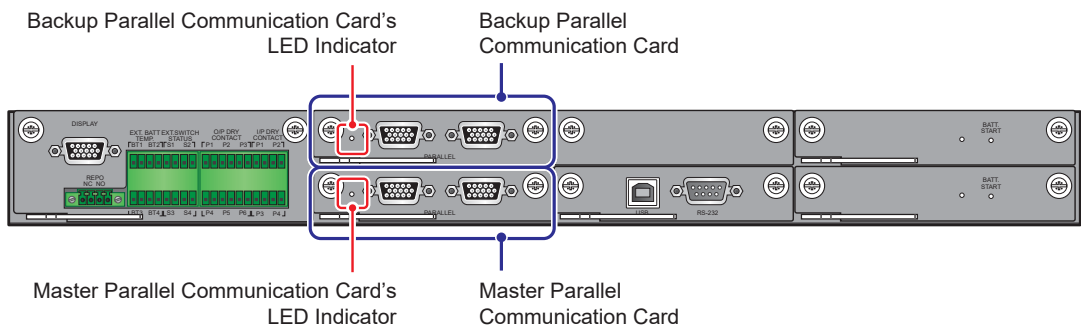

(Figure 4-11: Location of Parallel Communication Cards and Their LED Indicators)

4.1.8 Parallel Ports

The parallel ports are used to connect parallel UPSs to increase the system capacity and redundancy. With the provided parallel cable, up to eight UPS units with the same capacity, voltage and frequency can be paralleled. To enhance parallel reliability, please adopt Daisy Chain method (see **Figure 5-41** & **Figure 5-43**) to execute parallel configuration.



WARNING:

The provided parallel cable is placed in the accessory package. Using other types of cables to connect the parallel UPSs may cause parallel failure, malfunctions and accidents.

4.1.9 SMART Slot

You can install the optional Relay I/O card (for dry contact expansion) into the SMART slot shown in **Figure 4-12**. For relevant installation and application information, please contact Delta customer service.

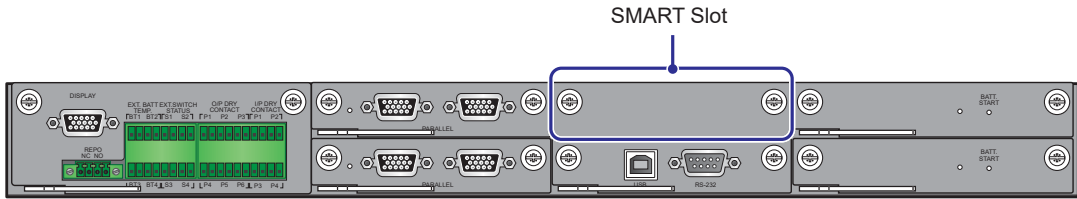

(Figure 4-12: SMART Slot Location)

4.1.10 USB Port & RS-232 Port

You can use the provided RS-232 cable or the USB cable to connect the UPS's RS-232 port or USB port with a computer, and use either the USB port or the RS-232 port to upgrade the firmware of UPS, power modules, system control card and parallel communication cards and download event logs.



NOTE: Do not use the RS-232 port and the USB port at the same time.

4.1.11 Auxiliary Power Cards

The UPS has two auxiliary power cards. Each card has one LED indicator. Please see **Figure 4-13** for their location.

If the auxiliary power card works normally, its LED indicator will illuminate green. If the auxiliary power card is off or abnormal, its LED indicator will be off.

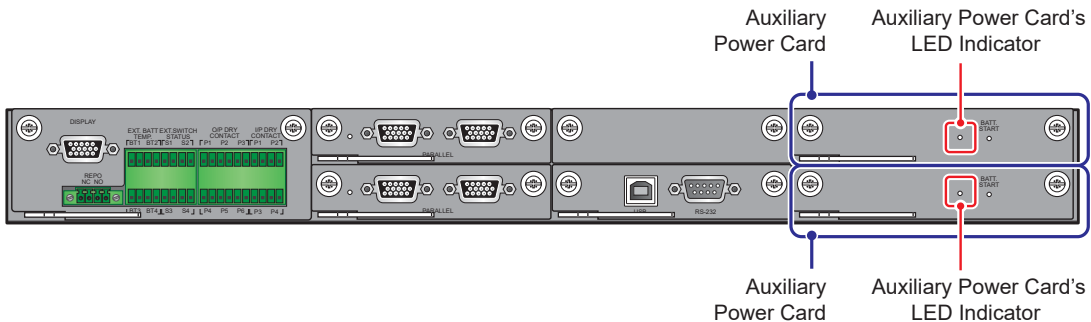

(Figure 4-13: Location of Auxiliary Power Cards and their LED Indicators)

4.1.12 Battery Start Buttons

Please refer to **6.2.2 Battery Mode Start-up Procedures** for relevant information.

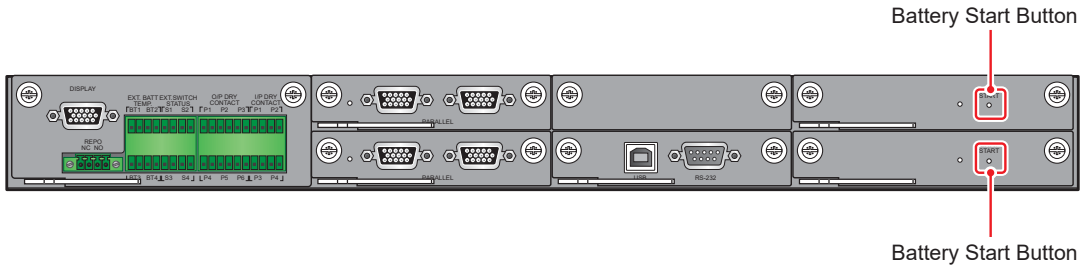



(Figure 4-14: Location of Battery Start Buttons)

4.2 Communication Interfaces at the Rear of the Touch Panel

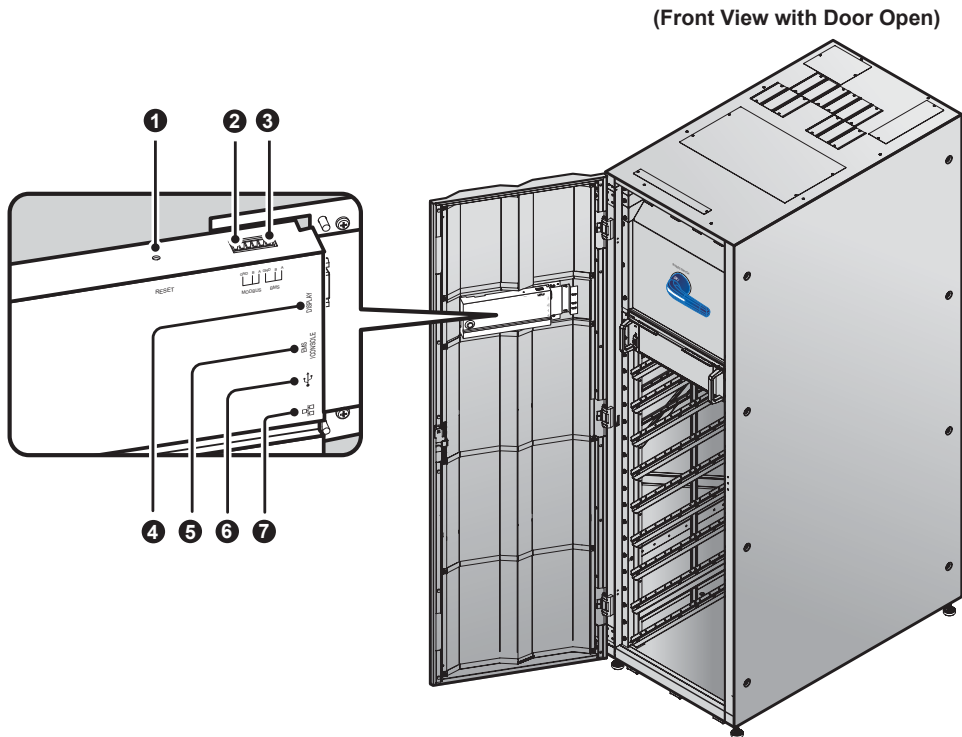
The following communication interfaces are located at the rear of the touch panel. Please see the description below.



(Figure 4-15: Communication Interfaces_ at the Rear of the Touch Panel)

No.	Item	Description
①	RESET	Press the RESET button once to restart the LCD.
②	MODBUS (Built-in MODUBS card)	<ol style="list-style-type: none"> 1. Lets the UPS have MODBUS communication function. 2. Connects to a user-supplied monitoring system.
③	BMS	Connects to a user-supplied battery management system or Delta battery management system (optional).
④	DISPLAY	<ol style="list-style-type: none"> 1. Connects to the display port shown in Figure 4-3. 2. Before shipment, the display port has been connected to the 10" touch panel with the designated cable in Delta factory.
⑤	EMS/ CONSOLE	Connects to a user-supplied environmental monitoring system or Delta EnviroProbe 1000/ 1100/ 1200 (optional).
⑥	 (USB Ports)	There are two USB ports. Connect a user-supplied USB flash drive to any of the USB ports to (1) upgrade the UPS and LCD's firmware and (2) download event logs.
⑦	 (Built-in SNMP card)	<ol style="list-style-type: none"> 1. Lets the UPS have network communication function. 2. Connects to a user-supplied monitoring system.

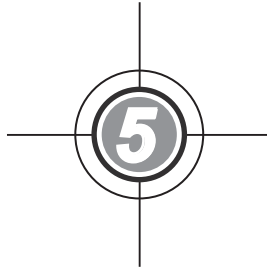

Installation and Wiring

- 5.1 Before Installation and Wiring
- 5.2 Installation Environment
- 5.3 UPS Transportation
- 5.4 Fixing the UPS
- 5.5 Wiring
- 5.6 External Battery Cabinet Connection Warnings
- 5.7 STS Module
- 5.8 Power Module (Optional)

5.1 Before Installation and Wiring

1. Please read this user manual thoroughly before installation, wiring and usage. Only authorized Delta engineers or service personnel can perform installation, wiring, panel & cover removal, maintenance and operation. If you want to execute any action mentioned above by yourself, the action must be under the supervision of authorized Delta engineers or service personnel. If you use a forklift or other equipment to move the UPS, please make sure its load bearing is sufficient. Please refer to **Table 5-1**.
2. The UPS must be connected with an external battery cabinet (user-supplied, handled and configured by Delta service personnel). Please refer to **5.6 External Battery Cabinet Connection Warnings** for relevant information.
3. The UPS must be connected with a Delta or non-Delta external maintenance bypass cabinet. The Delta external maintenance bypass cabinet is optional, and the non-Delta external maintenance bypass cabinet is user-supplied and should be handled and configured by Delta service personnel. For the Delta or non-Delta external maintenance bypass cabinet's information, please refer to the table below.

Delta External Maintenance Bypass Cabinet (Optional)	There are two models for selection. Please refer to the table below.		
	Delta External Maintenance Bypass Cabinet (Optional)		
	Model	3915101965-S 3915101964-S	
	Switch Q'ty	<table border="1" style="width: 100%; border-collapse: collapse;"> <tr> <td style="width: 50%; text-align: center;">3 Switches (Input Switch/ Manual Bypass Switch/ Output Switch)</td> <td style="width: 50%; text-align: center;">4 Switches (Input Switch/ Bypass Switch/ Manual Bypass Switch/ Output Switch)</td> </tr> </table>	3 Switches (Input Switch/ Manual Bypass Switch/ Output Switch)
3 Switches (Input Switch/ Manual Bypass Switch/ Output Switch)	4 Switches (Input Switch/ Bypass Switch/ Manual Bypass Switch/ Output Switch)		
Wiring Type	Top & Bottom Wiring Top & Bottom Wiring		
 NOTE: For more information about the Delta external maintenance bypass cabinet (optional), please refer to its user manual.			
Non-Delta External Maintenance Bypass Cabinet (User-supplied, handled and configured by Delta service personnel)	<p>For configurations of the non-Delta external maintenance bypass cabinet, please refer to the following.</p> <ol style="list-style-type: none"> a. Selection of three or four breakers (switches): <ol style="list-style-type: none"> (1) Three breakers (switches): An input breaker (switch), a manual bypass breaker (switch) and an output breaker (switch) should be installed. (2) Four breakers (switches): An input breaker (switch), a bypass breaker (switch), a manual bypass breaker (switch) and an output breaker (switch) should be installed. b. Each breaker (switch) mentioned above must be a 3-pole (R/ S/ T) device and meets the specifications defined in Table 5-3. c. It is suggested that each breaker (switch) should be configured with an auxiliary contactor. For relevant information, please refer to 4.1.4 External Switch/ Breaker Status Dry Contacts. d. Install the non-Delta external maintenance bypass cabinet next to the UPS or align it with the UPS for convenient operation. 		



NOTE: If there are switches but not breakers installed in the external maintenance bypass cabinet, please install (1) an additional protective device between the input power and the external maintenance bypass cabinet and (2) an additional protective device between the connected critical loads and the external maintenance bypass cabinet. The protective device could be a breaker or a fuse. For the protective device's rating current, please refer to the table below.

200kVA	300kVA	400kVA	500kVA
400A	600A	800A	1000A

4. In this user manual, the meaning of Q0, Q1, Q2, Q3, Q4 and Q5 represents the following.

Code	Meaning
Q0	UPS's Bypass Switch
Q1	Delta or non-Delta External Maintenance Bypass Cabinet's Input Breaker or Switch
Q2	Delta or non-Delta External Maintenance Bypass Cabinet's Bypass Breaker or Switch
Q3	Delta or non-Delta External Maintenance Bypass Cabinet's Manual Bypass Breaker or Switch
Q4	Delta or non-Delta External Maintenance Bypass Cabinet's Output Breaker or Switch
Q5	External Battery Cabinet's Breaker

5.2 Installation Environment

- Install the UPS indoors. Do not place it outdoors.
- Make sure that transportation routes (e.g. corridors, door gates, elevators, etc.) and installation area can accommodate and bear the weight of the UPS, external battery cabinet, Delta or non-Delta external maintenance bypass cabinet (refer to **5.1 Before Installation and Wiring** for relevant information) and handling equipment. Please refer to **Table 5-1** for floor weight loading information.

Table 5-1: UPS Floor Weight Loading Table

DPH Series UPS_ 200~500kVA				
UPS Weight: 317 kg (without power modules)				
UPS Weight Loading: 480.3 kg/m ² (without power modules)				
UPS Capacity	200kVA/ 200kW	300kVA/ 300kW	400kVA/ 400kW	500kVA/ 450kW
Power Module Q'ty	4	6	8	9
Weight	461 kg	533 kg	605 kg	641 kg
Weight Loading	698.5 kg/m ²	807.6 kg/m ²	916.7 kg/m ²	971.2 kg/m ²

- The UPS adopts top wiring. Please leave adequate space on the top of the UPS to allow cable entry. If you use the Delta external maintenance bypass cabinet (optional), top wiring and bottom wiring are both applicable.
- Ensure that the installation area is big enough for maintenance and ventilation. Since the UPS adopts the design of air inlet at the front and air outlet at the rear and external battery cabinets must be placed next to the UPS, we suggest that you:
 1. Keep a distance of 100cm from the front of the UPS for maintenance and ventilation.
 2. Keep a distance of at least 35cm from the back of the UPS for ventilation, or at least 50cm for maintenance.
 3. Keep a distance of 50cm from the top of the UPS for maintenance, wiring and ventilation.

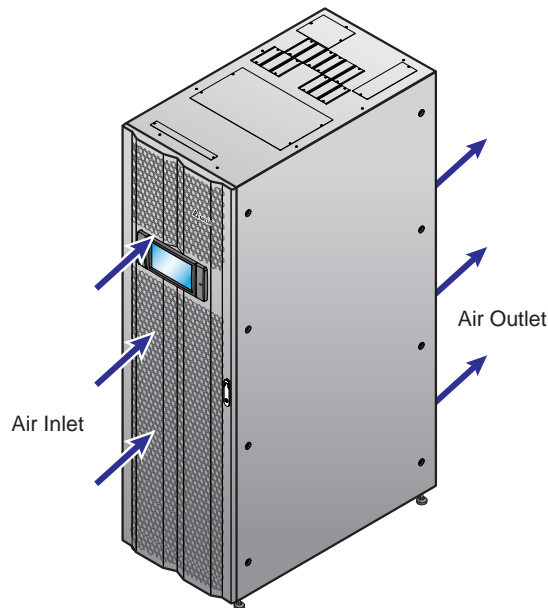

(Figure 5-1: UPS Air Inlet & Outlet Direction)

- Keep the installation area clean. Please note that wiring routes must be hermetic to prevent possible damage from rodents.
- Keep the installation area's temperature around 25°C and humidity below 95%. The highest operating altitude is 1000 meters above sea level.
- For safety concerns, we suggest that you:
 1. Equip surroundings of the installation area with CO₂ or dry powder fire extinguishers.
 2. Install the UPS in an environment where fireproof materials are used to construct the walls, floors and ceilings.
 3. Install the UPS on a floor that is made of noncombustible materials.

- Do not allow unauthorized personnel to enter the installation area and assign specified personnel to keep the UPS key.

**WARNING:**

Do not use air conditioners or similar equipment to blow into the rear of the UPS and hinder ventilation.

5.3 UPS Transportation

- At the bottom of the UPS, there are six casters to help you to move the UPS to a designated area. Before you move the UPS, please turn the four leveling feet counterclockwise to raise them off the ground. This protects the leveling feet from damage when moving the UPS. Please use sufficient manpower (at least six people) and equipment (e.g. forklift) to carefully move the UPS from its pallet to ground. Please pay attention to the movement of the casters to avoid accidents.

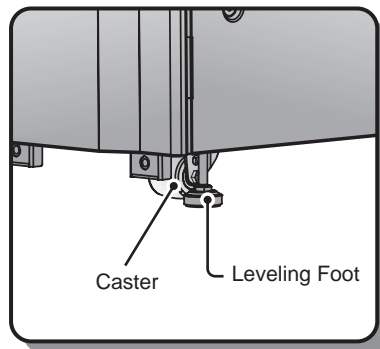

(Figure 5-2: UPS Leveling Foot and Caster)

**WARNING:**

1. The UPS is fixed on the pallet with two balance supports. When taking apart the two balance supports from the UPS, please pay attention to the movement of the casters to avoid accidents.
 2. Please refer to the **Unpacking Guide** attached to the UPS external wooden box for location of the balance supports.
- The casters are designed to move on level ground. Do not move the UPS on an uneven surface. This might cause damage to the casters or tip the UPS which could damage the unit.
 - After the UPS has been removed from the pallet to ground, we suggest that at least three people move the UPS to the installation area. One person use their hands to hold a lateral side of the UPS, one person hold the other lateral side of the UPS with their hands, and one person use their hands to push the UPS either from the front side or from the backside to move the unit to the installation area and avoid tipping the UPS.
 - If you need to move the UPS over a long distance, please use appropriate equipment like a forklift. Do not use the UPS casters to move the unit over a long distance.

5.4 Fixing the UPS

Please follow the steps below:

- 1 Before fixing the UPS in a designated installation area, please double check whether the area's floor weight loading is sufficient to bear the UPS, external battery cabinet, Delta or non-Delta external maintenance bypass cabinet and handling equipment (i.e. forklift) to avoid accidents. For UPS floor weight loading information, please refer to **Table 5-1**.
- 2 After the UPS is moved to the designated installation area, use a #17 wrench to stabilize the UPS four leveling feet on the floor. Please note that the UPS must stand on the floor stably and levelly without any tipping.
- 3 Use a 17mm socket wrench and three M10 screws ❶ (originally used to fix the front balance support on the pallet) to install the front balance support (removed during the unpacking process) at the front of the UPS. Use the three expansion screws ❷ (provided by qualified service personnel) to fix the front balance support on the ground to avoid UPS movement. Please see **Figure 5-3**.

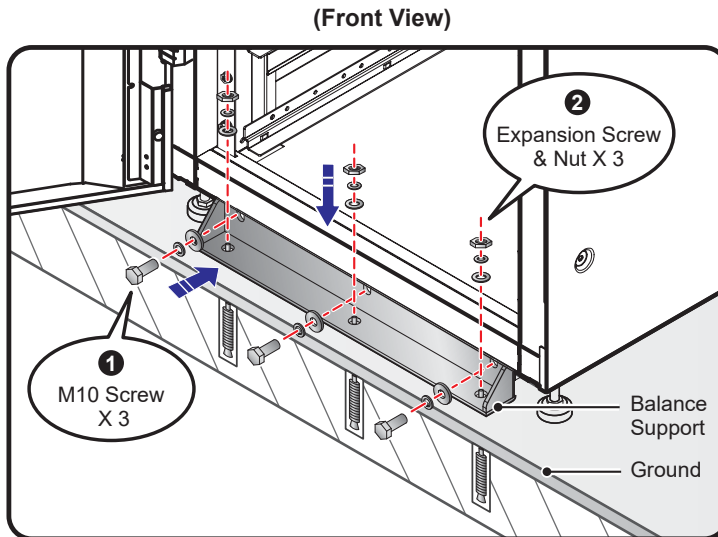

(Figure 5-3: Install the Balance Support at the Front of UPS)

- 4 Use a 17mm socket wrench and three M10 screws ❶ (originally used to fix the rear balance support on the pallet) to install the rear balance support (removed during the unpacking process) at the rear of the UPS. Use the three expansion screws ❷ (provided by qualified service personnel) to fix the rear balance support on the ground to avoid UPS movement. Please see **Figure 5-4**.

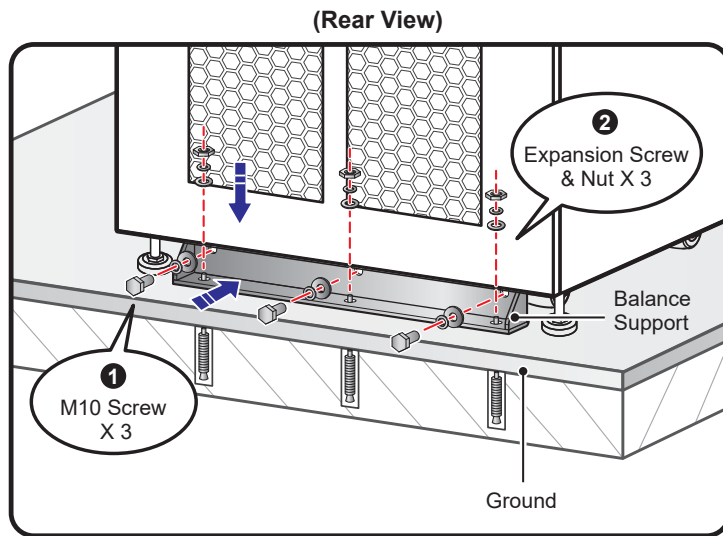

(Figure 5-4: Install the Balance Support at the Rear of UPS)



WARNING:

If you don't use the balance supports to fix the UPS on the ground, the unit might topple over. For safety concerns, please use the balance supports to fix the UPS to the floor.

- ⑤ Follow **5.5 Wiring** to perform wiring procedures.
- ⑥ Follow **5.6 External Battery Cabinet Connection Warnings** to connect the external battery cabinet(s).
- ⑦ Follow **5.8 Power Module (Optional)** to install the power modules.
- ⑧ After finishing the procedures above, close the UPS front door.

5.5 Wiring

5.5.1 Pre-wiring Warnings



NOTE:

1. Before wiring, please ensure that you have followed **5.4 Fixing the UPS** to fix the UPS in the designated installation area firmly.
2. Before wiring, please read **5.5 Wiring** thoroughly.
3. Only authorized Delta engineers or service personnel can perform installation, wiring, panel & cover removal, maintenance and operation. If you want to execute any action mentioned above by yourself, the action must be under the supervision of authorized Delta engineers or service personnel.
4. The UPS must be connected with a Delta or non-Delta external maintenance bypass cabinet. The Delta external maintenance bypass cabinet is optional, and the non-Delta external maintenance bypass cabinet is user-supplied and should be handled and configured by Delta service personnel. For the Delta or non-Delta external maintenance bypass cabinet's information, please refer to **1.2 Connection Warnings**.

- Before wiring or making any electrical connection, make sure that the power supplied to the input and output of the UPS is completely cut off.
- The UPS adopts top wiring. Please leave adequate space on the top of the UPS to allow cable entry. If you use the Delta external maintenance bypass cabinet (optional), top wiring and bottom wiring are both applicable.
- Check that the size, diameter, phase, polarity are correct for each cable that needs connecting to the UPS, external battery cabinet and external maintenance bypass cabinet. Please refer to **Table 5-2** for the specifications of input/ output/ battery cables, switches and breakers.



NOTE: **Table 5-2** is based on (1) default input/ output voltage: 220V, (2) default battery Q'ty: 40PCS and (3) default charge current per power module: 5A. For other conditions different from **Table 5-2**, please contact service personnel for relevant values.

Table 5-2: Specifications of Input/ Output/ Battery Cables, Switches and Breakers

DPH 200~500kVA					
Capacity		200kVA/ 200kW	300kVA/ 300kW	400kVA/ 400kW	500kVA/ 450kW
Power Module Q'ty		4	6	8	9
Input	Rated current at input voltage 220V (in the status of battery charging)	340A	510A	680A	765A

DPH 200~500kVA					
Capacity		200kVA/ 200kW	300kVA/ 300kW	400kVA/ 400kW	500kVA/ 450kW
Input	Recommended cable size (R/ S/ T/ N)	95mm ² x 2 PCS	150mm ² x 2 PCS	240mm ² x 2 PCS	185mm ² x 3 PCS
	Maximum cable size (R/ S/ T/ N)	300mm ² x 3 PCS	300mm ² x 3 PCS	300mm ² x 3 PCS	300mm ² x 3 PCS
	Cable lug width	50mm	50mm	50mm	50mm
	Screw size	M12	M12	M12	M12
Output	Rated current at output voltage 220V	303A	455A	606A	758A
	Recommended cable size (R/ S/ T/ N)	95mm ² x 2 PCS	150mm ² x 2 PCS	240mm ² x 2 PCS	185mm ² x 3 PCS
	Maximum cable size (R/ S/ T/ N)	300mm ² x 3 PCS	300mm ² x 3 PCS	300mm ² x 3 PCS	300mm ² x 3 PCS
	Cable lug width	50mm	50mm	50mm	50mm
	Screw size	M12	M12	M12	M12
Battery	Rated current (12V x 40 PCS batteries)	440A	660A	880A	990A
	Recommended cable size (+/ -/ N)	120mm ² x 2 PCS	240mm ² x 2 PCS	185mm ² x 3 PCS	240mm ² x 3 PCS
	Maximum cable size (+/ -/ N)	240mm ² x 4 PCS	240mm ² x 4 PCS	240mm ² x 4 PCS	240mm ² x 4 PCS
	Cable lug width	50mm	50mm	50mm	50mm
	Screw size	M12	M12	M12	M12
Tightening Torque		M12=500±20Kgf.cm			
UPS's Bypass Switch (Q0)		1000A			
Delta or non-Delta External Maintenance Bypass Cabinet's Input Breaker or Switch (Q1)		400A	600A	800A	1000A
Delta or non-Delta External Maintenance Bypass Cabinet's Bypass Breaker or Switch (Q2)		400A	600A	800A	1000A
Delta or non-Delta External Maintenance Bypass Cabinet's Manual Bypass Breaker or Switch (Q3)		400A	600A	800A	1000A
Delta or non-Delta External Maintenance Bypass Cabinet's Output Breaker or Switch (Q4)		400A	600A	800A	1000A
External Battery Cabinet's Breaker (Q5)		500A	800A	1000A	1200A

**NOTE:**

1. In accordance with National Electrical Codes (NEC), please install a suitable conduit and bushing for cable protection.
 2. Please refer to national and local electrical codes for acceptable non-fuse switches, breakers and cable size.
 3. The cables mentioned in **Table 5-2** with PVC material and with temperature resistance up to 105°C are suggested.
 4. The tightening torque for M12 screw should be 500±20Kgf.cm.
- To avoid UPS failure, the input of the UPS must be a Y connection.
 - If there is a floating voltage between the input power's neutral (N) and the ground (⊕), and you require that the VNG of the UPS should be zero, we suggest that you install an isolation transformer in front of the input side of the UPS, and connect the isolation transformer's secondary neutral (N) and the ground (⊕) to the nearest place of the transformer.
 - The main AC source must be a three-phase four-wire system and meets the specifications specified on the UPS rating label. For main AC source connection, make sure it is in positive phase sequence. Please refer to **5.5.3 Single Unit Wiring** and **5.5.4 Parallel Units Wiring** for wiring information.
 - For external battery cabinet connection, please check the battery polarity. Do not connect the batteries in reverse. Please refer to **5.6 External Battery Cabinet Connection Warnings**.
 - Connect the external battery cabinet's grounding terminal (⊕) to the Delta or non-Delta external maintenance bypass cabinet's grounding terminal (⊕). Please refer to **Figure 5-16** and **Figure 5-19** for grounding information.
 - The UPS's grounding terminal (⊕) must be grounded. Please use ring-type terminals when wiring. For the location of the UPS's grounding terminal (⊕), please refer to **Figure 5-14**.

**WARNING:**

1. Wrong wiring will cause damage to the UPS and electric shock.
2. The UPS will not work normally if the main AC source's neutral (N) is not firmly connected or not connected to the Delta or non-Delta external maintenance bypass cabinet's AC Input neutral (N) terminal.
3. If the UPS is not grounded, the power boards and components might be damaged after the UPS is powered on.

5.5.2 Single Input/ Dual Input Modification

**WARNING:**

Only authorized Delta engineers or service personnel can modify single input/ dual input setup.

The UPS default setting is single input. If you want to modify it into dual input, please follow the procedures below.

- 1) Unscrew the eight M5 screws to remove the rear panel (see **Figure 5-5** and **Figure 5-6**). After removing the rear panel, you will see the AC Input terminals and Bypass Input terminals shown in **Figure 5-7**.

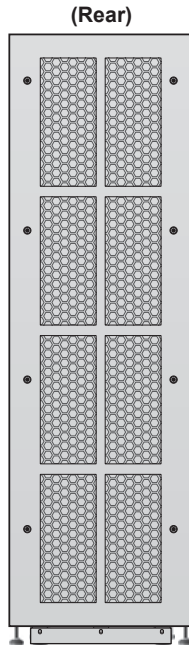

(Figure 5-5: UPS Rear View)

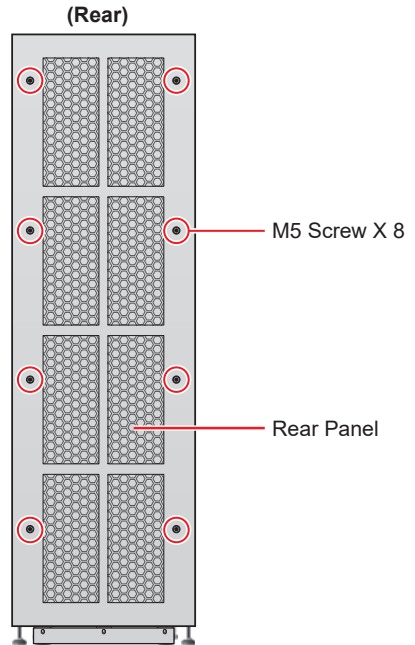

(Figure 5-6: Rear Panel & Screw Location)

(Rear View after Rear Panel Removal)

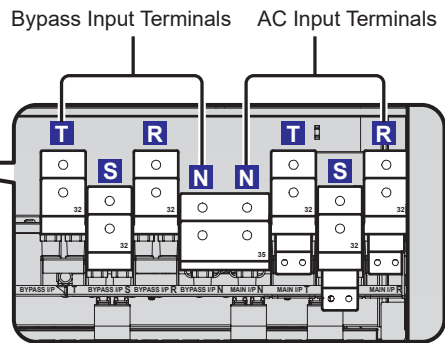
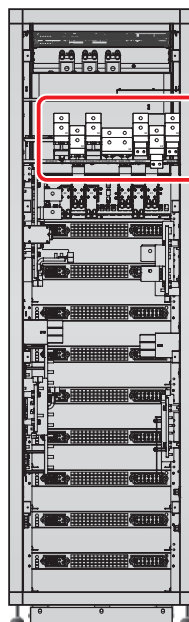

(Figure 5-7: Wiring Terminals_ AC Input & Bypass Input)

- 2) Unscrew the six screws and six nuts to remove the nine cables connected between the AC Input Terminals (R/ S/ T) and the Bypass Input terminals (R/ S/ T) in order to modify the UPS from single input into dual input. Please refer to **Figure 5-8**.

Rear View after Rear Panel Removal

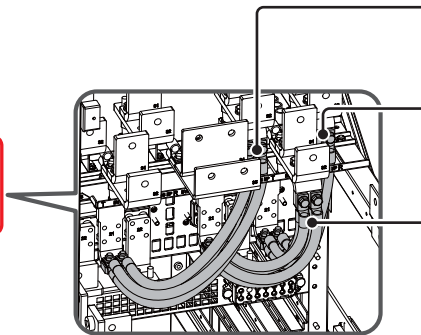
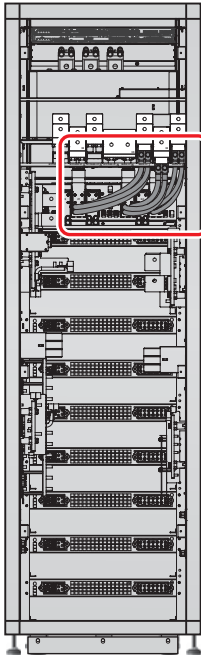

Remove the 3 Cables, 2 Screws and 2 Nuts that Connect the AC Input and Bypass Input's T Terminals

Remove the 3 Cables, 2 Screws and 2 Nuts that Connect the AC Input and Bypass Input's R Terminals

Remove the 3 Cables, 2 Screws and 2 Nuts that Connect the AC Input and Bypass Input's S Terminals

(Figure 5-8: Remove the Nine Cables that Connect the AC Input Terminals (R/ S/ T) and the Bypass Input Terminals (R/ S/ T))



NOTE:

1. Please keep the six screws, six nuts and the nine cables well for future use.
2. If you want to modify the UPS from dual input into single input, please use the removed six screws and six nuts to reinstall the removed nine cables.

5.5.3 Single Unit Wiring



NOTE:

1. Only authorized Delta engineers or service personnel can perform installation, wiring, panel & cover removal, maintenance and operation. If you want to execute any action mentioned above by yourself, the action must be under the supervision of authorized Delta engineers or service personnel.
2. The UPS rating voltage is 220/ 380Vac, 230/ 400Vac or 240/ 415Vac.
3. The external battery cabinet's rating voltage is ± 240 Vdc.
4. Before wiring, please read **5.5 Wiring** thoroughly.

- **Single Input (Single Unit)**

When there is only one AC power source, single unit wiring procedures are as follows.

- 1 The UPS adopts top wiring. Please leave adequate space on the top of the UPS to allow cable entry.



NOTE: If you use the Delta external maintenance bypass cabinet (optional), top wiring and bottom wiring are both applicable. For relevant information, please refer to ***Delta External Maintenance Bypass Cabinet User Manual***.

- 2 Remove the eleven covers on the top of the UPS for cable entry. Each top cover has two #6-32 screws. For the location of top covers, please refer to the white areas shown in ***Figure 5-9***.

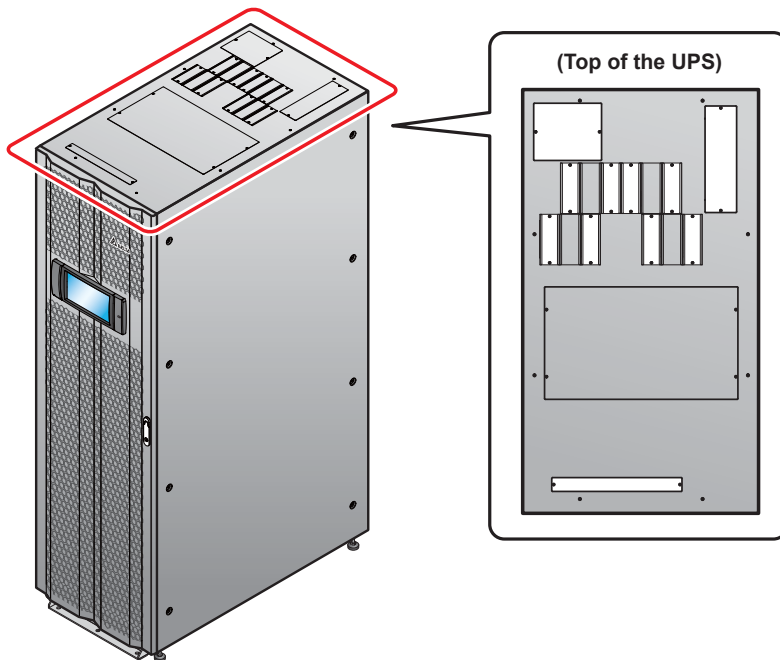

(Figure 5-9: Location of Top Covers)

- 3 Unscrew the eight M5 screws to remove the rear panel (see ***Figure 5-10*** and ***Figure 5-11***). After removing the rear panel, you will see the wiring terminals shown in ***Figure 5-12 ~ Figure 5-14***.

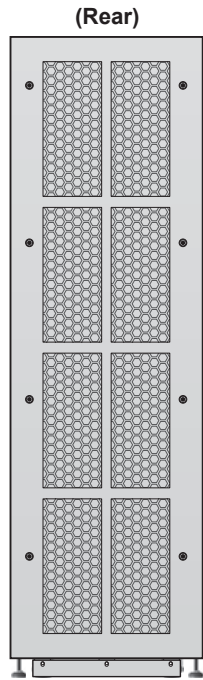

(Figure 5-10: UPS Rear View)

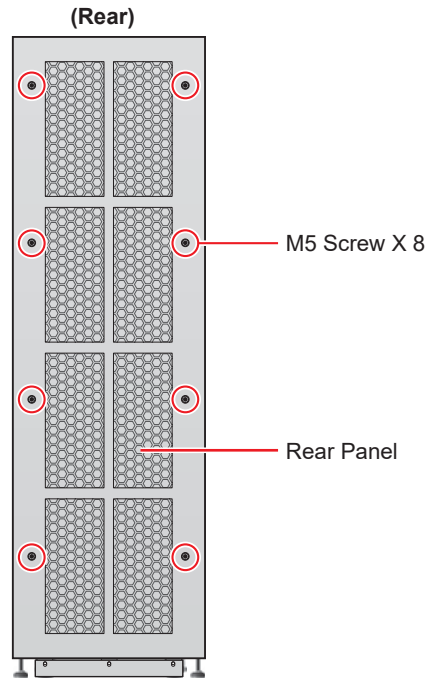

(Figure 5-11: Rear Panel & Screw Location)

(Rear View after Rear Panel Removal)

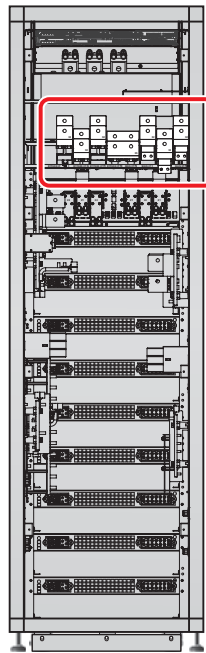

Bypass Input Terminals AC Input Terminals

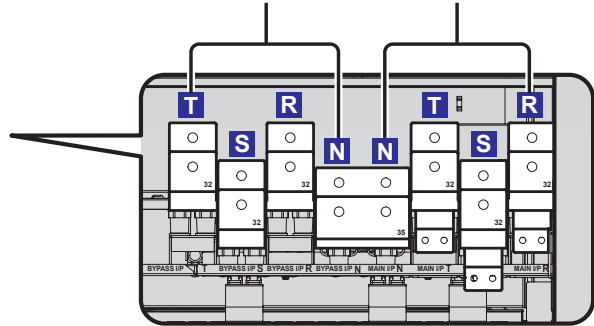

(Figure 5-12: Wiring Terminals_ AC Input & Bypass Input)

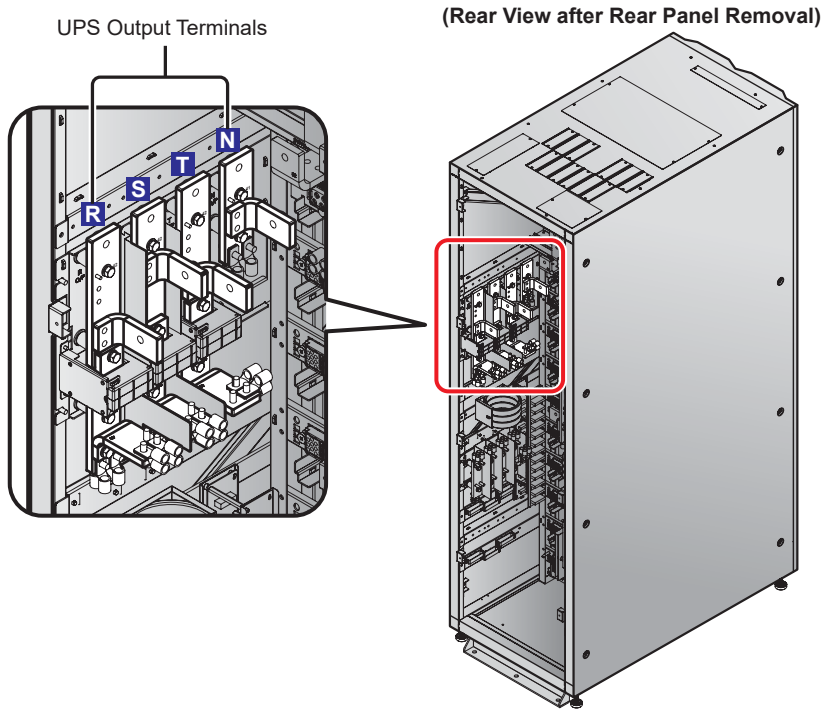

(Figure 5-13: Wiring Terminals_ UPS Output)

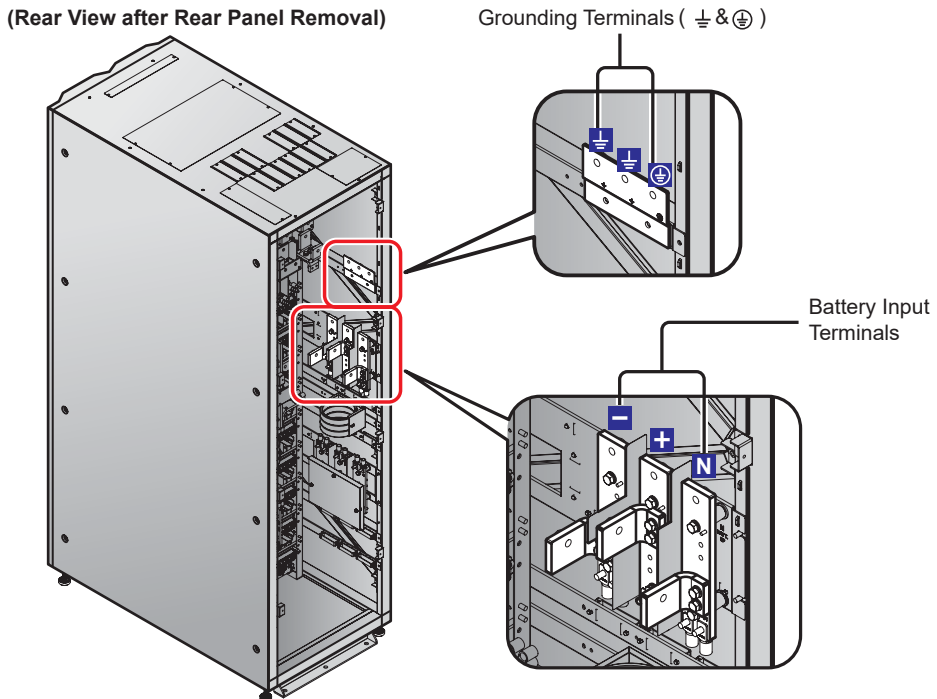

(Figure 5-14: Wiring Terminals_ Battery Input & Grounding)

- 4 For how to perform wiring between the UPS and the Delta or non-Delta external maintenance bypass cabinet, please refer to **Table 5-3**. For the detailed information about the Delta or non-Delta external maintenance bypass cabinet, please refer to **5.1 Before Installation and Wiring**.

Table 5-3: Wiring between the UPS and the Delta or non-Delta External Maintenance Bypass Cabinet





No.	Item*1	Description	Function
1	AC Input Terminals	Include R/ S/ T/ N terminals.	<ul style="list-style-type: none"> • Single Input: There is no need to connect these AC Input Terminals. • Dual Input: The terminals connect to the Delta or non-Delta external maintenance bypass cabinet's input breaker or switch (Q1).
2	Bypass Input Terminals	Include R/ S/ T/ N terminals.	<ul style="list-style-type: none"> • Single Input: The terminals connect to the Delta or non-Delta external maintenance bypass cabinet's input breaker or switch (Q1). • Dual Input: The terminals connect to the Delta or non-Delta external maintenance bypass cabinet's bypass breaker or switch (Q2).
3	UPS Output Terminals	Include R/ S/ T/ N terminals.	Connect to the Delta or non-Delta external maintenance bypass cabinet's output breaker or switch (Q4).
4	Battery Input Terminals	Include +/- N terminals.	<ul style="list-style-type: none"> • If you choose to use the Delta external maintenance bypass cabinet (optional), please connect these terminals to the Delta external maintenance bypass cabinet's Battery Input Terminals. • If you choose to use the non-Delta external maintenance bypass cabinet, please contact service personnel for battery configurations.
5		Includes one grounding terminal (for the UPS's protective earthing).	<ul style="list-style-type: none"> • Connects to the Delta or non-Delta external maintenance bypass cabinet's grounding terminal (\perp).



NOTE: *1 The items listed in the above 'Item' column are all located at the rear of the UPS. Please refer to **Figure 5-12 ~ Figure 5-14**.

- 5) For how to perform wiring for the Delta or non-Delta external maintenance bypass cabinet, please refer to **Table 5-4**. For the detailed information about the Delta or non-Delta external maintenance bypass cabinet, please refer to **5.1 Before Installation and Wiring**.

Table 5-4: Delta or non-Delta External Maintenance Bypass Cabinet Wiring Information

No.	Item*2	Description	Function
1	Input Breaker or Switch (Q1)	Includes R/ S/ T/ N terminals*3.	The breaker or switch (Q1) connects to the main AC source.
2	Bypass Breaker or Switch (Q2) (Only for dual input application)	Includes R/ S/ T/ N terminals*3.	The breaker or switch (Q2) connects to the bypass AC source.
3	Manual Bypass Breaker or Switch (Q3)	Includes R/ S/ T/ N terminals*3.	<ul style="list-style-type: none"> • Single Input: The breaker or switch (Q3) connects to the main AC source. • Dual Input: The breaker or switch (Q3) connects to the bypass AC source.
4	Output Breaker or Switch (Q4)	Includes R/ S/ T/ N terminals*3.	The breaker or switch (Q4) connects to the critical loads.
5	Battery Input Terminals	Include +/- N terminals.	<ul style="list-style-type: none"> • If you choose to use the Delta external maintenance bypass cabinet (optional), please connect these terminals to the external battery cabinet. • If you choose to use the non-Delta external maintenance bypass cabinet, please contact service personnel for battery configurations.
6		Includes one grounding terminal.	For the Delta or non-Delta external maintenance bypass cabinet's protective earthing.
7		Includes at least three grounding terminals.	<p>The three grounding terminals shall connect to</p> <ol style="list-style-type: none"> 1. the UPS's grounding terminal (), 2. the external battery cabinet's grounding terminal (), and 3. the connected critical loads' grounding terminal (). <p>Please refer to Figure 5-16 and Figure 5-19.</p>



NOTE:

1. *2 If you choose to use the non-Delta external maintenance bypass cabinet (user-supplied), all breakers, switches and terminals listed in the above **'Item'** column must be installed. For the configurations of the non-Delta external maintenance bypass cabinet, please refer to **5.1 Before Installation and Wiring**.
2. *3 If you choose to use the Delta external maintenance bypass cabinet (optional), please note that each switch only has R/ S/ T terminals. The N terminals are located on the cabinet's copper bars. For relevant information, please refer to **Delta External Maintenance Bypass Cabinet User Manual**.

- 6 Confirm that the UPS's Bypass Switch (Q0) is in the **OFF** position.
- 7 Confirm that the Delta or non-Delta external maintenance bypass cabinet's Input Breaker or Switch (Q1), Manual Bypass Breaker or Switch (Q3) and the Output Breaker or Switch (Q4) are in the **OFF** position.
- 8 Follow **Table 5-2** to select proper input, output and battery cables.
- 9 Connect the main AC source/ output/ external battery cabinet's cables to the UPS and the Delta or non-Delta external maintenance bypass cabinet. For wiring, please refer to the following.

Figure 3-1: Single Input Application_ UPS and Delta or non-Delta External Maintenance Bypass Cabinet Structure

Figure 5-12: Wiring Terminals_ AC Input & Bypass Input

Figure 5-13: Wiring Terminals_ UPS Output

Figure 5-14: Wiring Terminals_ Battery Input & Grounding

Table 5-3: Wiring between the UPS and the Delta or non-Delta External Maintenance Bypass Cabinet

Table 5-4: Delta or non-Delta External Maintenance Bypass Cabinet Wiring Information

Figure 5-15: Single Unit Single Input Wiring Diagram

5.6 External Battery Cabinet Connection Warnings

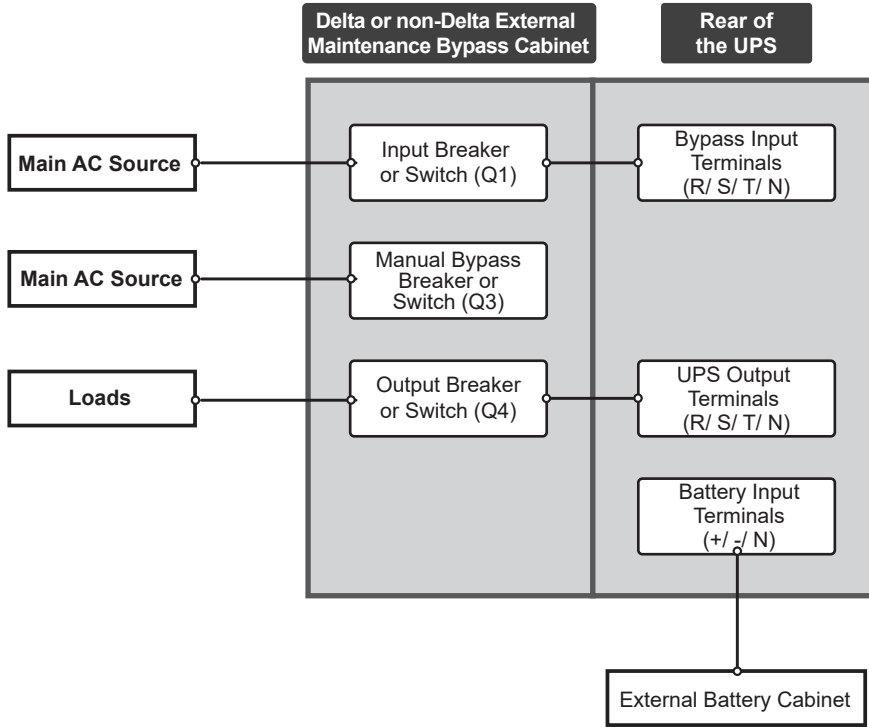

(Figure 5-15: Single Unit Single Input Wiring Diagram)



NOTE: The UPS will not work normally if the main AC source's neutral (N) is not firmly connected or not connected to the Delta or non-Delta External Maintenance Bypass Cabinet's AC Input neutral (N) terminal.

- 10 Follow **Figure 5-16** to ground the UPS, external battery cabinet(s), Delta or non-Delta external maintenance bypass cabinet and connected critical loads.

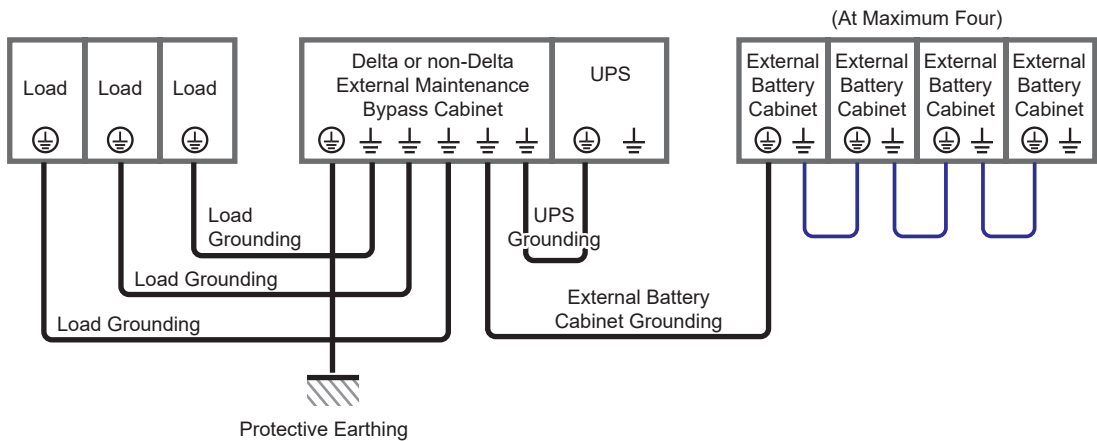

(Figure 5-16: Grounding Diagram_ Single Unit)

- **Dual Input (Single Unit)**

When there are two AC power sources, single unit wiring procedures are as follows.

- 1 Follow **5.5.2 Single Input/ Dual Input Modification** to modify the UPS from single input into dual input.
- 2 Follow the procedures 1 ~ 5 stated in the section of **Single Input (Single Unit)**.
- 3 Confirm that the UPS's Bypass Switch (Q0) is in the **OFF** position.
- 4 Confirm that the Delta or non-Delta external maintenance bypass cabinet's Input Breaker or Switch (Q1), Bypass Breaker or Switch (Q2), Manual Bypass Breaker or Switch (Q3) and the Output Breaker or Switch (Q4) are in the **OFF** position.
- 5 Follow **Table 5-2** to select proper input, output and battery cables.
- 6 Connect the main AC source/ bypass AC source/ output/ external battery cabinet's cables to the UPS and the Delta or non-Delta external maintenance bypass cabinet. For wiring, please refer to the following.

Figure 3-2: Dual Input Application_ UPS and Delta or non-Delta External Maintenance Bypass Cabinet Structure

Figure 5-12: Wiring Terminals_ AC Input & Bypass Input

Figure 5-13: Wiring Terminals_ UPS Output

Figure 5-14: Wiring Terminals_ Battery Input & Grounding

Table 5-3: Wiring between the UPS and the Delta or non-Delta External Maintenance Bypass Cabinet

Table 5-4: Delta or non-Delta External Maintenance Bypass Cabinet Wiring Information

Figure 5-17: Single Unit Dual Input Wiring Diagram

5.6 External Battery Cabinet Connection Warnings

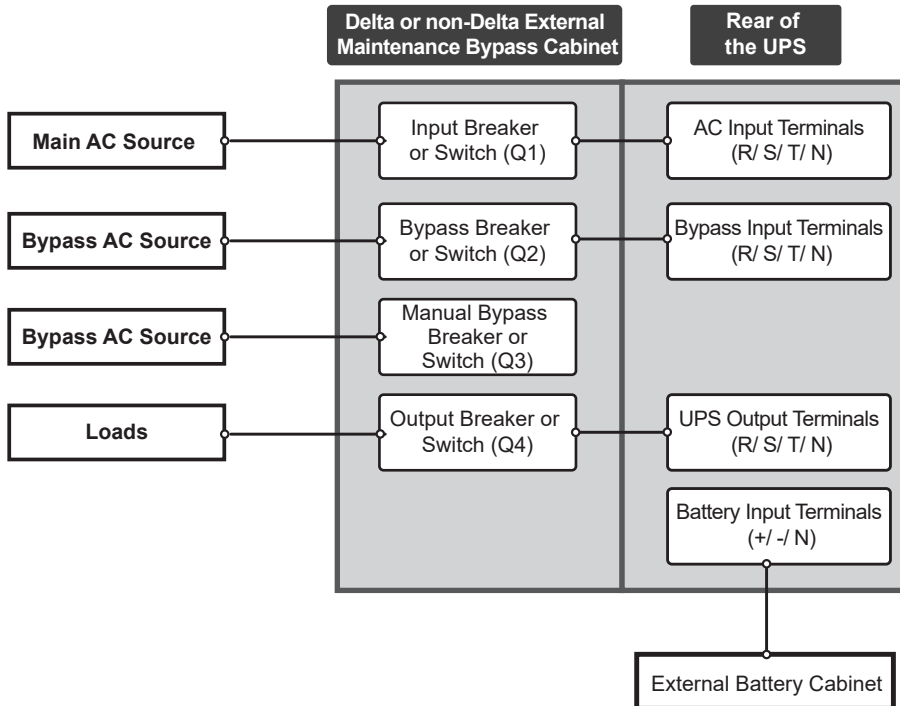

(Figure 5-17: Single Unit Dual Input Wiring Diagram)



NOTE: The UPS will not work normally if the main AC source's neutral (N) is not firmly connected or not connected to the Delta or non-Delta External Maintenance Bypass Cabinet's AC Input neutral (N) terminal.

- 7 Follow **Figure 5-16** to ground the UPS, external battery cabinet(s), Delta or non-Delta external maintenance bypass cabinet and connected critical loads.

5.5.4 Parallel Units Wiring



NOTE:

1. Only authorized Delta engineers or service personnel can perform installation, wiring, panel & cover removal, maintenance and operation. If you want to execute any action mentioned above by yourself, the action must be under the supervision of authorized Delta engineers or service personnel.
2. Up to eight UPS units can be paralleled for redundancy and capacity expansion. Only UPSs with the same capacity, voltage and frequency can be paralleled. Please only use the provided parallel cable to parallel the UPS units. Otherwise, parallel functions will fail.
3. When UPSs are paralleled, the length of each unit's bypass input cables plus output cables must be the same. This ensures that the parallel UPSs can equally share the critical loads in bypass mode.
4. The UPS rating voltage is 220/ 380Vac, 230/ 400Vac or 240/ 415Vac.
5. The external battery cabinet's rating voltage is ± 240 Vdc.
6. Before wiring, please read **5.5 Wiring** thoroughly.

- **Single Input (Parallel Units)**

When there is only one AC power source, parallel units' wiring procedures are as follows.

- ① Follow the procedures ① ~ ⑤ stated in the section of **Single Input (Single Unit)**.
- ② Confirm that each UPS's Bypass Switch (Q0) is in the **OFF** position.
- ③ Confirm that each Delta or non-Delta external maintenance bypass cabinet's Input Breaker or Switch (Q1), Manual Bypass Breaker or Switch (Q3) and the Output Breaker or Switch (Q4) are in the **OFF** position.
- ④ Follow **Table 5-2** to select proper input, output and battery cables.
- ⑤ Connect the main AC source/ output/ external battery cabinet's cables to each UPS and each Delta or non-Delta external maintenance bypass cabinet. For wiring, please refer to the following.

Figure 3-1: Single Input Application_ UPS and Delta or non-Delta External Maintenance Bypass Cabinet Structure

Figure 5-12: Wiring Terminals_ AC Input & Bypass Input

Figure 5-13: Wiring Terminals_ UPS Output

Figure 5-14: Wiring Terminals_ Battery Input & Grounding

Table 5-3: Wiring between the UPS and the Delta or non-Delta External Maintenance Bypass Cabinet

Table 5-4: Delta or non-Delta External Maintenance Bypass Cabinet Wiring Information

Figure 5-15: Single Unit Single Input Wiring Diagram

Figure 5-18: Parallel Units Single Input Wiring Diagram

5.6 External Battery Cabinet Connection Warnings

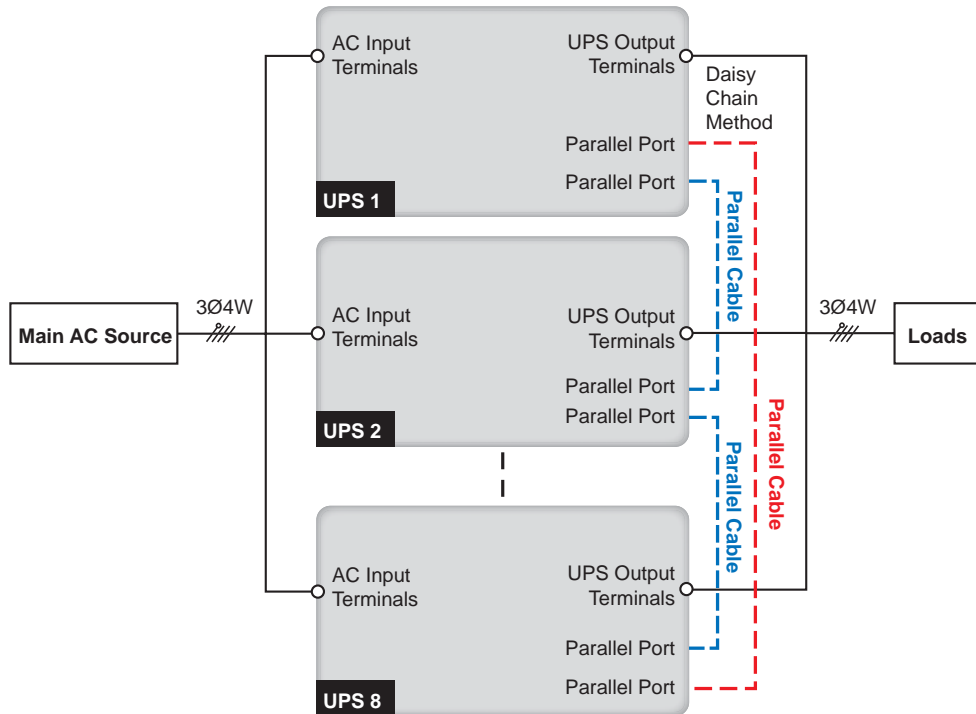

(Figure 5-18: Parallel Units Single Input Wiring Diagram)



NOTE: The UPS will not work normally if the main AC source's neutral (N) is not firmly connected or not connected to the Delta or non-Delta External Maintenance Bypass Cabinet's AC Input neutral (N) terminal.

- 6 Use the provided parallel cable to connect the parallel ports on the parallel units, Please refer to **Figure 4-3** for the parallel port location.
- 7 Follow **Figure 5-19** to ground the parallel UPS units, external battery cabinet(s), Delta or non-Delta external maintenance bypass cabinets and the connected critical loads.

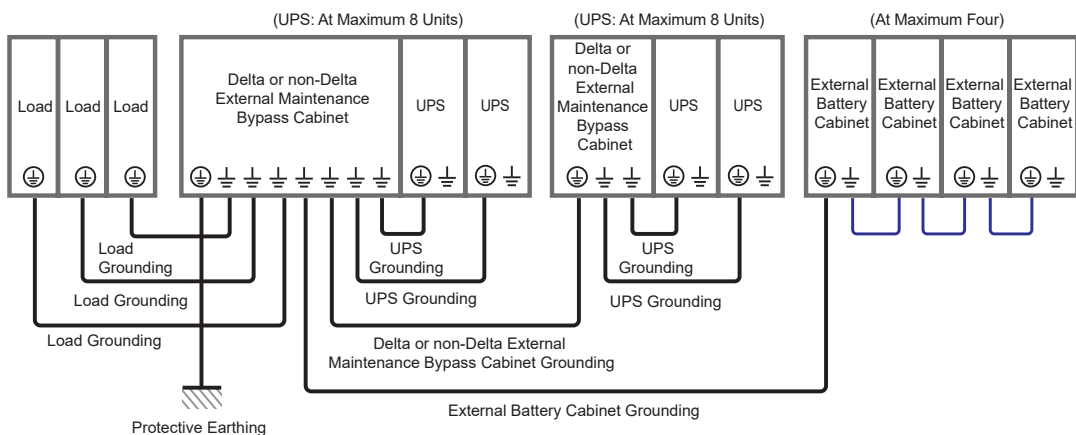

(Figure 5-19: Grounding Diagram_ Parallel Units)



WARNING:

Before start-up of the parallel units, qualified service personnel must set each UPS's '**Parallel Group ID**' (1 or 2) and '**Parallel ID**' (1~8) through the LCD. Otherwise, the parallel UPSs cannot be started. Please refer to **7.10.5 Parallel Setting**.

- **Dual Input (Parallel Units)**

When there are two AC power sources, parallel units' wiring procedures are as follows.

- 1 Follow **5.5.2 Single Input/ Dual Input Modification** to modify the UPS from single input to dual input.
- 2 Follow the procedures 1 ~ 2 stated in the section of **Single Input (Single Unit)**.
- 3 Confirm that each UPS's Bypass Switch (Q0) is in the **OFF** position.
- 4 Confirm that each Delta or non-Delta external maintenance bypass cabinet's Input Breaker or Switch (Q1), Bypass Breaker or Switch (Q2), Manual Bypass Breaker or Switch (Q3) and the Output Breaker or Switch (Q4) are in the **OFF** position.
- 5 Follow **Table 5-2** to select proper input, output and battery cables.
- 6 Connect the main AC source/ bypass AC source/ output/ external battery cabinet's cables to each UPS and each Delta or non-Delta external maintenance bypass cabinet. For wiring, please refer to the following.

Figure 3-2: Dual Input Application_ UPS and Delta or non-Delta External Maintenance Bypass Cabinet Structure

Figure 5-12: Wiring Terminals_ AC Input & Bypass Input

Figure 5-13: Wiring Terminals_ UPS Output

Figure 5-14: Wiring Terminals_ Battery Input & Grounding

Table 5-3: Wiring between the UPS and the Delta or non-Delta External Maintenance Bypass Cabinet

Table 5-4: Delta or non-Delta External Maintenance Bypass Cabinet Wiring Information

Figure 5-17: Single Unit Dual Input Wiring Diagram

Figure 5-20: Parallel Units Dual Input Wiring Diagram

5.6 External Battery Cabinet Connection Warnings

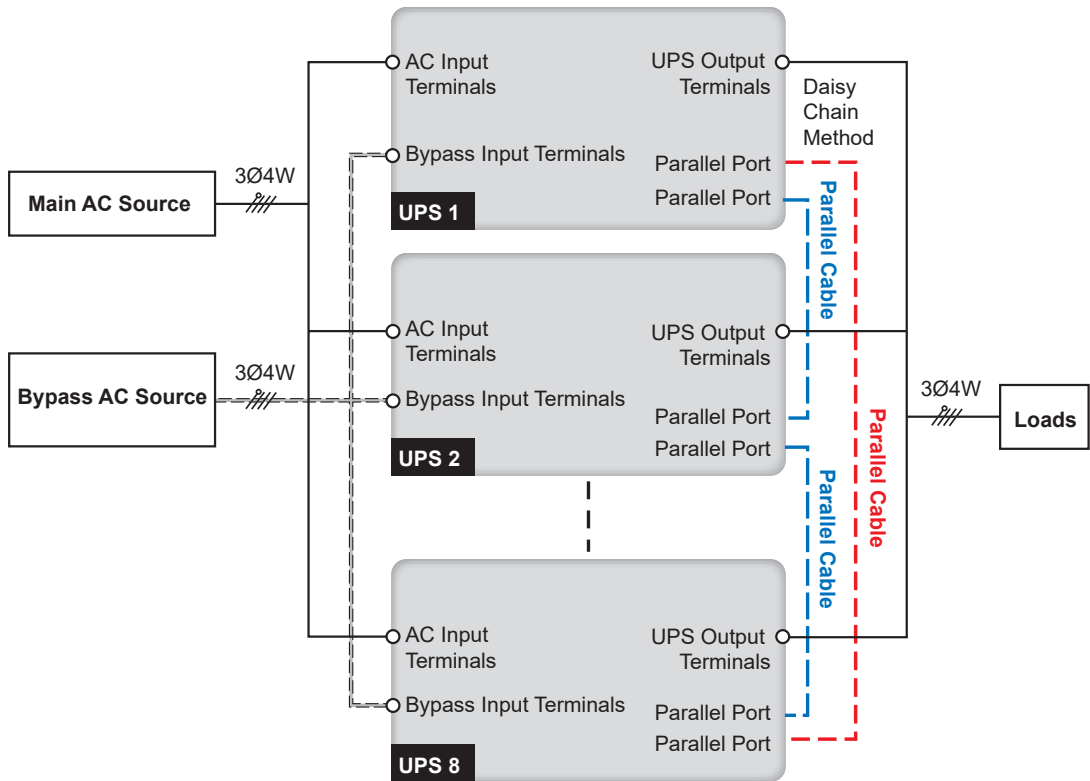

(Figure 5-20: Parallel Units Dual Input Wiring Diagram)



NOTE: The UPS will not work normally if the main AC source's neutral (N) is not firmly connected or not connected to the Delta or non-Delta External Maintenance Bypass Cabinet's AC Input neutral (N) terminal.

- 7 Use the provided parallel cable to connect the parallel ports on the parallel units, Please refer to **Figure 4-3** for the parallel port location.
- 8 Follow **Figure 5-19** to ground the parallel UPSs, external battery cabinet(s), Delta or non-Delta external maintenance bypass cabinets and connected critical loads.



WARNING:

Before start-up of the parallel units, qualified service personnel must set each UPS's '**Parallel Group ID**' (1 or 2) and '**Parallel ID**' (1~8) through the LCD. Otherwise, the parallel UPSs cannot be started. Please refer to **7.10.5 Parallel Setting**.

5.6 External Battery Cabinet Connection Warnings

You should connect the UPS with at least one external battery cabinet to ensure that the connected critical loads are protected when a power failure occurs. You can connect up to four units of external battery cabinets to the UPS.

- To ensure that the batteries are fully charged, please charge the batteries at least 8 hours before initial use of the UPS. The charging procedures are as follows.
 1. (A) Connect the UPS to the Delta external maintenance bypass cabinet (optional) and (B) connect the Delta external maintenance bypass cabinet (optional) to the main AC source, bypass AC source (for dual input only) and external battery cabinet. Please refer to **5. Installation and Wiring**. If you choose to use the non-Delta external maintenance bypass cabinet rather than the Delta external maintenance bypass cabinet (optional), please contact service personnel.
 2. Follow **6. UPS Operation** to turn on the Delta or non-Delta external maintenance bypass cabinet, UPS and external battery cabinet. After the UPS is powered on, the UPS will automatically charge the batteries.



WARNING:

You can connect the critical loads to the Delta or non-Delta external maintenance bypass cabinet only after the batteries are fully charged. This guarantees that the Delta or non-Delta external maintenance bypass cabinet can provide sufficient backup power to the critical loads connected when a power failure occurs.

- **Battery Parameters**

No.	Item	Description
1	Charge Voltage	Float charge voltage: $\pm 272\text{Vdc}$ (default)
		Equalized charge voltage: $\pm 280\text{Vdc}$ (default)
2	Charge Current	Default: $\pm 5\text{A}$ (per power module)
		Minimum: $\pm 6\text{A}$
		Maximum: $\pm 15\text{A}$ (per power module)
3	Low Battery Shutdown Voltage	$\pm 200 \sim \pm 220\text{Vdc}$ (default: 210Vdc)
4	The Number of Batteries	$12\text{V} \times 40 \text{ PCS}$ (default)



NOTE:

1. You can adjust the charge current from 6A to 15A (at maximum) in increments of 1A.
2. If you need to modify the default charge current setting and default low battery shutdown setting, please contact your local dealer or service personnel.
3. You can follow on-site requirements to choose $12\text{V} \times 30/ 32/ 34/ 36/ 38/ 40/ 42/ 44$ or 46 PCS batteries. The change of the number of batteries will influence the change of applied specifications. For battery selection, installation and replacement, please contact your local dealer or customer service.
4. The number of batteries that you set up via the LCD must be the same as that of on-site installation; otherwise, the batteries will be over charged, not fully charged or even seriously damaged.

- Only use the same type of batteries from the same supplier. Never use old, new and different Ah batteries at the same time.
- The number of batteries must meet UPS requirements.
- Do not connect the batteries in reverse.
- Use a voltage meter to measure whether the total voltage, after the external battery cabinet connection, is around 12.5Vdc × the total number of batteries.
- The default number of batteries is 40 PCS of 12Vdc batteries connected in string, and you should connect the external battery cabinet's neutral to the middle 20th and 21st batteries. You should use battery cables to connect the external battery cabinet with the '+', '-' and 'N' terminals marked on the Delta external maintenance bypass cabinet (optional). If you choose to use the non-Delta external maintenance bypass cabinet, please contact service personnel for battery configurations. For more information, please refer to **Table 5-3 ~ Table 5-4**.
- Please follow your UPS rating to install an appropriate protective device for the external battery cabinet. You can choose to install either (1) a DC circuit breaker or DC isolated switch connected in series with a DC fuse or (2) a DC circuit breaker. Please refer to **Table 5-5**.
- The capacity of the protective device must be consistent with the current shown in **Table 5-5**. If the type of the protective device is a fuse, it must be a fast-acting fuse with melting current 5 ~ 6 times of the rating current.

Table 5-5: External Battery Cabinet's Protective Device (Battery Default Q'ty: 12Vdc x 40 PCS)

UPS Capacity	Power Module Q'ty	Protective Device's Current	Protective Device's Voltage
200kVA/ 200kW	4	500A	1. 4-pole DC circuit breaker or DC isolated switch (per pole voltage ≥ 250Vdc) 2. 3-pole DC circuit breaker or DC isolated switch (per pole voltage ≥ 500Vdc) 3. DC fuse (voltage ≥ 500Vdc)
300kVA/ 300kW	6	800A	
400kVA/ 400kW	8	1000A	
500kVA/ 450kW	9	1200A	

**NOTE:**

1. **Table 5-5** is based on 12Vdc x 40 PCS batteries (default). If you install different number of batteries, please contact Delta service personnel for protective device's current and voltage.
 2. The above-mentioned DC fuse and DC circuit breaker are optional. If you want to buy any of them, please contact Delta service personnel.
 3. If you need to parallel multiple units of external battery cabinets, please contact Delta service personnel for relevant information.
 4. To extend backup time, you can parallel up to four units of external battery cabinets to the UPS. Please note that (1) the number of batteries in each of the parallel external battery cabinets and (2) the cable length of each string of the batteries must be the same.
 5. If the number of batteries is lower than 36, the UPS capacity should be de-rated to 80%; otherwise, it will trigger power module over temperature protection and the UPS will run in bypass mode.
- For information about the external battery cabinet connection and wiring, please refer to **Table 5-3**, **Table 5-4** and **Table 5-5**. For the external battery cabinet's grounding information, please refer to **Figure 5-16** and **Figure 5-19**. Only qualified service personnel can perform wiring or you can perform wiring only under the supervision of qualified service personnel.
 - The external battery cabinet's protective device must be planned and designed by qualified service personnel. There are three types of protective devices, which are (1) DC circuit breaker, (2) DC isolated switch, and (3) DC fuse (please refer to **Table 5-5**). When choosing the external battery cabinet's protective device, please take the following factors into consideration: (1) over current between the UPS and battery circuit, (2) short circuit, (3) wire/ cable materials, and (4) local electrical regulations. If you have any questions about the external battery cabinet's protective device, please contact Delta service personnel. Please refer to **Figure 5-21 ~ Figure 5-24** for the installation of the external battery cabinet's protective device.
 - A battery can present a risk of electric shock and high short-circuit current. Please handle it carefully. For selection of the protective device for the external battery cabinet, a DC circuit breaker or DC isolated switch connected in series with a DC fuse is strongly suggested. Please refer to **Figure 5-21 ~ Figure 5-22**.
 - If you only use a DC circuit breaker as the external battery cabinet's protective device, it is suggested that you parallel several units of external battery cabinets and separately install an independent DC circuit breaker for each of the parallel external battery cabinets in order to enhance the sensitivity of current protection.

1. Option 1: A DC circuit breaker or DC isolated switch connected in series with a DC fuse (for safety reasons, this option is suggested)

- 1) A 4-pole DC circuit breaker or DC isolated switch (per pole voltage $\geq 250\text{Vdc}$) connected in series with a DC fuse (voltage $\geq 500\text{Vdc}$)

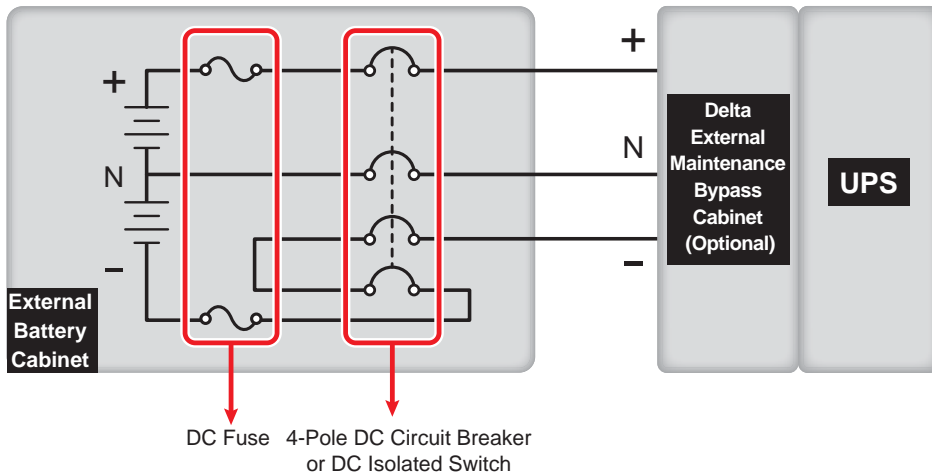

(Figure 5-21: Installation of a 4-Pole DC Circuit Breaker or DC Isolated Switch Connected in Series with a DC Fuse)

- 2) A 3-pole DC circuit breaker or DC isolated switch (per pole voltage $\geq 500\text{Vdc}$) connected in series with a DC fuse (voltage $\geq 500\text{Vdc}$)

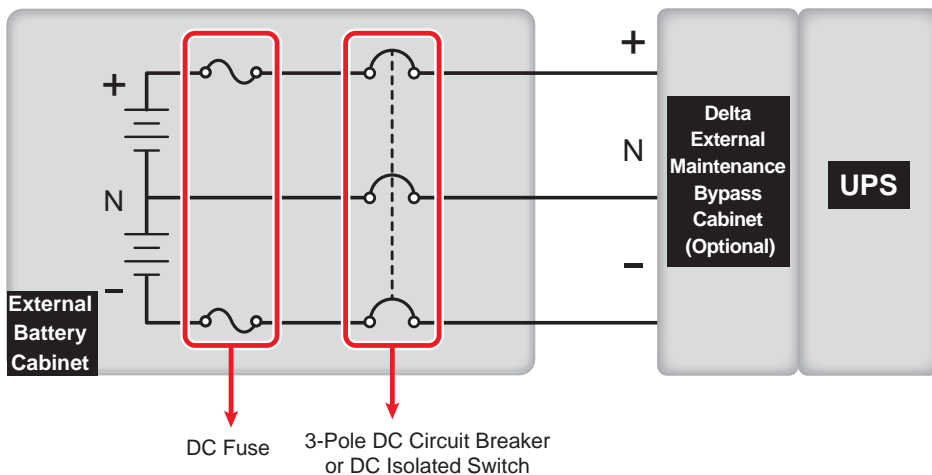

(Figure 5-22: Installation of a 3-Pole DC Circuit Breaker or DC Isolated Switch Connected in Series with a DC Fuse)

2. Option 2: A DC circuit breaker

- 1) A 4-pole DC circuit breaker (per pole voltage $\geq 250\text{Vdc}$)

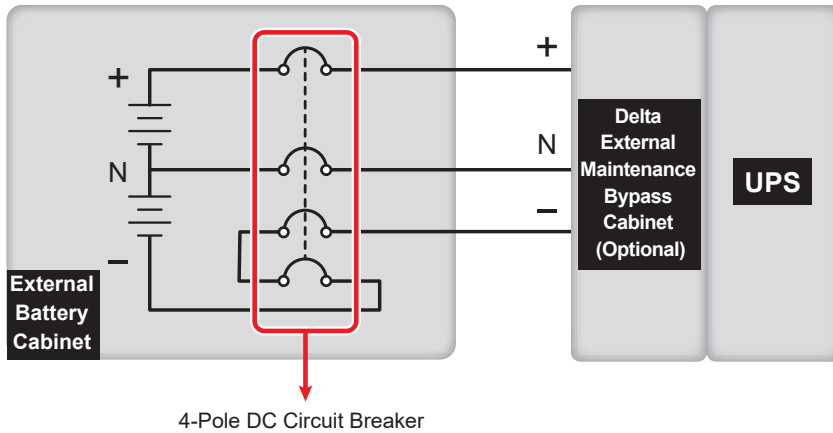

(Figure 5-23: Installation of a 4-Pole DC Circuit Breaker)

- 2) A 3-pole DC circuit breaker (per pole voltage $\geq 500\text{Vdc}$)

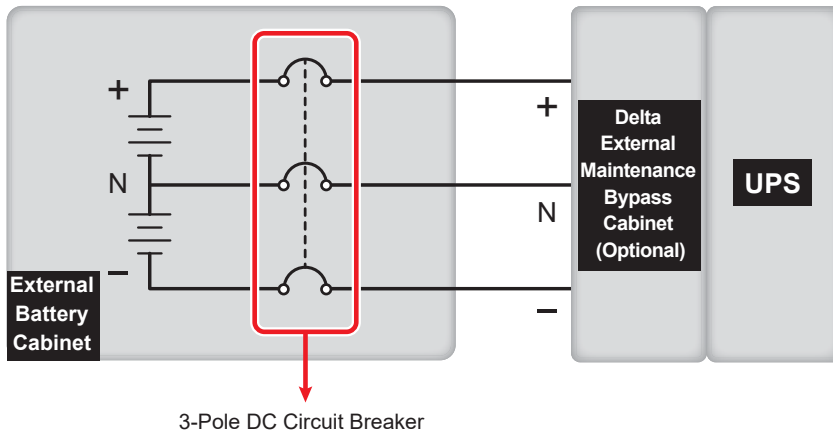

(Figure 5-24: Installation of a 3-Pole DC Circuit Breaker)



NOTE: Figure 5-21 ~ Figure 5-24 show the connections between the UPS, Delta external maintenance bypass cabinet (optional) and external battery cabinet. If you choose to use the non-Delta external maintenance bypass cabinet (user-supplied), please contact service personnel for battery wiring and configurations.

- To save on your costs and installation space, parallel UPSs (at maximum 8 units) can share external battery cabinet(s). For relevant information, please refer to **3.4 Common Battery (Only for Parallel UPSs connecting to the Same External Battery Cabinet(s))**.

**WARNING:**

- Before performing battery/ battery cabinet replacement, please turn off the external battery cabinet's breaker (Q5) to isolate the battery power from the UPS completely.
- A battery can present a risk of electric shock and high short-circuit current. Servicing of batteries and battery cabinets must be performed or supervised by qualified service personnel knowledgeable in batteries, battery cabinets and the required precautions. Keep unauthorized personnel away from batteries and battery cabinets.

- External Battery Cabinet Alarm**

When any external battery cabinet connected to the UPS has the following problems, the UPS system will sound an alarm. Please see the table below.

No.	External Battery Cabinet Status	Alarm
1	Battery Abnormal - Reversed	Sounds 50ms every second.
2	Battery Ground Fault	Sounds 50ms every second.
3	Battery Over Temperature	Sounds 50ms every second.
4	Battery Under Temperature	Sounds 50ms every second.
5	Battery Breaker Off	Sounds 50ms every 3 seconds.
6	Battery Disconnected (Missing)	Sounds once every second.
7	Battery Over Charged	Long beep
8	Battery Test Fail	Sounds 50ms every second.
9	Battery End of Discharge Imminent	Sounds 50ms every second.
10	Battery End of Discharge	Long beep
11	Battery Lifetime Expired	Sounds 50ms every 3 seconds

5.7 STS Module

The hot swappable STS module has been installed inside the UPS in the Delta factory before shipment. Please see **Figure 5-25** for its location.

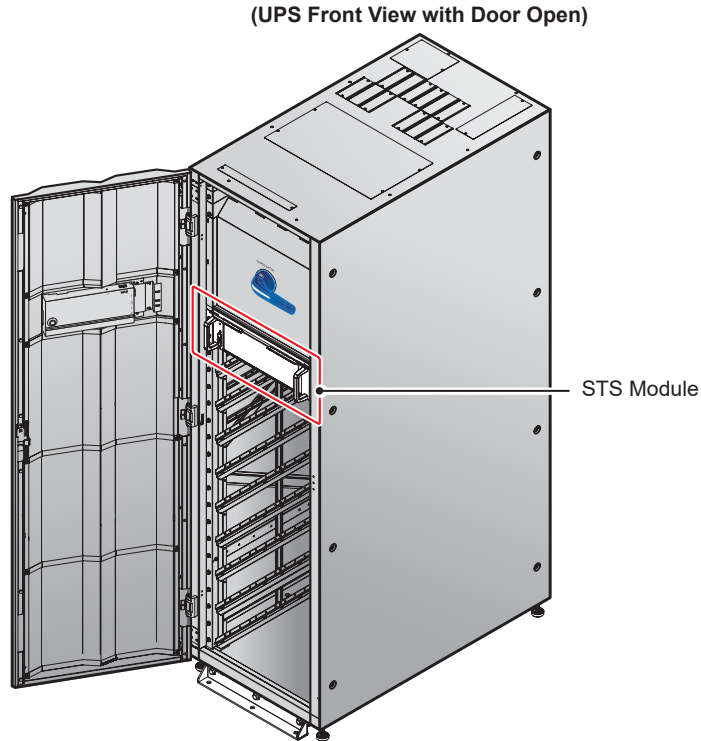

(Figure 5-25: STS Module Location)

For STS module illustration, please refer to **Figure 5-26**.

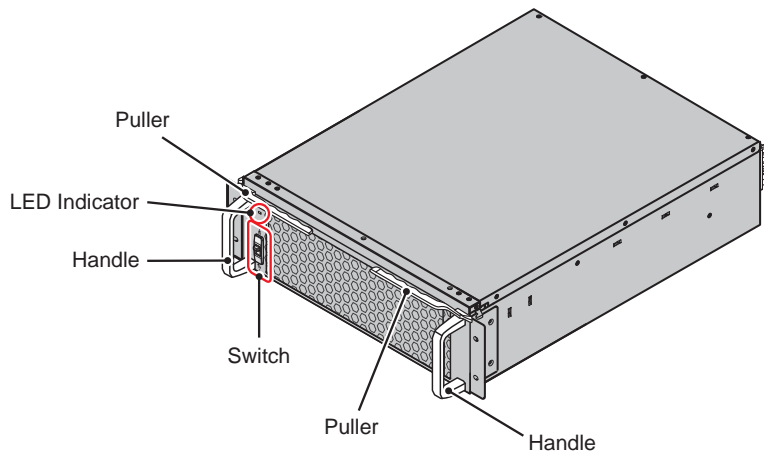

(Figure 5-26: STS Module)

5.7.1 STS Module Installation

The hot swappable STS module has been installed inside the UPS in the Delta factory before shipment. If the STS module is removed for some reasons and you want to re-install it, please follow the steps below.



WARNING:

1. Only qualified service personnel can perform the following installation procedures.
2. The STS module is heavy (> 28 kg). At least two people are required for handling.

- 1 Confirm that the STS module's switch is in the lower position () and the pullers are in the open status. Please refer to **Figure 5-27** and **Figure 5-28**.

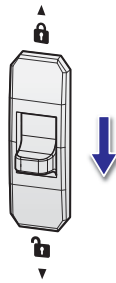

(Figure 5-27: Turn the STS Module's Switch to the Lower Position)

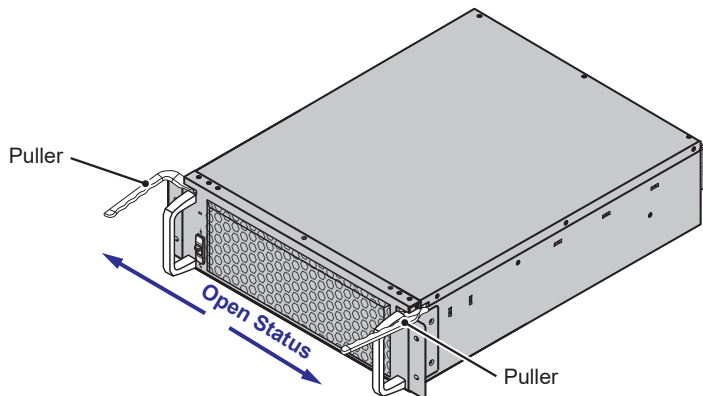

(Figure 5-28: Confirm the Pullers are in the Open Status)

- 2 Two people are required. Each person holds each handle of the STS module 1 and two people work together to insert the module into the designated slot 2. After that, one person holds the two pullers and push the two pullers inward 3 in order to push the module into the end of the UPS cabinet until it snaps into place. After that, the two pullers will be in the closed status.

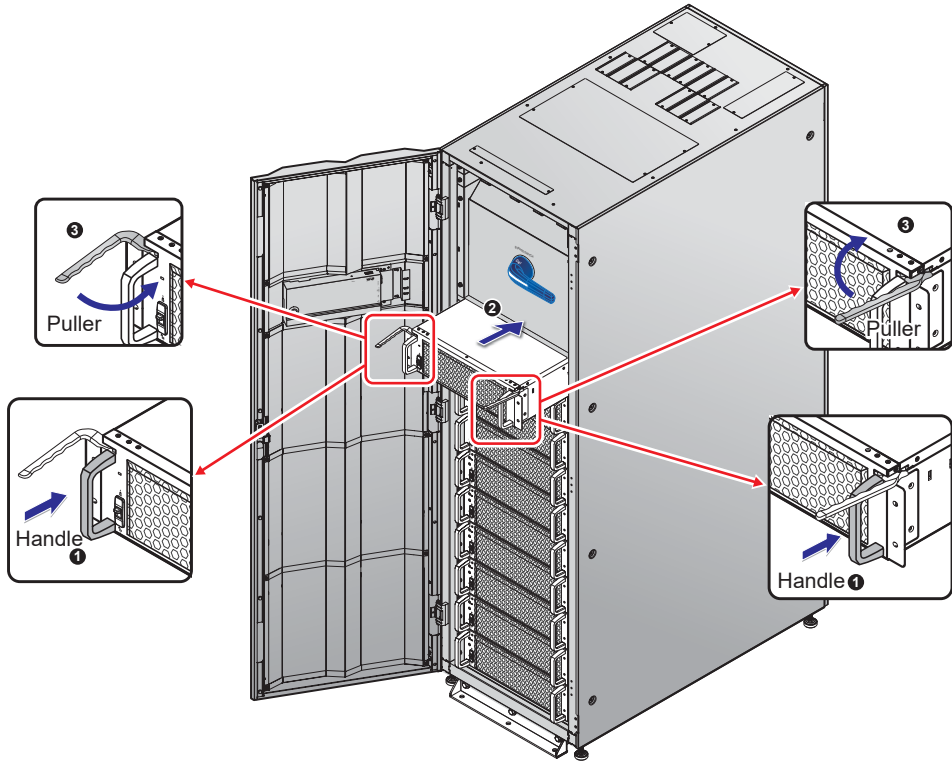

(Figure 5-29: Insert the STS Module into the UPS)

- 3 Re-install the four screws (removed during the STS module removal process) to firmly fix the STS module's bracket ears on the UPS cabinet.

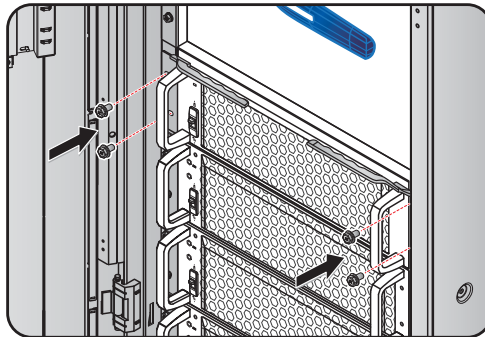

(Figure 5-30: Fix the STS Module on the UPS)

- 4 Turn the STS module's switch to the upper position ().

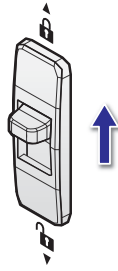

(Figure 5-31: Turn the STS Module's Switch to the Upper Position)

5.7.2 STS Module Removal



WARNING:

1. Only qualified service personnel can perform the following removal procedures.
2. The STS module is heavy (> 28 kg). At least two people are required for handling.

- 1 Turn the STS module's switch to the lower position () and wait until the STS module's LED indicator becomes off.

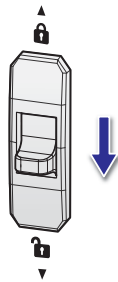

(Figure 5-32: Turn the STS Module's Switch to the Lower Position)

- 2 Unscrew the four screws shown in **Figure 5-33**.

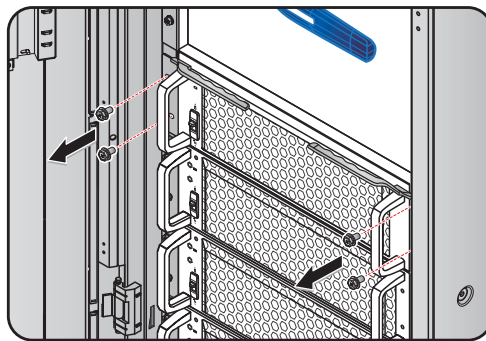

(Figure 5-33: Remove the Four Screws)

- 3 Two people are required. One person holds the STS module's two pullers and opens the two pullers outward ❶. After that, the STS module can be pulled out ❷ from the UPS cabinet. Another person holds the two handles ❸ and two people work together to pull out the STS module from the UPS cabinet. When the STS module cannot be pulled out any more, press the lock (see **Figure 5-35**) on the left side of the STS module in order to continuously pull out the module from the UPS cabinet.

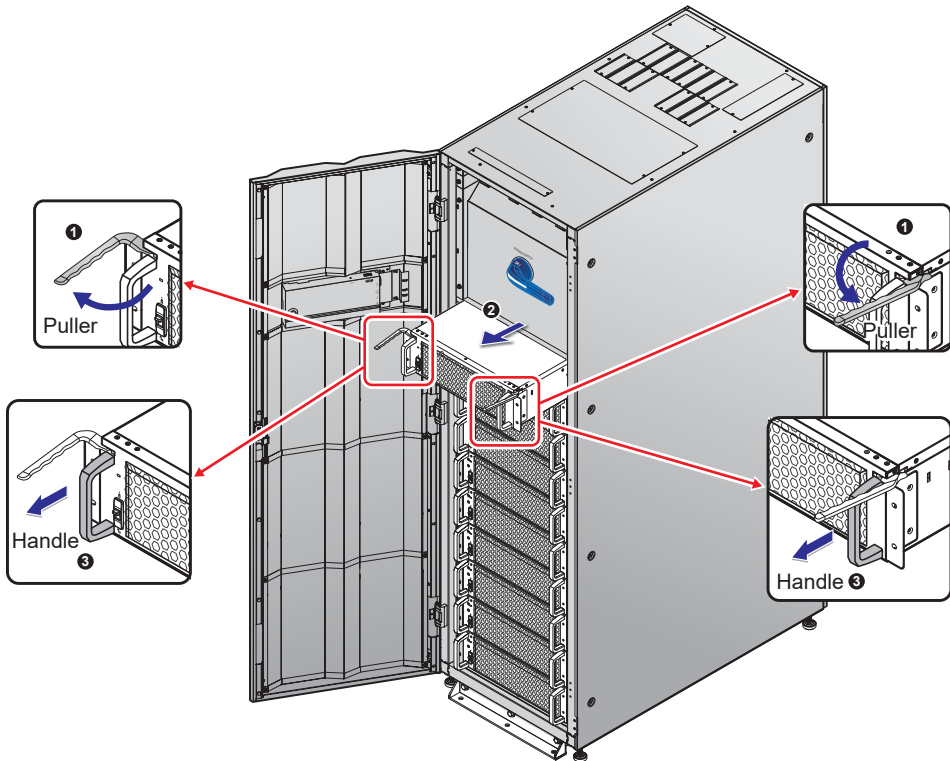

(Figure 5-34: Remove the STS Module from the UPS)

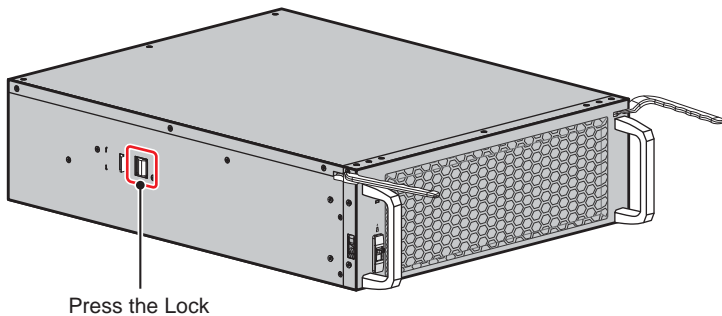

(Figure 5-35: Press the Lock of the STS Module)

5.7.3 STS Module's LED Indicator

The STS module's LED indicator shows its operation status. Please refer to the following table.

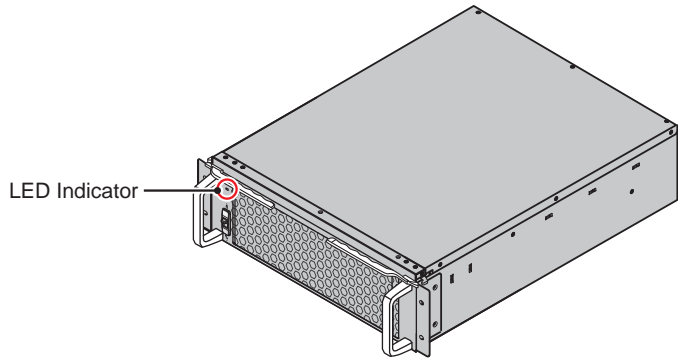



(Figure 5-36: STS Module's LED Indicator)

LED Indicator	Description
OFF	The STS module is OFF.
ON (yellow)	The STS module is working in bypass mode, ECO mode, or energy recycle mode.
Flashing (yellow)_ on for 0.3 second and off for 3 seconds	The STS module is abnormal.



NOTE:

In bypass mode, if you turn the STS module's switch to the lower position (), the STS module will shut down its output and its LED indicator will be off. 

5.8 Power Module (Optional)

The power module is optional (not included in the package of the UPS). It is hot swappable and each capacity is 55.6kVA/ 50kW. Please follow UPS capacity to install appropriate number of power modules.

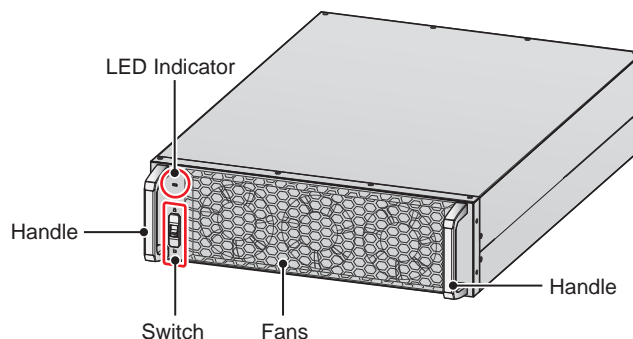

(Figure 5-37: Power Module (Optional))

Please see the table below for the power module's packing list.

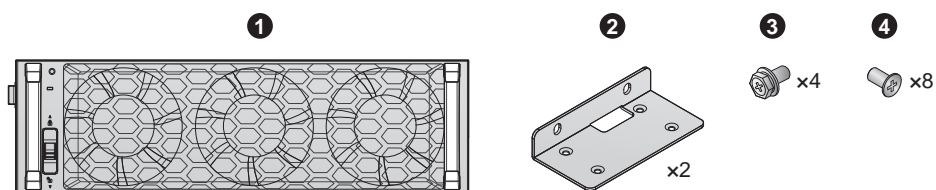

No.	Item	Q'ty
①	Power Module	1 PC
②	Bracket Ear	2 PCS
③	M6 Screw	4 PCS
④	M4 Screw	8 PCS

5.8.1 Power Module Installation

After following **5.4 Fixing the UPS** to firmly fix the UPS in the designated installation area, follow the following steps to install the power module into the UPS.



WARNING:

1. Only qualified service personnel can perform the following installation procedures.
2. The power module is heavy (> 36 kg). At least two people are required for handling.
3. Please follow UPS capacity to install appropriate number of power modules.

DPH 200 ~ 500kVA				
Capacity	200kVA/ 200kW	300kVA/ 300kW	400kVA/ 400kW	500kVA/ 450kW
Power Module Q'ty	4	6	8	9

4. To consider the center of gravity, please install the power modules from the top layer of the power module slot to the bottom layer of the power module slot in sequence.

- ① Confirm the power module's switch is in the lower position ().



(Figure 5-38: Turn the Power Module's Switch to the Lower Position)

- 2 Take out the two bracket ears, four M6 screws and eight M4 screws from the power module's package.
- 3 Use the provided eight M4 screws to fix the provided two bracket ears on the two sides of the power module. Please refer to **Figure 5-39**.

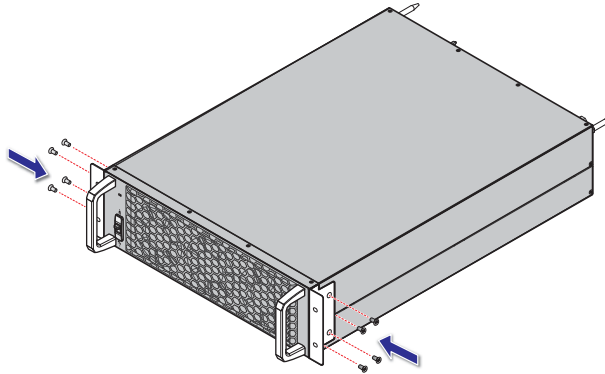

(Figure 5-39: Install the Two Bracket Ears)

- 4 Insert the power module into the power module slot until it snaps into place. Two people are required.



NOTE: To consider the center of gravity, please install the power modules from the top layer of the power module slot to the bottom layer of the power module slot in sequence.

(UPS Front View with Door Open)

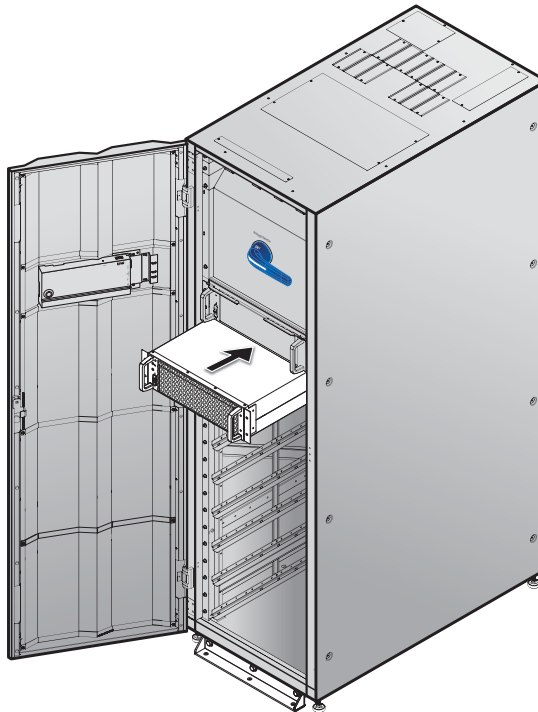

(Figure 5-40: Insert the Power Module into the UPS)

- 5 Use the provided four M6 screws to firmly fix the power module on the UPS.

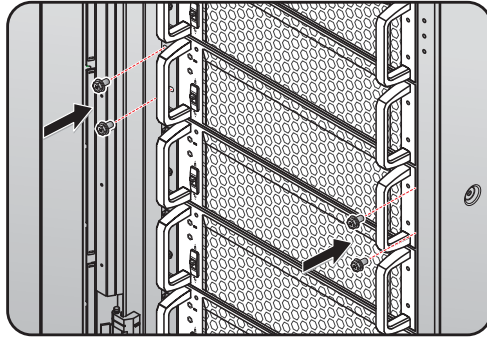

(Figure 5-41: Fix the Power Module on the UPS)

- 6 Turn the power module's switch to the upper position (▲). .

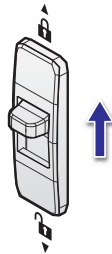

(Figure 5-42: Turn the Power Module's Switch to the Upper Position)

5.8.2 Power Module Removal



WARNING:

1. Before removing any power module, make sure that the remaining power modules can support the connected critical loads.
2. Only qualified service personnel can perform the following removal procedures.
3. The power module is heavy (> 36 kg). At least two people are required for handling.

- 1 Turn the power module's switch to the lower position (▼). . After that, the power module will start discharging. After discharging, the power module's LED indicator will be off.

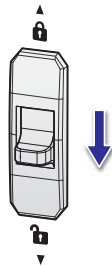

(Figure 5-43: Turn the Power Module's Switch to the Lower Position)

- 2 Use a screwdriver to remove the four screws shown in **Figure 5-44**.

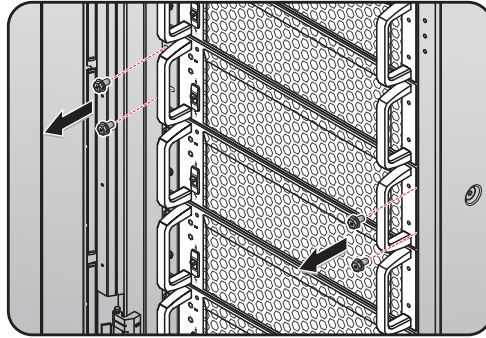

(Figure 5-44: Remove the Four Screws)

- 3 Pull out the power module from the slot (two people are required) (see **Figure 5-45**). When the power module cannot be pulled out any more, press the lock (see **Figure 5-46**) on the left side of the power module in order to continuously pull out the module from the UPS cabinet.

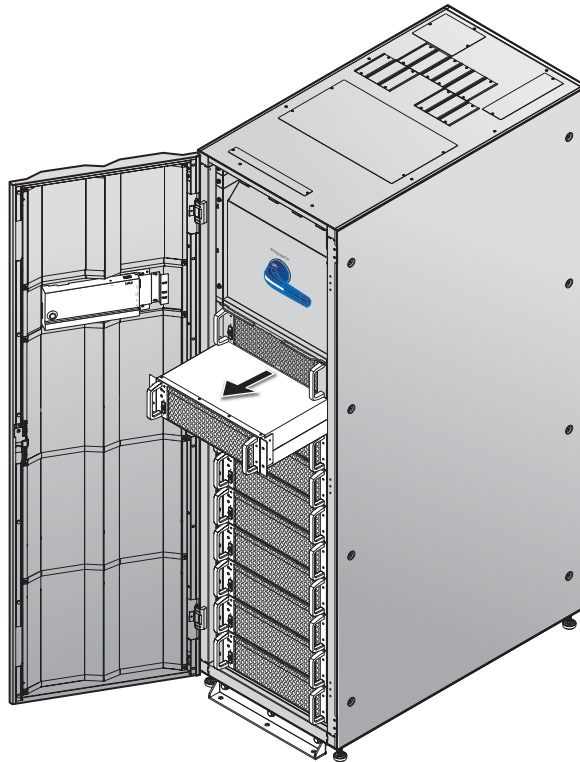

(Figure 5-45: Remove the Power Module)

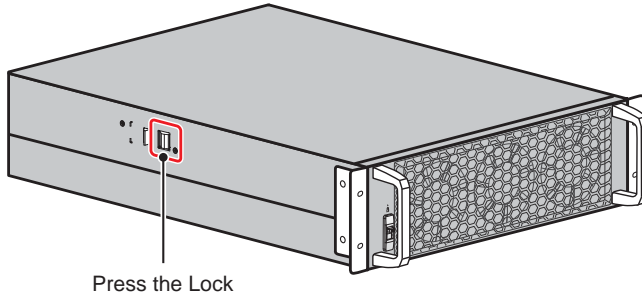

(Figure 5-46: Press the Lock of the Power Module)

5.8.3 Power Module's LED Indicator

The power module's LED indicator shows its operation status. Please refer to the following table.

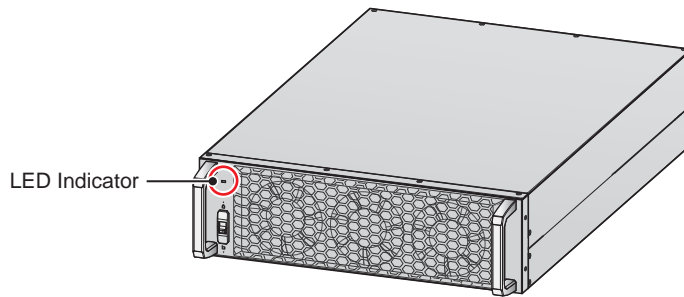

(Figure 5-47: Power Module's LED Indicator)

LED Indicator	Description
OFF	The power module is OFF.
ON (green)	<ol style="list-style-type: none"> 1. The power module is running in online mode or in battery mode. 2. The power module's inverter starts up. 3. The power module's PFC starts up.
Flashing (green)_ on for 2 seconds and off for 1 second	The power module is under discharging process.
Flashing (green)_ on for 0.3 second and off for 3 seconds	The power module is abnormal.



NOTE:

In online mode, if you turn the power module's switch to the lower position (), the power module will shut down its output and discharge the DC BUS voltage until the voltage reaches to a safety level. After that, the power module's LED indicator will be off.

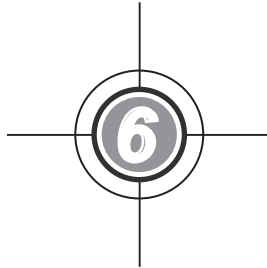

UPS Operation

- 6.1 Pre Start-up & Pre Turn-off Warnings for Single Unit and Parallel Units
- 6.2 Start-up Procedures
- 6.3 Turn-off Procedures

6.1 Pre Start-up & Pre Turn-off Warnings for Single Unit and Parallel Units



NOTE:

1. The information on the LCD screen presented in this chapter, including the UPS operation mode, machine number, date, time, total number of alarms, load%, battery remaining time, user login or administrator login, are for reference only. The actual screen displayed will depend on the actual operation situation.
2. The meaning of Q0, Q1, Q2, Q3, Q4 and Q5 in this user manual is described in the table below.

Code	Meaning
Q0	UPS bypass switch.
Q1	The input breaker or switch of the Delta or non-Delta external maintenance bypass cabinet.
Q2	The bypass breaker or switch of the Delta or non-Delta external maintenance bypass cabinet.
Q3	The manual bypass breaker or switch of the Delta or non-Delta external maintenance bypass cabinet.
Q4	The output breaker or switch of the Delta or non-Delta external maintenance bypass cabinet.
Q5	External battery cabinet's breaker.

3. Before operation, please make sure that **5. Installation and Wiring** has been completed in compliance with relevant instructions.
4. Before operation, please refer to **2.8 Tri-color LED Indicator & Buzzers** and **7. LCD Display & Settings**.

Single Unit

• Pre Start-up Warnings for Single Unit

1. Make sure that all of switches and breakers, including every external battery cabinet's breaker, are turned to the **OFF** position.
2. Make sure that the UPS and Delta or non-Delta External Maintenance Bypass Cabinet's voltage difference between the Neutral (N) and Ground (⊕) is < 3V.
3. Check if the wiring is correct. Ensure that the AC power's voltage, frequency, phase and battery type meet the UPS's requirements.
4. Check if all power modules are properly installed and every power module's switch is in the upper position (⬆). Please refer to **5.8 Power Module (Optional)** for more information.

- **Pre Turn-off Warnings for Single Unit**

If you perform turn-off procedures for single unit, all power will be completely cut off. Please make sure the critical loads connected to the UPS have already been safely shut down before you perform the turn-off procedures.

Parallel Units

- **Pre Start-up Warnings for Parallel Units**

1. You can parallel at maximum eight UPS units.
2. For parallel units, ensure that each parallel cable (provided) is connected well.
3. Make sure that all of switches and breakers, including every external battery cabinet's breaker, are turned to the **OFF** position.
4. Make sure that each UPS and Delta or non-Delta External Maintenance Bypass Cabinet's voltage difference between the Neutral (N) and Ground (\oplus) is $< 3V$.
5. Check if the wiring is correct. Ensure that the AC power's voltage, frequency, phase and battery type meet the UPS's requirements.
6. Check if all power modules are properly installed and every power module's switch is in the upper position (). Please refer to **5.8 Power Module (Optional)** for more information.
7. For parallel units, ensure that every operation procedure mentioned below is synchronized to all parallel UPSs.
8. For parallel application, if you just want to operate a specific UPS but not all parallel ones, please contact service personnel.

- **Pre Turn-off Warnings for Parallel Units**

1. If you want to turn off one of the parallel UPSs, please check whether the remaining parallel units' total capacity exceeds the total critical loads. If the remaining parallel units' total capacity is less than the total critical loads, all parallel units will shut down due to overload.
2. If you perform turn-off procedures for all parallel UPSs, all power will be completely cut off. Please make sure that the critical loads connected to the parallel UPSs have already been safely shut down before you perform the turn-off procedures.

6.2 Start-up Procedures

6.2.1 Online Mode Start-up Procedures



WARNING:

1. For parallel units, please follow **6.2.3 Bypass Mode Start-up Procedures** to turn on each parallel UPS. After confirming that parallel operation can be normally run, follow the following procedures step by step.
2. For parallel units, ensure that every operation procedure mentioned below is synchronized to all parallel UPSs.
3. For parallel application, if you just want to operate a specific UPS but not all parallel ones, please contact service personnel.

1 Ensure that the manual bypass breaker or switch (Q3) of the Delta or non-Delta external maintenance bypass cabinet is in the **OFF** position.

2 Switch **ON** each external battery cabinet's breaker (Q5).

3 **Single Input:**

Switch **ON** the bypass switch (Q0) of the UPS, the input breaker or switch (Q1) and the output breaker or switch (Q4) of the Delta or non-Delta external maintenance bypass cabinet.

Dual Input:

Switch **ON** the bypass switch (Q0) of the UPS, the input breaker or switch (Q1), the bypass breaker or switch (Q2) and the output breaker or switch (Q4) of the Delta or non-Delta external maintenance bypass cabinet.

4 After you switch **ON** the UPS's bypass switch (Q0), Delta or non-Delta external maintenance bypass cabinet's input breaker or switch (Q1) and bypass breaker or switch (Q2), each auxiliary power card's LED indicator will illuminate green and the following status will occur simultaneously.

1. The system and each power module will start initialization. After each power module finishes initialization, each power module's fans will start running, each power module will start establishing DC BUS voltage and each power module's LED indicator will illuminate green.
2. Each parallel communication card's LED indicator will illuminate red first and then each parallel communication card will start initialization. After initialization, the master parallel communication card's LED indicator will illuminate green and the backup communication card's LED indicator will illuminate yellow.

For the locations of parallel communication cards, auxiliary power cards, power modules and associated LED indicators, please refer to **Figure 6-1**.

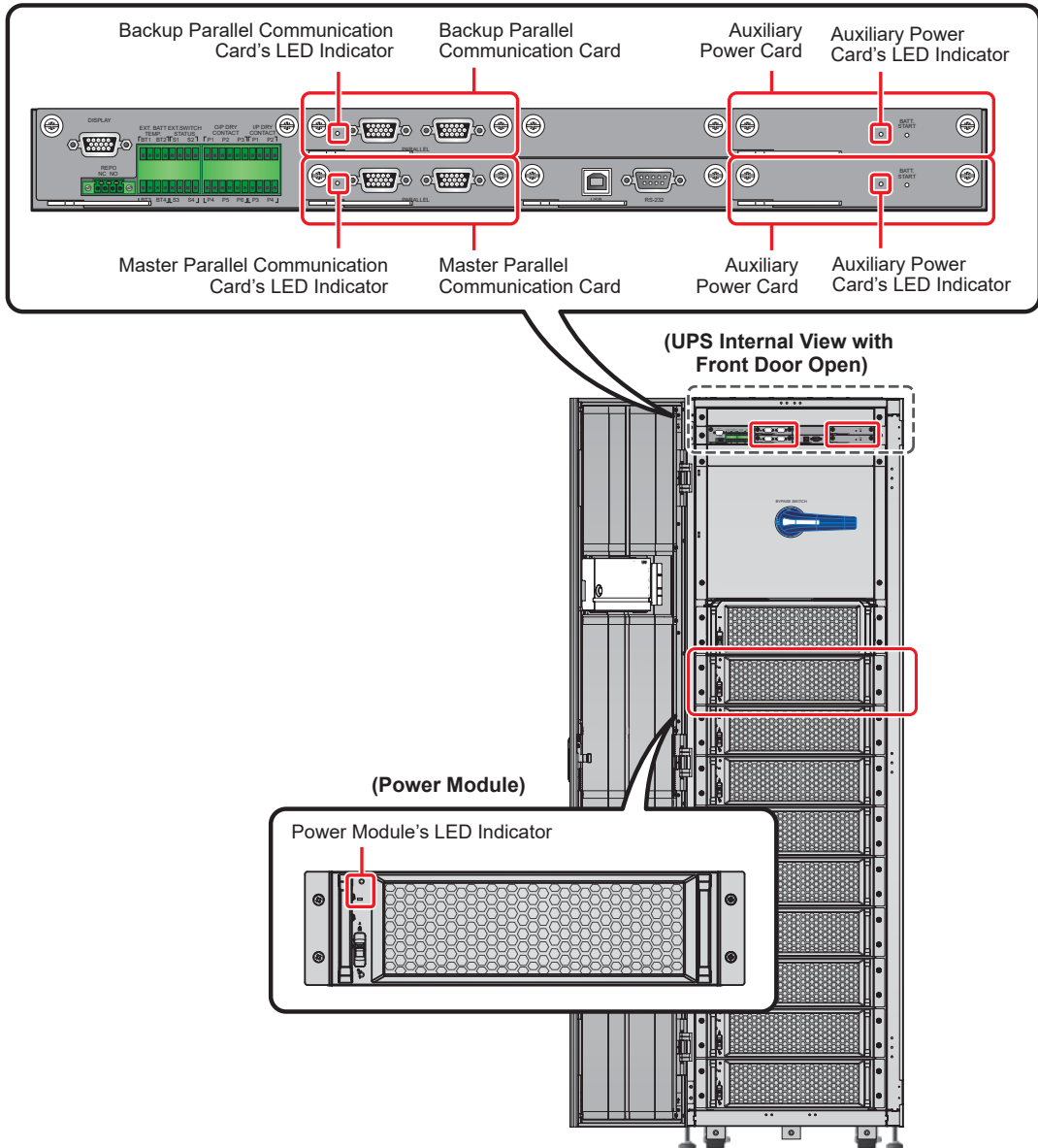

(Figure 6-1: The Locations of Parallel Communication Cards, Auxiliary Power Cards, Power Modules and Associated LED Indicators)

- 5) The LCD initial screen (see **Figure 6-2**) will appear within 40 seconds after the UPS's bypass switch (Q0), Delta or non-Delta external maintenance bypass cabinet's input breaker or switch (Q1) and bypass breaker or switch (Q2) are turned on.



(Figure 6-2 : LCD Initial Screen)

- 6 After 20 seconds of LCD initialization, the LCD will enter the **Main Screen**. For the **Main Screen** information, please refer to **7.6 Main Screen**.

Now, each power module keeps running and its LED indicator remains green. After each power module finishes establishing DC BUS voltage, the charger will start to charge the batteries.

If the bypass AC source is within the normal range, the UPS will transfer to run in bypass mode, the LCD screen will show as **Figure 6-3** and the tri-color LED indicator will illuminate yellow. For the location of the tri-color LED indicator, please refer to **Figure 2-11**.

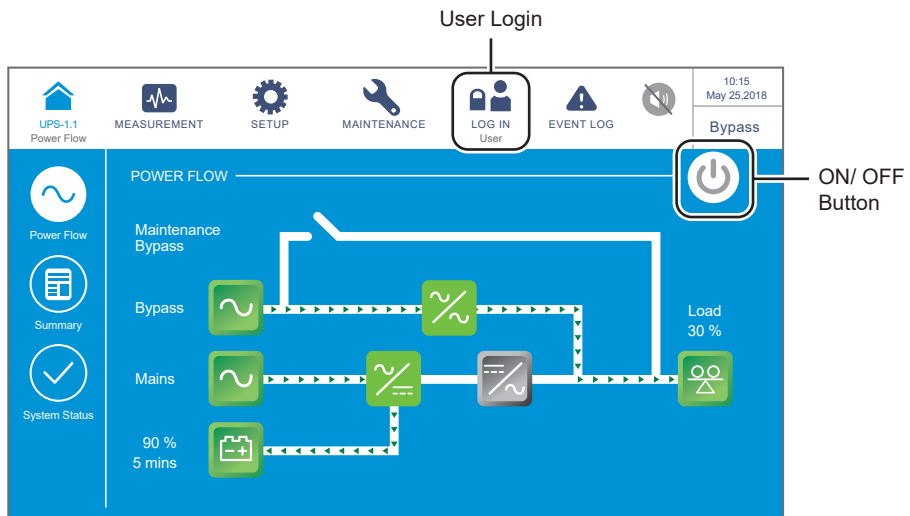

(Figure 6-3 : Main Screen_ User Login & ON/ OFF Button Location)

- 7 Press the ON/ OFF button () once and the following screen will pop up to ask you if you want to power on the UPS's inverter. Please select 'YES'.

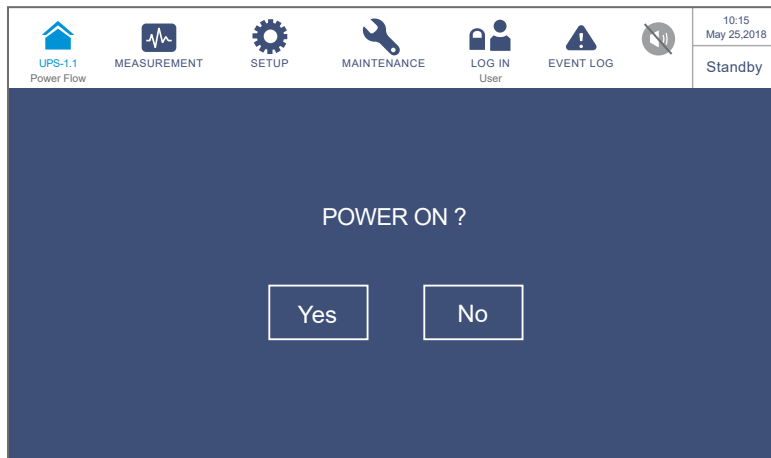

(Figure 6-4: Power on Reminder Screen)

- 8 After selection of 'YES' to start up the UPS's inverter, each power module will start up and perform self-inspection. At the same time, the system begins synchronization with the bypass AC source. After the self-inspection is completed, the UPS will automatically transfer to run in online mode, the tri-color LED indicator will illuminate green and the following screen will appear. For the tri-color LED indicator location, please refer to **Figure 2-11**.

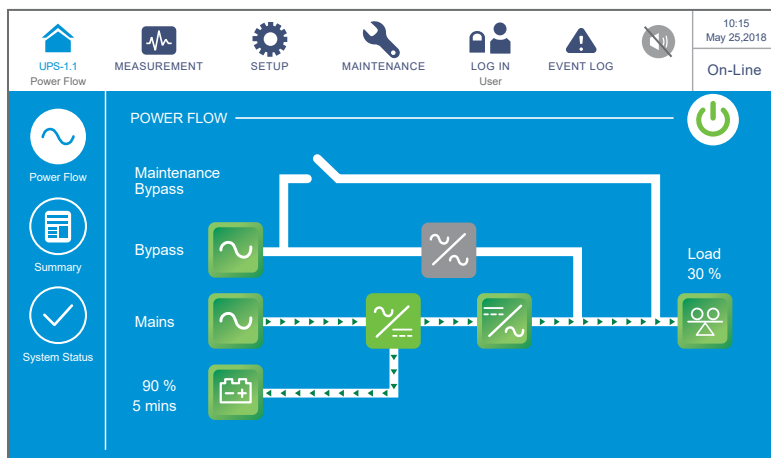

(Figure 6-5 : Online Mode Screen)

6.2.2 Battery Mode Start-up Procedures



WARNING:

1. For parallel units, please follow **6.2.3 Bypass Mode Start-up Procedures** to turn on each parallel UPS. After confirming that parallel operation can be normally run, follow the following procedures step by step.
2. For parallel units, ensure that every operation procedure mentioned below is synchronized to all parallel UPSs.
3. For parallel application, if you just want to operate a specific UPS but not all parallel ones, please contact service personnel.

- 1 Ensure that the manual bypass breaker or switch (Q3) of the Delta or non-Delta external maintenance bypass cabinet is in the **OFF** position.
- 2 Switch **ON** each external battery cabinet's breaker (Q5).
- 3 Switch **ON** the Delta or non-Delta external maintenance bypass cabinet's output breaker or switch (Q4).
- 4 Press any of the **BATT. START** buttons (see **Figure 7-2**) for one second and release it. After that, each auxiliary power card's LED indicator will illuminate green and the following status will occur simultaneously.
 1. The system and each power module will start initialization. After each power module finishes initialization, each power module's fans will start running.
 2. Each parallel communication card's LED indicator will illuminate red first and then each parallel communication card will start initialization. After initialization, the master parallel communication card's LED indicator will illuminate green and the backup communication card's LED indicator will illuminate yellow.

For the locations of parallel communication cards, auxiliary power cards, power modules and associated LED indicators, please refer to **Figure 6-1**.

- 5 The LCD initial screen (see **Figure 6-6**) will appear within 40 seconds after each auxiliary power card's LED indicator illuminates green.



(Figure 6-6 : LCD Initial Screen)

- 6 After 20 seconds of LCD initialization, the LCD will enter the **Main Screen** shown in **Figure 6-7** and the tri-color LED indicator will illuminate yellow. For the location of the tri-color LED indicator, please refer to **Figure 2-11**.

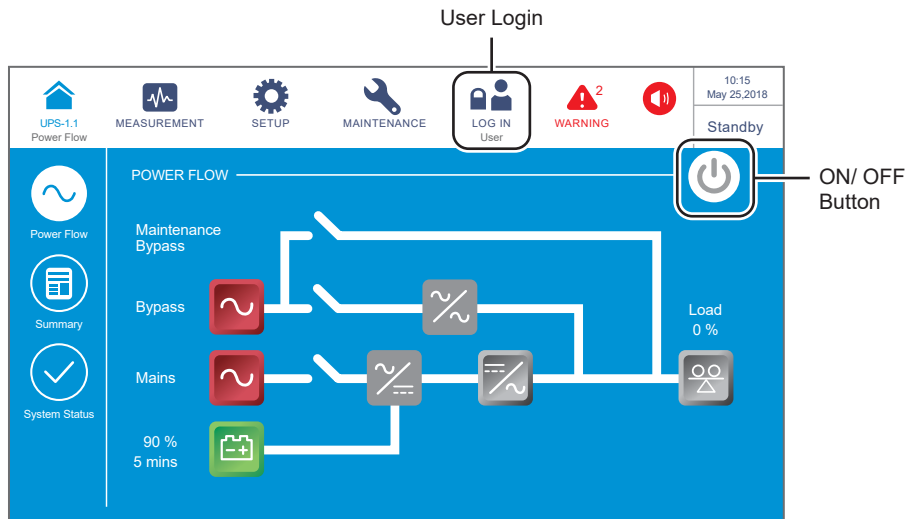

(Figure 6-7 : Main Screen_ User Login & ON/ OFF Button Location)

- 7 Press the ON/ OFF button () once and the following screen will pop up to ask you if you want to power on the UPS's inverter. Please select 'YES'.

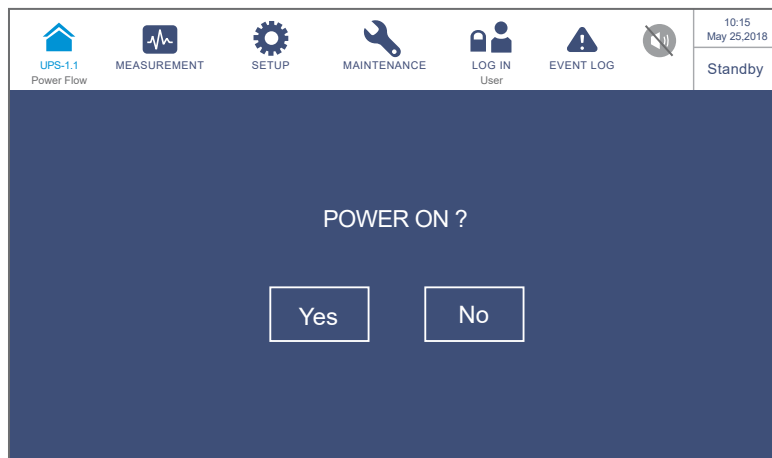

(Figure 6-8: Power On Reminder Screen)

- 8 After selection of 'YES' to start up the UPS's inverter, each power module will start up, each power module's LED indicator will illuminate green and each power module will perform self-inspection. After the self-inspection is completed, the UPS will automatically transfer to run in battery mode. At this moment, the tri-color LED indicator illuminates yellow and the following screen appears. For the tri-color LED indicator location, please refer to **Figure 2-11**.

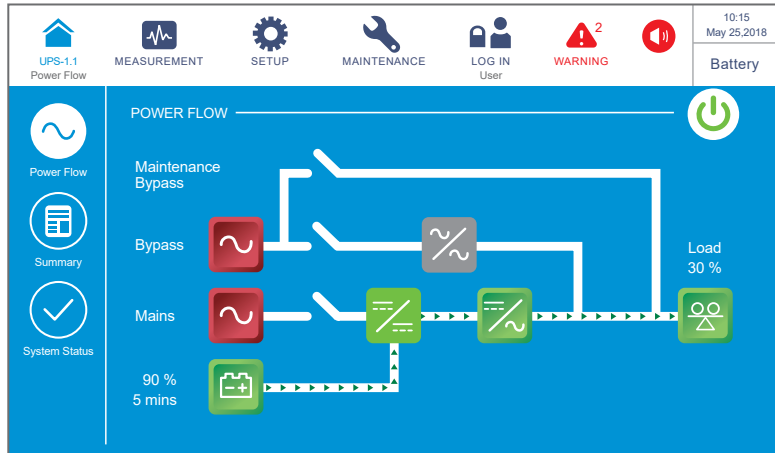

(Figure 6-9 : Battery Mode Screen)

6.2.3 Bypass Mode Start-up Procedures



WARNING:

1. For parallel units, ensure that every operation procedure mentioned below is synchronized to all parallel UPSs.
2. For parallel application, if you just want to operate a specific UPS but not all parallel ones, please contact service personnel.

① Ensure that the manual bypass breaker or switch (Q3) of the Delta or non-Delta external maintenance bypass cabinet is in the **OFF** position.

② Switch **ON** each external battery cabinet's breaker (Q5).

③ **Single Input:**

Switch **ON** the bypass switch (Q0) of the UPS and the input breaker or switch (Q1) of the Delta or non-Delta external maintenance bypass cabinet.

Dual Input:

Switch **ON** the bypass switch (Q0) of the UPS, the input breaker or switch (Q1) and the bypass breaker or switch (Q2) of the Delta or non-Delta external maintenance bypass cabinet.

④ After you switch **ON** the UPS's bypass switch (Q0), Delta or non-Delta external maintenance bypass cabinet's input breaker or switch (Q1) and bypass breaker or switch (Q2), each auxiliary power card's LED indicator will illuminate green and the following status will occur simultaneously.

1. The system and each power module will start initialization. After each power module finishes initialization, each power module's fans will start running, each power module will start establishing DC BUS voltage and each power module's LED indicator will illuminate green.
2. Each parallel communication card's LED indicator will illuminate red first and then each parallel communication card will start initialization. After initialization, the master parallel communication card's LED indicator will illuminate green and the backup communication card's LED indicator will illuminate yellow.

For the locations of parallel communication cards, auxiliary power cards, power modules and associated LED indicators, please refer to **Figure 6-1**.

- 5) The LCD initial screen (see **Figure 6-10**) will appear within 40 seconds after the UPS's bypass switch (Q0), Delta or non-Delta external maintenance bypass cabinet's input breaker or switch (Q1) and bypass breaker or switch (Q2) are turned on.



(Figure 6-10 : LCD Initial Screen)

- 6) After 20 seconds of LCD initialization, the LCD will enter the **Main Screen**. For the **Main Screen** information, please refer to **7.6 Main Screen**.

Now, each power module keeps running and its LED indicator remains green. After each power module finishes establishing DC BUS voltage, the charger will start to charge the batteries.

If the bypass AC source is within the normal range, the UPS will transfer to run in bypass mode, the LCD screen will show as **Figure 6-11** and the tri-color LED indicator will illuminate yellow. For the location of the tri-color LED indicator, please refer to **Figure 2-11**.

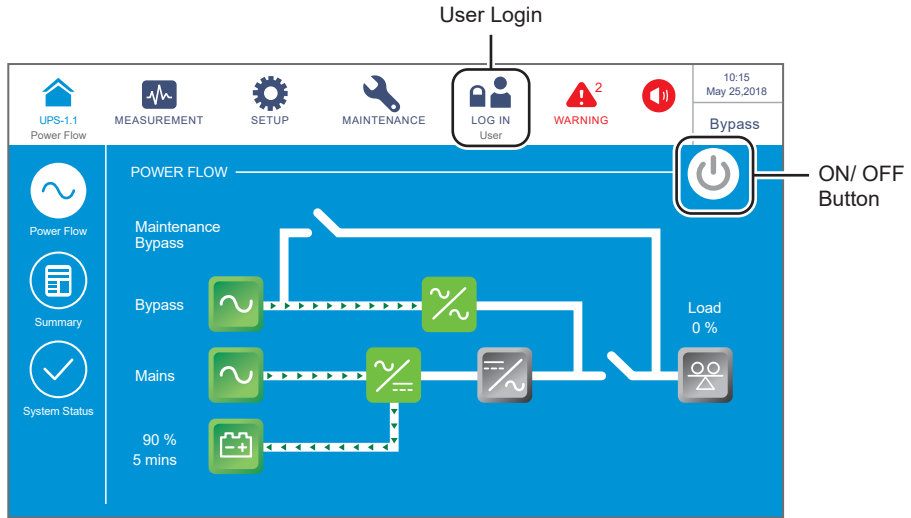

(Figure 6-11 : Main Screen_ User Login & ON/ OFF Button Location)

- 7) For parallel application, please check each parallel UPS's parallel settings. Please note that each parallel UPS's parallel ID No. must be different, and parallel group No., input, output and battery settings must be the same.
- 8) For parallel application, press the icon () located in the upper left corner of the screen and check if the total number of the parallel UPSs is correct. The UPS with the smallest parallel ID No. is defined as the master unit. Please refer to **Figure 6-12**.

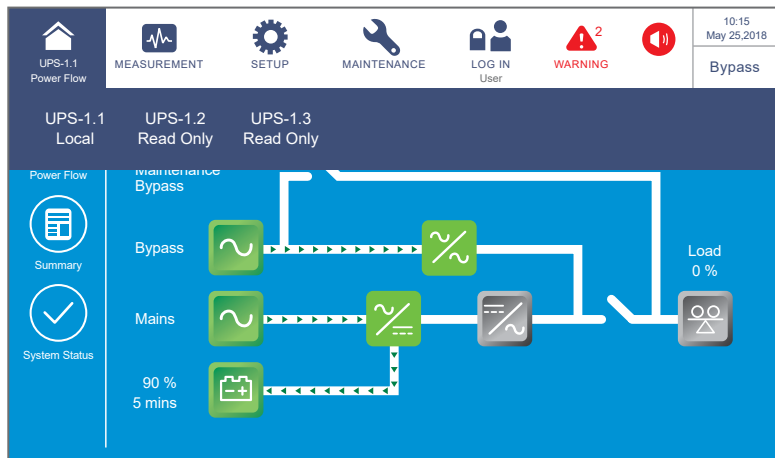

(Figure 6-12: Parallel ID No. Inquiry Screen)

- 9) For single unit, turn on the Delta or non-Delta external maintenance bypass cabinet's output breaker or switch (Q4).
For parallel units, ensure that the output voltage difference between each parallel UPS is below 3V. If larger than 3V, it means abnormal and please contact service personnel

immediately. If below 3V, turn on each Delta or non-Delta external maintenance bypass cabinet's output breaker or switch (Q4).

Now, the tri-color LED indicator illuminates yellow and the LCD shows the following screen (see **Figure 6-13**). For the location of the tri-color LED indicator, please refer to **Figure 2-11**.

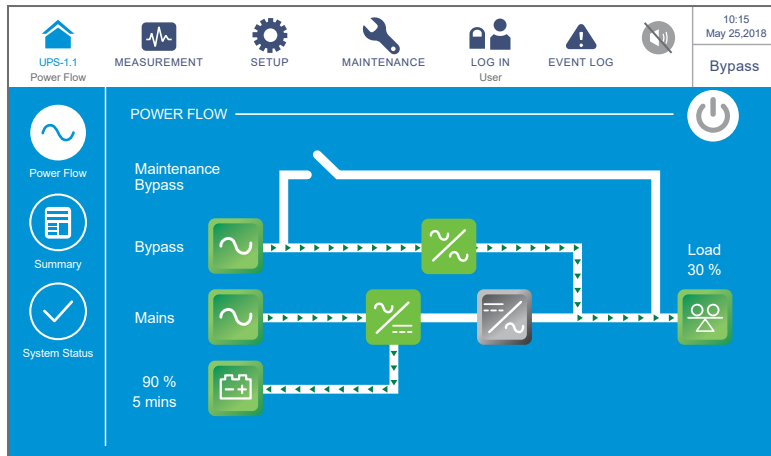

(Figure 6-13: Bypass Mode Screen)

6.2.4 Manual Bypass Mode Start-up Procedures



WARNING:

1. For parallel units, ensure that every operation procedure mentioned below is synchronized to all parallel UPSs.
2. For parallel application, if you just want to operate a specific UPS but not all parallel ones, please contact service personnel.
3. Please note that you can turn on the Delta or non-Delta external maintenance bypass cabinet's manual bypass breaker or switch (Q3) only when the UPS needs maintenance. In manual bypass mode, the connected critical loads will be supplied by the manual bypass and the output won't be protected. Please ensure that the bypass AC source is normal.
4. In manual bypass mode, the connected critical loads will be supplied by the manual bypass; thus, maintenance personnel can perform maintenance without interrupting the power supplying to the critical loads.
5. Ensure that all of the breakers and switches (except the Delta or non-Delta external maintenance bypass cabinet's manual bypass breaker or switch (Q3)) are in the **OFF** position, and use a voltmeter to check there is no high voltage inside the UPS. Only after confirmation can service personnel perform UPS maintenance.
6. Please note that, during UPS maintenance process, the Delta or non-Delta external maintenance bypass cabinet has high voltage. Do not touch the Delta or non-Delta external maintenance bypass cabinet to avoid electric shock.

- **Switching from online mode to manual bypass mode**

- 1) When the UPS is in online mode, the main screen will appear shown in the figure below. At this time, the tri-color LED indicator will illuminate green. For the position of the tri-color LED indicator, please refer to **Figure 2-11**.

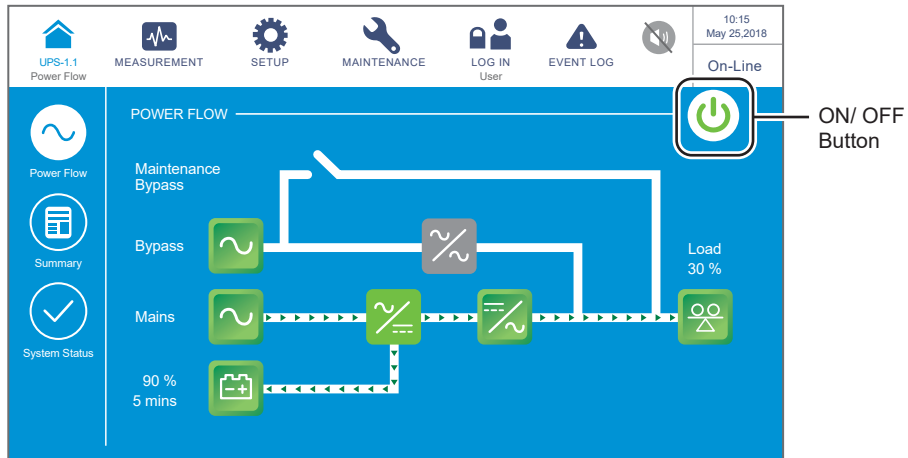

(Figure 6-14: Online Mode Screen_ User Login & ON/ OFF Button Location)

- 2) Press the ON/ OFF button () once and the following screen will pop up to ask you if you want to power off the UPS's inverter.

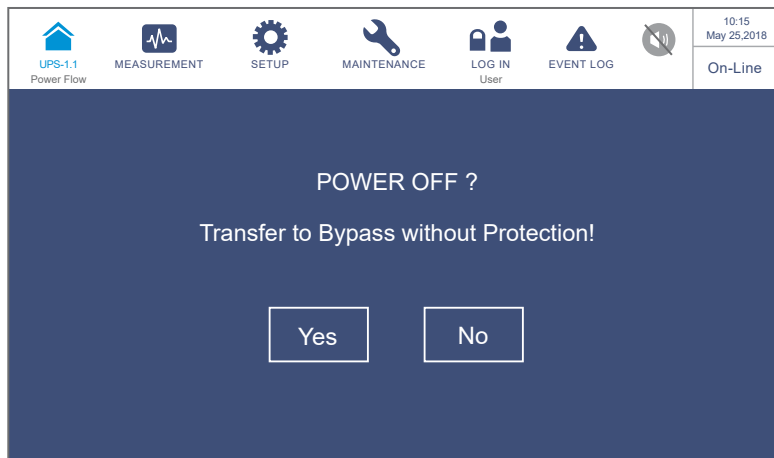

(Figure 6-15: Power Off Reminder Screen)

- 3) Check if the bypass voltage and STS module are normal or not. If normal, please select '**YES**'. After that, the UPS will shut down the inverter and transfer to run in bypass mode.
- 4) Ensure that the UPS runs in bypass mode. After confirmation, turn on the Delta or non-Delta external maintenance bypass cabinet's manual bypass breaker or switch (Q3).

5) **Single Input:**

Switch **OFF** the UPS's bypass switch (Q0), Delta or non-Delta external maintenance bypass cabinet's input breaker or switch (Q1) and output breaker or switch (Q4).

Dual Input:

Switch **OFF** the UPS's bypass switch (Q0), Delta or non-Delta external maintenance bypass cabinet's input breaker or switch (Q1), bypass breaker or switch (Q2) and output breaker or switch (Q4).

After that, the screen shows as follows.

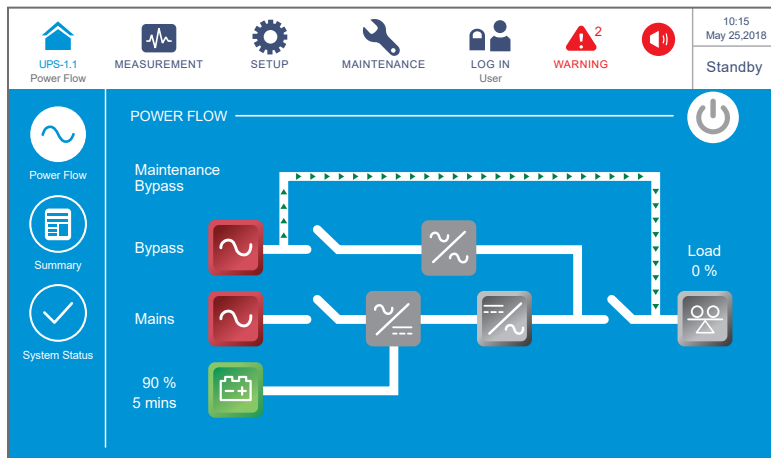

(Figure 6-16 : Manual Bypass Mode Screen)

- 6) When the UPS is discharging DC bus voltage, the LED indicator on each power module will flash green. After discharging is completed, the LED indicator of each power module will be off.
- 7) After three minutes, the UPS will shut down, and the LCD and the tri-color LED indicator will be off.
- 8) Switch **OFF** each external battery cabinet's breaker (Q5).

• **Switching from manual bypass mode to online mode**



WARNING:

1. For parallel units, ensure that every operation procedure mentioned below is synchronized to all parallel UPSs.
2. For parallel application, if you just want to operate a specific UPS but not all parallel ones, please contact service personnel.

- 1) Switch **ON** each external battery cabinet's breaker (Q5).

2) **Single Input:**

Switch **ON** the UPS's bypass switch (Q0), Delta or non-Delta external maintenance bypass cabinet's input breaker or switch (Q1) and output breaker or switch (Q4).

Dual Input:

Switch **ON** the UPS's bypass switch (Q0), Delta or non-Delta external maintenance bypass cabinet's input breaker or switch (Q1), bypass breaker or switch (Q2) and output breaker or switch (Q4).

3) After you switch **ON** the UPS's bypass switch (Q0), Delta or non-Delta external maintenance bypass cabinet's input breaker or switch (Q1) and bypass breaker or switch (Q2), each auxiliary power card's LED indicator will illuminate green and the following status will occur simultaneously.

1. The system and each power module will start initialization. After each power module finishes initialization, each power module's fans will start running, each power module will start establishing DC BUS voltage and each power module's LED indicator will illuminate green.
2. Each parallel communication card's LED indicator will illuminate red first and then each parallel communication card will start initialization. After initialization, the master parallel communication card's LED indicator will illuminate green and the backup communication card's LED indicator will illuminate yellow.

For the locations of parallel communication cards, auxiliary power cards, power modules and associated LED indicators, please refer to **Figure 6-1**.

4) The LCD initial screen (see **Figure 6-17**) will appear within 40 seconds after the UPS's bypass switch (Q0), Delta or non-Delta external maintenance bypass cabinet's input breaker or switch (Q1) and bypass breaker or switch (Q2) are turned on.



(Figure 6-17 : LCD Initial Screen)

- 5 After 20 seconds of LCD initialization, the LCD will enter the **Main Screen**. For the **Main Screen** information, please refer to **7.6 Main Screen**.

Now, each power module keeps running and its LED indicator remains green. After each power module finishes establishing DC BUS voltage, the charger will start to charge the batteries.

If the bypass AC source is within the normal range, the UPS will transfer to run in bypass mode, the LCD screen will show as **Figure 6-18** and the tri-color LED indicator will illuminate yellow. For the location of the tri-color LED indicator, please refer to **Figure 2-11**.

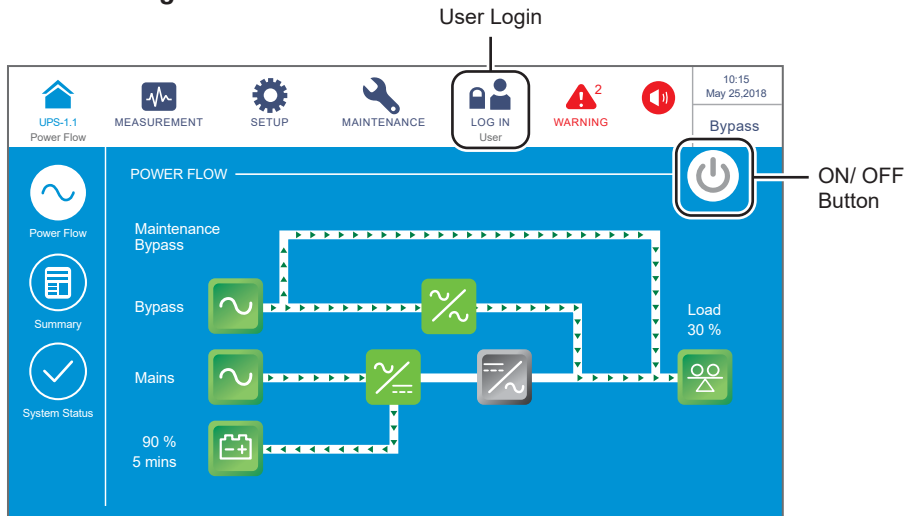

(Figure 6-18 : Manual Bypass Mode Screen_ User Login & ON/ OFF Button Location)

- 6 Switch **OFF** the Delta or non-Delta external maintenance bypass cabinet's manual bypass breaker or switch (Q3).
- 7 Press the ON/ OFF button () once and the following screen will pop up to ask you if you want to power on the UPS's inverter. Please select 'YES'.



(Figure 6-19: Power On Reminder Screen)

- 8) After selection of 'YES' to start up the inverter, each power module will start up and perform self-inspection. At the same time, the system begins synchronization with the bypass AC source. After the self-inspection is completed, the UPS will automatically transfer to run in online mode, the tri-color LED indicator will illuminate green and the following screen will appear. For the tri-color LED indicator location, please refer to **Figure 2-11**.

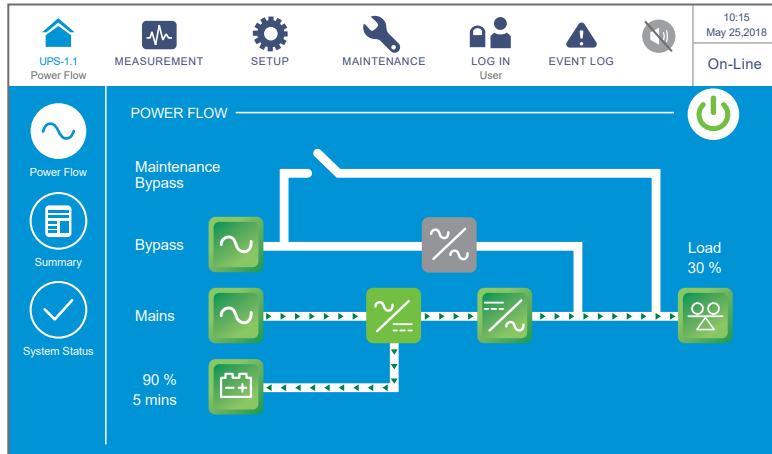

(Figure 6-20: Online Mode Screen)

6.2.5 ECO Mode Start-up Procedures



WARNING:

1. For parallel units, please follow **6.2.3 Bypass Mode Start-up Procedures** to turn on each parallel UPS. After confirming that parallel operation can be normally run, follow the following procedures step by step.
2. For parallel units, ensure that every operation procedure mentioned below is synchronized to all parallel UPSs.
3. For parallel application, if you just want to operate a specific UPS but not all parallel ones, please contact service personnel.

- 1) Ensure that the manual bypass breaker or switch (Q3) of the Delta or non-Delta external maintenance bypass cabinet is in the **OFF** position.

- 2) Switch **ON** each external battery cabinet's breaker (Q5).

- 3) **Single Input:**

Switch **ON** the bypass switch (Q0) of the UPS, the input breaker or switch (Q1) and the output breaker or switch (Q4) of the Delta or non-Delta external maintenance bypass cabinet.

Dual Input:

Switch **ON** the bypass switch (Q0) of the UPS, the input breaker or switch (Q1), the bypass breaker or switch (Q2) and the output breaker or switch (Q4) of the Delta or non-Delta external maintenance bypass cabinet.

- 4 After you switch **ON** the UPS's bypass switch (Q0), Delta or non-Delta external maintenance bypass cabinet's input breaker or switch (Q1) and bypass breaker or switch (Q2), each auxiliary power card's LED indicator will illuminate green and the following status will occur simultaneously.
1. The system and each power module will start initialization. After each power module finishes initialization, each power module's fans will start running, each power module will start establishing DC BUS voltage and each power module's LED indicator will illuminate green.
 2. Each parallel communication card's LED indicator will illuminate red first and then each parallel communication card will start initialization. After initialization, the master parallel communication card's LED indicator will illuminate green and the backup communication card's LED indicator will illuminate yellow.

For the locations of parallel communication cards, auxiliary power cards, power modules and associated LED indicators, please refer to **Figure 6-1**.

- 5 The LCD initial screen (see **Figure 6-21**) will appear within 40 seconds after the UPS's bypass switch (Q0), Delta or non-Delta external maintenance bypass cabinet's input breaker or switch (Q1) and bypass breaker or switch (Q2) are turned on.



(Figure 6-21 : LCD Initial Screen)

- 6 After 20 seconds of LCD initialization, the LCD will enter the **Main Screen**. For the **Main Screen** information, please refer to **7.6 Main Screen**.

Now, each power module keeps running and its LED indicator remains green. After each power module finishes establishing DC BUS voltage, the charger will start to charge the batteries.

If the bypass AC source is within the normal range, the UPS will transfer to run in bypass mode, the LCD screen will show as **Figure 6-22** and the tri-color LED indicator will illuminate yellow. For the location of the tri-color LED indicator, please refer to **Figure 2-11**.

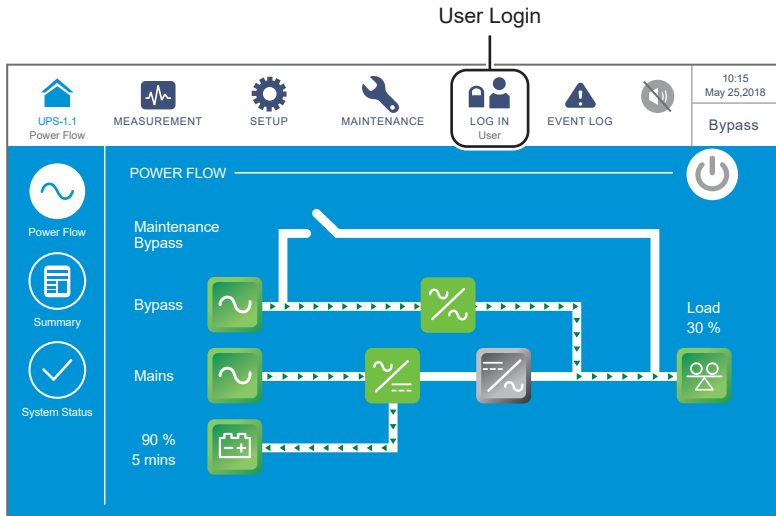

(Figure 6-22 : Main Screen_ User Login)

- 7 Please log in as an **Administrator**. For the **Administrator** password, please contact service personnel. After login, ensure that you are in the **Administrator** login status (see **Figure 6-23**).

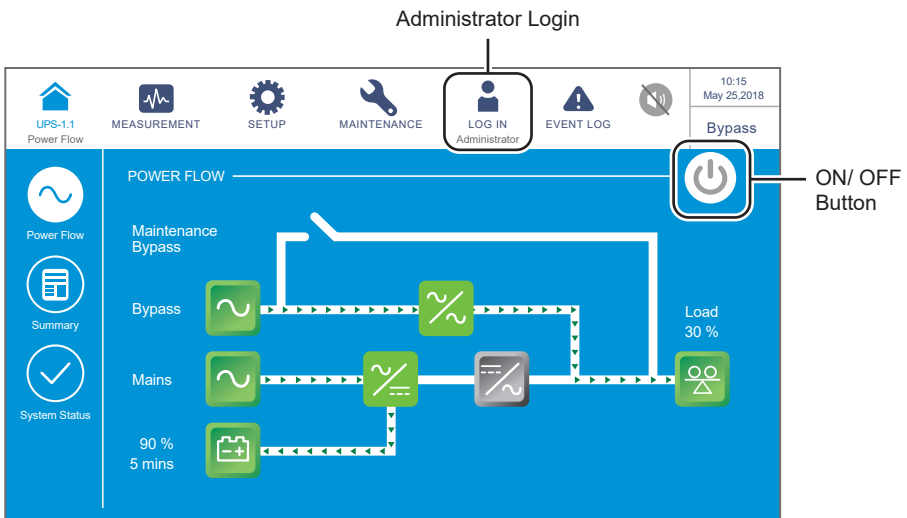

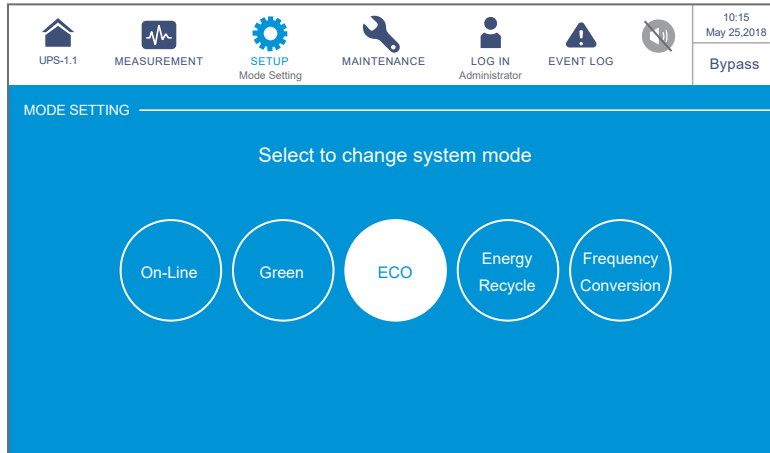

(Figure 6-23 : Main Screen_ Administrator Login & ON/ OFF Button Location)

- 8 Click **SETUP** → **Mode Setting** → **ECO**.



(Figure 6-24: Select ECO Mode)

- 9 After manually selecting **ECO** mode via the LCD, press the icon () located in the upper left corner of the screen to go back to the **Main Screen**.
- 10 Press the ON/ OFF button () once and the following screen will pop up to ask you if you want to power on the UPS's inverter. Please select '**YES**'.

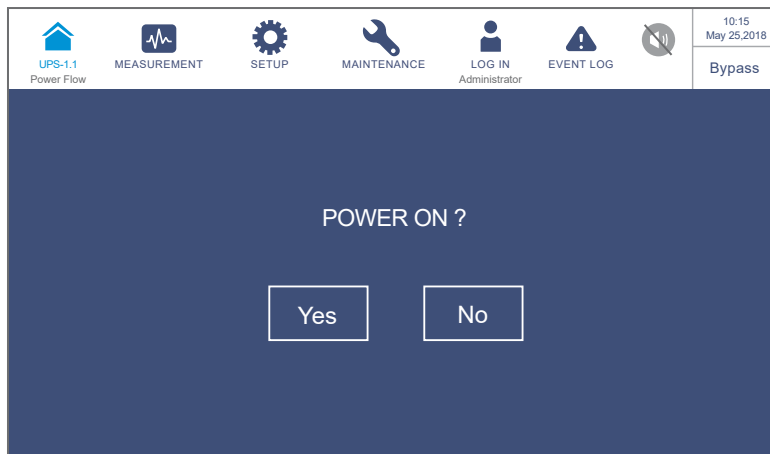

(Figure 6-25: Power On Reminder Screen)

- 11 After selection of '**YES**' to start up the UPS's inverter, each power module will start up and perform self-inspection. At the same time, the system begins synchronization with the bypass AC source. After the self-inspection is completed, the UPS will automatically transfer to run in online mode. After the system confirms that the bypass voltage is normal, the UPS will automatically switch to run in ECO mode to let the bypass AC source supply power (see **Figure 6-26**). Now, the tri-color LED indicator illuminates green and the following screen appears. For the tri-color LED indicator location, please refer to **Figure 2-11**.

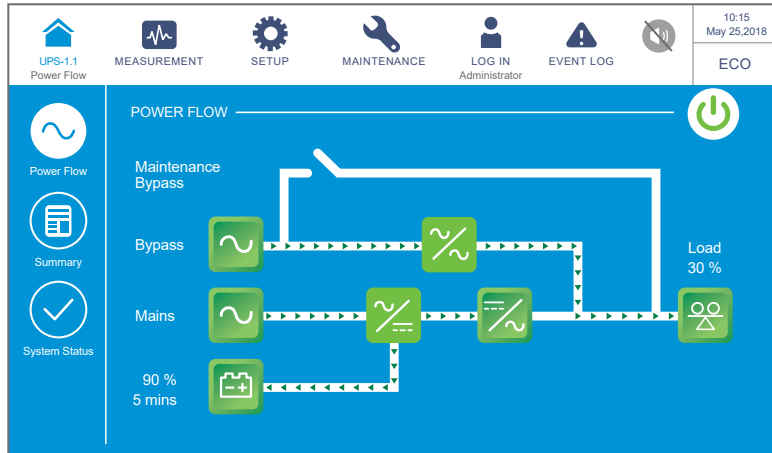

(Figure 6-26: ECO Mode Screen)

6.2.6 Frequency Conversion Mode Start-up Procedures



WARNING:

1. For parallel units, please follow **6.2.3 Bypass Mode Start-up Procedures** to turn on each parallel UPS. After confirming that parallel operation can be normally run, follow the following procedures step by step.
2. For parallel units, ensure that every operation procedure mentioned below is synchronized to all parallel UPSs.
3. For parallel application, if you just want to operate a specific UPS but not all parallel ones, please contact service personnel.

① Ensure that the manual bypass breaker or switch (Q3) of the Delta or non-Delta external maintenance bypass cabinet is in the **OFF** position.

② Switch **ON** each external battery cabinet's breaker (Q5).

③ **Single Input:**

Switch **ON** the bypass switch (Q0) of the UPS, the input breaker or switch (Q1) and the output breaker or switch (Q4) of the Delta or non-Delta external maintenance bypass cabinet.

Dual Input:

Switch **ON** the bypass switch (Q0) of the UPS, the input breaker or switch (Q1), the bypass breaker or switch (Q2) and the output breaker or switch (Q4) of the Delta or non-Delta external maintenance bypass cabinet.

④ After you switch **ON** the UPS's bypass switch (Q0), Delta or non-Delta external maintenance bypass cabinet's input breaker or switch (Q1) and bypass breaker or switch (Q2), each auxiliary power card's LED indicator will illuminate green and the following status will occur simultaneously.

1. The system and each power module will start initialization. After each power module finishes initialization, each power module's fans will start running, each power module will start establishing DC BUS voltage and each power module's LED indicator will illuminate green.
2. Each parallel communication card's LED indicator will illuminate red first and then each parallel communication card will start initialization. After initialization, the master parallel communication card's LED indicator will illuminate green and the backup communication card's LED indicator will illuminate yellow.

For the locations of parallel communication cards, auxiliary power cards, power modules and associated LED indicators, please refer to **Figure 6-1**.

- 5) The LCD initial screen (see **Figure 6-27**) will appear within 40 seconds after the UPS's bypass switch (Q0), Delta or non-Delta external maintenance bypass cabinet's input breaker or switch (Q1) and bypass breaker or switch (Q2) are turned on.



(Figure 6-27 : LCD Initial Screen)

- 6) After 20 seconds of LCD initialization, the LCD will enter the **Main Screen**. For the **Main Screen** information, please refer to **7.6 Main Screen**.

Now, each power module keeps running and its LED indicator remains green. After each power module finishes establishing DC BUS voltage, the charger will start to charge the batteries.

If the bypass AC source is within the normal range, the UPS will transfer to run in bypass mode, the LCD screen will show as **Figure 6-28** and the tri-color LED indicator will illuminate yellow. For the location of the tri-color LED indicator, please refer to **Figure 2-11**.

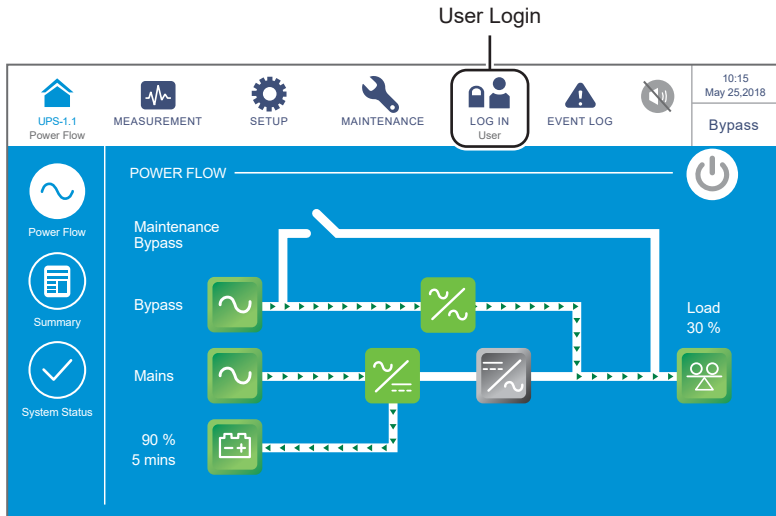

(Figure 6-28 : Main Screen_ User Login)

- 7 Please log in as an **Administrator**. For the **Administrator** password, please contact service personnel. After login, ensure that you are in the **Administrator** login status (see **Figure 6-29**).

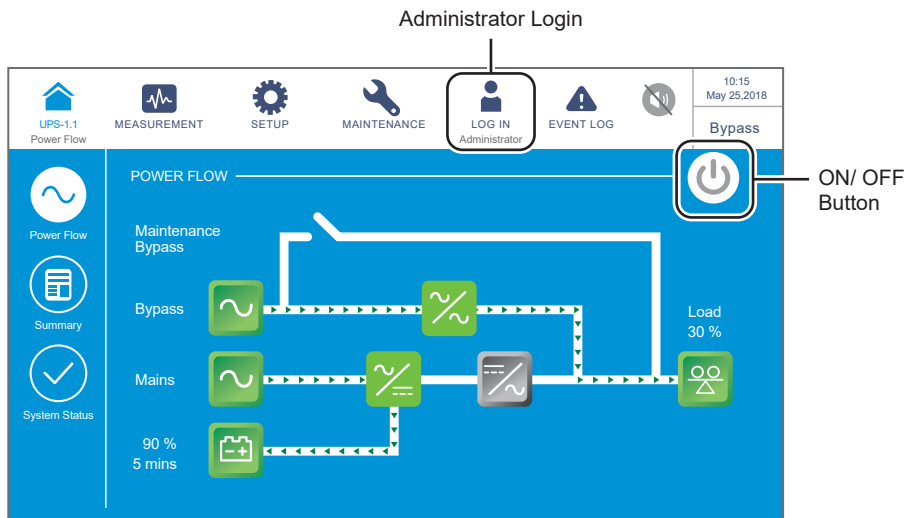

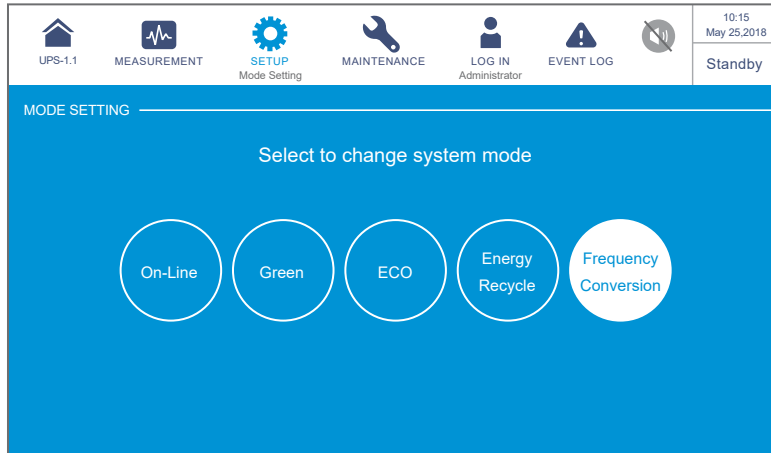

(Figure 6-29 : Main Screen_ Administrator Login & ON/ OFF Button Location)

- 8 Click **SETUP** → **Mode Setting** → **Frequency Conversion**.



(Figure 6-30: Select Frequency Conversion Mode)

- 9) After manually selecting **Frequency Conversion** mode via the LCD, the UPS will run in standby mode and the output will be terminated.
- 10) Press the icon () located in the upper left corner of the screen to go back to the **Main Screen**.
- 11) Press the ON/ OFF button () once and the following screen will pop up to ask you if you want to power on the UPS's inverter. Please select '**YES**'.

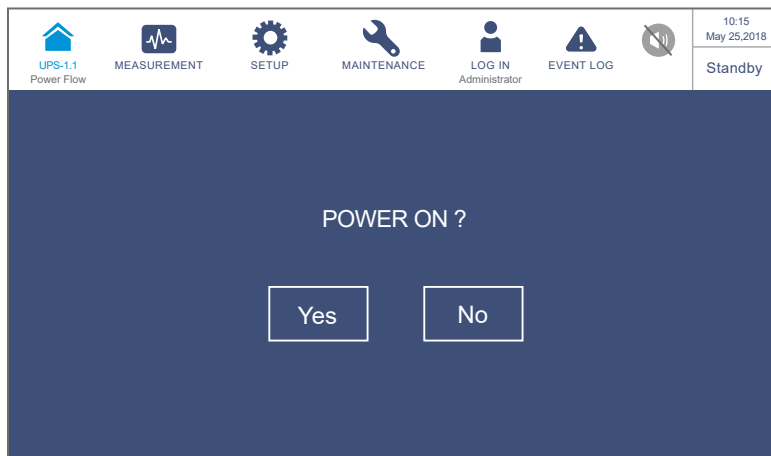

(Figure 6-31: Power On Reminder Screen)

- 12) After selection of '**YES**' to start up the UPS's inverter, each power module will start up and perform self-inspection.

After the self-inspection is completed, the UPS will automatically transfer to run in frequency conversion mode and the output frequency will be the same as setup value. Now, the tri-color LED indicator illuminates green and the following screen appears. For the tri-color LED indicator location, please refer to **Figure 2-11**.

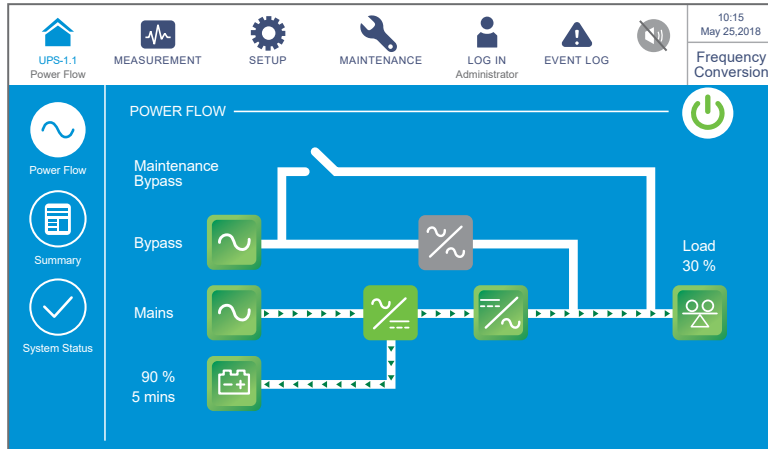

(Figure 6-32: Frequency Conversion Mode)

6.2.7 Green Mode Start-up Procedures



WARNING:

1. For parallel units, please follow **6.2.3 Bypass Mode Start-up Procedures** to turn on each parallel UPS. After confirming that parallel operation can be normally run, follow the following procedures step by step.
2. For parallel units, ensure that every operation procedure mentioned below is synchronized to all parallel UPSs.
3. For parallel application, if you just want to operate a specific UPS but not all parallel ones, please contact service personnel.

① Ensure that the manual bypass breaker or switch (Q3) of the Delta or non-Delta external maintenance bypass cabinet is in the **OFF** position.

② Switch **ON** each external battery cabinet's breaker (Q5).

③ **Single Input:**

Switch **ON** the bypass switch (Q0) of the UPS, the input breaker or switch (Q1) and the output breaker or switch (Q4) of the Delta or non-Delta external maintenance bypass cabinet.

Dual Input:

Switch **ON** the bypass switch (Q0) of the UPS, the input breaker or switch (Q1), the bypass breaker or switch (Q2) and the output breaker or switch (Q4) of the Delta or non-Delta external maintenance bypass cabinet.

④ After you switch **ON** the UPS's bypass switch (Q0), Delta or non-Delta external maintenance bypass cabinet's input breaker or switch (Q1) and bypass breaker or switch (Q2), each auxiliary power card's LED indicator will illuminate green and the following status will occur simultaneously.

1. The system and each power module will start initialization. After each power module finishes initialization, each power module's fans will start running, each power module will start establishing DC BUS voltage and each power module's LED indicator will illuminate green.
2. Each parallel communication card's LED indicator will illuminate red first and then each parallel communication card will start initialization. After initialization, the master parallel communication card's LED indicator will illuminate green and the backup communication card's LED indicator will illuminate yellow.

For the locations of parallel communication cards, auxiliary power cards, power modules and associated LED indicators, please refer to **Figure 6-1**.

- 5) The LCD initial screen (see **Figure 6-33**) will appear within 40 seconds after the UPS's bypass switch (Q0), Delta or non-Delta external maintenance bypass cabinet's input breaker or switch (Q1) and bypass breaker or switch (Q2) are turned on.



(Figure 6-33 : LCD Initial Screen)

- 6) After 20 seconds of LCD initialization, the LCD will enter the **Main Screen**. For the **Main Screen** information, please refer to **7.6 Main Screen**.

Now, each power module keeps running and its LED indicator remains green. After each power module finishes establishing DC BUS voltage, the charger will start to charge the batteries.

If the bypass AC source is within the normal range, the UPS will transfer to run in bypass mode, the LCD screen will show as **Figure 6-34** and the tri-color LED indicator will illuminate yellow. For the location of the tri-color LED indicator, please refer to **Figure 2-11**.

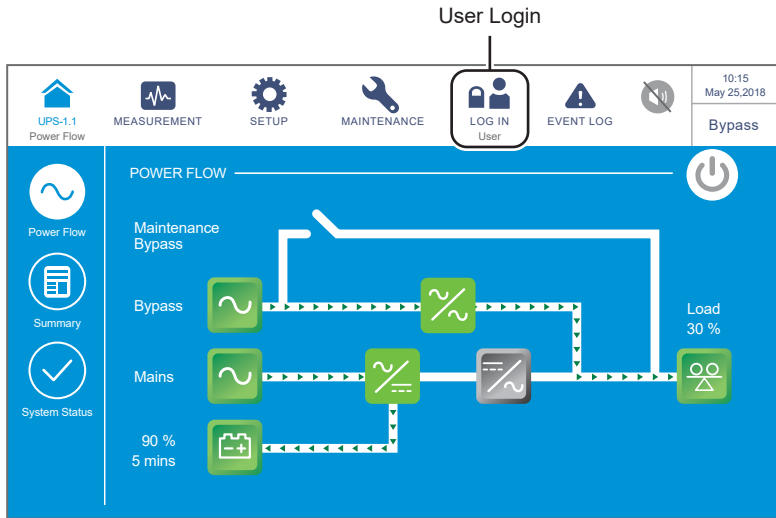

(Figure 6-34 : Main Screen_ User Login)

- 7 Please log in as an **Administrator**. For the **Administrator** password, please contact service personnel. After login, ensure that you are in the **Administrator** login status (see **Figure 6-35**).

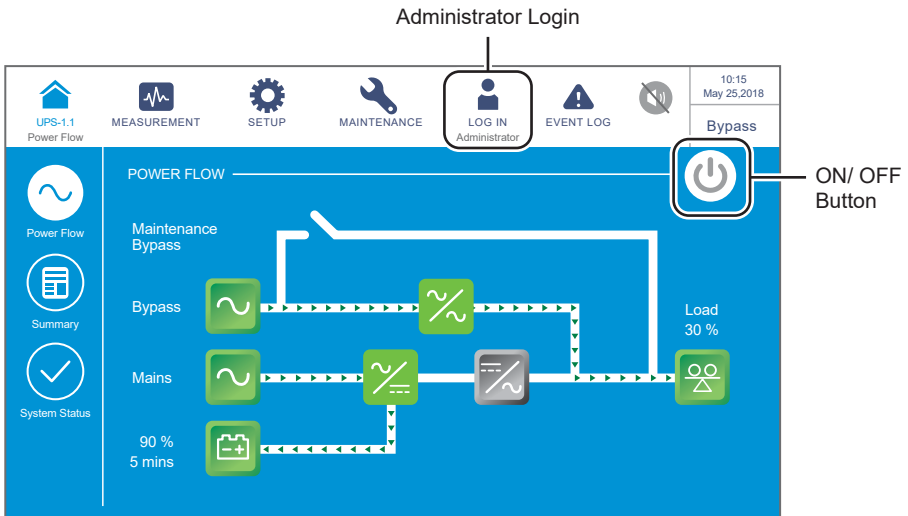

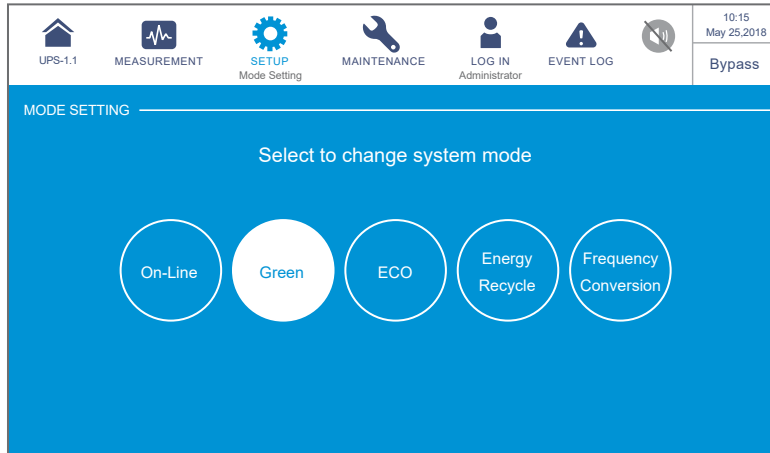

(Figure 6-35 : Main Screen_ Administrator Login & ON/ OFF Button Location)

- 8 Click **SETUP** → **Mode Setting** → **Green**.



(Figure 6-36: Select Green Mode)

- 9 After manually selecting **Green** mode via the LCD, press the icon () located in the upper left corner of the screen to go back to the **Main Screen**.
- 10 Press the ON/ OFF button () once and the following screen will pop up to ask you if you want to power on the UPS's inverter. Please select '**YES**'.

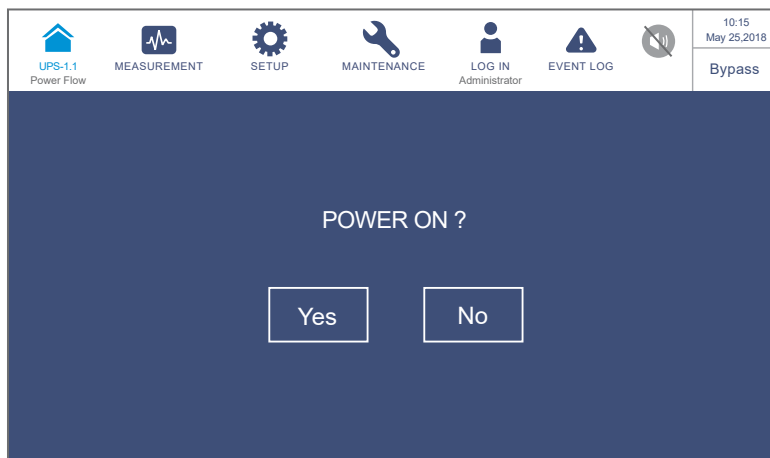

(Figure 6-37: Power On Reminder Screen)

- 11 After selection of '**YES**' to start up the UPS's inverter, each power module will start up and perform self-inspection. At the same time, the system begins synchronization with the bypass AC source. After the self-inspection is completed, the UPS will automatically transfer to run in green mode and the system will automatically detect the output status (i.e. total load capacity %) to decide which specific power modules should be fully powered on or idle in order to achieve higher efficiency of the UPS. Now, the tri-color LED indicator illuminates green and the following screen appears. For the tri-color LED indicator location, please refer to **Figure 2-11**.

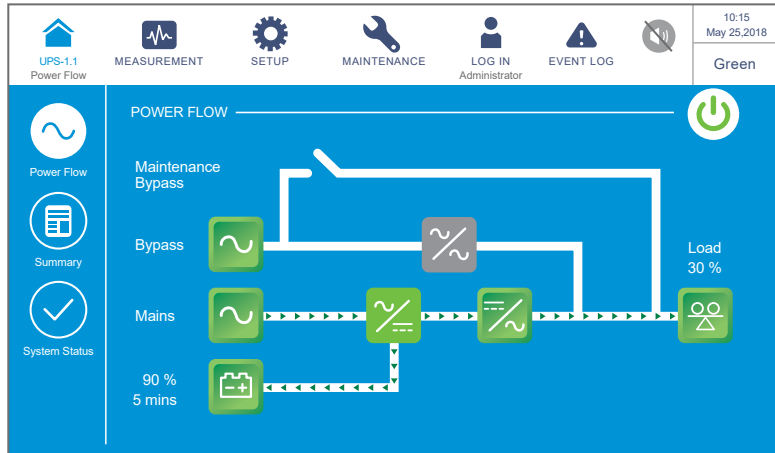

(Figure 6-38: Green Mode Screen)

6.2.8 Energy Recycle Mode Start-up Procedures



WARNING: Energy recycle mode is only applicable to single input and single unit application.

- 1 Ensure that the Delta or non-Delta external maintenance bypass cabinet's manual bypass breaker or switch (Q3), output breaker or switch (Q4) and every external battery cabinet's breaker (Q5) are in the **OFF** position.
- 2 Switch **ON** the bypass switch (Q0) of the UPS and the input breaker or switch (Q1) of the Delta or non-Delta external maintenance bypass cabinet.
- 3 After you switch **ON** the UPS's bypass switch (Q0) and the Delta or non-Delta external maintenance bypass cabinet's input breaker or switch (Q1), each auxiliary power card's LED indicator will illuminate green and the following status will occur simultaneously.
 1. The system and each power module will start initialization. After each power module finishes initialization, each power module's fans will start running, each power module will start establishing DC BUS voltage and each power module's LED indicator will illuminate green.
 2. Each parallel communication card's LED indicator will illuminate red first and then each parallel communication card will start initialization. After initialization, the master parallel communication card's LED indicator will illuminate green and the backup communication card's LED indicator will illuminate yellow.

For the locations of parallel communication cards, auxiliary power cards, power modules and associated LED indicators, please refer to **Figure 6-1**.

- 4 The LCD initial screen (see **Figure 6-39**) will appear within 40 seconds after the UPS's bypass switch (Q0) and the Delta or non-Delta external maintenance bypass cabinet's input breaker or switch (Q1) are turned on.



(Figure 6-39 : LCD Initial Screen)

- 5 After 20 seconds of LCD initialization, the LCD will enter the **Main Screen**. For the **Main Screen** information, please refer to **7.6 Main Screen**.

Now, each power module keeps running and its LED indicator remains green. After each power module finishes establishing DC BUS voltage, the charger will start to charge the batteries.

If the bypass AC source is within the normal range, the UPS will transfer to run in bypass mode, the LCD screen will show as **Figure 6-40** and the tri-color LED indicator will illuminate yellow. For the location of the tri-color LED indicator, please refer to **Figure 2-11**.

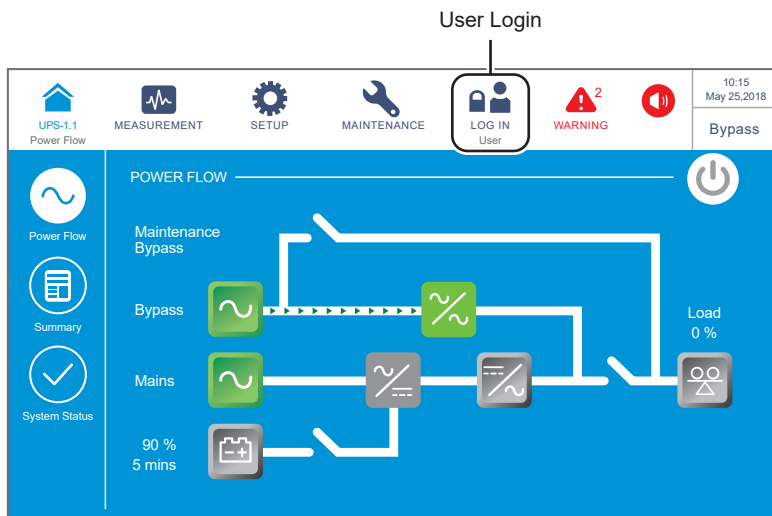

(Figure 6-40: Main Screen_ User Login)

- 6 Please log in as an **Administrator**. For the **Administrator** password, please contact service personnel. After login, ensure that you are in the **Administrator** login status (see **Figure 6-41**).

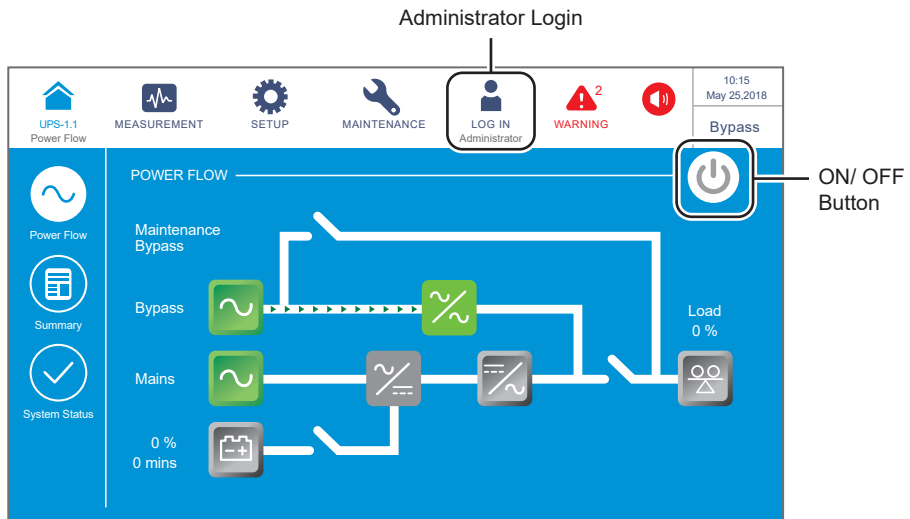

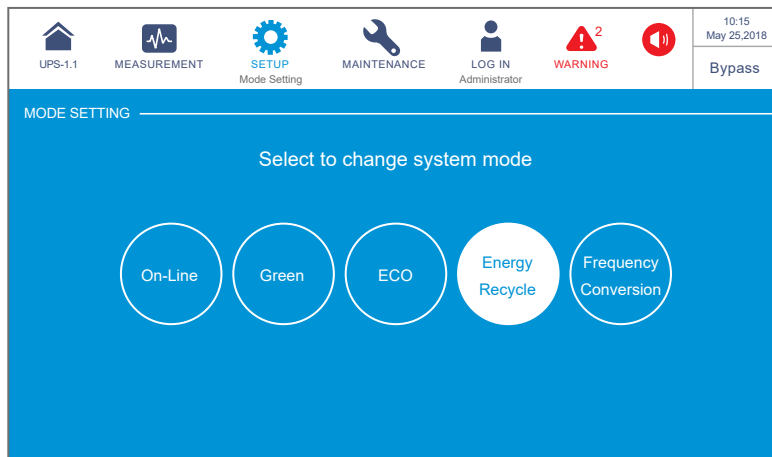

(Figure 6-41 : Main Screen_ Administrator Login & ON/ OFF Button Location)

- 7 Click **SETUP** → **Mode Setting** → **Energy Recycle**.



(Figure 6-42: Select Energy Recycle Mode)

- 8 After manually selecting **Energy Recycle** mode via the LCD, press the icon () located in the upper left corner of the screen to go back to the **Main Screen**.
- 9 Press the ON/ OFF button () once and the following screen will pop up to ask you if you want to power on the UPS's inverter. Please select '**YES**'.

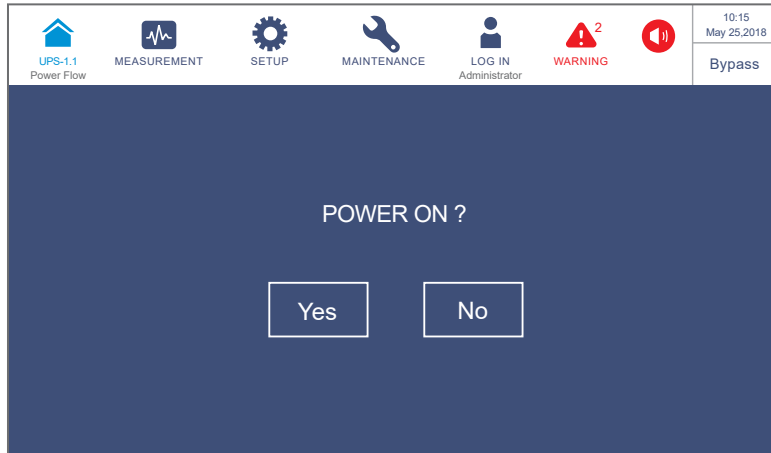

(Figure 6-43: Power On Reminder Screen)

- 10 After selection of 'YES' to start up the UPS's inverter, each power module will start up and perform self-inspection. At the same time, the system begins synchronization with the bypass AC source. After the self-inspection is completed, the UPS will automatically transfer to run in energy recycle mode and perform self-aging test. Now, the tri-color LED indicator illuminates yellow and the following screen appears. For the tri-color LED indicator location, please refer to **Figure 2-11**.

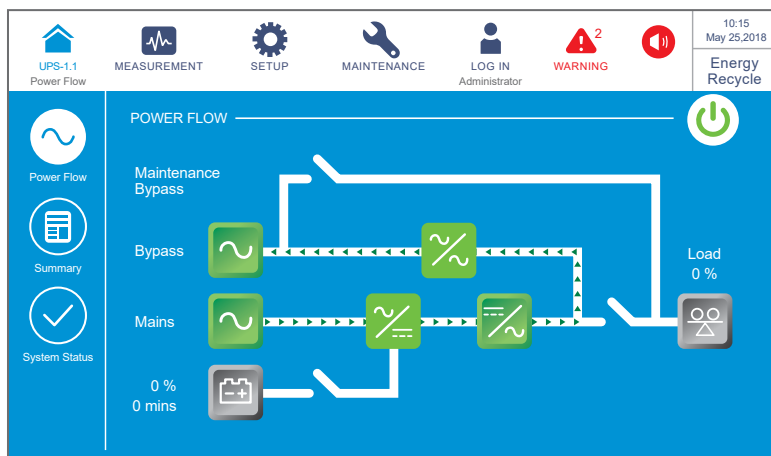

(Figure 6-44: Energy Recycle Mode Screen)

6.3 Turn-off Procedures

6.3.1 Online Mode Turn-off Procedures



WARNING:

1. For parallel units, ensure that every operation procedure mentioned below is synchronized to all parallel UPSs.
2. For parallel application, if you just want to operate a specific UPS but not all parallel ones, please contact service personnel.

- 1 In online mode, the LCD shows the following screen (**Figure 6-45**) and the tri-color LED indicator illuminates green. For the tri-color LED indicator location, please refer to **Figure 2-11**.

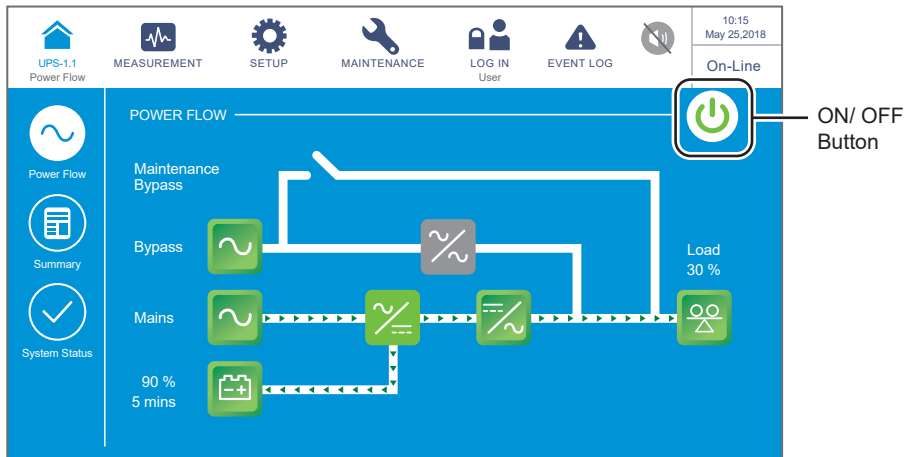

(Figure 6-45: Online Mode Screen_ User Login & ON/ OFF Button Location)

- 2 Press the ON/ OFF button () once and the following screen will pop up to ask you if you want to power off the UPS's inverter. Please select 'YES'.

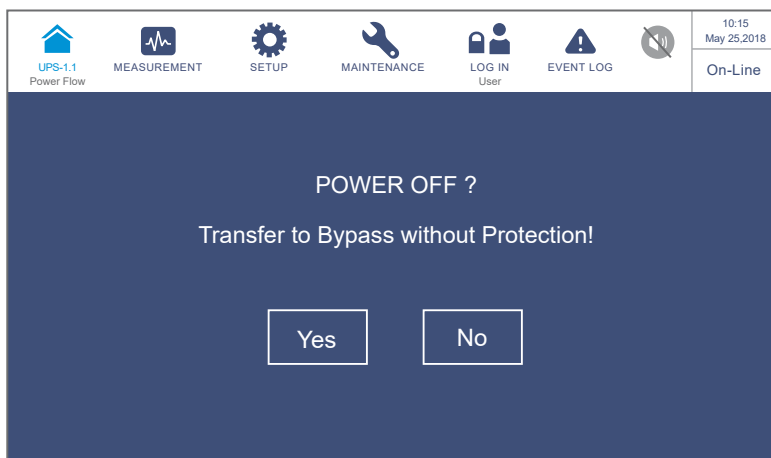

(Figure 6-46: Power Off Reminder Screen)

- 3 After selection of 'YES', the UPS will shut down the inverter, terminate each power module's output and let the bypass AC source supply power. If the bypass AC source is abnormal, there is a risk of output interruption and the connected critical loads won't be protected. At this moment, each power module keeps charging the batteries, the tri-color LED indicator illuminates yellow and the following screen appears (**Figure 6-47**). For the tricolor LED indicator location, please refer to **Figure 2-11**.

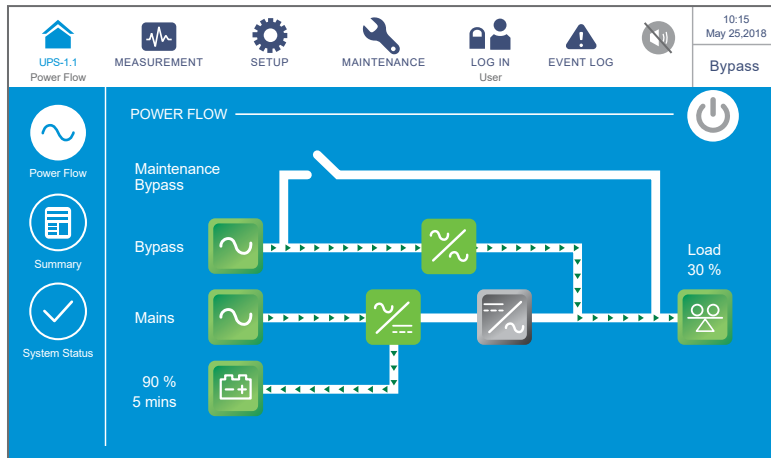

(Figure 6-47: Bypass Mode Screen)

- 4 **Single Input:**
Switch **OFF** the UPS's bypass switch (Q0), Delta or non-Delta external maintenance bypass cabinet's input breaker or switch (Q1) and output breaker or switch (Q4).
- Dual Input:**
Switch **OFF** the UPS's bypass switch (Q0), Delta or non-Delta external maintenance bypass cabinet's input breaker or switch (Q1), bypass breaker or switch (Q2) and output breaker or switch (Q4).
- 5 Now, each power module performs DC BUS discharging and its LED indicator flashes green. After discharging, each power module's LED indicator will be off.
- 6 About 3 minutes later, the UPS will shut down. After that, the LCD and the tricolor LED indicator will be off.
- 7 Switch **OFF** every external battery cabinet's breaker (Q5).

6.3.2 Battery Mode Turn-off Procedures



WARNING:

1. For parallel units, ensure that every operation procedure mentioned below is synchronized to all parallel UPSs.
2. For parallel application, if you just want to operate a specific UPS but not all parallel ones, please contact service personnel.

- 1 In battery mode, the LCD shows the following screen (**Figure 6-48**) and the tri-color LED indicator illuminates yellow. For the tri-color LED indicator location, please refer to **Figure 2-11**.

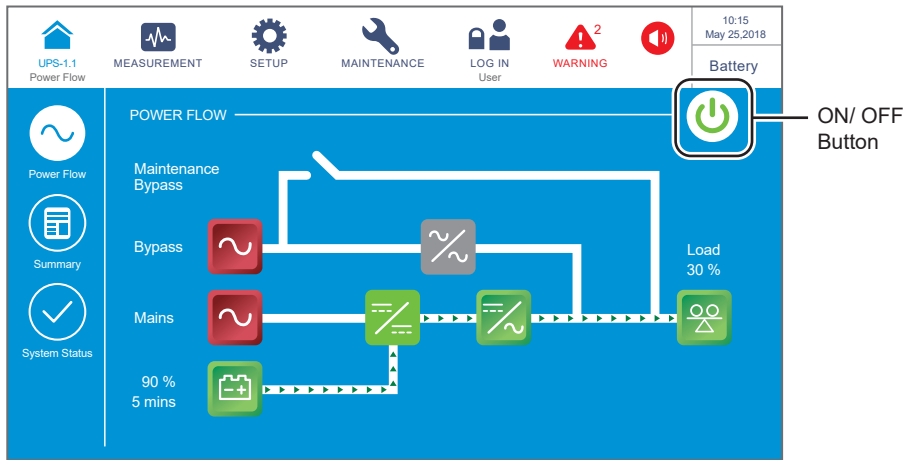

(Figure 6-48: Battery Mode Screen & ON/ OFF Button Location)

- 2 Press the ON/ OFF button () once and the following screen will pop up to ask you if you want to power off the UPS's inverter. Please select 'YES'.

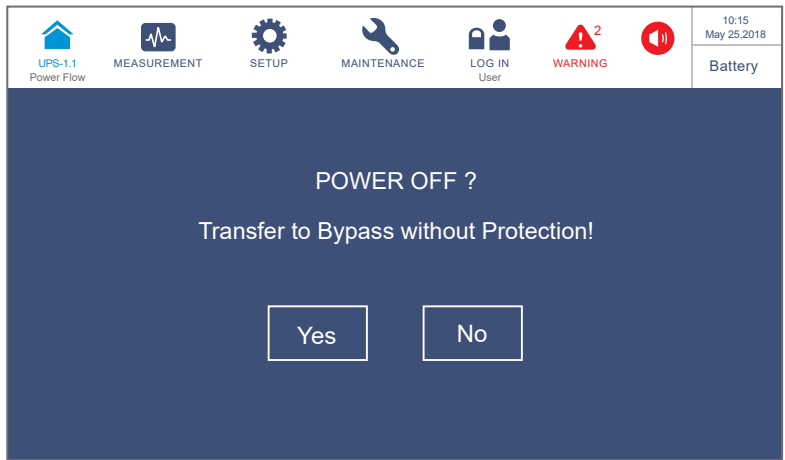

(Figure 6-49: Power Off Reminder Screen)

- 3 After selection of 'YES', the UPS will shut down the inverter, terminate each power module's output and transfer to run in standby mode. At this moment, the tri-color LED indicator illuminates yellow and the following screen appears (**Figure 6-50**). For the tri-color LED indicator location, please refer to **Figure 2-11**.

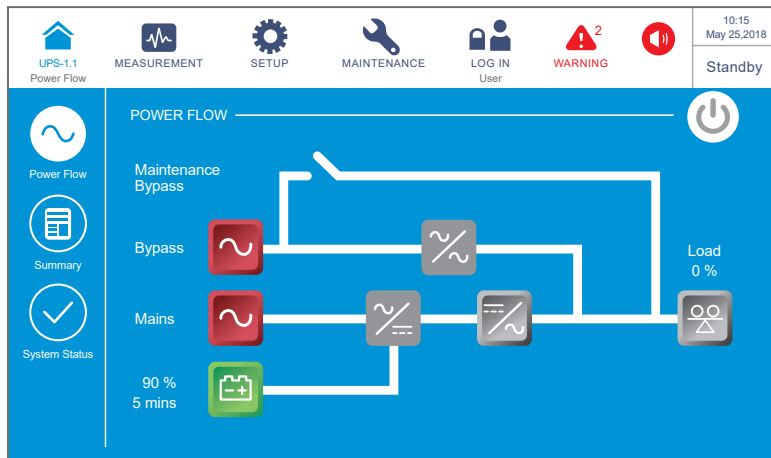

(Figure 6-50: Standby Mode Screen)

- 4 **Single Input:**
Switch **OFF** the UPS's bypass switch (Q0), Delta or non-Delta external maintenance bypass cabinet's input breaker or switch (Q1) and output breaker or switch (Q4).
- Dual Input:**
Switch **OFF** the UPS's bypass switch (Q0), Delta or non-Delta external maintenance bypass cabinet's input breaker or switch (Q1), bypass breaker or switch (Q2) and output breaker or switch (Q4).
- 5 Now, each power module performs DC BUS discharging and its LED indicator flashes green. After discharging, each power module's LED indicator will be off.
- 6 About 3 minutes later, the UPS will shut down. After that, the LCD and the tricolor LED indicator will be off.
- 7 Switch **OFF** every external battery cabinet's breaker (Q5).

6.3.3 Bypass Mode Turn-off Procedures



WARNING:

1. For parallel units, ensure that every operation procedure mentioned below is synchronized to all parallel UPSs.
2. For parallel application, if you just want to operate a specific UPS but not all parallel ones, please contact service personnel.

- 1 In bypass mode, the LCD shows the following screen (**Figure 6-51**) and the tri-color LED indicator illuminates yellow. For the tri-color LED indicator location, please refer to **Figure 2-11**.

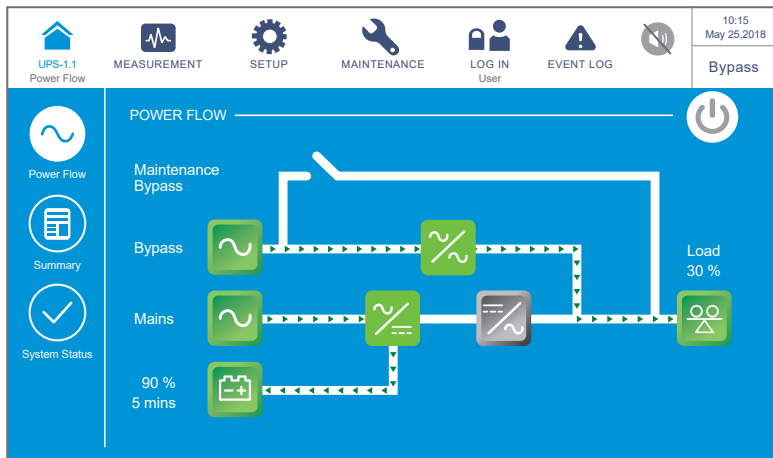

(Figure 6-51: Bypass Mode Screen)

- 2 **Single Input:**
Switch **OFF** the UPS's bypass switch (Q0), Delta or non-Delta external maintenance bypass cabinet's input breaker or switch (Q1) and output breaker or switch (Q4).
Dual Input:
Switch **OFF** the UPS's bypass switch (Q0), Delta or non-Delta external maintenance bypass cabinet's input breaker or switch (Q1), bypass breaker or switch (Q2) and output breaker or switch (Q4).
- 3 Now, each power module performs DC BUS discharging and its LED indicator flashes green. After discharging, each power module's LED indicator will be off.
- 4 About 3 minutes later, the UPS will shut down. After that, the LCD and the tricolor LED indicator will be off.
- 5 Switch **OFF** every external battery cabinet's breaker (Q5).

6.3.4 Manual Bypass Mode Turn-off Procedures



WARNING:

1. For parallel units, ensure that every operation procedure mentioned below is synchronized to all parallel UPSs.
2. For parallel application, if you just want to operate a specific UPS but not all parallel ones, please contact service personnel.

In manual bypass mode, the LCD and the tri-color LED indicator are both **OFF**. In either single input or dual input, please directly switch **OFF** the manual bypass breaker or switch (Q3) of the Delta or non-Delta external maintenance bypass cabinet to completely shut down the UPS.



NOTE:

1. Please make sure that the LCD, all LED indicators and fans are **OFF**.
2. Please make sure that all switches, breakers, and power are **OFF**.

6.3.5 ECO Mode Turn-off Procedures



WARNING:

1. For parallel units, ensure that every operation procedure mentioned below is synchronized to all parallel UPSs.
2. For parallel application, if you just want to operate a specific UPS but not all parallel ones, please contact service personnel.

1 In ECO mode, the LCD shows the following screen (**Figure 6-52**) and the tri-color LED indicator illuminates green. For the tri-color LED indicator location, please refer to **Figure 2-11**.

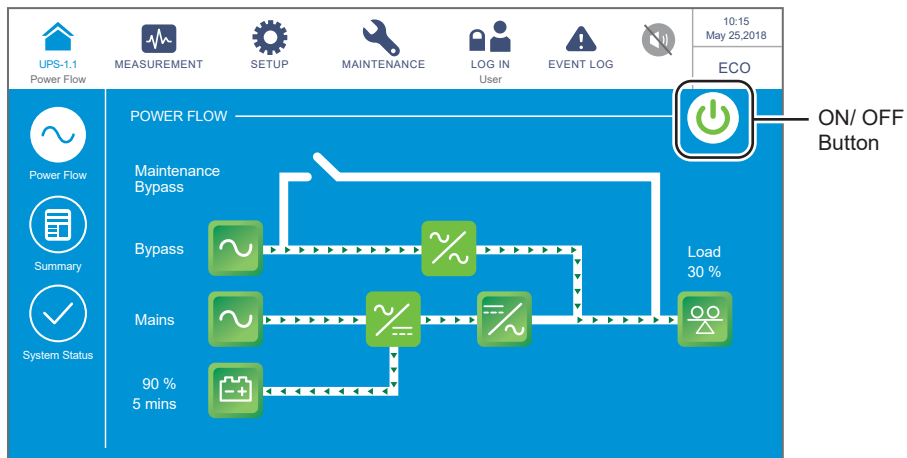

(Figure 6-52: ECO Mode Screen & ON/ OFF Button Location)

- 2 Press the ON/ OFF button () once and the following screen will pop up to ask you if you want to power off the UPS's inverter. Please select 'YES'.

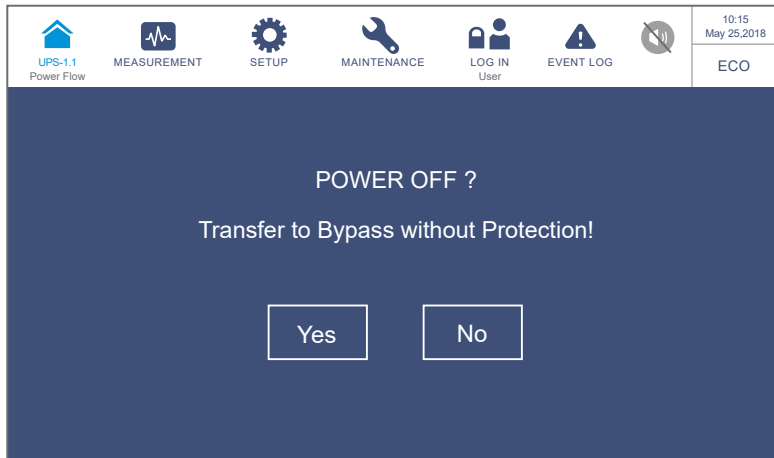

(Figure 6-53: Power Off Reminder Screen)

- 3 After selection of 'YES', the UPS will shut down the inverter, terminate each power module's output and let the bypass AC source supply power. If the bypass AC source is abnormal, there is a risk of output interruption and the connected critical loads won't be protected. At this moment, each power module keeps charging the batteries, the tri-color LED indicator illuminates yellow and the following screen appears (Figure 6-54). For the tri-color LED indicator location, please refer to Figure 2-11.

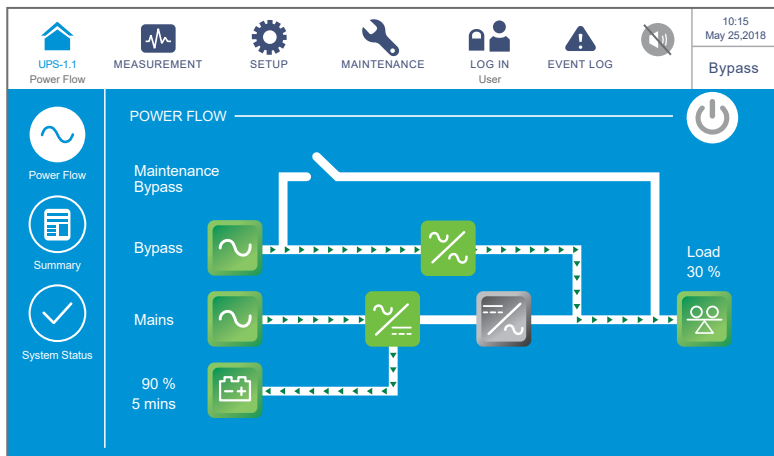

(Figure 6-54: Bypass Mode Screen)

- 4 Please log in as an **Administrator**. For the **Administrator** password, please contact service personnel. After login, ensure that you are in the **Administrator** login status (see Figure 6-55).

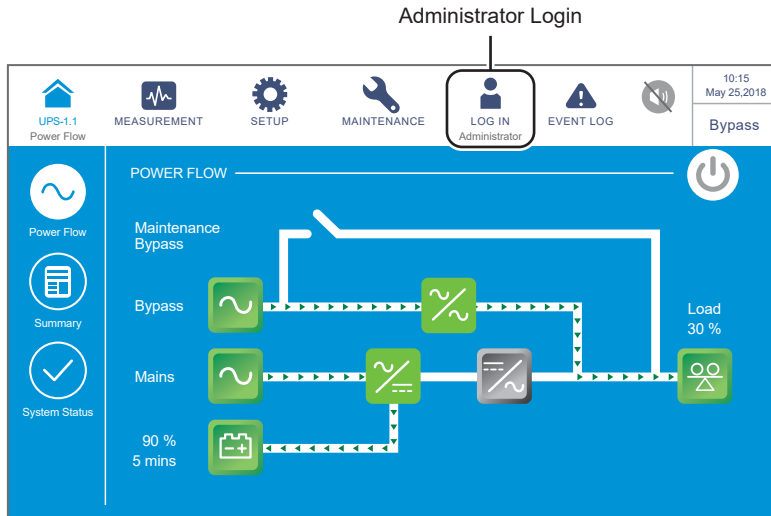

(Figure 6-55 : Bypass Mode Screen_ Administrator Login)

- 5 Click **SETUP** → **Mode Setting** → **On-Line**.

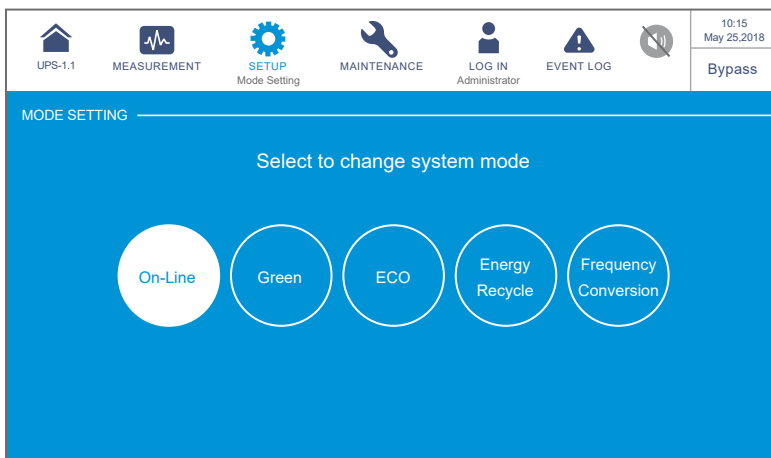

(Figure 6-56 : Select On-Line Mode)

- 6 **Single Input:**

Switch **OFF** the UPS's bypass switch (Q0), Delta or non-Delta external maintenance bypass cabinet's input breaker or switch (Q1) and output breaker or switch (Q4).

Dual Input:

Switch **OFF** the UPS's bypass switch (Q0), Delta or non-Delta external maintenance bypass cabinet's input breaker or switch (Q1), bypass breaker or switch (Q2) and output breaker or switch (Q4).

- 7) Now, each power module performs DC BUS discharging and its LED indicator flashes green. After discharging, each power module's LED indicator will be off.
- 8) About 3 minutes later, the UPS will shut down. After that, the LCD and the tricolor LED indicator will be off.
- 9) Switch **OFF** every external battery cabinet's breaker (Q5).

6.3.6 Frequency Conversion Mode Turn-off Procedures



WARNING:

1. For parallel units, ensure that every operation procedure mentioned below is synchronized to all parallel UPSs.
2. For parallel application, if you just want to operate a specific UPS but not all parallel ones, please contact service personnel.

- 1) In frequency conversion mode, the LCD shows the following screen (**Figure 6-57**) and the tri-color LED indicator illuminates green. For the tri-color LED indicator location, please refer to **Figure 2-11**.

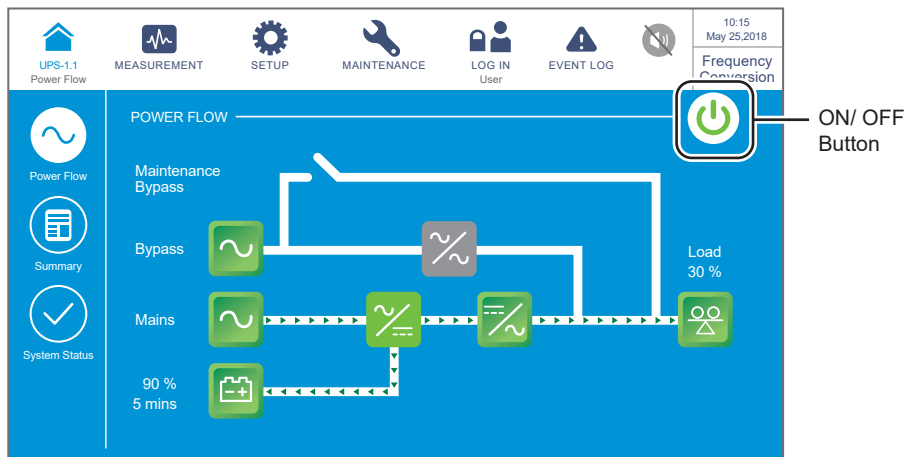

(Figure 6-57: Frequency Conversion Mode Screen & ON/ OFF Button Location)

- 2) Press the ON/ OFF button () once and the following screen will pop up to ask you if you want to power off the UPS's inverter. Please select '**YES**'.



WARNING:

Please note that, once you select '**YES**', all power will be completely cut off. Please make sure that the critical loads connected to the UPS have already been safely shut down before you perform the turn-off procedures.

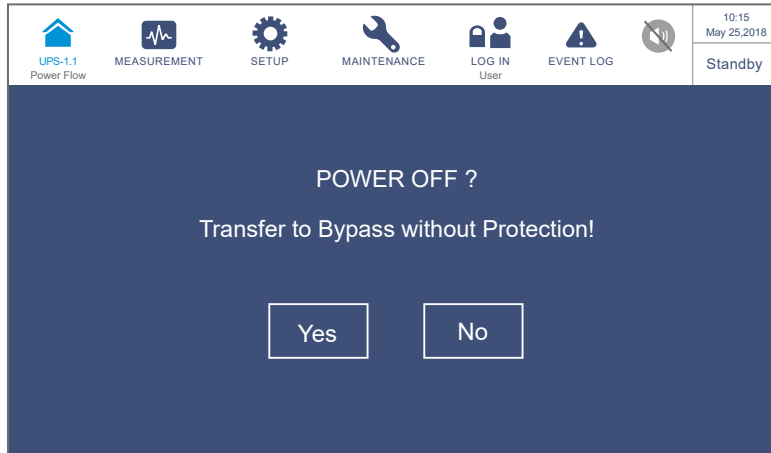

(Figure 6-58: Power Off Reminder Screen)

- 3 After selection of 'YES', the UPS will shut down the inverter and terminate each power module's output. As there is no bypass output in frequency conversion mode, all output will be terminated right after the inverter is shut down. Now, each power module keeps charging the batteries, the tri-color LED indicator illuminates yellow and the following screen appears (Figure 6-59). For the tri-color LED indicator location, please refer to Figure 2-11.

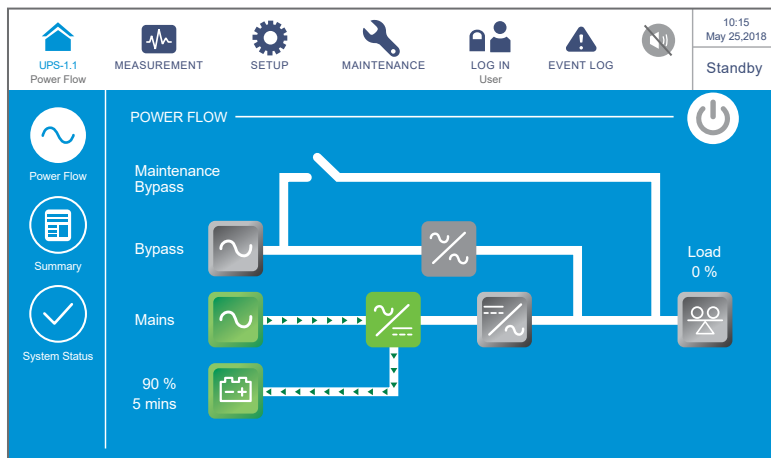

(Figure 6-59: Standby Mode Screen)

- 4 Switch **OFF** the Delta or non-Delta external maintenance bypass cabinet's output breaker or switch (Q4) and log in as an **Administrator**. For the **Administrator** password, please contact service personnel. After login, ensure that you are in the **Administrator** login status (see Figure 6-60).

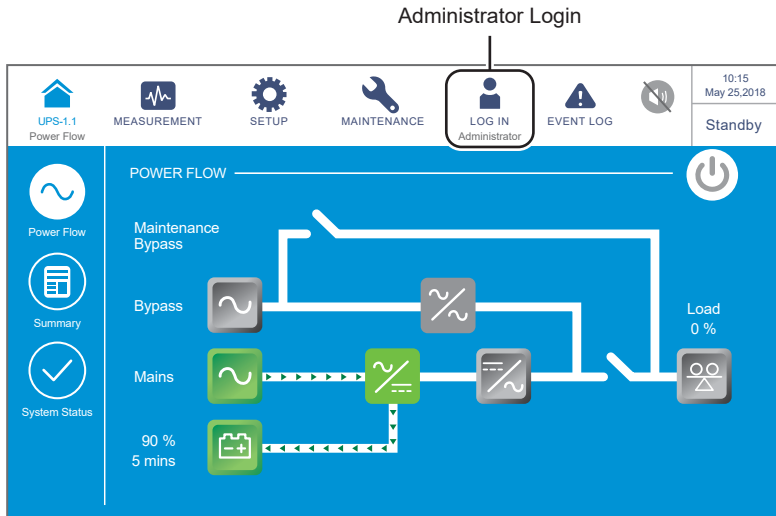

(Figure 6-60 : Standby Mode Screen_ Administrator Login)

- 5 Click **SETUP** → **Mode Setting** → **On-Line**. If the bypass voltage is in the normal range, the UPS will run in bypass mode to let the bypass AC source supply power to the output.

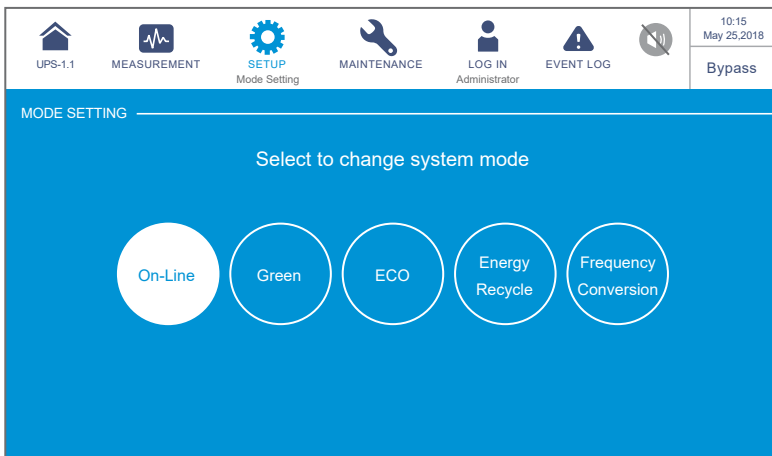

(Figure 6-61: Select On-Line Mode)

- 6 **Single Input:**
Switch **OFF** the UPS's bypass switch (Q0) and Delta or non-Delta external maintenance bypass cabinet's input breaker or switch (Q1).
- Dual Input:**
Switch **OFF** the UPS's bypass switch (Q0), Delta or non-Delta external maintenance bypass cabinet's input breaker or switch (Q1) and bypass breaker or switch (Q2).

- 7) Now, each power module performs DC BUS discharging and its LED indicator flashes green. After discharging, each power module's LED indicator will be off.
- 8) About 3 minutes later, the UPS will shut down. After that, the LCD and the tricolor LED indicator will be off.
- 9) Switch **OFF** every external battery cabinet's breaker (Q5).

6.3.7 Green Mode Turn-off Procedures



WARNING:

1. For parallel units, ensure that every operation procedure mentioned below is synchronized to all parallel UPSs.
2. For parallel application, if you just want to operate a specific UPS but not all parallel ones, please contact service personnel.

- 1) In green mode, the LCD shows the following screen (**Figure 6-62**) and the tri-color LED indicator illuminates green. For the tri-color LED indicator location, please refer to **Figure 2-11**.

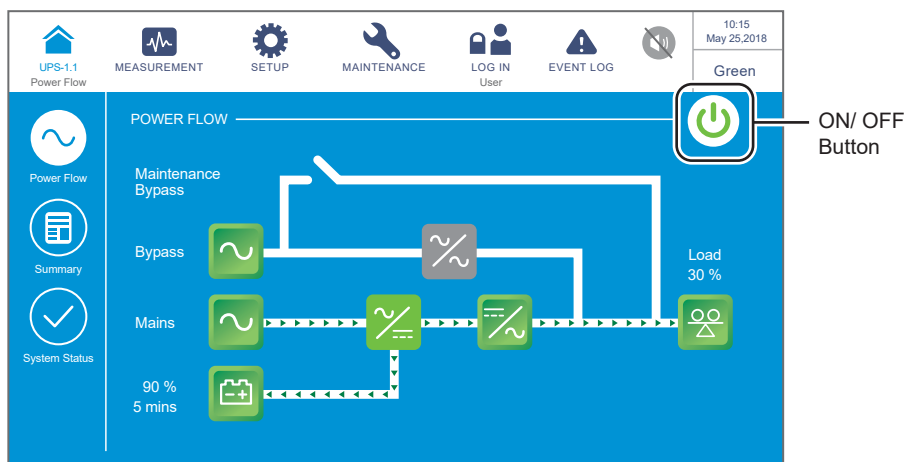

(Figure 6-62: Green Mode Screen & ON/ OFF Button Location)

- 2) Press the ON/ OFF button () once and the following screen will pop up to ask you if you want to power off the UPS's inverter. Please select 'YES'.

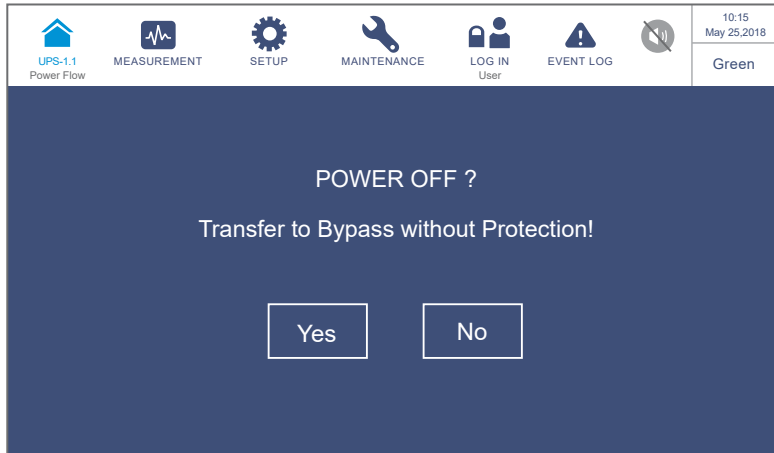

(Figure 6-63: Power Off Reminder Screen)

- 3 After selection of 'YES', the UPS will shut down each power module's output and let the bypass AC source supply power. If the bypass AC source is abnormal, there is a risk of output interruption and the connected critical loads won't be protected. At this moment, each power module keeps charging the batteries, the tri-color LED indicator illuminates yellow and the following screen appears (Figure 6-64). For the tri-color LED indicator location, please refer to Figure 2-11.

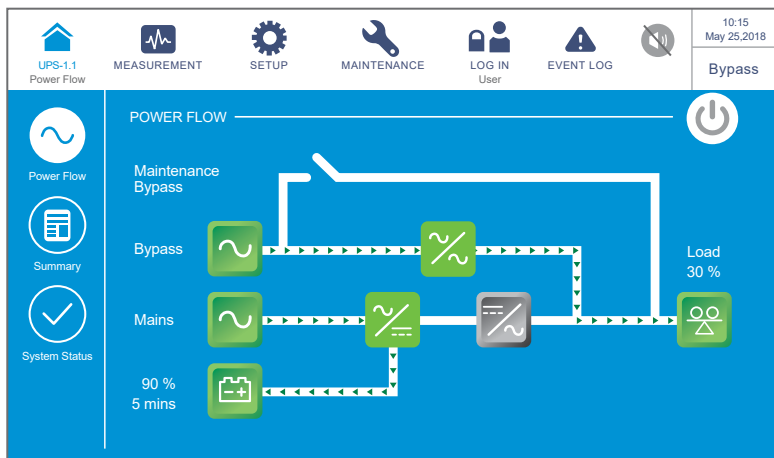

(Figure 6-64: Bypass Mode Screen)

- 4 Please log in as an **Administrator**. For the **Administrator** password, please contact service personnel. After login, ensure that you are in the **Administrator** login status (see Figure 6-65).

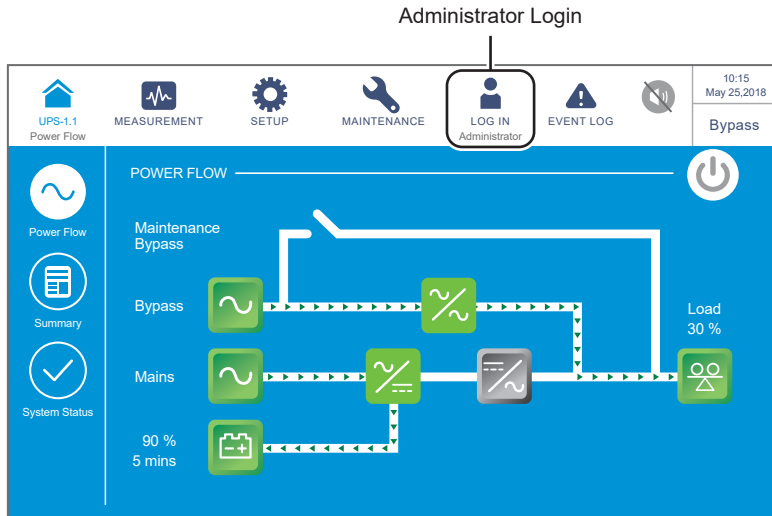

(Figure 6-65 : Bypass Mode Screen_ Administrator Login)

- 5 Click **SETUP** → **Mode Setting** → **On-Line**. If the bypass voltage is in the normal range, the UPS will run in bypass mode to let the bypass AC source supply power to the output.

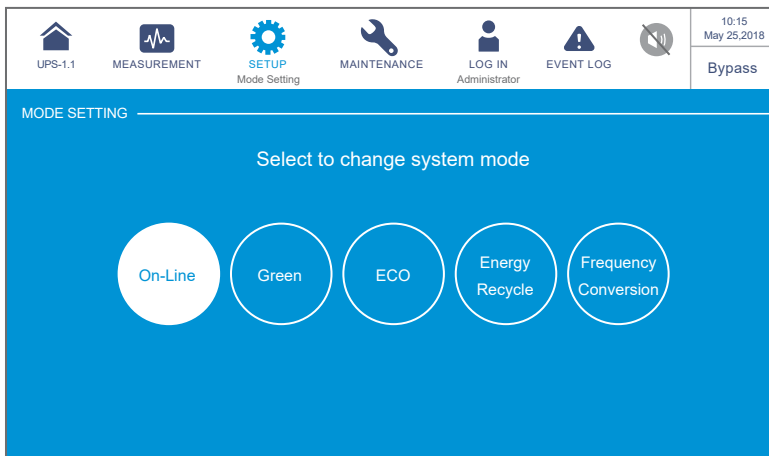

(Figure 6-66: Select On-Line Mode)

- 6 **Single Input:**

Switch **OFF** the UPS's bypass switch (Q0), Delta or non-Delta external maintenance bypass cabinet's input breaker or switch (Q1) and output breaker or switch (Q4).

Dual Input:

Switch **OFF** the UPS's bypass switch (Q0), Delta or non-Delta external maintenance bypass cabinet's input breaker or switch (Q1), bypass breaker or switch (Q2) and output breaker or switch (Q4).

- 7 Now, each power module performs DC BUS discharging and its LED indicator flashes green. After discharging, each power module's LED indicator will be off.
- 8 About 3 minutes later, the UPS will shut down. After that, the LCD and the tricolor LED indicator will be off.
- 9 Switch **OFF** every external battery cabinet's breaker (Q5).

6.3.8 Energy Recycle Mode Turn-off Procedures

WARNING: Energy recycle mode is only applicable to single input and single unit application.

- 1 In energy recycle mode, the LCD shows the following screen (**Figure 6-67**) and the tri-color LED indicator illuminates yellow. For the tri-color LED indicator location, please refer to **Figure 2-11**.

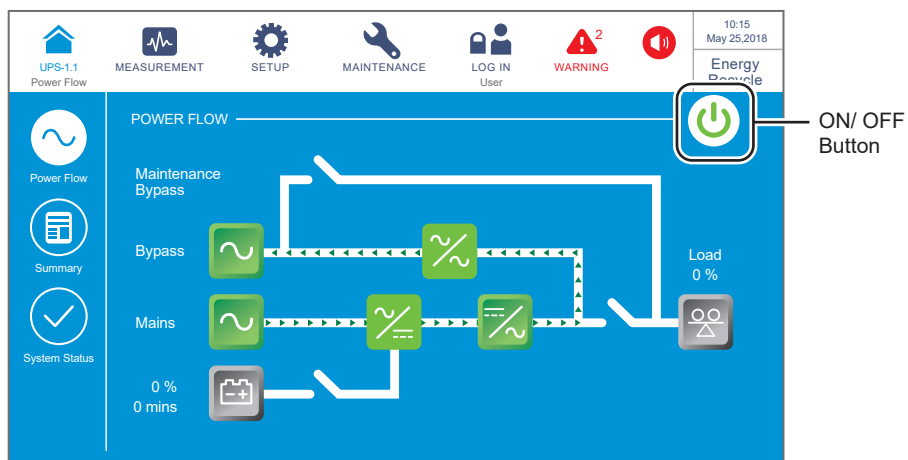

(Figure 6-67: Energy Recycle Mode Screen & ON/ OFF Button Location)

- 2 Press the ON/ OFF button () once and the following screen will pop up to ask you if you want to power off the UPS's inverter. Please select 'YES'.

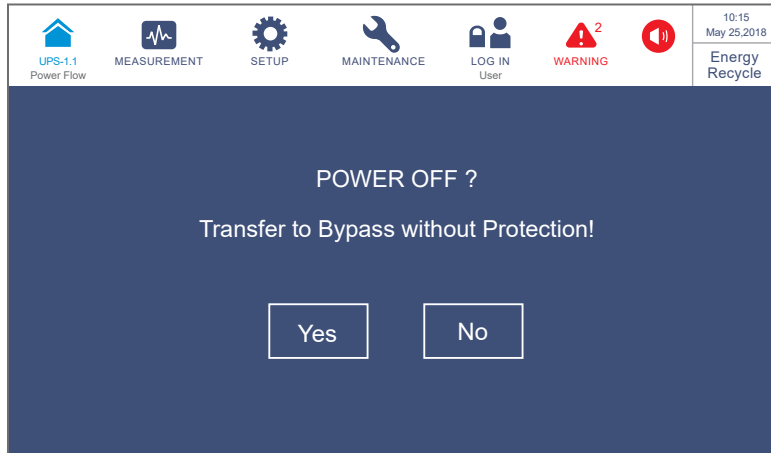

(Figure 6-68: Power off Reminder Screen)

- 3 After selection of 'YES', the UPS will stop self-aging test and transfer to run in bypass mode. At this moment, the tri-color LED indicator illuminates yellow and the following screen appears (Figure 6-69). For the tri-color LED indicator location, please refer to Figure 2-11.

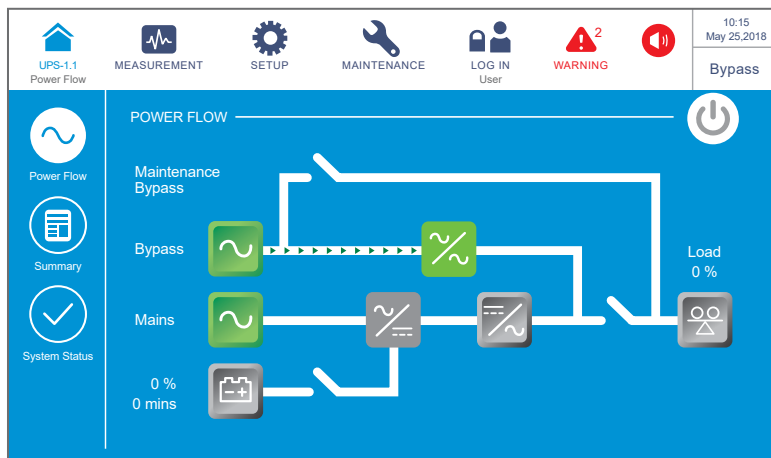

(Figure 6-69: Bypass Mode Screen)

Now, each power module performs DC BUS discharging and its LED indicator flashes green. After discharging, each power module's LED indicator will be off.

- 4 Please log in as an **Administrator**. For the **Administrator** password, please contact service personnel. After login, ensure that you are in the **Administrator** login status (see Figure 6-70).

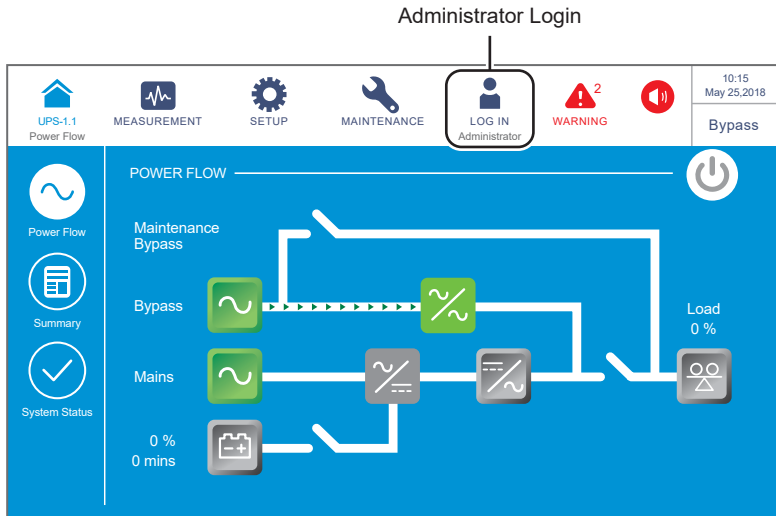

(Figure 6-70 : Bypass Mode Screen_ Administrator Login)

- 5) Click **SETUP** → **Mode Setting** → **On-Line**.

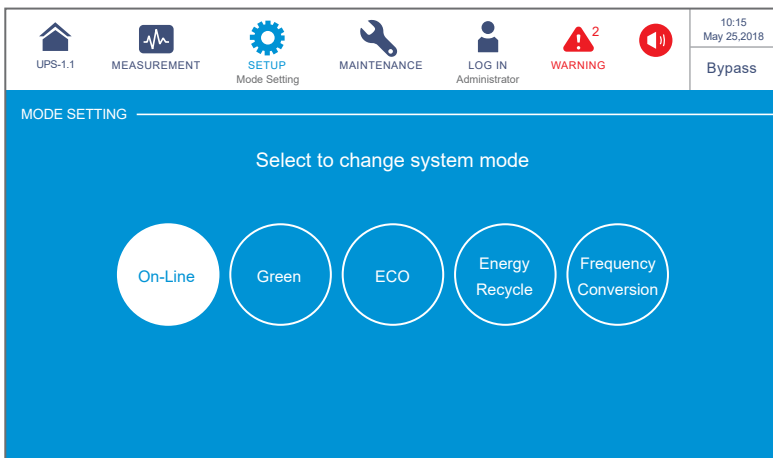

(Figure 6-71: Select On-Line Mode)

- 6) Switch **OFF** the UPS's bypass switch (Q0) and Delta or non-Delta external maintenance bypass cabinet's input breaker or switch (Q1).
- 7) The UPS will shut down, and then, the LCD and the tri-color LED indicator will be off.

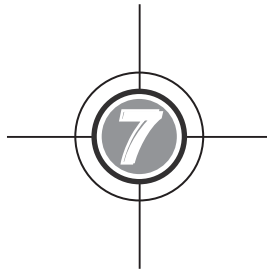

LCD Display & Settings

- 7.1 LCD Display Hierarchy
- 7.2 Turning on the Touch Panel
- 7.3 ON/ OFF Button
- 7.4 Introduction of Touch Panel and Function Keys
- 7.5 Password Entry
- 7.6 Main Screen
- 7.7 Main Menu
- 7.8 Power Flow & Summary & System Status
- 7.9 Check System Readings
- 7.10 UPS Settings
- 7.11 System Maintenance

7.1 LCD Display Hierarchy

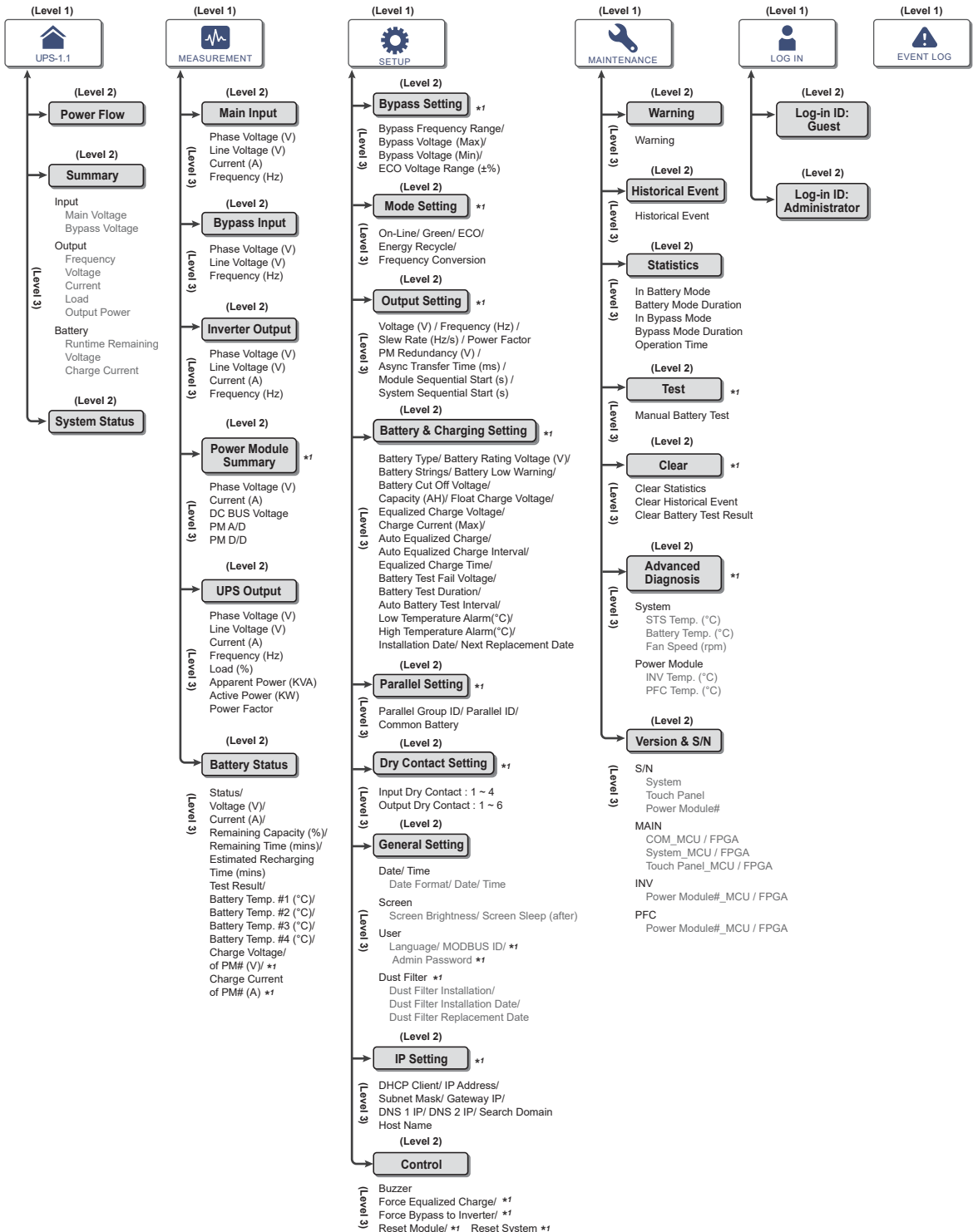

(Figure 7-1: LCD Display Hierarchy)

**NOTE:**

1. *r indicates that the **ADMINISTRATOR** password is needed. For password information, please refer to **7.5 Password Entry**.
2. The information on the LCD screen presented in **7. LCD Display & Settings**, including UPS operation mode, machine number, date, time, total number of alarms, load %, battery remaining time, user login or administrator login, are for reference only. The actual screen of display depends on operation situation.
3. For how to turn on the touch panel, please refer to **7.2 Turning on the Touch Panel** and **7.3 ON/ OFF Button**.

7.2 Turning on the Touch Panel



NOTE: The UPS must be connected with a Delta or non-Delta external maintenance bypass cabinet. The Delta external maintenance bypass cabinet is optional, and the non-Delta external maintenance bypass cabinet is user-supplied and should be handled and configured by Delta service personnel. For the Delta or non-Delta external maintenance bypass cabinet's information, please refer to **1.2 Connection Warnings**.

① Please refer to the following steps to turn on the touch panel.

- a. Switch the bypass switch (Q0) of the UPS to the open (**ON**) position; the touch panel will then light up and the initialization screen will appear; or
- b. Turn the input breaker or switch (Q1) of the Delta or non-Delta external maintenance bypass cabinet to the open (**ON**) position; the touch panel will then light up and the initialization screen will appear; or
- c. Turn the input breaker or switch (Q1) of the Delta or non-Delta external maintenance bypass cabinet and the bypass switch (Q0) of the UPS to the open (**ON**) position; the touch panel will then light up and the initialization screen will appear; or
- d. Turn the external battery cabinet's breaker (Q5) to the open (**ON**) position, open the front door of the UPS, and press any of the battery start buttons on the communication interfaces for 1 second and release it; the touch panel will then light up and the initialization screen will appear. For the location of the battery start buttons, please refer to **Figure 7-2**; for the touch panel initialization screen, please refer to **Figure 7-3**.

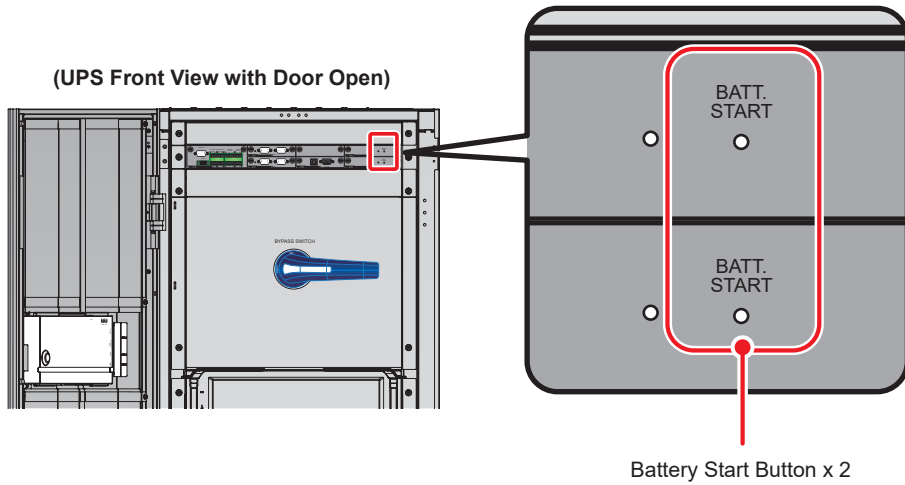

(Figure 7-2: The Position of Battery Start Buttons)



(Figure 7-3: Initialization Screen of Touch Panel)

- 2 About 20 seconds after the touch panel lights up, the main screen will appear (shown in **Figure 7-4**). After the main screen appears, the touch panel could be used. Please note that when the main screen is shown, the login status is **User**.

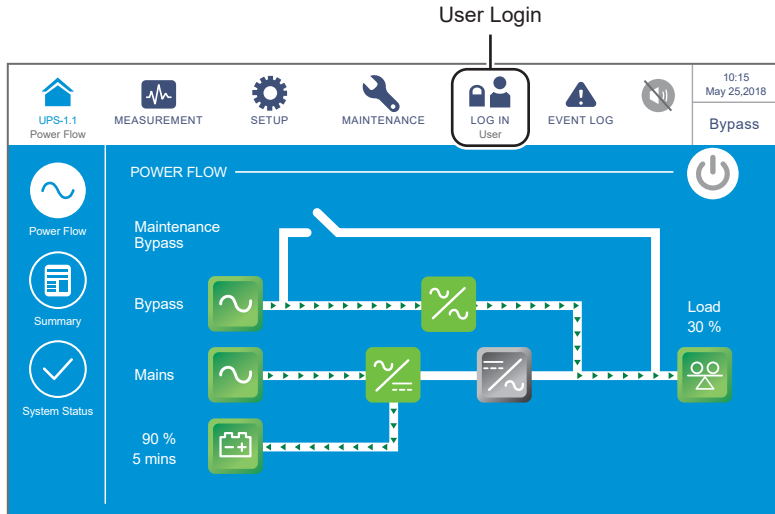

(Figure 7-4: Main Screen_ User Login)

7.3 ON/ OFF Button

After the touch panel is turned on in accordance with the steps stated in **7.2 Turning on the Touch Panel**, the main screen will appear in the **User** login status and the ON/ OFF Button () will appear shown in **Figure 7-5**.

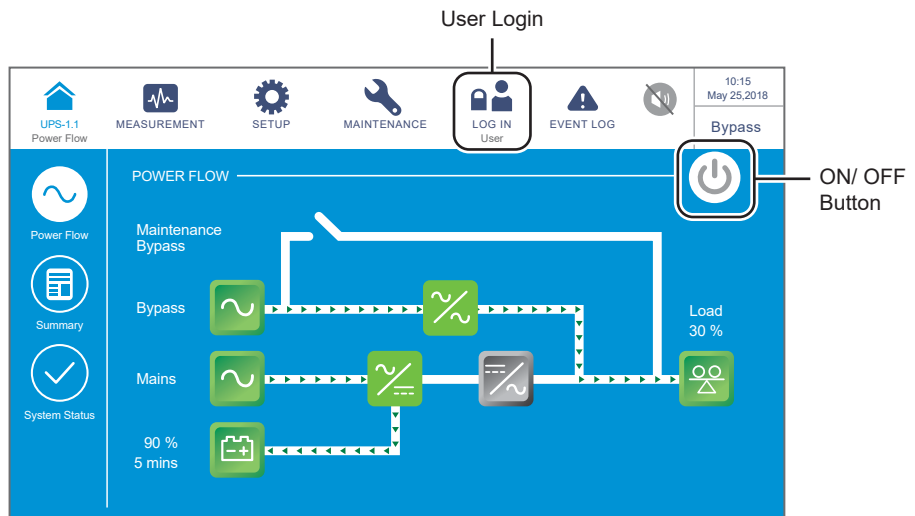

(Figure 7-5: Main Screen_ User Login & ON/ OFF Button Location)

- **Power On**

When the ON/ OFF button is gray (), it indicates that the UPS's inverter is in the **OFF** status. Press the button once and a reminder window will pop up shown below asking for confirmation of '**POWER ON**'.

After selecting '**Yes**', the ON/ OFF button will turn green (), indicating that the power-on process is completed.

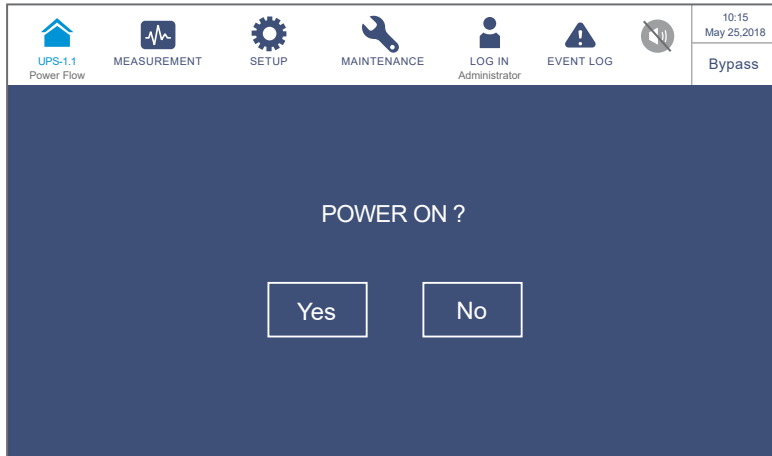

(Figure 7-6: Power On Reminder Window)

- **Power Off**

When the ON/ OFF button is green (), it indicates that the UPS's inverter is in the **ON** status. Press the button once and a reminder window will pop up shown below asking for confirmation of '**POWER OFF**'.

After selecting '**Yes**', the ON/ OFF button will turn gray (), indicating that the power-off process is completed.

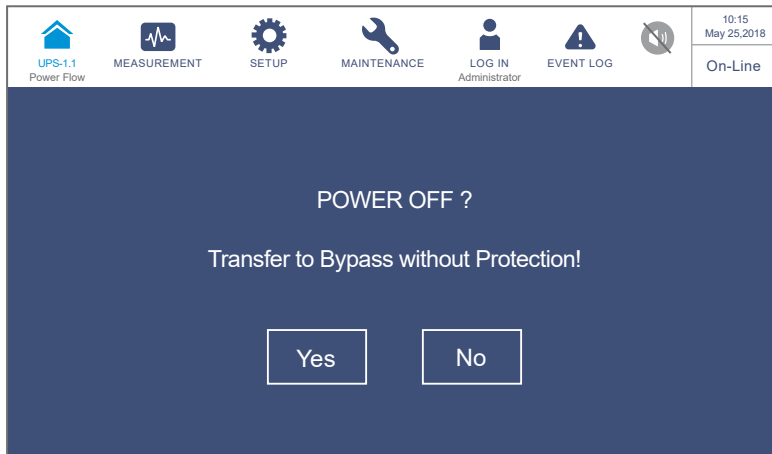





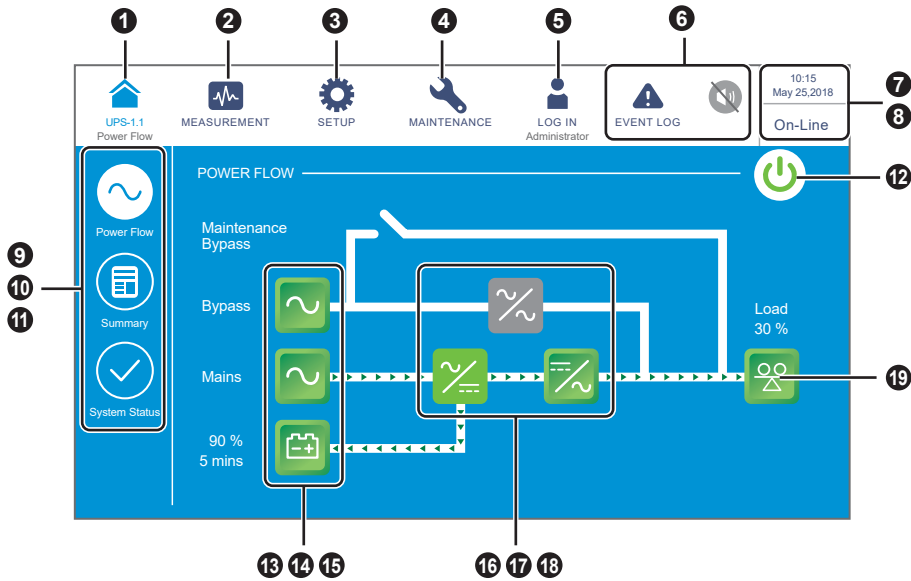













(Figure 7-7: Power Off Reminder Window)



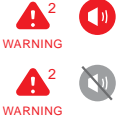



7.4 Introduction of Touch Panel and Function Keys







(Figure 7-8: Introduction of Touch Panel and Function Keys)







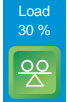

No.	Icon/ Text	Button Function (Yes or No)	Text/ Digital Display (Yes or No)	Symbol Display (Yes or No)	Description
1	 UPS-1.1	✓	✓		<p>Back to the main screen. The UPS-1.1 shown below the symbol  indicates the group ID and parallel ID of the UPS.</p> <p> NOTE: For the parallel UPSs (at maximum eight), if you press the master UPS's icon (), you can check the master UPS's every status and readings and also other slave UPSs' partial status and partial readings. If you press any of the slave UPSs' icons (), you can only check the slave UPS's partial status and partial readings.</p>







No.	Icon/ Text	Button Function (Yes or No)	Text/ Digital Display (Yes or No)	Symbol Display (Yes or No)	Description
2	 MEASUREMENT	✓			Shortcut button for the measurement menu. For more information, please refer to 7.9 Check System Readings .
3	 SETUP	✓			Shortcut button for the setup menu. For more information, please refer to 7.10 UPS Settings .
4	 MAINTENANCE	✓			Shortcut button for the maintenance menu. For more information, please refer to 7.11 System Maintenance .
5	 LOG IN User	✓		✓	Indicates login by User . The button can be pressed to change the login permission. For more information, please refer to 7.5 Password Entry .
	 LOG IN Administrator	✓		✓	Indicates login by Administrator . The button can be pressed to change the login permission. For more information, please refer to 7.5 Password Entry .
6	 EVENT LOG	✓		✓	<ol style="list-style-type: none"> 1. Event log shortcut button (). Press the button to check the total event logs. 2. When the warning symbol () is blue, it indicates that there is no warning.
		✓	✓	✓	<ol style="list-style-type: none"> 1. Warning event shortcut button (). 2. Buzzer button (). 3. When the warning symbol () is red, it indicates that there is a warning. At this time, the buzzer will sound and the buzzer symbol () will appear and light up. The numerical value at the right of the red warning symbol indicates the total number of warning events. By clicking the buzzer button (), the buzzer will be muted. At this time, the buzzer disabled symbol () will appear.

No.	Icon/ Text	Button Function (Yes or No)	Text/ Digital Display (Yes or No)	Symbol Display (Yes or No)	Description
7	10:15 May 25,2018		✓		Indicates the time and date.
8	On-Line ECO Frequency Conversion Green Energy Recycle Bypass Battery Standby Softstart		✓		Indicates the UPS operation status (the actual display will depend on the actual operation status).
9		✓			Shortcut button for power flow diagram. Press the button to check the operation mode and status of the UPS. For more information, please refer to 7.8 Power Flow & Summary & System Status .
10		✓			Shortcut button for summary information. Press the button to check the input, output, and battery status of the UPS. For more information, please refer to 7.8 Power Flow & Summary & System Status .
11		✓			Shortcut button for system status. Press the button to check the status of each power module, parallel communication card, system control card, and auxiliary power card. For more information, please refer to 7.8 Power Flow & Summary & System Status .
12		✓		✓	ON/ OFF button. For more information, please refer to 7.3 ON/ OFF Button .
13	Bypass 	✓		✓	1. Bypass input status (green: normal; red: abnormal). 2. Bypass input screen shortcut button.
14	Mains 	✓		✓	1. Main input status (green: normal; red: abnormal). 2. Main input screen shortcut button.

No.	Icon/ Text	Button Function (Yes or No)	Text/ Digital Display (Yes or No)	Symbol Display (Yes or No)	Description
15		✓	✓	✓	<ol style="list-style-type: none"> Battery status (green: normal; red: abnormal). Battery remaining capacity (%). Battery remaining time (minutes). Battery status screen shortcut button.
16				✓	Bypass static switch status (green: ON ; gray: OFF).
17				✓	Rectifier status (green: normal; gray: waiting or OFF).
18		✓		✓	<ol style="list-style-type: none"> Inverter status (green: normal; gray: wait or OFF). Inverter output screen shortcut button.
19		✓	✓	✓	<ol style="list-style-type: none"> Output status (green: normal; gray: no output). Load capacity (%). Output screen shortcut button.

Other symbols which will appear during the operation of the touch panel are shown in the table below.



No.	Symbol	Function
1		First Page
		
2		Last Page
3		Up
		
4		Down
		
5		Add

No.	Symbol	Function
6		Subtract
7		Enter page number
8		Delete
		
9		Capital letter
10		Blank

**NOTE:**

1. After the back light is turned off, the user can gently touch the LCD to return to the **Main Screen**. For information about the **Main Screen**, please refer to **7.6 Main Screen**.
2. The sleep time for the back light can be adjusted. Please refer to **7.10.7 General Setting**.
3. If you are logged in as an **Administrator** (the **Administrator** password is required; please refer to **7.5 Password Entry**), you will be logged out when the backlight is off. After you touch the screen to wake it up, the LCD will go back to the **Main Screen** in the **User** login status. Even if you set up the backlight in '**Never Sleep**' mode, you will still be logged out after the screen is idle for 5 minutes.
4. The default language is English. If the language needs to be changed, please click  → **General Setting** → **User** → **Language** to change the displayed language of the screen. The default language will be different in different countries.

7.5 Password Entry

1. Password entry is only required for login as an **Administrator**. **User** login does not require a password.
2. Click  → enter the **Administrator** password (please contact service personnel for the default password) → the icon  appears, indicating **Administrator** login is successful.
3. To change the **Administrator** password, click  → **General Setting** → **User** → **Administrator Password** (4 digits).



NOTE: Different login IDs (Administrator/ User) have different access to different screens, inspection items and setup items. Please refer to **7.1 LCD Display Hierarchy**.

7.6 Main Screen

1. Please refer to **7.2 Turning on the Touch Panel** and **7.3 ON/ OFF Button** for starting up the **Main Screen**.
2. The system shows different power flow screens depending on the status of the UPS. Each power flow screen is a **Main Screen**. See the examples below.

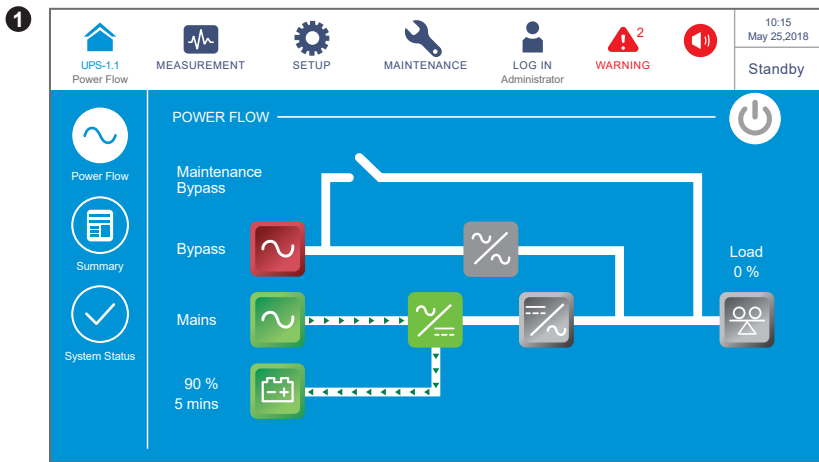

The screen above indicates that the UPS is in standby mode. The inverter is not turned on and the bypass is out of the range.

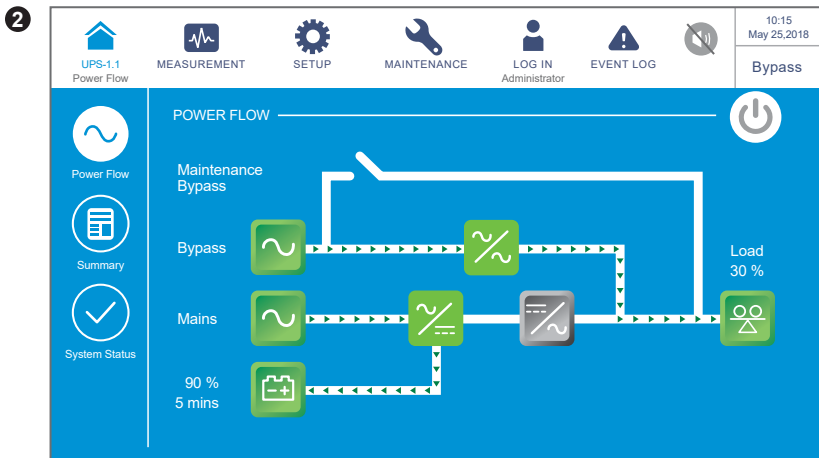

The screen above indicates that the UPS is in bypass mode and the inverter is not turned on.

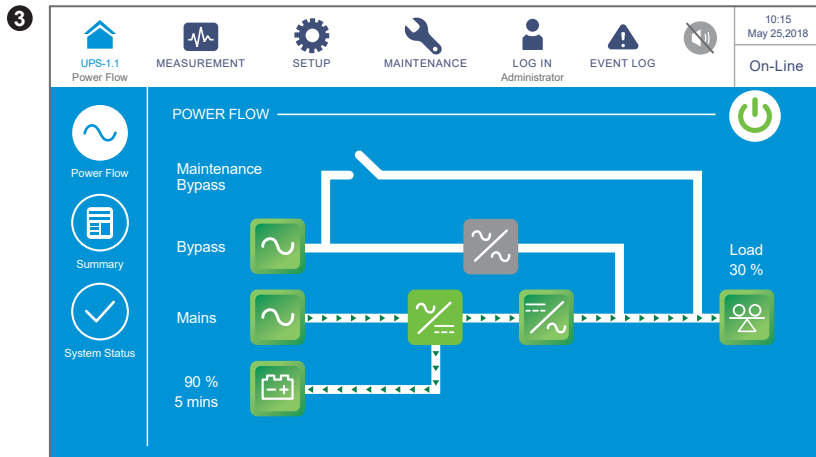

The screen above indicates that the UPS is in online mode and the loads are supplied by the inverter. Please refer to **7.10.2 Mode Setting** and **6.2.1 Online Mode Start-up Procedures**.

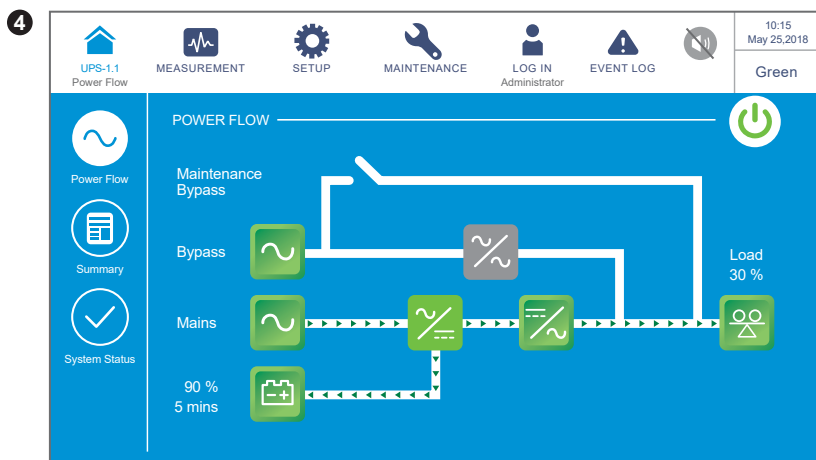

The screen above indicates that the UPS is in green mode. The loads are supplied by the inverter, and alternating power modules will turn off in accordance with the total load situation. For green mode settings, please refer to **7.10.2 Mode Setting** and **6.2.7 Green Mode Start-up Procedures**.

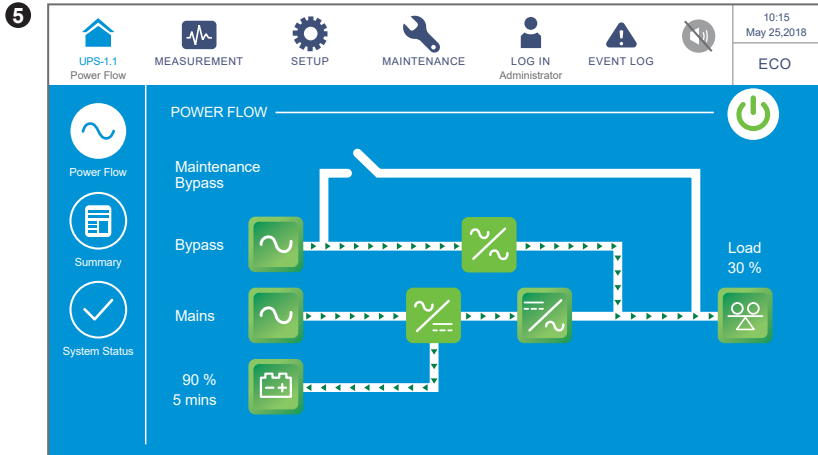

The screen above indicates that the UPS is in ECO mode. The inverter is in the ready-to-power-on status, and the loads are supplied by the bypass. For ECO mode settings, please refer to **7.10.2 Mode Setting** and **6.2.5 ECO Mode Start-up Procedures**.

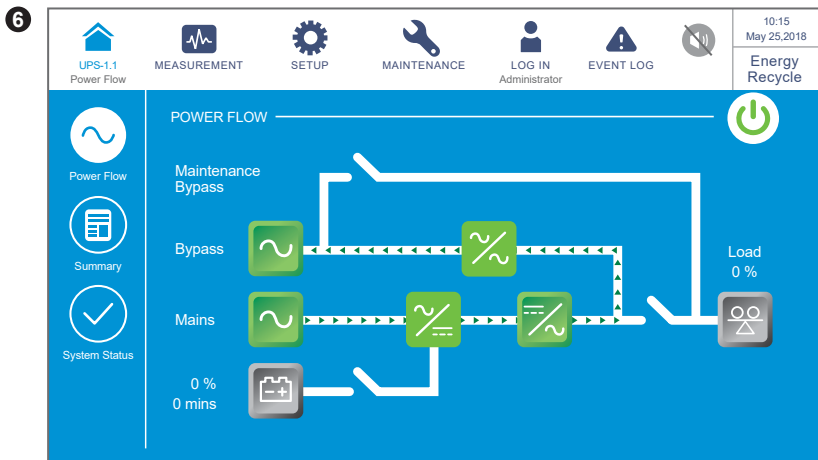

The screen above indicates that the UPS is in energy recycle mode. The output power will be recycled to the input without being sent to the loads and the aging test could be conducted. For energy recycle mode settings, please refer to **7.10.2 Mode Setting** and **6.2.8 Energy Recycle Mode Start-up Procedures**.

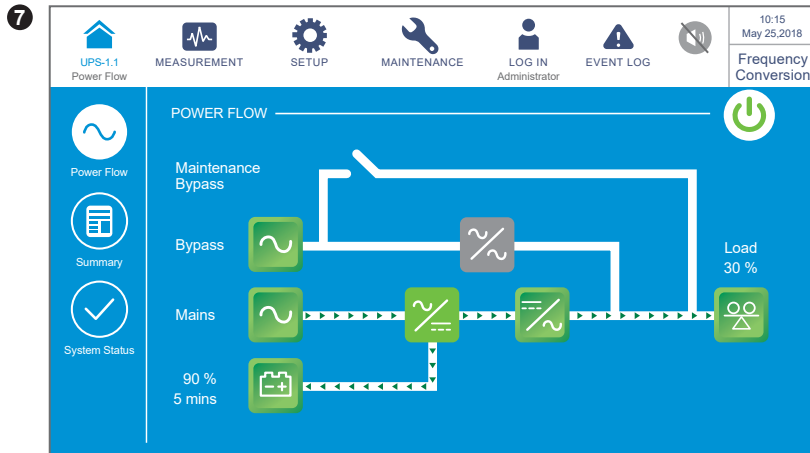

The screen above indicates that the UPS is in frequency conversion mode and the bypass output is restricted. For frequency conversion mode settings, please refer to **7.10.2 Mode Setting** and **6.2.6 Frequency Conversion Mode Start-up Procedures**.

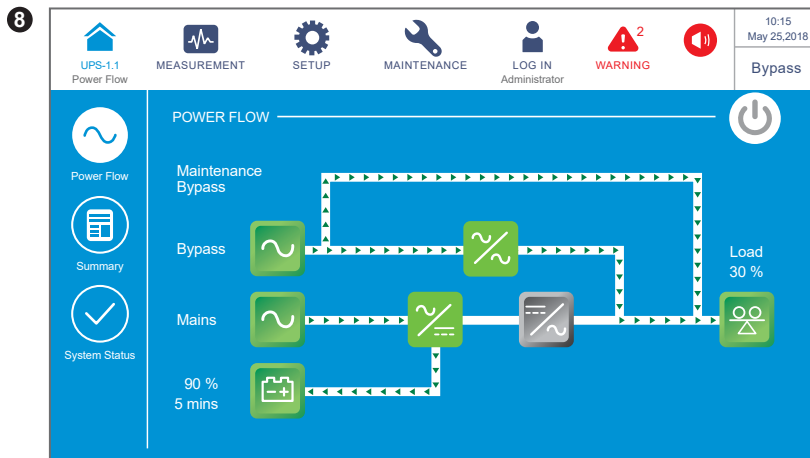



After the Delta or non-Delta external maintenance bypass cabinet's manual bypass breaker or switch (Q3) is turned on, the UPS will be switched to manual bypass mode, and the screen above will appear. Before maintenance personnel perform maintenance, the UPS must be switched to this mode and it must be ensured that all input power and battery power are disconnected. After power disconnection, the LCD will be off. If there is any sudden malfunction in the bypass, the loads will lose power and become unprotected. Please refer to **6.2.4 Manual Bypass Mode Start-up Procedures**.

7.7 Main Menu

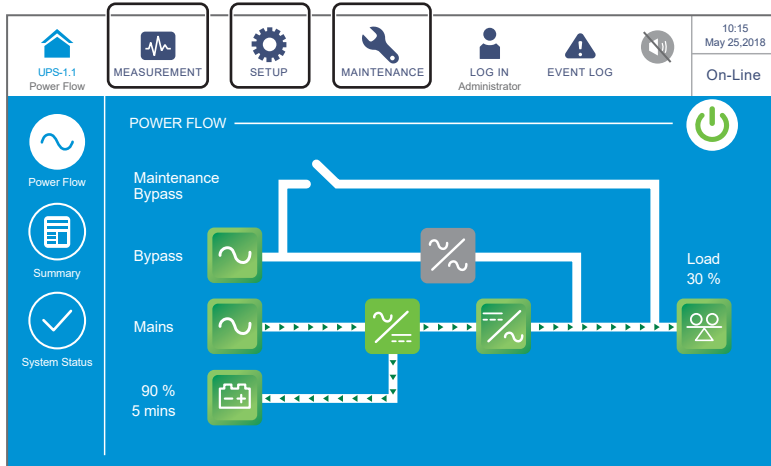
There are three main menu buttons  ,  ,  ; positions are shown in the figure below.



Main Menu Button	Description
 MEASUREMENT	<p>Press the button to go to the Measurement Menu. In the menu, you can check the UPS's readings including the following:</p> <ol style="list-style-type: none"> 1. Main Input 2. Bypass Input 3. Inverter Output 4. Power Module Summary 5. UPS Output 6. Battery Status <p>For more information, please refer to 7.9 Check System Readings.</p>
 SETUP	<p>Press the button to go to the Setup Menu. In the menu, you can set up the following settings.</p> <ol style="list-style-type: none"> 1. Bypass Setting 2. Mode Setting 3. Output Setting 4. Battery & Charging Setting 5. Parallel Setting 6. Dry Contact Setting 7. General Setting 8. IP Setting 9. Control <p>For more information, please refer to 7.10 UPS Settings.</p>

Main Menu Button	Description
 MAINTENANCE	<p>Press the button to go to the Maintenance Menu. In the menu, you can (1) check the warning events/ historical events/ statistics/ relevant temperature readings/ firmware version, (2) execute the manual battery test, (3) clear the statistics/ historical event/ battery test result, and (4) upgrade firmware. In the Maintenance Menu, it includes the following items.</p> <ol style="list-style-type: none"> 1. Warning 2. Historical Event 3. Statistics 4. Test 5. Clear 6. Advanced Diagnosis 7. Version & S/N <p>For more information, please refer to 7.11 System Maintenance.</p>



NOTE: Different login IDs (Administrator/ User) have different access to different screens, inspection items and setup items. Please refer to **7.1 LCD Display Hierarchy**.

7.8 Power Flow & Summary & System Status

There are three shortcut buttons for you to check the **Power Flow**, **Summary**, and **System Status** respectively. Please see the figure below.

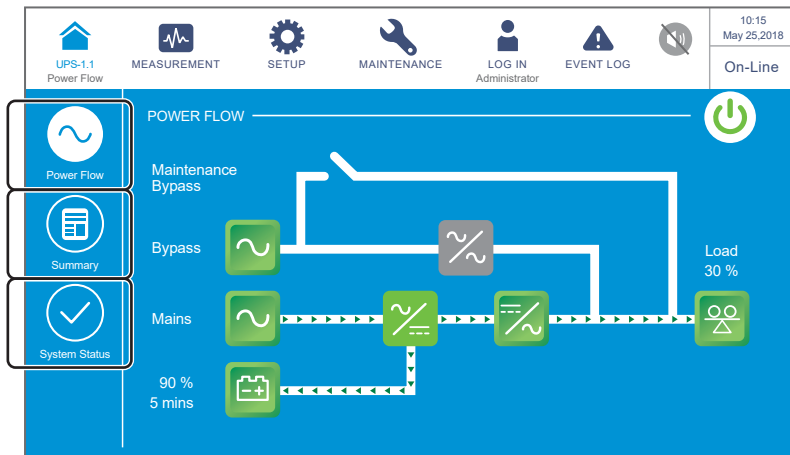

Press the  button to check the UPS's power flow diagram, shown in the figure below.

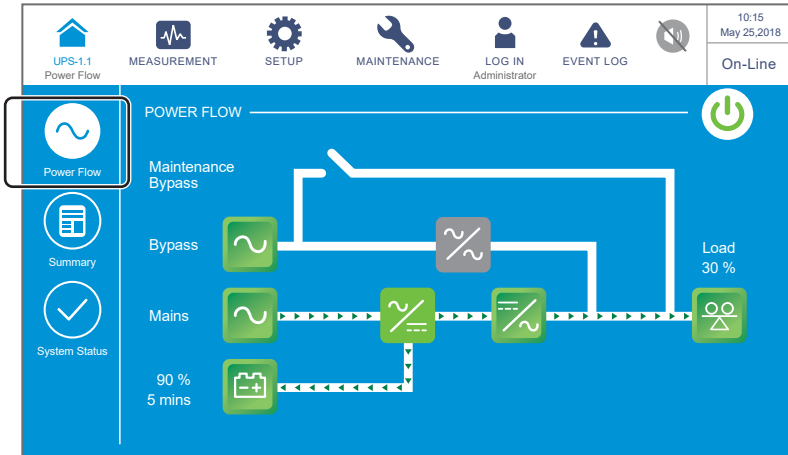

Press the  button to check information related to input, output and battery, shown in the figure below.

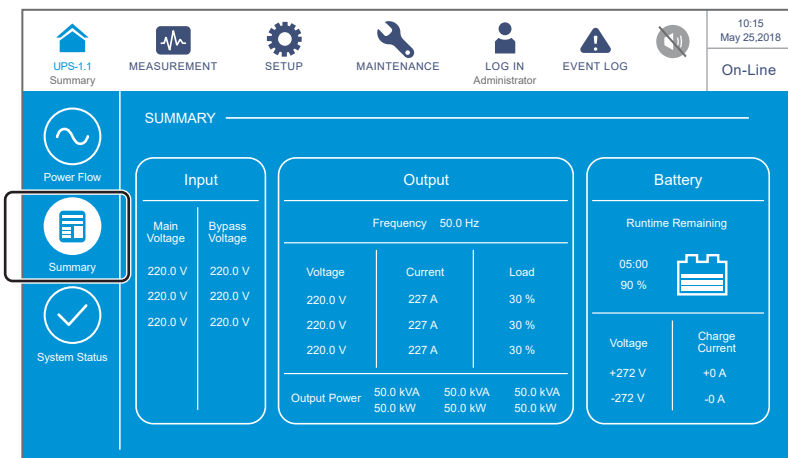

Press the  button to check the status of the STS module, power module, parallel communication card, system control card and auxiliary power card, shown in the figure below.

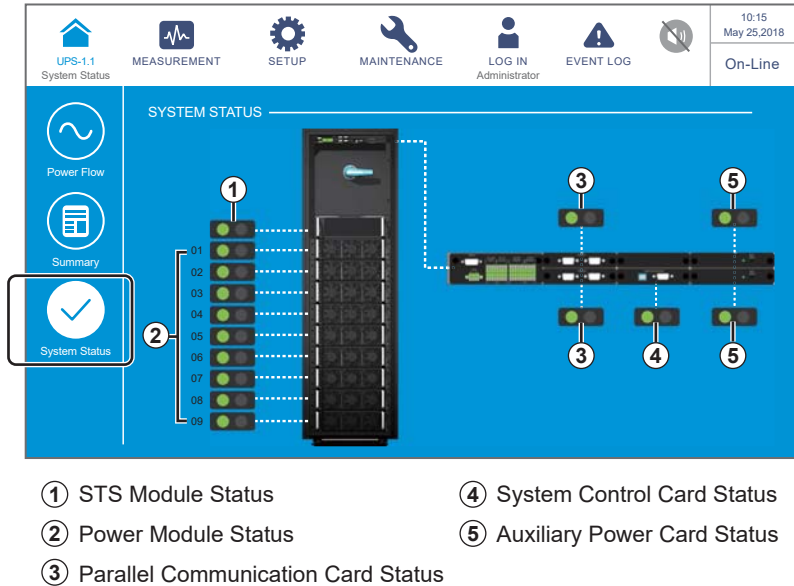

7.9 Check System Readings

7.9.1 Main Input

Path:  → Main Input

After entering the **MAIN INPUT** screen (shown in the figure below), the user can inquire about the **Phase Voltage**, **Line Voltage**, **Current** and **Frequency** readings.

Phase Voltage(V)	220.0	220.0	220.0	Frequency(Hz)	50.0
Line Voltage(V)	380.0	380.0	380.0		
Current(A)	-	-	-		

7.9.2 Bypass Input

Path:  → Bypass Input

After entering the **BYPASS INPUT** screen (shown in the figure below), the user can inquire about the **Phase Voltage**, **Line Voltage** and **Frequency** readings.

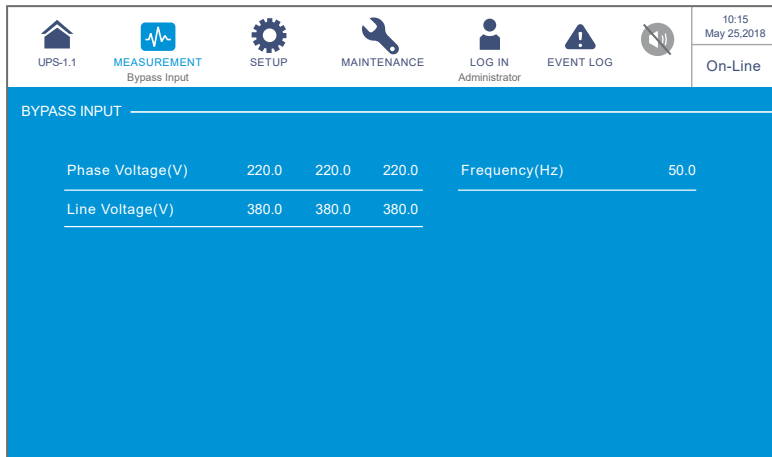

7.9.3 Inverter Output

Path:  → Inverter Output

After entering the **INVERTER OUTPUT** screen (shown in the figure below), the user can inquire about each power module's **Phase Voltage**, **Line Voltage**, **Current** and **Frequency** readings.

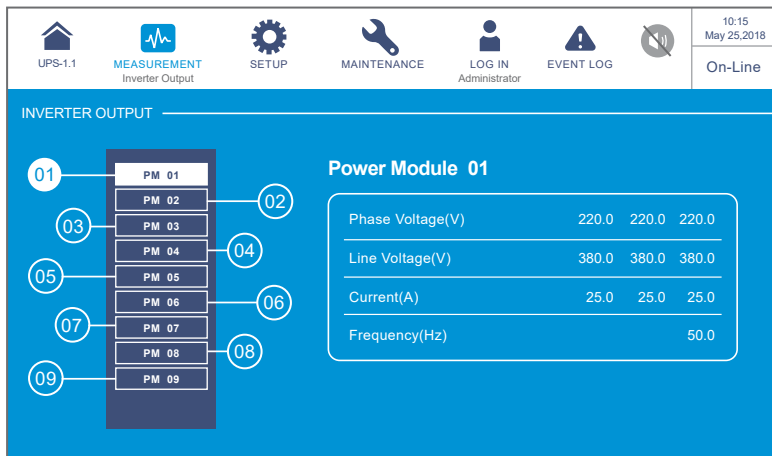

7.9.4 Power Module Summary

Path:  → **Power Module Summary**

After entering the **POWER MODULE SUMMARY** screen (shown in the figure below), the user can inquire about each power module's **Phase Voltage**, **Current**, **DC BUS Voltage**, **PM A/D** and **PM D/D** readings.

UPS-1.1	MEASUREMENT Power Module Summary	SETUP	MAINTENANCE	LOG IN Administrator	EVENT LOG	10:15 May 25, 2018	On-Line		
POWER MODULE SUMMARY									
Power Module#	1	2	3	4	5	6	7	8	9
Phase Voltage(V)	220.0 220.0 220.0	220.0 220.0 220.0	220.0 220.0 220.0	220.0 220.0 220.0	220.0 220.0 220.0	220.0 220.0 220.0	220.0 220.0 220.0	220.0 220.0 220.0	220.0 220.0 220.0
Current(A)	25.0 25.0 25.0	25.0 25.0 25.0	25.0 25.0 25.0	25.0 25.0 25.0	25.0 25.0 25.0	25.0 25.0 25.0	25.0 25.0 25.0	25.0 25.0 25.0	25.0 25.0 25.0
DC BUS Voltage	360.0 360.0	360.0 360.0	360.0 360.0	360.0 360.0	360.0 360.0	360.0 360.0	360.0 360.0	360.0 360.0	360.0 360.0
PM A/D	On	On	On	On	On	On	On	On	On
PM D/D	Off	Off	Off	Off	Off	Off	Off	Off	Off

7.9.5 UPS Output

Path:  → **UPS Output**

After entering the **UPS OUTPUT** screen (shown in the figure below), the user can inquire about **Phase Voltage**, **Line Voltage**, **Current**, **Frequency**, **Load**, **Apparent Power**, **Active Power** and **Power Factor** readings.

UPS-1.1	MEASUREMENT UPS Output	SETUP	MAINTENANCE	LOG IN Administrator	EVENT LOG	10:15 May 25, 2018	On-Line
UPS OUTPUT							
Phase Voltage(V)	220.0	220.0	220.0	Apparent Power(KVA)	230.0	154.6	168.2
Line Voltage(V)	380.0	380.0	380.0	Active Power(KW)	6391.7	6444.7	118.4
Current(A)	227.0	227.0	227.0	Power Factor	0.00	0.00	0.70
Frequency(Hz)	50.0						
Load(%)	30%	30%	30%				

7.9.6 Battery Status

Path:  → **Battery Status**

After entering the **BATTERY STATUS** screen (shown in the figure below), the user can inquire about **Status, Voltage, Current, Remaining Capacity, Remaining Time, Estimated Recharging Time, Test Result, Battery Temperature (#1~#4)**, and each power module's **Charge Voltage** and **Charge Current**.

UPS-1.1				MEASUREMENT Battery Status				SETUP				MAINTENANCE				LOG IN Administrator				EVENT LOG				10:15 May 25, 2018																							
On-Line																																															
BATTERY STATUS																																															
PAGE 1												PAGE 2																																			
Status												None												Test Result												None											
Voltage(V)						+ 272.0						- 272.0						Battery Temp. #1 (°C)						-																							
Current(A)						+ 0						- 0						Battery Temp. #2 (°C)						-																							
Remaining Capacity (%)						90						Battery Temp. #3 (°C)						-																													
Remaining Time (mins)						05:00						Battery Temp. #4 (°C)						-																													
Estimated Recharging Time (mins)						00:00																																									

UPS-1.1				MEASUREMENT Battery Status				SETUP				MAINTENANCE				LOG IN Administrator				EVENT LOG				10:15 May 25, 2018			
On-Line																											
BATTERY STATUS																											
PAGE 1												PAGE 2															
Power Module#		1		2		3		4		5		6		7		8		9									
Charge Voltage of PM# (V)		+ 272.0		+ 272.0		+ 272.0		+ 272.0		+ 272.0		+ 272.0		+ 272.0		+ 272.0		+ 272.0									
		- 272.0		- 272.0		- 272.0		- 272.0		- 272.0		- 272.0		- 272.0		- 272.0		- 272.0									
Charge Current of PM# (A)		+ 1.0		+ 1.0		+ 1.0		+ 1.0		+ 1.0		+ 1.0		+ 1.0		+ 1.0		+ 1.0									
		- 1.0		- 1.0		- 1.0		- 1.0		- 1.0		- 1.0		- 1.0		- 1.0		- 1.0									

7.10 UPS Settings

7.10.1 Bypass Setting

Path:  → **Bypass Setting**

After entering the **BYPASS SETTING** screen (shown in the figure below), the user can set up the **Bypass Frequency Range**, **Bypass Voltage (Max.)**, **Bypass Voltage (Min.)** and **ECO Voltage Range**. If the range is exceeded, the system will issue an alarm. Only qualified service personnel can perform the above-mentioned setup items. Please contact Delta customer service for assistance.

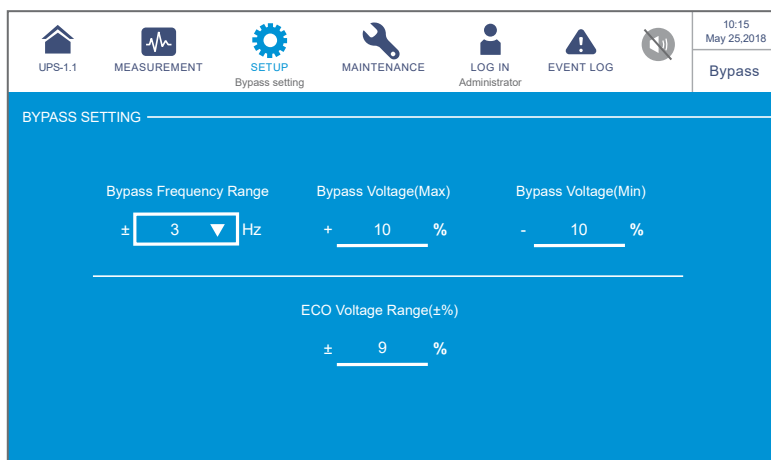

Item	Description
Bypass Frequency Range	Set up the bypass output's frequency range.
Bypass Voltage (Max.)	Set up the bypass output's maximum voltage.
Bypass Voltage (Min.)	Set up the bypass output's minimum voltage.
ECO Voltage Range	Set up the bypass output's voltage range in ECO mode.

7.10.2 Mode Setting

Path:  → Mode Setting

After entering the **MODE SETTING** screen (shown in figure below), the user can set up the UPS system mode, of which there are 5 options: **On-Line Mode**, **Green Mode**, **ECO Mode**, **Energy Recycle Mode** and **Frequency Conversion Mode**. These settings must be performed by qualified service personnel. Please contact Delta customer service for assistance.

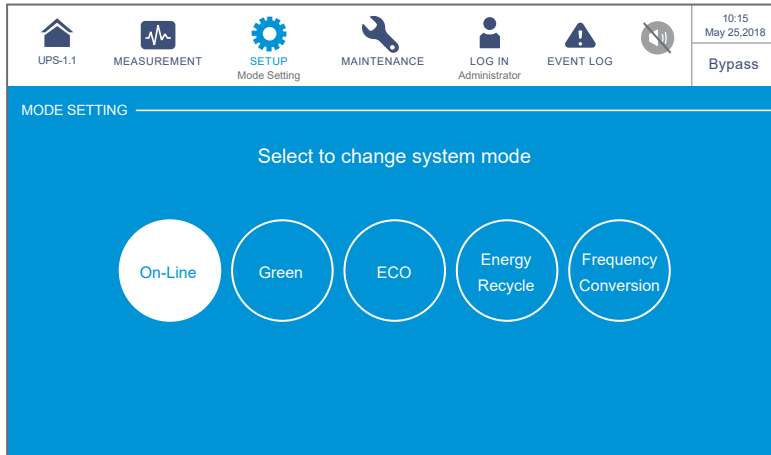

Item	Description
On-Line Mode	Set up the UPS in on-line mode. In on-line mode, it is the inverter to supply power to the connected loads.
Green Mode	Set up the UPS in green mode. In green mode, it is the inverter to supply power to the connected loads and the power modules take turn to rest according to the situation of total load capacity.
ECO Mode	Set up the UPS in ECO mode. In ECO mode, it is the bypass to supply power to the connected loads. It is suggested that you set the UPS in ECO mode only when there is stable main AC power. Otherwise, power supply quality will be compromised.
Energy Recycle Mode	Set up the UPS in energy recycle mode. In energy recycle mode, the full load output can be simulated for the aging test without real output to the loads.
Frequency Conversation Mode	Set up the UPS in frequency conversation mode. In frequency conversation mode, it is the inverter to supply power to the connected loads with a fixed output frequency. Please note that the output will be terminated once the inverter is turned off.

7.10.3 Output Setting

Path:  → **Output Setting**

After entering the **OUTPUT SETTING** screen (shown in the figure below), the user can set up the following items. These settings must be carried out by qualified service personnel. Please contact Delta customer service for assistance.

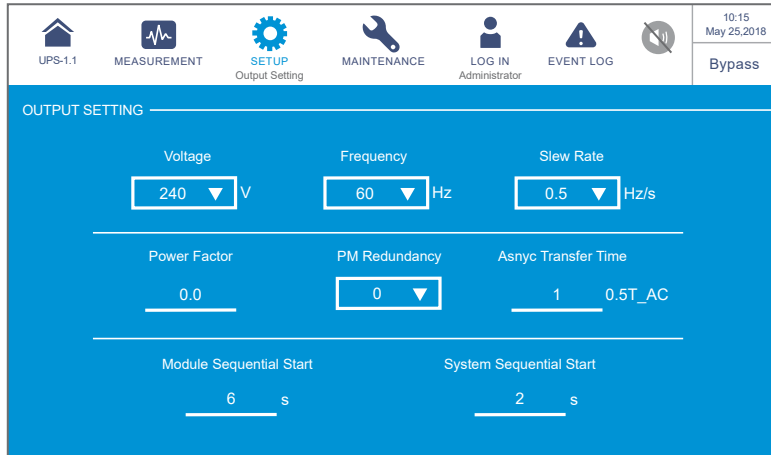

Item	Description
Voltage	Set up the output voltage.
Frequency	Set up the output frequency as 50Hz (default) or 60Hz. The system will automatically select the output frequency in accordance with the bypass power.
Slew Rate	Set up the maximum permissible speed for the system output frequency to catch up the bypass frequency variation.
Power Factor	Set up the output power factor (range: 0.9~1.0).
Power Module Redundancy	Set up how many power modules that need to be preserved for redundancy.
Asynchronous Transfer Time	When it is impossible for the inverter to reach synchronous phase lock with the bypass, the output will be terminated during conversion process according to this setup time.
Module Sequential Start	Set up the time interval for every power module to be converted from the battery mode to online mode. The setup is applicable to the generator to avoid bearing the whole loads right away.
System Sequential Start	Set up the time interval for the system to be converted from the battery mode to online mode. The setup is applicable to the generator to avoid bearing the whole loads right away.

7.10.4 Battery & Charging Setting

Path:  → **Battery & Charging Setting**

In the **BATTERY & CHARGING SETTING** screen (shown in the figure below), the user can set up the following items. These settings must be carried out by qualified service personnel. Please contact Delta customer service for assistance..

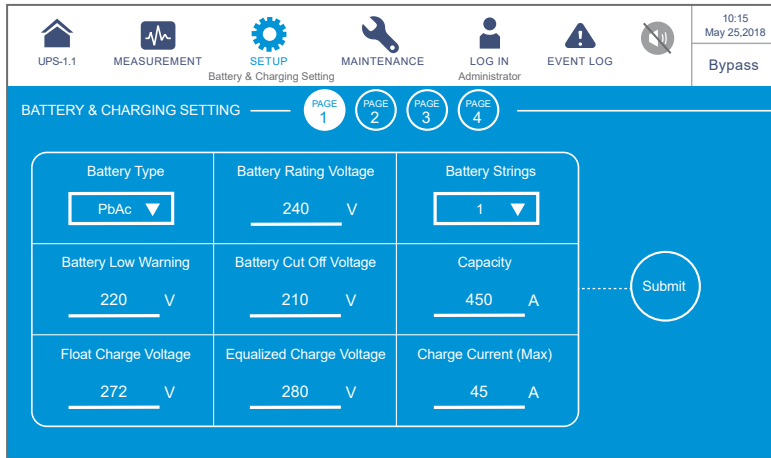

Battery Type	Battery Rating Voltage	Battery Strings
PbAc	240 V	1
Battery Low Warning	Battery Cut Off Voltage	Capacity
220 V	210 V	450 A
Float Charge Voltage	Equalized Charge Voltage	Charge Current (Max)
272 V	280 V	45 A

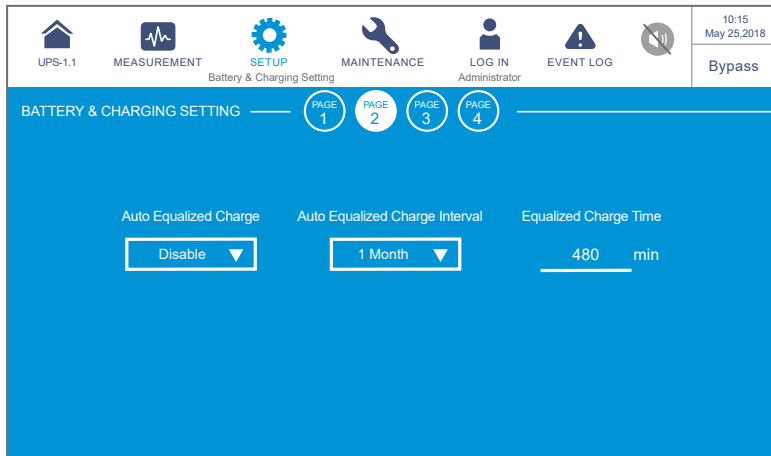

Auto Equalized Charge	Auto Equalized Charge Interval	Equalized Charge Time
Disable	1 Month	480 min

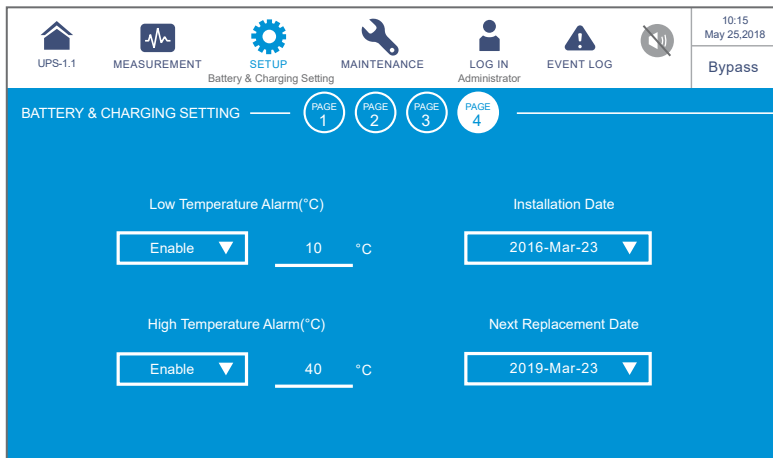
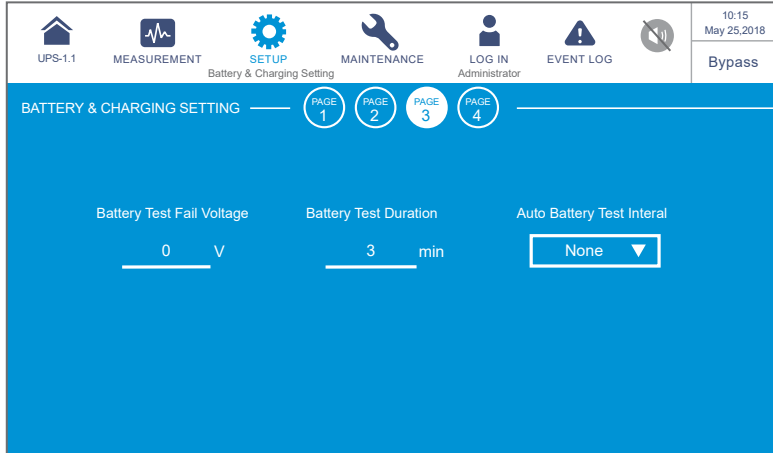

Item	Description
Battery Type	Set up the battery type.
Battery Rating Voltage	Set up the battery rating voltage.
Battery Strings	Set up how many battery strings that are used on site.
Battery Low Warning	Set up the battery low warning voltage.
Battery Cut Off Voltage	Set up the battery low voltage. In battery mode, when the battery low voltage is reached, the battery power will cut off, the UPS will shut down, and the connected loads won't be protected.
Capacity	Set up the battery capacity.
Float Charge Voltage	Set up the float charge voltage.

Item	Description
Equalized Charge Voltage	Set up the equalized charge voltage.
Charge Current (Max.)	Set up the maximum charge current.
Auto Equalized Charge	Enable or disable the auto-equalized charge.
Auto Equalized Charge Interval	Set up the auto equalized charge interval.
Equalized Charge Time	Set up the equalized charge time.
Battery Test Fail Voltage	Set up the battery test fail voltage. When the battery voltage is under the test fail voltage, it means battery fail.
Battery Test Duration	Set up how long the battery test should last.
Auto Battery Test Interval	Set up the battery test interval.
Low Temperature Alarm	Enable or disable the low temperature alarm. If enabled, set up the temperature.
High Temperature Alarm	Enable or disable the high temperature alarm. If enabled, set up the temperature.
Installation Date	Record the battery installation date.
Next Replacement Date	Set up the battery replacement date.

7.10.5 Parallel Setting

Path:  → Parallel Setting

After entering the **PARALLEL SETTING** screen (shown in the figure below), the following items can be set up. These settings must be carried out by qualified service personnel. Please contact Delta customer service for assistance.

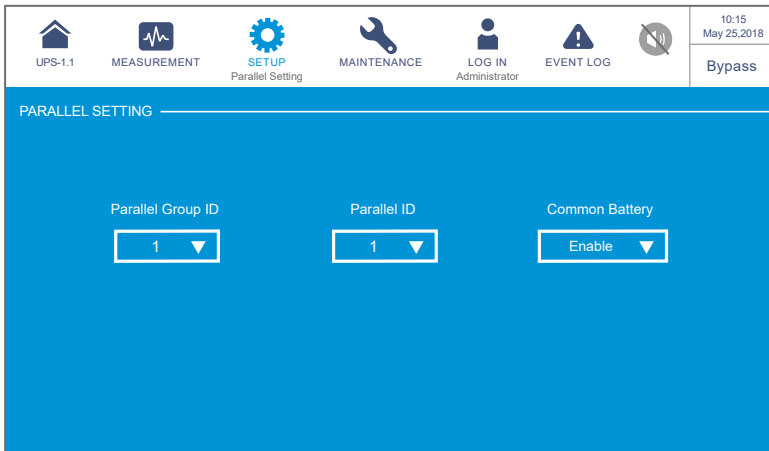

The screenshot displays the 'PARALLEL SETTING' screen. At the top, there is a navigation bar with icons for 'UPS-1.1', 'MEASUREMENT', 'SETUP Parallel Setting', 'MAINTENANCE', 'LOG IN Administrator', 'EVENT LOG', and a 'Bypass' indicator. The main content area has a blue background and contains three dropdown menus: 'Parallel Group ID' with the value '1', 'Parallel ID' with the value '1', and 'Common Battery' with the value 'Enable'.

Item	Description
Parallel Group ID	The UPSs in parallel connection must be assigned the same parallel group ID No. in order to let the outputs of the parallel UPSs be put in parallel connection and let the loads be evenly distributed among the parallel units. If the parallel UPSs have different parallel group ID No., their output signals might be synchronized but their outputs cannot be connected in parallel.
Parallel ID	The UPSs that need to be paralleled must be assigned the same parallel group ID No. and different parallel ID No. in order to let the parallel function work.
Common Battery	If the parallel UPSs that have the same parallel group ID No. need to share common batteries, please select ' Enable ' for the ' Common Battery ' setup item. Otherwise, the function of battery abnormality detection will fail.

7.10.6 Dry Contact Setting

Path:  → **Dry Contact Setting**

In the **DRY CONTACT SETTING** screen (shown in the figure below), the event, NO (normally open) or NC (normally closed) for each of the input and output dry contacts can be set up. These settings must be carried out by qualified service personnel. Please contact Delta customer service for assistance.

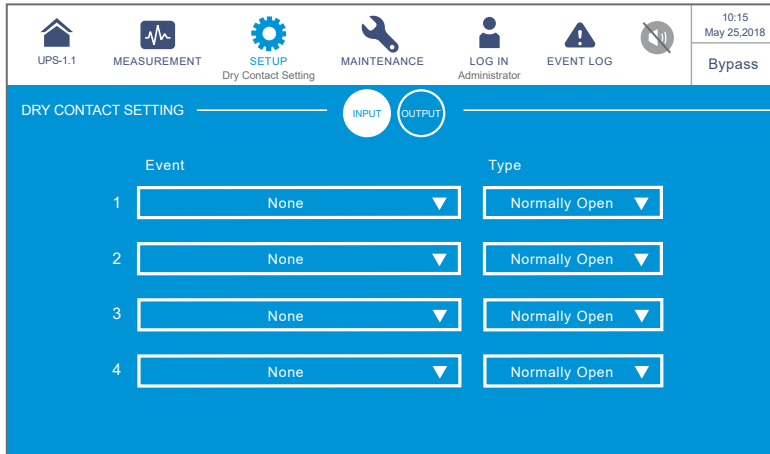

Input Dry Contact No.	Event Selection	Type
Input Dry Contact 1 Input Dry Contact 2 Input Dry Contact 3 Input Dry Contact 4	Select one of the following events as the setting for each input dry contact. 1. None 2. Generator status 3. Battery ground fail 4. External battery breaker detection	Set up NO (normally open) or NC (normally closed) for each input dry contact.

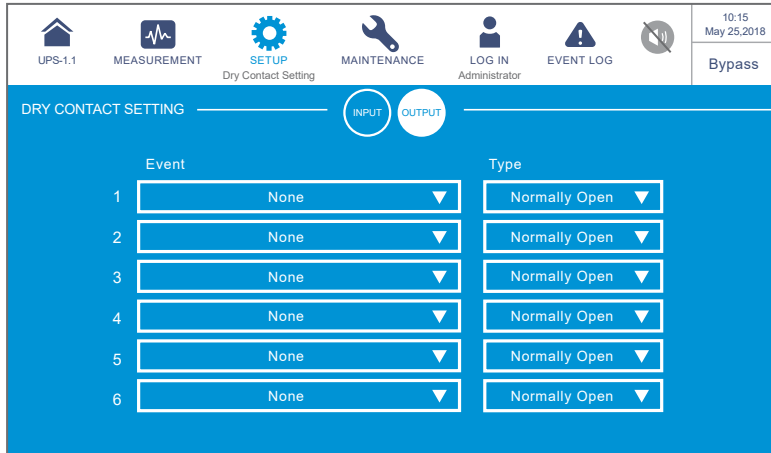

Output Dry Contact No.	Event Selection	Type
Output Dry Contact 1 Output Dry Contact 2 Output Dry Contact 3 Output Dry Contact 4 Output Dry Contact 5 Output Dry Contact 6	Select one of the following events as the setting for each output dry contact. <ol style="list-style-type: none"> 1. None 2. Load on inverter 3. Load on bypass 4. Load on battery 5. Battery low 6. Battery input abnormal 7. Battery test fail 8. Internal comm. fail 9. External parallel comm. fail (only applicable to parallel application) 10. Output overload 11. EPO activated 12. Load on manual bypass 13. Battery over temperature 14. Output voltage abnormal 15. Battery need replacement 16. Bypass over temperature 17. Bypass static switch fault 18. UPS over temperature 19. Battery breaker shunt trip 20. Backfeed protection 21. UPS general alarm 	Set up NO (normally open) or NC (normally closed) for each output dry contact.

7.10.7 General Setting

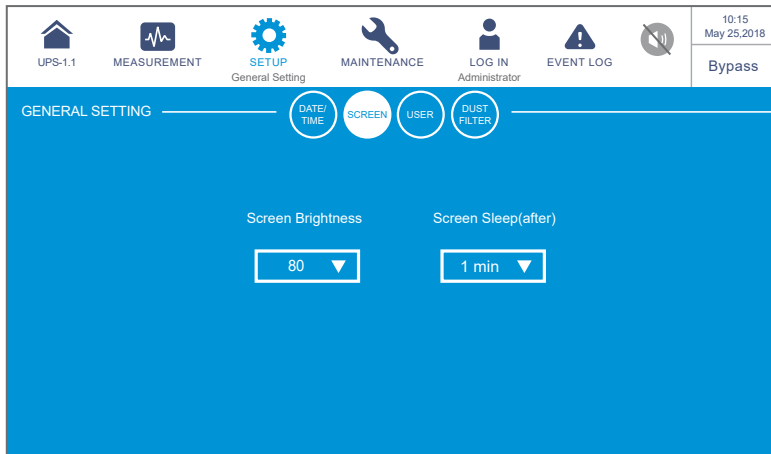
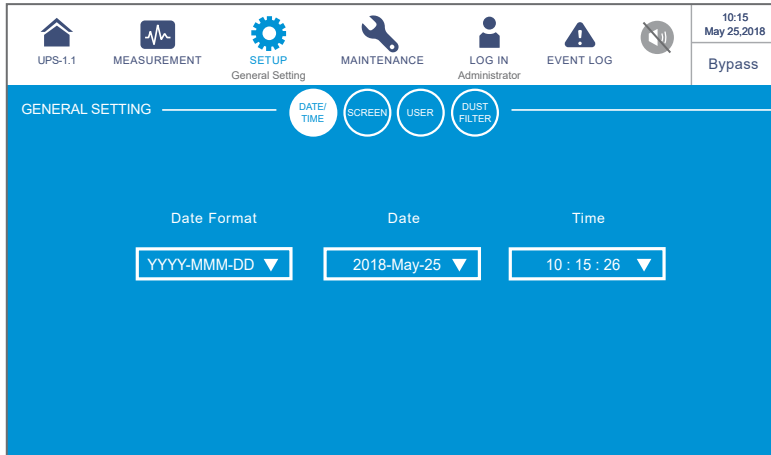

Path:  → General Setting

After entering the **GENERAL SETTING** screen (shown in the figure below), the following items can be set up.

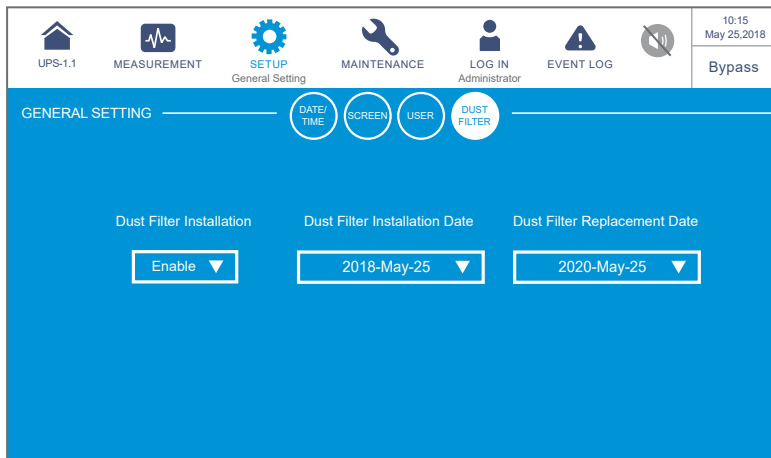
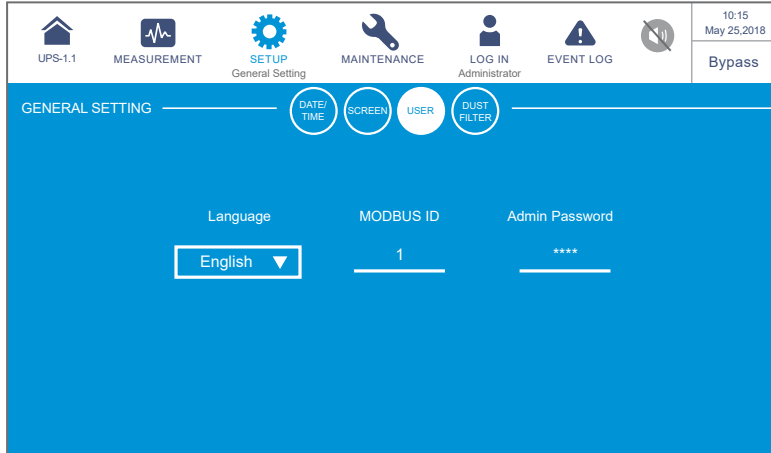



Item	Sub Item	Description
DATE/ TIME	Date Format	Select the date format.
	Date	Set up the date.
	Time	Set up the time.
SCREEN	Screen Brightness	Adjust the LCD display brightness (default: 80).
	Screen Sleep (after)	Set up the LCD backlight sleep time (default: 1 minute).
USER	Language	Set up the display language (default: English).
	MODBUS ID	Set up the MODBUS ID.
	Admin Password	Set up the administrator password (4 digits).

Item	Sub Item	Description
DUST FILTER	Dust Filter Installation	If you have installed any dust filter, please select ' Enable '; if not, please select ' Disable '.
	Dust Filter Installation Date	Set up the dust filter installation date.  NOTE: Only when you select ' Enable ' for ' Dust Filter Installation ' can you set up the ' Dust Filter Installation Date '.
	Dust Filter Replacement Date	Set up the dust filter replacement date. When the date is due, the red warning icon () will automatically appear in the upper right corner of the LCD, and the alarm message ' Replace Dust Filter ' will be displayed.  NOTE: Only when you select ' Enable ' for ' Dust Filter Installation ' can you set up the ' Dust Filter Replacement Date '.

7.10.8 IP Setting

Path:  → IP Setting

After entering the **IP SETTING** screen (shown in the figure below), the following items can be set up. These settings must be carried out by qualified service personnel. Please contact Delta customer service for assistance.

UPS-1.1	MEASUREMENT	SETUP IP Setting	MAINTENANCE	LOG IN Administrator	EVENT LOG	10:15 May 25, 2018
						Bypass
IP SETTING						
DHCP Client		IP Address	Subnet Mask	Gateway IP		
Enable ▼		172.16.190.64	255.255.254.0	172.16.191.254		
DNS 1 IP		DNS 2 IP	Search Domain	Host Name		
172.16.176.200		172.16.0.1	delta.corp	DELTA		

Item	Description
DHCP Client	Enable or disable the DHCP client.
IP Address	Set up the IP address.
Subnet Mask	Set up the subnet mask.
Gateway IP	Set up the gateway IP address.
DNS 1 IP	Set up the DNS server 1 IP address.
DNS 2 IP	Set up the DNS server 2 IP address.
Search Domain	Set up the search domain.
Host Name	Set up the host name.

7.10.9 Control

Path:  → **Control**

After entering the **CONTROL** screen (shown in the figure below), the following items can be set up. These settings must be carried out by qualified service personnel. Please contact Delta customer service for assistance.

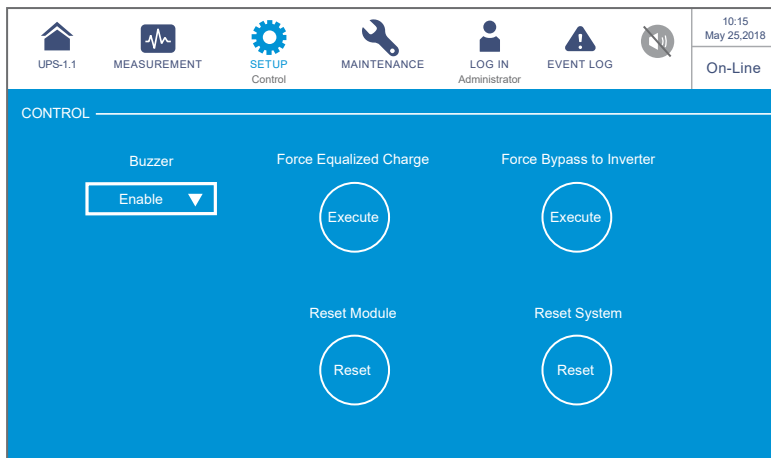

Item	Description
Buzzer	Enable or disable the buzzer.
Force Equalized Charge	Manually force the UPS to run in auto equalized charge mode to charge the batteries.
Force Bypass to Inverter	Manually force the UPS to switch from bypass to inverter when the inverter keeps staying in the soft-start status and is unable to transfer to on-line mode successfully.

Item	Description
Reset Module	Reset the power modules or not. In bypass mode, when you press the ON/ OFF button (⏻) to start up the UPS but the UPS does not respond, please select 'Reset' to reset the power modules. After the power modules are reset, please press the ON/ OFF button (⏻) to start up the UPS.
Reset System	Reset the system or not. In bypass mode, when you press the ON/ OFF button (⏻) to start up the UPS but the UPS does not respond, please select 'Reset' to reset the system. After the system is reset, please press the ON/ OFF button (⏻) to start up the UPS.

7.11 System Maintenance

7.11.1 Alarm Warning

Path 1:  → **Warning**

Path 2: When there is a warning, the buzzer icon (🔊) will light up in red, and the buzzer will make an alarm sound. click the warning icon (⚠️) to enter the **WARNING** screen.

After entering the **WARNING** screen (shown in figure below), you may use the (⏮️ ⏪️ ⏩️ ⏭️) buttons to inquire about warning logs or use the function key (1) to enter a specific page No. to check the warning logs. The system can store at maximum 200 warning logs.



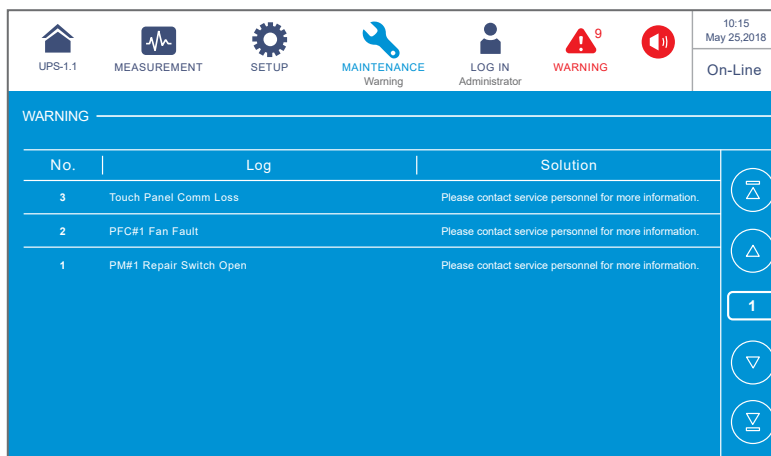

The **WARNING** screen also displays relevant solutions. For warning solutions, please refer to **10. Troubleshooting**.



7.11.2 Historical Event































Path:  → **Historical Event**































The **HISTORICAL EVENT** screen shown below provides each historical event's No., start date and time, code (red: serious; orange: minor; green: normal), location, and log description. You can click the icon () to magnify the entire historical event description.

You can use the buttons (   ) to check the historical event logs or use the function key () to enter a specific page No. to view the historical event logs.

The system can save up to 10000 historical event logs. The greater the event number is, the newer the event is. When the total number of historical event logs exceeds the storage capacity (up to 10000 entries), the oldest 500 historical event logs will be overwritten.

You can click the download button () to download the historical event logs. To clear the historical event logs, please refer to **7.11.5 Clear**.

 UPS-1.1  MEASUREMENT  SETUP  MAINTENANCE Historical Event  LOG IN Administrator  WARNING 						10:15 May 25, 2018
HISTORICAL EVENT 						On-Line
No. ▲	Start Date	Code	Location	Log		
187	2018-05-13 10:27:07	 3200-02	STS	Emergency PWR Off		    
186	2018-05-13 10:26:52	 2519-01	STS	CSU Aux Pwr #2 On Repair		
185	2018-05-13 10:26:52	 2518-01	STS	CSU Aux Pwr #1 On Repair		
184	2018-05-13 09:06:59	 0128-01	STS	Mains Input Freq Out Range		
183	2018-05-13 10:27:07	 5005-01	STS	No Output		
182	2018-05-13 10:26:52	 480A-01	STS	COM Card #2 Absent		
181	2018-05-13 10:26:36	 0100-01	STS	Mains Input Volt Out Range		
180	2018-05-13 09:16:45	 3200-01	STS	About Emergency PWR Off		

 UPS-1.1  MEASUREMENT  SETUP  MAINTENANCE Historical Event  LOG IN Administrator  WARNING 						10:15 May 25, 2018
HISTORICAL EVENT 						On-Line
No. ▲	Start Date	Code	Location	Log		
179	2018-05-13 09:06:59	 480A-01	STS	Battery Disconnected		    
178	2018-05-13 08:22:45	 1021-01	STS	Mains Input Freq Out Range		
177	2018-05-13 08:10:06	 2501-01	STS	Mains Input Volt Out Range		
176	2018-05-13 07:58:15	 501F-01	STS	UPS Soft Start		
175	2018-05-13 07:49:22	 5005-01	STS	No Output		
174	2018-05-13 07:35:10	 480A-01	STS	COM Card #2 Absent		
173	2018-05-13 07:25:25	 0100-01	STS	Mains Input Volt Out Range		
172	2018-05-13 07:15:02	 3200-01	STS	About Emergency PWR Off		

7.11.3 Statistics

Path:  MAINTENANCE → Statistics

After entering the **STATISTICS** screen (shown in the figure below), you may inquire about the following statistics.

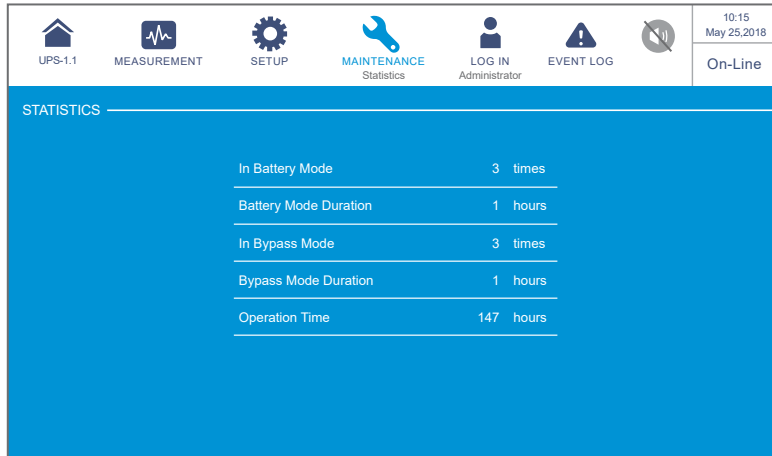

Item	Description
In Battery Mode	Means how many times that the UPS runs in battery mode.
Battery Mode Duration	Means how long the UPS runs in battery mode.
In Bypass Mode	Means how many times that the UPS runs in bypass mode.
Bypass Mode Duration	Means how long the UPS runs in bypass mode.
Operation Time	Means how long the UPS has operated.

To clear the statistics, please refer to **7.11.5 Clear**.

7.11.4 Test

Path:  MAINTENANCE → Test

After entering the **TEST** screen (shown in the figure below), you can perform a manual battery test.

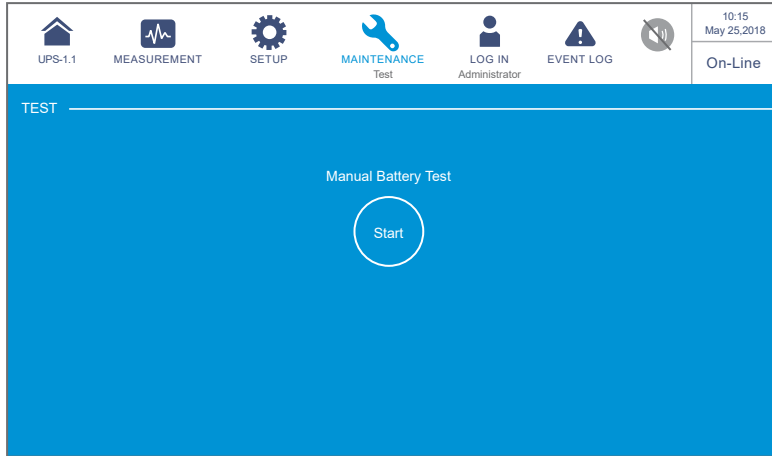

7.11.5 Clear

Path:  MAINTENANCE → Clear

After entering the **CLEAR** screen (shown in the figure below), you can clear the records of statistics, historical event and battery test result.

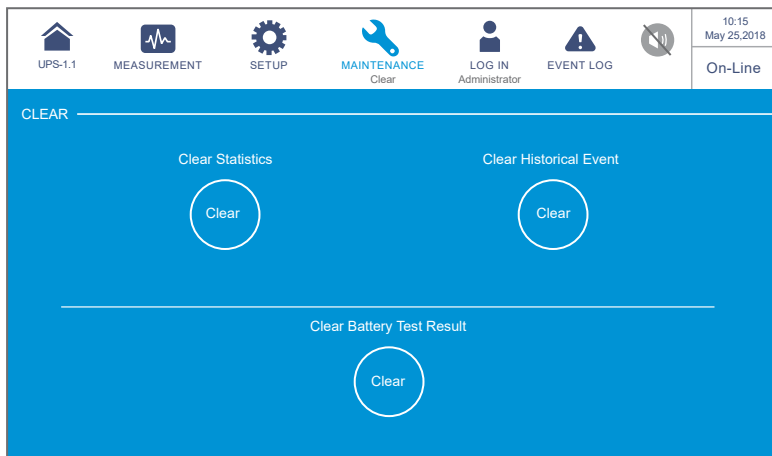

Item	Description
Clear Statistics	After selecting ' Clear ' and confirming clearance of statistics, all records of the statistics will be cleared. The clear action requires the Administrator password.
Clear Historical Event	After selecting ' Clear ' and confirming clearance of historical event logs, all historical event logs will be cleared. The clear action requires the Administrator password.
Clear Battery Test Result	After selecting ' Clear ' and confirming clearance of battery test result, the battery test result will be cleared. The clear action requires the Administrator password.



NOTE: The records of (1) statistics, (2) historical event and (3) battery test result provide important information for system analysis and maintenance. Do not clear any of them without the consent of qualified service personnel.

7.11.6 Advanced Diagnosis

Path:  MAINTENANCE → **Advanced Diagnosis**

After entering the **ADVANCED DIAGNOSIS** screen (shown in the figure below), you may check:

1. STS temperature, battery temperature, and fan speed of the system.
2. INV temperature and PFC temperature of a specific battery module.

UPS-1.1				MEASUREMENT				SETUP				MAINTENANCE Advanced Diagnosis				LOG IN Administrator				EVENT LOG				10:15 May 25, 2018			
ADVANCED DIAGNOSIS																SYSTEM				POWER MODULE							
STS Temp. (°C)				25				25				25															
Battery Temp. (°C)				25				25				25															
Fan Speed (rpm)				2300				2300				2300															

The screenshot shows the 'ADVANCED DIAGNOSIS' interface. On the left, a vertical rack of 9 Power Modules (PM 01 to PM 09) is shown with numbered callouts (01-09) pointing to each module. On the right, the 'Power Module 01' details are displayed in a table:

Power Module 01			
INV Temp. (°C)	30	30	30
PFC Temp. (°C)	35	35	35

7.11.7 Version & S/N

Path: MAINTENANCE → Version & S/N

After entering the **VERSION & S/N** screen (shown in the figure below), you may check and update the software version and serial number. For detailed information please refer to the table below.

The screenshot shows the 'VERSION & S/N' interface. At the top, there are navigation buttons for 'S/N', 'MAIN', 'INV', and 'PFC'. Below, a table lists the serial numbers for various components:

Component	Serial Number
System	Power Module 1 EA017700017W0
Touch Panel	Power Module 2 EA017700018W0
	Power Module 3 EA017700019W0
	Power Module 4 EA017700020W0
	Power Module 5 EA017700021W0
	Power Module 6 EA017700022W0
	Power Module 7 EA017700023W0
	Power Module 8 EA017700024W0
	Power Module 9 EA017700025W0

UPS-1.1 MEASUREMENT SETUP MAINTENANCE Version & S/N LOG IN Administrator EVENT LOG 10:15 May 25, 2018 Bypass

VERSION & S/N S/N MAIN INV PFC

	MCU	FPGA
COM #1	0H0017AR00.00.01	4A0000AD00.00.01
COM #2	0H0017AR00.00.01	4A0000AD00.00.01
System	0H0033AD00.01.00	4A0002AD00.00.01
Touch Panel	00.92	

Choose File

UPGRADE

UPS-1.1 MEASUREMENT SETUP MAINTENANCE Version & S/N LOG IN Administrator EVENT LOG 10:15 May 25, 2018 Bypass

VERSION & S/N S/N MAIN INV PFC

	MCU	FPGA	MCU	FPGA	
PM 01	0H0014AR00.00.00	4A001AR00.00.00	PM 02	0H0014AR00.00.00	4A001AR00.00.00
PM 03	0H0014AR00.00.00	4A001AR00.00.00	PM 04	0H0014AR00.00.00	4A001AR00.00.00
PM 05	0H0014AR00.00.00	4A001AR00.00.00	PM 06	0H0014AR00.00.00	4A001AR00.00.00
PM 07	0H0014AR00.00.00	4A001AR00.00.00	PM 08	0H0014AR00.00.00	4A001AR00.00.00
PM 09	0H0014AR00.00.00	4A001AR00.00.00			

Choose File

UPGRADE

UPS-1.1 MEASUREMENT SETUP MAINTENANCE Version & S/N LOG IN Administrator EVENT LOG 10:15 May 25, 2018 Bypass

VERSION & S/N S/N MAIN INV PFC

	MCU	FPGA	MCU	FPGA	
PM 01	0H0014AR00.00.00	4A001AR00.00.00	PM 02	0H0014AR00.00.00	4A001AR00.00.00
PM 03	0H0014AR00.00.00	4A001AR00.00.00	PM 04	0H0014AR00.00.00	4A001AR00.00.00
PM 05	0H0014AR00.00.00	4A001AR00.00.00	PM 06	0H0014AR00.00.00	4A001AR00.00.00
PM 07	0H0014AR00.00.00	4A001AR00.00.00	PM 08	0H0014AR00.00.00	4A001AR00.00.00
PM 09	0H0014AR00.00.00	4A001AR00.00.00			

Choose File

UPGRADE

Item	Sub Item	Description
S/N	System	Check the system's serial No.
	Touch Panel	Check the touch panel's serial No.
	Power Module#	Check a specific power module's serial No.
MAIN	COM#_ MCU/ FPGA	Check and update a specific COM's MCU or FPGA firmware version.
	System _ MCU/ FPGA	Check and update the system's MCU or FPGA firmware version.
	Touch Panel _ MCU/ FPGA	Check and update the touch panel's MCU or FPGA firmware version.
INV	PM #_ MCU/ FPGA	Check and update the MCU or FPGA firmware version of a specific power module's inverter.
PFC	PM #_ MCU/ FPGA	Check and update the MCU or FPGA firmware version of a specific power module's PFC.

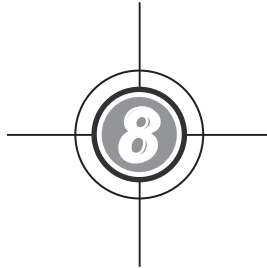

Optional Accessories

No.	Item	Function
1	60 ppi Dust Filter	Prevents dust from entering into the UPS to ensure UPS reliability and to prolong product life.
2	Relay I/O Card	Increases the quantity of dry contacts.
3	EnviroProbe 1000/ EnviroProbe 1100/ EnviroProbe 1200	Monitors temperature, humidity and other connected monitoring devices in a room environment. The EnviroProbe 1000/ 1100/ 1200 should work with either an SNMP card or an EMS2000.
4	Battery Cabinet Temperature Sensor Cable	Detects the temperature of an external battery cabinet connected to the UPS.
5	Parallel Cable (5-meter long)	Connects the parallel UPSs.
6	Parallel Cable (10-meter long)	Connects the parallel UPSs.
7	Battery Management System	Monitors (1) each battery's voltage, (2) each battery pack's voltage and charge/ discharging current, and (3) battery environment temperature.
8	Delta Maintenance Bypass Cabinet	Two options: 1. Equipped with an input switch, a manual bypass switch and an output switch. 2. Equipped with an input switch, a bypass switch, a manual bypass switch and an output switch.
9	Fuse Box for External Battery	When the UPS has a DC short circuit issue, the Fuse Box's internal fuses will automatically fuse to cut off the power connection between the UPS and the external battery cabinet, which achieves the function of power protection, avoids possible influence on other circuits, and decreases the possibility of other damages.



NOTE:

1. For detailed installation and operation of any accessory mentioned above, please refer to the **Quick Guide**, **User Guide**, or **Installation & Operation Guide** included in the package of the relevant optional accessory.
2. If you want to buy any accessory mentioned above, please contact your local dealer or customer service.



Maintenance

- **UPS**

1. UPS Cleaning:

Regularly clean the UPS, especially the slits, openings and filters, to ensure that the air freely flows into the UPS to avoid overheating. If necessary, use an air-gun to clean the slits and openings and replace the filters regularly to prevent any object from blocking or covering these areas.

2. UPS Regular Inspection:

- a. Monthly check the filters and yearly replace them.
- b. Regularly check the UPS every half year and inspect:
 - 1) Whether the UPS, LED indicators, and alarm function are operating normally.
 - 2) Whether the UPS works in bypass mode (normally, the UPS will work in normal mode). If yes, check if any error, overload, internal fault, etc. occurs.
 - 3) Whether battery voltage is normal. If the battery voltage is too high or too low, find the root cause.

- **Batteries**

The DPH series UPS uses sealed lead-acid batteries. The battery life depends on the temperature, the usage, and the charging/ discharging frequency. High temperature environments and high charging/ discharging frequency will quickly shorten the battery life. Please follow the suggestions below to ensure a normal battery lifetime.

1. Keep usage temperature between 15°C ~ 25°C.
2. When the UPS needs to be stored for an extended period of time, the batteries must be recharged once every three months and the charging time must not be less than 24 hours each time.

- **Fans**

Higher temperatures shorten fan life. When the UPS is running, please check if all of the fans work normally and make sure if the ventilation air can move freely around and through the UPS. If not, replace the fans.



NOTE: Please ask your local dealer or customer service for more maintenance information. Do not perform maintenance if you are not trained for it.



Troubleshooting

When you see the following alarm messages appear on the LCD, please follow the solutions shown below. If you see other alarm messages that are not listed in the table below, please contact Delta service personnel for assistance. Do not perform troubleshooting if you are not trained for it.

No.	Alarm Message	Possible Cause	Solution
1	Mains Input Volt/ Freq Out Range	<ol style="list-style-type: none"> 1. The input breaker or switch is turned off. 2. The main AC source's voltage or frequency is abnormal. 	<ol style="list-style-type: none"> 1. Please check if the input breaker or switch is turned off or not. If yes, please turn it on. 2. Please check if the main AC source's voltage or frequency is abnormal or not. If yes, please wait for the main AC source to be restored. 3. If the alarm message still exists after the solutions mentioned above have been executed, please contact service personnel.
2	Mains Input Volt Phase Seq Abnormal	The wiring is incorrect.	Please check the wiring and phase sequence of the main AC source, and contact service personnel for assistance.
3	Mains Input Breaker Off	The input breaker or switch is turned off.	<ol style="list-style-type: none"> 1. Please check if the input breaker or switch is turned off or not. If yes, please turn it on. 2. If the alarm message still exists after the solution mentioned above has been executed, please contact service personnel.
4	Bypass Input Volt Out Range	<ol style="list-style-type: none"> 1. The bypass breaker or switch is turned off. 2. The bypass AC source's voltage is abnormal. 	<ol style="list-style-type: none"> 1. Please check if the bypass breaker or switch is turned off or not. If yes, please turn it on. 2. Please check if the bypass AC source's voltage is abnormal or not. If yes, please wait for the bypass AC source to be restored. 3. If the alarm message still exists after the solutions mentioned above have been executed, please contact service personnel.
5	Bypass Input Freq Out Range	<ol style="list-style-type: none"> 1. The bypass breaker or switch is turned off. 2. The bypass AC source's frequency is abnormal. 	<ol style="list-style-type: none"> 1. Please check if the bypass breaker or switch is turned off or not. If yes, please turn it on. 2. Please check if the bypass AC source's frequency is abnormal or not. If yes, please wait for the bypass AC source to be restored. 3. If the alarm message still exists after the solutions mentioned above have been executed, please contact service personnel.

No.	Alarm Message	Possible Cause	Solution
6	Bypass Input Volt Phase Seq Abnormal	The wiring is incorrect.	Please check the wiring and phase sequence of the bypass AC source, and contact service personnel for assistance.
7	Bypass Volt Out ECO Range	The bypass AC source's voltage or frequency exceeds the range for ECO mode.	Please check the bypass AC source's voltage or frequency. If it is abnormal, please wait for the bypass AC source to be restored.
8	Bypass Breaker Off	For single input application, the input breaker or switch is turned off.	<ol style="list-style-type: none"> 1. Please check if the input breaker or switch is turned off or not. If yes, please turn it on. 2. If the alarm message still exists after the solution mentioned above has been executed, please contact service personnel.
		For dual input application, the bypass breaker or switch is turned off.	<ol style="list-style-type: none"> 1. Please check if the bypass breaker or switch is turned off or not. If yes, please turn it on. 2. If the alarm message still exists after the solution mentioned above has been executed, please contact service personnel.
9	Bypass STS Over Heat Warning	Heat dissipation is poor or components are damaged.	<ol style="list-style-type: none"> 1. Check if any foreign matter blocks the fans or air inlet. If yes, remove the foreign matter. 2. Decrease some loads. 3. If the alarm message still exists after the solutions mentioned above have been executed, please contact service personnel.
10	Bypass STS Fault	The bypass static switch or its driving circuit is abnormal.	Please contact service personnel for assistance.
11	Battery End of Discharge Imminent	The battery voltage is lower than the alarm value.	If there is no bypass power feeding to the system, please shut down the connected loads in accordance with normal procedures as soon as possible.
12	Battery End Of Discharge	The battery voltage is lower than the End-of-Discharge setup value.	If there is no bypass power feeding to the system, please shut down the connected loads in accordance with normal procedures as soon as possible.
13	Battery Over Charged	The charger is abnormal.	Please contact service personnel for assistance.

No.	Alarm Message	Possible Cause	Solution
14	Battery Disconnected	<ol style="list-style-type: none"> The batteries are not connected. The battery breaker is turned off. 	<ol style="list-style-type: none"> Please check if the batteries are properly connected. Please check if the battery breaker is turned off or not. If yes, please turn it on. If the alarm message still exists after the solutions mentioned above have been executed, please contact service personnel.
15	Battery Life Expired"	<ol style="list-style-type: none"> The battery replacement date is due. The system date is wrongly set. 	<ol style="list-style-type: none"> Please check if the battery replacement date is due or not. If yes, please contact service personnel for assistance. Please check the setting of the system date. If there is any error, please correct it.
16	Battery Reversed	The battery wiring is wrong.	Check the battery wiring. If there is any error or abnormality, please contact service personnel for assistance.
17	Battery Test Fail	The battery wiring is wrong or battery abnormalities exist.	Check the batteries. If wrong battery wiring or battery abnormalities exist, please contact service personnel for assistance.
18	Battery Ground Fault	The battery grounding is wrong or the input dry contact configuration is wrong.	<ol style="list-style-type: none"> Check if the battery wiring is normal or not. Check if the input dry contact configuration is normal or not. If the alarm message still exists after the solutions mentioned above have been executed, please contact service personnel.
19	Battery Breaker OFF	The battery breaker is turned off.	<ol style="list-style-type: none"> Please check if the external battery breaker is turned off or not. If yes, please turn it on. If the alarm message still exists after the solution mentioned above has been executed, please contact service personnel.
20	Battery Over Temperature	The battery temperature is too high or the batteries are abnormal.	<ol style="list-style-type: none"> Improve ventilation to reduce the battery temperature. Check if the batteries are abnormal or not. If yes, please contact service personnel for assistance.
21	Battery Under Temperature	The battery temperature is too low or the batteries are abnormal.	<ol style="list-style-type: none"> Check the battery constant temperature equipment. Check if the batteries are abnormal or not. If yes, please contact service personnel for assistance.

No.	Alarm Message	Possible Cause	Solution
22	Output Overload Warning	The connected loads exceed the rated value.	Please decrease the loads.
23	Output Overload Shutdown	The connected loads exceed the rated value for a long time.	<ol style="list-style-type: none"> 1. After overload shutdown, the connected loads will be supplied by the bypass. Please decrease the loads to let the system re-start automatically. 2. If the alarm message still exists after the solution mentioned above has been executed, please contact service personnel.
24	INV Volt Abnormal	The inverter's output voltage is too high or too low.	Please contact service personnel for assistance.
25	INV Over Current Warning	The inverter's output current is too high.	Please contact service personnel for assistance.
26	INV Over Current Shutdown	The inverter's output current is too high.	Please contact service personnel for assistance.
27	INV Output Current Unbalance	The connected loads are abnormal or the power modules are damaged.	Please contact service personnel for assistance.
28	Output Breaker Off	The output breaker or switch is off.	<ol style="list-style-type: none"> 1. Please check if the output breaker or switch is turned off or not. If yes, please turn it on. 2. If the alarm message still exists after the solution mentioned above has been executed, please contact service personnel.
29	PM Redundancy Loss	The connected loads exceed the redundancy setting.	<ol style="list-style-type: none"> 1. Please reduce the loads. 2. Please reset the power module redundancy setting. Please refer to 7.10.3 Output Setting.
30	System Fan Fault	The system's fan components are damaged.	Please contact service personnel for assistance.
31	STS Module Fan Abnormal	The STS module's fan components are damaged.	Please contact service personnel for assistance.

No.	Alarm Message	Possible Cause	Solution
32	PM #n Fan Abnormal	The #n power module's fan components are damaged.	Please contact service personnel for assistance.
33	Replace Dust Filter	The filter replacement date is due.	Please contact service personnel for assistance.
34	Parallel Unit Config Incompatible - AC In Type	There are conflicts between the parallel UPS units' AC input settings.	Check if the AC input settings among the parallel UPS units are correct or not, and contact service personnel for assistance.
35	Parallel Unit Config Incompatible - Output Type	There are conflicts between the parallel UPS units' output settings.	Check if the output settings among the parallel UPS units are correct or not, and contact service personnel for assistance.
36	Parallel Unit Config Incompatible - Bat Type	<ol style="list-style-type: none"> 1. There are conflicts between the parallel UPS units' battery settings. 2. The input dry contact setting for the generator is abnormal. 	<ol style="list-style-type: none"> 1. Check if the battery settings among the parallel UPS units are correct or not, and contact service personnel for assistance. 2. Check the input dry contact setting.
37	EXT Parallel Comm Loss	The parallel cable is loose or the circuit board has abnormalities.	Check if the parallel cable is firmly connected or not, and contact service personnel for assistance.
38	Local Comm Loss	The system's internal communication cable is loose or the circuit board has abnormalities.	Please contact service personnel for assistance.
39	EXTCAN Bus Abnormal - Physical	The parallel cable is loose or the circuit board has abnormalities.	Check if the parallel cable is firmly connected or not, and contact service personnel for assistance.
40	INTCAN Bus Abnormal - Physical	The system's internal communication cable is loose or the circuit board has abnormalities.	Please contact service personnel for assistance.
41	MONCAN Abnormal - Physical	The system's internal communication cable is loose or the circuit board has abnormalities.	Please contact service personnel for assistance.

No.	Alarm Message	Possible Cause	Solution
42	PFC #n MONCAN Comm Loss	The circuit board has abnormalities.	Please contact service personnel for assistance.
43	Parallel IO Abnormal	The system's internal communication cable is loose or the circuit board has abnormalities.	Please contact service personnel for assistance.
44	INV #n PLL Bus Abnormal	The main AC source's voltage is changed or the circuit board has abnormalities.	Please confirm if the main AC source's voltage is abnormal or not. If yes, please wait for the main AC source to be restored to normal. If no, please contact service personnel for assistance.
45	System Aux Pwr Fault	The #n auxiliary power card has abnormalities.	Please contact service personnel for assistance.
46	CSU Aux Pwr #n On Repair	The #n auxiliary power card is not inserted.	Please contact service personnel for assistance.
47	COM Card #n Absent	The #n parallel communication card is abnormal.	Please contact service personnel for assistance.
48	PM#n Abnormal Absent	The #n power module is abnormally removed or the power outage occurs.	Please contact service personnel for assistance.
49	STS Card FPGA Config Abnormal	The system control card is abnormal.	Please contact service personnel for assistance.
50	Soft Start Fail	The #n power module is abnormal.	Please contact service personnel for assistance.
51	PM #n PFC Input Current Unbalance	The #n power module is abnormal.	Please contact service personnel for assistance.
52	PFC #n Over Heat Warning	The fans are abnormal.	1. Check if any foreign matter blocks the fans or not. If yes, remove the foreign matter. 2. Contact service personnel for assistance.

No.	Alarm Message	Possible Cause	Solution
53	PFC #n Over Heat Shutdown	The fans are abnormal.	1. Check if any foreign matter blocks the fans or not. If yes, remove the foreign matter. 2. Contact service personnel for assistance.
54	PFC #n DC Bus Over Shutdown	The #n power module is abnormal.	Please contact service personnel for assistance.
55	PFC #n DC Bus Under Shutdown	The #n power module is abnormal.	Please contact service personnel for assistance.
56	INV #n Over Heat Warning	The fans are abnormal.	1. Check if any foreign matter blocks the fans or not. If yes, remove the foreign matter. 2. Contact service personnel for assistance.
57	INV #n Over Heat Shutdown	The fans are abnormal.	1. Check if any foreign matter blocks the fans or not. If yes, remove the foreign matter. 2. Contact service personnel for assistance.
58	INV #n DC Bus Over Shutdown	The #n power module is abnormal.	Please contact service personnel for assistance.
59	INV #n DC Bus Under Shutdown	The #n power module is abnormal.	Please contact service personnel for assistance.
60	PFC Fuse Open	The #n power module is abnormal.	Please contact service personnel for assistance.
61	Battery Fuse Open	The #n power module is abnormal.	Please contact service personnel for assistance.
62	Charger Fuse Open	The #n power module is abnormal.	Please contact service personnel for assistance.
63	INV #N Output Fuse Open	The #n power module is abnormal.	Please contact service personnel for assistance.
64	Output Relay Fault	The #n power module is abnormal.	Please contact service personnel for assistance.
65	PM Repair Switch Open	The #n power module's switch is in the OFF status.	1. Please turn on the #n power module's switch. 2. If the alarm message still exists after the solution mentioned above has been executed, please contact service personnel.

No.	Alarm Message	Possible Cause	Solution
66	Over OTP Auto Recover Limit	The #n power module activates its own abnormal protection mechanism to re-start automatically more than 3 times.	Please contact service personnel for assistance.
67	Over DC Bus OVP Auto Recover Limit	The #n power module activates its own abnormal protection mechanism to re-start automatically more than 3 times.	Please contact service personnel for assistance.
68	Over OCP Auto Recover Limit	The #n power module activates its own abnormal protection mechanism to re-start automatically more than 3 times.	Please contact service personnel for assistance.
69	INV Volt Abnormal	<ol style="list-style-type: none"> 1. The output to the connected loads is abnormal. 2. The #n power module's output voltage is too high or too low. 	Please contact service personnel for assistance.
70	PWM Carrier Fault	<ol style="list-style-type: none"> 1. The system's internal communication cable is loose. 2. The circuit board has abnormalities. 	Please contact service personnel for assistance.
71	INV PLL Ref Bus Abnormal	<ol style="list-style-type: none"> 1. The system's internal communication cable is loose. 2. The circuit board has abnormalities. 	Please contact service personnel for assistance.
72	Emergency Pwr Of	The EPO button is pressed.	<ol style="list-style-type: none"> 1. Please confirm if the EPO button is pressed or not. If yes, restart the UPS in accordance with the normal start-up procedures after the relevant abnormalities are eliminated. 2. If the alarm message still exists, please contact service personnel for assistance.

No.	Alarm Message	Possible Cause	Solution
73	Load on manual bypass	The manual bypass breaker or switch is turned on.	<ol style="list-style-type: none"> 1. Please confirm if the manual bypass breaker or switch is turned on or not. If yes, restart the UPS in accordance with the normal start-up procedures after the relevant abnormalities are eliminated. 2. If the alarm message still exists, please contact service personnel for assistance.
74	Charger Volt Abnormal	The charger is abnormal.	Please contact service personnel for assistance.
75	Charger Current Abnormal	The charger is abnormal.	Please contact service personnel for assistance.
76	Charger Over Heat warning	The fans are abnormal.	<ol style="list-style-type: none"> 1. Check if any foreign matter blocks the fans or not. If yes, remove the foreign matter. 2. Contact service personnel for assistance.
77	Charger Over Heat Shutdown	The fans are abnormal.	<ol style="list-style-type: none"> 1. Check if any foreign matter blocks the fans or not. If yes, remove the foreign matter. 2. Contact service personnel for assistance.



NOTE:

If the alarm still exists after the above possible causes are eliminated, please contact your dealer or customer service.

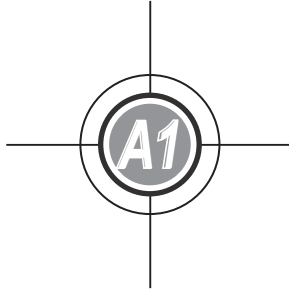

Technical Specifications

Model		DPH			
UPS Capacity		200kVA/ 200kW	300kVA/ 300kW	400kVA/ 400kW	500kVA/ 450kW
Power Module Q'ty		4	6	8	9
Input	Nominal Voltage	220/380 Vac, 230/400 Vac, 240/ 415 Vac (3Φ4W + G)			
	Voltage Range	176 ~ 276Vac (full load)			
	Current Harmonic Distortion	≤ 3% *1			
	Power Factor	> 0.99			
	Frequency Range	40 ~ 70 Hz			
Output	Voltage	220/380 Vac, 230/400 Vac, 240/ 415 Vac (3Φ4W + G)			
	Voltage Harmonic Distortion	≤ 0.5% (linear load)			
	Power Factor	1/0.9 (adjustable)			
	Frequency	50/60 Hz			
	Overload Capability	≤ 125% : 10 minutes ; ≤ 150% : 1 minute; > 150%: 1 second			
Display		10" Touch Panel			
Interface	Standard	External battery temperature dry contact x 4, External switch/ breaker status dry contact x 4, Output dry contact x 6, Input dry contact x 4, Parallel port x 4, USB type A x 2, USB type B x 1, RS-232 port x 1, MODBUS port x 1, BMS (RJ45) x 1, Ethernet x 1, SMART slot x 1, REPO x 1			
Efficiency	Online Mode	up to 96.5%			
	ECO Mode	99%			
Battery	Nominal Voltage	±240 Vdc			
	Charge Voltage	±272 Vdc (adjustable from 204 Vdc to 312 Vdc)			
	Protection of Battery Deep Discharge	Yes			

Model		DPH			
UPS Capacity		200kVA/ 200kW	300kVA/ 300kW	400kVA/ 400kW	500kVA/ 450kW
Environment	Operating Altitude	1000 meters (without derating)			
	Operating Temperature	0 ~ 40°C			
	Relative Humidity	95% (non-condensing)			
	Audible Noise	<65 dBA*2	<75 dBA*2	<80 dBA*2	<85 dBA*2
	IP Degree of Protection	IP 20			
Others	Parallel Redundancy	Yes (up to 8 units)			
	Emergency Power Off	Yes (remote as default; local as optional)			
	Battery-start	Yes			
Physical	Dimensions (W x D x H)	600 x 1100 x 2000 mm			
	Weight	UPS: 317 kg (without power modules)			
		Power module (optional): 36 kg			
		461 kg	533 kg	605 kg	641 kg



NOTE:

1. *1 : When input vTHD is <1%.
2. *2 : At a distance of 1 meter in front of the UPS.
3. Please refer to the rating label for the safety rating.
4. All specifications are subject to change without prior notice.

The logo consists of a central circle containing the text 'A2'. This circle is surrounded by a larger, fainter circle. Four thin lines extend from the center of the circles towards the top, bottom, left, and right edges of the page.

Warranty

Seller warrants this product, if used in accordance with all applicable instructions, to be free from original defects in material and workmanship within the warranty period. If the product has any failure problem within the warranty period, Seller will repair or replace the product at its sole discretion according to the failure situation.

This warranty does not apply to normal wear or to damage resulting from improper installation, operation, usage, maintenance or irresistible force (i.e. war, fire, natural disaster, etc.), and this warranty also expressly excludes all incidental and consequential damages.

Maintenance service for a fee is provided for any damage out of the warranty period. If any maintenance is required, please directly contact the supplier or Seller.



WARNING:

The individual user should take care to determine prior to use whether the environment and the load characteristic are suitable, adequate or safe for the installation and the usage of this product. The User Manual must be carefully followed. Seller makes no representation or warranty as to the suitability or fitness of this product for any specific application.

No. 501325560102
Version : V 1.2
UM Date : 2018_06_01



5013255601