

The power behind competitiveness

Delta UPS - Modulon Family

DPH Series, Three Phase
25-75 kVA

User Manual

SAVE THIS MANUAL

This manual contains important instructions and warnings that you should follow during the installation, operation, storage and maintenance of this product. Failure to heed these instructions and warnings will void the warranty.

Copyright © 2020 by Delta Electronics Inc. All Rights Reserved. All rights of this User Manual ("Manual"), including but not limited to the contents, information, and figures are solely owned and reserved by Delta Electronics Inc. ("Delta"). The Manual can only be applied to the operation or the use of this product. Any disposition, duplication, dissemination, reproduction, modification, translation, extraction, or usage of this Manual in whole or in part is prohibited without the prior written permission of Delta. Given that Delta will continuously improve and develop the product, changes may be made to the information in this Manual at any time without obligation to notify any person of such revision or changes. Delta will make all possible efforts to secure the accuracy and the integrity of this Manual. Delta disclaims any kinds or forms of warranty, guarantee, or undertaking, either expressly or implicitly, including but not limited to the completeness, faultlessness, accuracy, non-infringement, merchantability or fitness for a particular purpose of the Manual.

Table of Contents

1.	Important Safety Instructions	1-1
1.1	Safety Instructions	1-2
1.2	Glossary of Symbols	1-5
1.3	Standard Compliance	1-6
2.	Introduction	2-1
2.1	General Overview	2-2
2.2	Package Inspection	2-2
2.3	Functions & Features	2-4
2.4	Exterior	2-5
2.4.1	Mechanism Data	2-6
2.4.2	Other Views	2-6
2.5	Control Panel	2-8
2.5.1	LED Indicators	2-8
2.5.2	ON, OFF, and EPO Buttons	2-8
2.5.3	LCD Display	2-9
2.5.4	Function Keys	2-9
2.6	Internal Mechanisms	2-10
2.6.1	Breakers	2-10
2.6.2	Wiring Terminal Block	2-10
2.6.3	Modules	2-12
2.6.4	Battery Fuses	2-13
3.	Operation Modes	3-1
3.1	Normal Mode (Single)	3-2
3.2	Battery Mode (Single)	3-3
3.3	Bypass Mode (Single)	3-3
3.4	Manual Bypass Mode (Single)	3-4
3.5	ECO Mode (For Single Unit Only)	3-5
3.6	Normal Mode (Parallel)	3-5

3.7	Battery Mode (Parallel)-----	3-6
3.8	Bypass Mode (Parallel)-----	3-7
3.9	Manual Bypass Mode (Parallel)-----	3-8
3.10	Hot Standby Redundancy-----	3-10
3.11	Common Battery-----	3-11

4. Communication Interfaces ----- 4-1

4.1	LCD Port-----	4-2
4.2	Output Dry Contacts-----	4-3
4.3	Input Dry Contacts-----	4-5
4.4	Battery Dry Contacts-----	4-6
4.5	System Communication Port-----	4-7
4.6	DIP Switches-----	4-7
4.7	LCM Port-----	4-7
4.8	Parallel Ports-----	4-7
4.9	Smart Slots-----	4-7

5. Installation and Wiring ----- 5-1

5.1	Before Installation-----	5-2
5.2	Installation Environment-----	5-2
5.3	Transportation-----	5-3
5.4	Fixing the UPS-----	5-4
5.5	Wiring-----	5-5
5.5.1	Pre-wiring Warnings-----	5-5
5.5.2	Single Input/ Dual Input Modification-----	5-8
5.5.3	Single Unit Wiring-----	5-8
5.5.4	Parallel Units Wiring-----	5-12
5.6	External Battery Cabinet-----	5-15
5.6.1	Usage Warnings-----	5-15
5.6.2	External Battery Cabinet Wiring-----	5-18
5.7	Battery Module-----	5-19
5.7.1	Battery Module Installation/ Removal-----	5-20

5.8	Battery Alarm -----	5-22
5.9	Other Modules-----	5-23
5.9.1	Power Module (Optional ; at maximum three) -----	5-23
5.9.2	STS Module -----	5-27
5.9.3	Control Module -----	5-30
5.9.4	Rack-mount PDC (optional; at maximum one) -----	5-31
6.	UPS Operation-----	6-1
6.1	Pre-operation Warnings-----	6-2
6.2	Single Unit Operation Procedures-----	6-4
6.2.1	Normal Mode Start-up Procedures (Single) -----	6-4
6.2.2	Battery Mode Start-up Procedures (Single) -----	6-6
6.2.3	Bypass Mode Start-up Procedures (Single)-----	6-7
6.2.4	Manual Bypass Mode Start-up Procedures (Single Unit)-----	6-8
6.2.5	Normal Mode Turn-off Procedures (Single) -----	6-12
6.2.6	Battery Mode Turn-off Procedures (Single) -----	6-12
6.2.7	Bypass Mode Turn-off Procedures (Single) -----	6-13
6.2.8	Manual Bypass Mode Turn-off Procedures (Single) -----	6-14
6.3	Parallel Unit Operation Procedures -----	6-14
6.3.1	Normal Mode Start-up Procedures (Parallel) -----	6-15
6.3.2	Battery Mode Start-up Procedures (Parallel) -----	6-17
6.3.3	Bypass Mode Start-up Procedures (Parallel) -----	6-19
6.3.4	Manual Bypass Mode Start-up Procedures (Parallel) -----	6-20
6.3.5	Normal Mode Turn-off Procedures (Parallel)-----	6-25
6.3.6	Battery Mode Turn-off Procedures (Parallel)-----	6-27
6.3.7	Bypass Mode Turn-off Procedures (Parallel) -----	6-29
6.3.8	Manual Bypass Mode Turn-off Procedure (Parallel) -----	6-30
7.	LCD Display & Settings -----	7-1
7.1	LCD Display Hierarchy -----	7-2
7.2	LCD Display & Function Keys-----	7-3
7.3	Password Entry -----	7-6
7.4	Main Screen -----	7-6

7.5	Main Menu -----	7-10
7.6	Check System Readings -----	7-11
7.7	UPS Configurations -----	7-12
7.7.1	Bypass Setup -----	7-12
7.7.2	Output Setup -----	7-12
7.7.3	Battery Setup -----	7-13
7.7.4	Charger Setup -----	7-14
7.7.5	Parallel Setup -----	7-14
7.7.6	Control & Test Setup -----	7-15
7.7.7	Local Setup -----	7-16
7.8	System Maintenance -----	7-16
7.8.1	Check/ Clear Event Log -----	7-16
7.8.2	Check/ Clear Statistics -----	7-17
7.8.3	Check Serial Number and Firmware Version -----	7-17
7.8.4	Change Display Language -----	7-18
7.8.5	Reset Module -----	7-18
7.8.6	Reset LCD Display -----	7-19
7.8.7	Force to Start Inverter -----	7-19
7.8.8	Check the STS Module and the Power Module Status -----	7-20
7.8.9	Upgrade Firmware -----	7-21
7.9	Power Distribution -----	7-21
7.9.1	RPDC METER -----	7-21
7.9.2	RPDC BRANCH -----	7-22
8.	Optional Accessories -----	8-1
9.	Maintenance -----	9-1
10.	Troubleshooting -----	10-1
	Appendix 1 : Technical Specifications -----	A1-1
	Appendix 2 : Warranty -----	A2-1

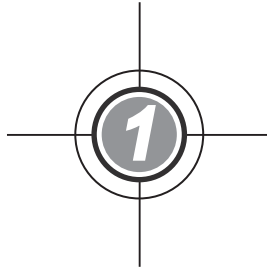

Important Safety Instructions

- 1.1 Safety Instructions
- 1.2 Glossary of Symbols
- 1.3 Standard Compliance

1.1 Safety Instructions



RISK OF ELECTRIC SHOCK!

- Do not open or remove the cover of the UPS to avoid high voltage electric shock. Only authorized Delta engineers or service personnel can do so for installation or maintenance. If you want to open or remove the cover, do it only under the supervision of authorized Delta engineers or service personnel.
- The risk of dangerous high voltage is possible when batteries are still connected to the UPS even though the UPS is disconnected from AC power sources. Before maintenance, do not forget to cut off the battery source.
- A battery can present a risk of electric shock and high short-circuit current. The following precautions should be observed before replacement of batteries:
 1. Remove watches, rings, or other metal objects.
 2. Use tools with insulated handles.
 3. Wear insulating gloves and boots.
 4. Do not lay tools or metal parts on the top of batteries.
 5. Disconnect the charging source prior to connecting or disconnecting the batteries' terminals.
- Before applying electrical power to the UPS, make sure the UPS is grounded to avoid a possible risk of current leakage.
- Before working on the UPS's internal circuits, cut off the input power and the battery source.



DANGER!

- Do not dispose of the battery or batteries in a fire. The batteries may explode.
- Do not open or damage the battery or batteries. The released electrolyte is harmful to the skin and eyes and may be toxic.
- Install the UPS in a well-ventilated indoor area, away from excess moisture, heat, dust, flammable gas or explosives.

**WARNING!**

- Follow the IEC 60364-4-42 standard to install the UPS.
- Connect the UPS's output to either critical loads or a rack-mount PDC (optional). Please only choose one application. You can install at maximum one rack-mount PDC in one UPS.
- If the UPS's output connects to the rack-mount PDC (optional; at maximum one), please refer to the rack-mount PDC's user manual for relevant information about the rack-mount PDC's installation, wiring and operation.
- For battery usage, the UPS can use either the external battery cabinet (at maximum four) or the battery module (optional; at maximum four). The UPS cannot use them at the same time. Please only choose one application. For more information, please refer to **5.6 External Battery Cabinet & 5.7 Battery Module**.
- When $50\text{kVA} < \text{total load} \leq 75\text{kVA}$, the UPS must use the external battery cabinet (at maximum four) but not the battery module.
When $25\text{kVA} < \text{total load} \leq 50\text{kVA}$, the UPS can use either the external battery cabinet (at maximum four) or at least four battery modules (a battery module includes four battery boxes).
When the total load is $\leq 25\text{kVA}$, the UPS can use either the external battery cabinet (at maximum four) or at least two battery modules (a battery module includes four battery boxes).
When the UPS uses four battery modules(optional) and the total load is 50kVA, the batteries can supply power for at least 5 minutes.
- Common battery is only applicable for the external battery cabinet (at maximum four) but not for the battery module.
- Leave adequate space around all sides of the UPS for proper ventilation and maintenance. Please refer to **5.2 Installation Environment**.
- The installation of protective devices is highly recommended when the UPS is connected to power sources and critical loads.
- The protective devices connecting to the UPS must be installed near the UPS and must be easily accessible for operation.
- The external slits and openings in the UPS are provided for ventilation. To ensure reliable operation of the UPS and to protect the UPS from overheating, these slits and openings must not be blocked or covered. Do not insert any object into the slits and openings that may hinder ventilation.









- To protect the UPS from overheating, wiring must not block or cover any fans of the Power Module (optional; at maximum three) and the rack-mount PDC (optional; at maximum one).
- If the UPS is supplied by a source whose neutral is grounded, the protective device installed as UPS input protection must be a 3-pole type. If the UPS is supplied by a source whose neutral is not grounded, the protective device installed as UPS input protection must be a 4-pole type.
- Do not put beverages on the UPS, external battery cabinet or any other accessory associated with the UPS.
- Before applying power to the UPS, you must allow it to adjust to room temperature (20°C ~ 25°C) for at least one hour to avoid moisture condensing inside the UPS.
- The UPS is electrical equipment that runs 24 hours continuously. To ensure its normal lifetime, regular maintenance of the UPS and batteries is of vital importance and necessary.
- Some components like batteries, power capacitors, and fans will become worn-out due to long-term usage, and this will increase the risk of UPS failure. To replace and maintain the components, please contact Delta customer service department.
- The UPS can be used to power computers and associated peripheral devices, such as monitors, modems, cartridge tape drives, external hard drives, etc. If you want to connect inductive or capacitive loads to the UPS, it needs derating. Please contact Delta service personnel for derating information.
- If the UPS needs to be stored prior to installation, it should be placed in a dry indoor area. The allowable storage temperature is below 40°C and relative humidity is below 90%.





HANDLING!

- The UPS is **HEAVY!** Please use sufficient manpower (at least six people) and equipment (e.g. forklift) to carefully move the UPS from pallet to ground. Please pay attention to the movement of UPS's casters to avoid accidents.
- The casters are designed to move on level ground. Do not move the UPS on an uneven surface. This might cause damage to the casters or tip the UPS which could damage the unit.

1.2 Glossary of Symbols

No.	Symbol	Description
1	R	R-phase
2	S	S-phase
3	T	T-phase
4	N	Neutral
5		Grounding (Protective earthing conductor)
6		Bonded to ground
7	+	Positive battery terminal
8	-	Negative battery terminal
9	ON	ON button
10	OFF	OFF button
11		EPO button
12	NORMAL	Normal LED indicator
13	BATTERY	Battery LED indicator
14	BYPASS	Bypass LED indicator
15	FAULT	Fault LED indicator
16		Return/ Cancel key
17		Enter key
18	F1	Function key F1
19	F2	Function key F2
20		Moves up/ goes back to previous page
21		Moves down/ goes to next page
22		Moves left
23		Moves right

No.	Symbol	Description
24	+	Increases number
25	-	Decreases number
26		Module latch – locked
27		Module latch – open



NOTE: For information about the meaning of each symbol shown on the LCD, please refer to **7.2 LCD Display & Settings**.

1.3 Standard Compliance

- EN 62040-1
- EN 62040-2 Category C3
- IEC 61000-4-2 Level 4
- IEC 61000-4-3 Level 3
- IEC 61000-4-4 Level 4
- IEC 61000-4-5 Level 4
- IEC 61000-4-6

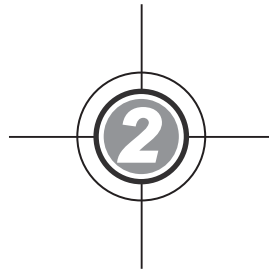

Introduction

2.1 General Overview

2.2 Package Inspection

2.3 Functions & Features

2.4 Exterior

2.5 Control Panel

2.6 Internal Mechanisms

2.1 General Overview

The DPH series UPS is a three-phase, four-wire online UPS designed for applications in large-scale data centers, factories and other facilities. With its innovative IGBT (Insulated Gate Bipolar Transistor) architecture, the UPS provides high quality, low noise, pure and uninterrupted power supply.

Its modular and hot-swappable design provides a highly cost-effective solution to your power requirements. The number of Power Modules installed in the UPS can be customized based on your needs. As your power demands arise, you can easily increase system capacity by adding more Power Modules to the UPS. This design also makes module maintenance quick, easy, and non-interruptive to the operation of the system.

The Hot Standby Redundancy, Common Battery and ECO Modes can be used to enhance operation efficiency and reliability. Its communication interfaces and smart slots allow remote system monitoring and other extensive applications.

Moreover, you can install at maximum one rack-mount PDC (optional) in the UPS. The rack-mount PDC provides excellent branch protection and branch monitoring functions. You can also choose the optional hot-swappable battery module (at maximum four; each has four battery boxes) to provide stable back-up power. For more information, please refer to **5.7 Battery Module**.

2.2 Package Inspection

- **External**

During UPS transportation, some unpredictable situations might occur. It is recommended that you inspect its exterior packaging. If you notice any damage, please immediately contact the dealer from whom you purchased the unit.

- **Internal**

1. Check the rating label on the inside of the UPS and make sure the device No. and capacity match what you ordered.
2. Examine if any parts are loose or damaged.
3. The UPS package includes the following items:



No.	Item	Quantity
①	UPS	1 PC
②	User Manual	1 PC
③	RS232 Cable	1 PC (1.8m)
④	Parallel Cable	1 PC (5m)
⑤	Key	1 Set (two copies placed inside the UPS cabinet)
⑥	REPO Dry Contact Terminal Block	1 PC (2-Pin)
⑦	Input Dry Contact Terminal Block	1 PC (4-Pin)
⑧	Output Dry Contact Terminal Block	1 PC (12-Pin)

4. If there is any damage or anything missing, please immediately contact the dealer from whom you purchased the unit.
5. If the UPS needs to be returned, carefully repack the UPS and all of the accessories using the original packing material that came with the unit.

2.3 Functions & Features

- Hot-swappable Control Module, STS Module and Power Modules allow uninterrupted operation during maintenance. The system capacity can be customized (25~75kVA).
- The rack-mounted PDC (optional; at maximum one) has flexibility to arrange its UPS's output power feeding according to its connected critical loads.
- Input power factor > 0.99 and input iTHD < 3%. The UPS delivers high efficiency and diminishes the impact of electrical pollution.
- Output power factor = 1.
- Overall efficiency > 96% saves on operation cost.
- Wide AC input voltage range (140Vac~276Vac) reduces frequent transfer from normal mode to battery mode to save battery consumption and prolong battery life.
- Batteries power on the UPS to provide stable AC power when there is no AC line available.
- Automatic input frequency detection (50/ 60Hz).
- Optional ECO Mode: when input voltage and frequency are within the range of rating voltage $\pm 10\%$ and rating frequency $\pm 5\text{Hz}$, the UPS will transfer to bypass mode; otherwise, the UPS will transfer to normal mode to reach higher efficiency.
- Automatically detects whether bypass power is out of range (default: voltage $\pm 10\%$, frequency $\pm 5\text{Hz}$). If yes, the UPS will stop supplying power to the critical loads to protect your electronic equipment.
- Single/ dual input configuration.
- Built-in manual bypass breaker and manual bypass mode auto detection.
- Automatic restart:
 1. The UPS will restart in normal mode automatically right after the AC line resumes following a low battery shutdown.
 2. The UPS returns automatically to normal mode from bypass mode after an overload condition or a short circuit condition is cleared.
- Surge protection and EMI filter functions.
- Connects several external battery cabinets to extend backup time.
- Sets up battery test and battery replacement alarms.
- Smart battery charger design allows auto-charging or manual-charging to reduce charging time.

- Local and remote emergency power off functions.
- Attaches communication interfaces and two smart slots for external monitoring applications. Install optional SNMP card (IPv4 or IPv6), Relay I/O card, and MODBUS card for network communication, additional dry contacts, and MODBUS communication.
- Built-in RS232 port allows monitoring and management of the UPS via the UPSentry 2012 software (<https://datacenter-softwarecenter.deltaww.com.cn>).
- Built-in SRAM records at maximum 3,000 event logs.

2.4 Exterior

On the front of the UPS, you can see a control panel and a door lock. Inside the cabinet, there is one rack-mount PDC slot, a Control Module (including communication interfaces), an STS Module, five breakers, three Power Module slots and four Battery Module slots. At the back of the UPS (after opening the rear doors, you can see the UPS's wiring terminal block and a Battery Breaker (Q5). If you install the rack-mount PDC (optional; at maximum one) in the UPS, you can also see the rack-mount PDC's wiring terminal block. Please refer to the rack-mount PDC's user manual for relevant information about the rack-mount PDC's installation, wiring and operation. The side panels are lockable. The casters at the bottom of the UPS can be used to move over short distances. The levelers fix and stabilize the UPS on the ground.

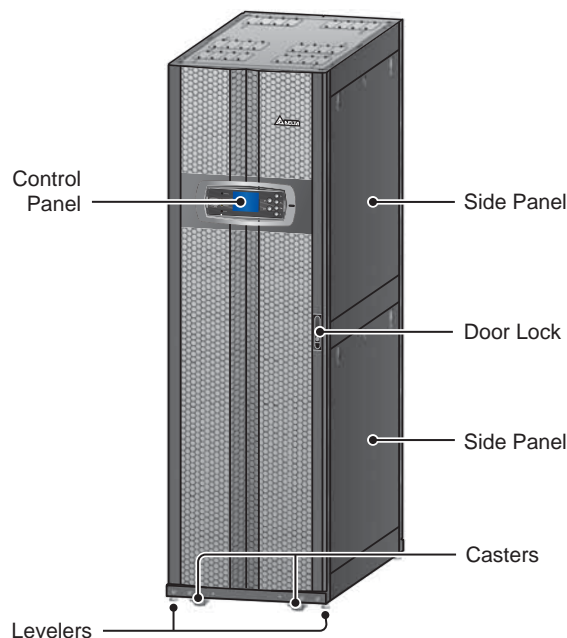

(Figure 2-1 : UPS Exterior)

2.4.1 Mechanism Data

DPH Dimensions			
UPS	Width	Depth	Height
25 ~ 75kVA	600mm	1090mm	2000mm



(Figure 2-2 : Dimensions)

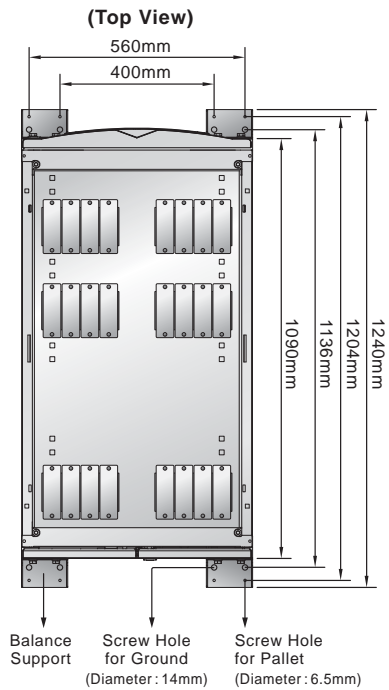

(Figure 2-3 : Mounting Hole Diagram)

2.4.2 Other Views

- **Front View** : Unlock and open the front door to see the rack-mount PDC slot, Control Module (including the communication interfaces), STS Module, Main Input Breaker (Q1), Bypass Breaker (Q2), Manual Bypass Breaker (Q3), Output Breaker (Q4), three Power Module slots and four Battery Module slots (see **Figure 2-4** and **Figure 2-5**).
- **Rear View** : Unlock and open the rear doors to see the rear of the UPS (see **Figure 2-6** and **Figure 2-7**).

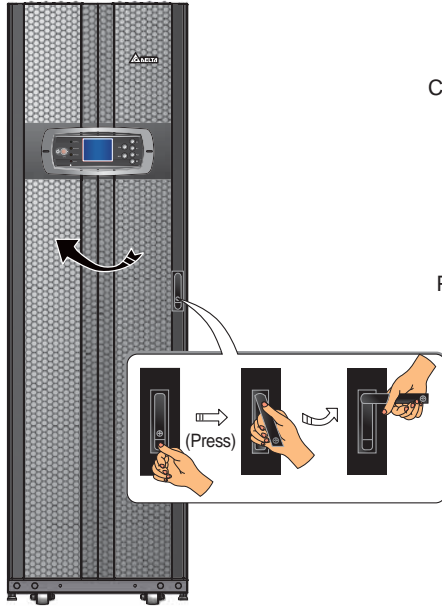

(Figure 2-4 : Front View)

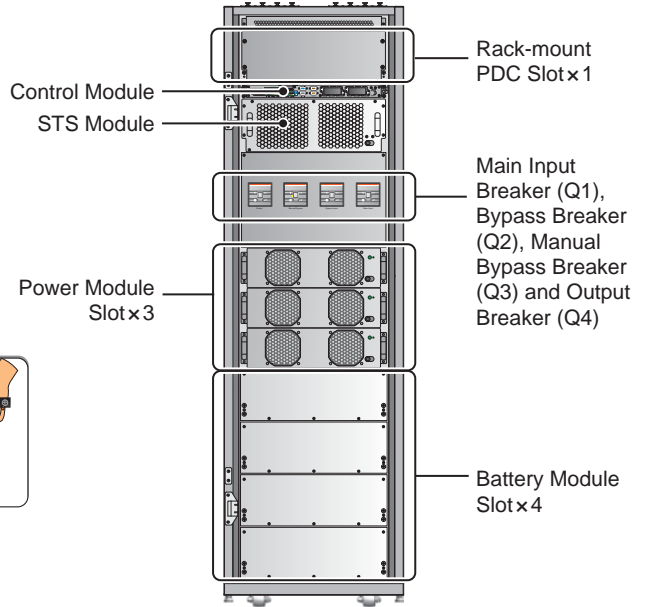

(Figure 2-5 : Front View with Front Door Open)

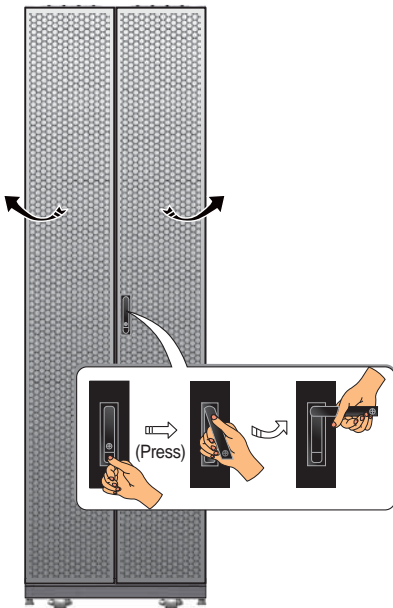

(Figure 2-6 : Rear View)

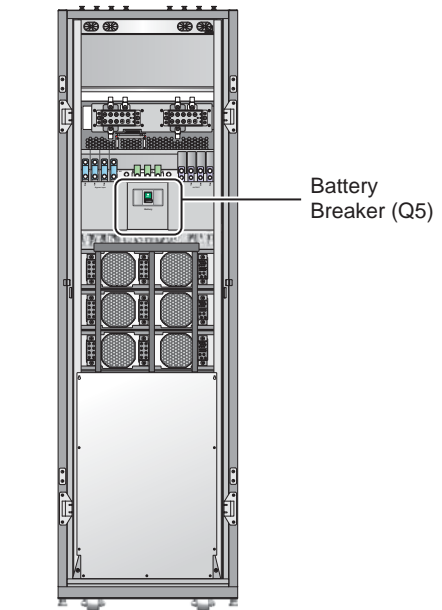

(Figure 2-7 : Rear View with Rear Door Open)

2.5 Control Panel

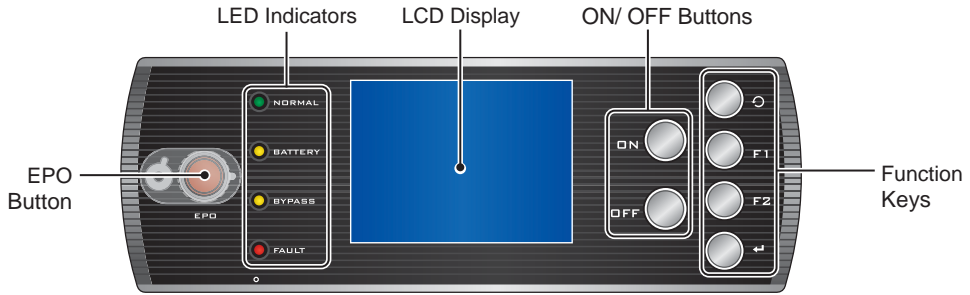

(Figure 2-8: Control Panel)

2.5.1 LED Indicators

No.	LED Indicator	Description
1	NORMAL	Lights up (green) in Normal Mode.
2	BATTERY	Lights up (yellow) in Battery Mode.
3	BYPASS	Lights up (yellow) in Bypass Mode.
4	FAULT	Lights up (red) when an abnormality is detected.





















2.5.2 ON, OFF, and EPO Buttons

Symbol	Button	Description
ON	ON Button	Press the ON button for 3~10 seconds and release it after you hear a beep. After the Power Modules initiate, the UPS starts up to supply power to the critical loads.
OFF	OFF Button	<p>Press the OFF button for 3 seconds, release it after you hear a beep and the system will show the message below. Please refer to 8. LCD Display and Settings to use the Control Panel.</p> <div style="text-align: center; border: 1px solid black; padding: 5px; width: fit-content; margin: 10px auto;"> SHUTDOWN UPS? YES NO </div> <p>Select "YES" to turn off the UPS (the inverter will be off). If you select "YES" and the system detects there is a risk of power interruption during transfer from inverter to bypass, the UPS will show the following message.</p> <div style="text-align: center; border: 1px solid black; padding: 5px; width: fit-content; margin: 10px auto;"> RISK OF LOAD DROP! SHUTDOWN UPS? YES NO </div> <p>To confirm turning off the UPS, select "YES" again.</p>
	EPO Button	When an emergency occurs, press this button to shut down the UPS rectifier, inverter and output.

2.5.3 LCD Display

The LCD supports multiple languages (default: English). To change the default language, please refer to **7.8.4 Change Display Language**.

2.5.4 Function Keys

No.	Symbol	Key	Function														
1		Return/ Cancel key	Goes back to previous screen or cancels current selection.														
2		Enter key	Enters a selected menu, item or confirms current selection.														
3	F 1 F 2	Function key F1 Function key F2	<p>Depend on the symbols shown on the LCD:</p> <table border="1"> <thead> <tr> <th>Symbol</th> <th>Function</th> </tr> </thead> <tbody> <tr> <td></td> <td>Moves up/ goes back to previous page.</td> </tr> <tr> <td></td> <td>Moves down/ goes to next page.</td> </tr> <tr> <td></td> <td>Moves left.</td> </tr> <tr> <td></td> <td>Moves right.</td> </tr> <tr> <td></td> <td>Increases number.</td> </tr> <tr> <td></td> <td>Decreases number.</td> </tr> </tbody> </table>	Symbol	Function		Moves up/ goes back to previous page.		Moves down/ goes to next page.		Moves left.		Moves right.		Increases number.		Decreases number.
Symbol	Function																
	Moves up/ goes back to previous page.																
	Moves down/ goes to next page.																
	Moves left.																
	Moves right.																
	Increases number.																
	Decreases number.																

2.6 Internal Mechanisms

2.6.1 Breakers

The UPS has five breakers. Open the UPS's front door and you will see the Main Input Breaker (Q1), Bypass Breaker (Q2), Manual Bypass Breaker (Q3) and Output Breaker (Q4). Open the UPS's rear doors and you will see the Battery Breaker (Q5). Please refer to **Figure 2-9**.

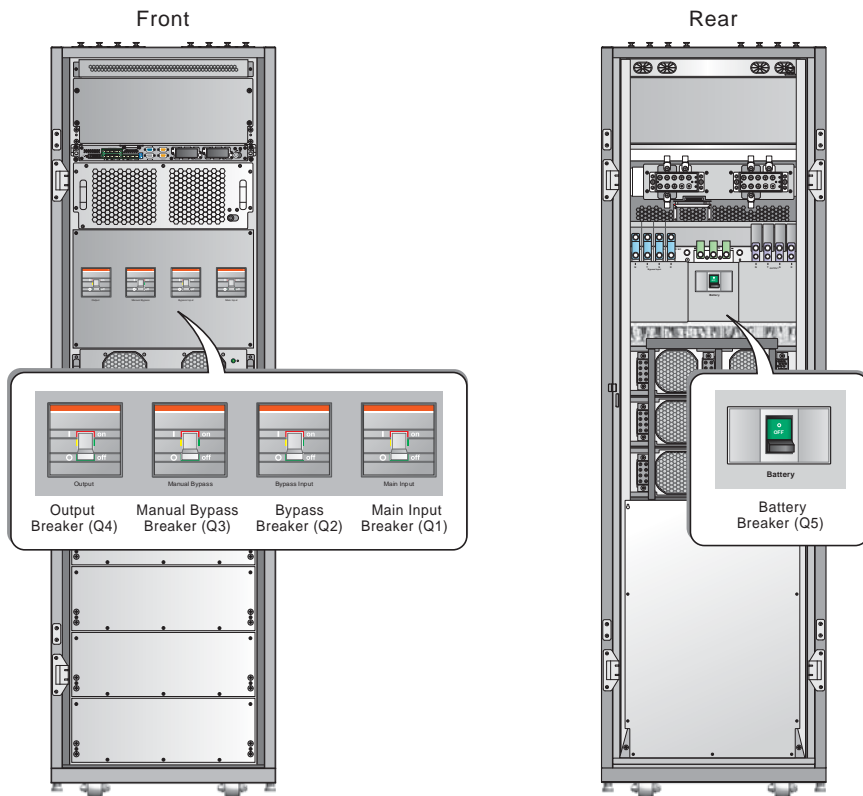

(Figure 2-9: Breaker Location)

2.6.2 Wiring Terminal Block

Open the UPS's back doors and you will see the wiring terminal block. For wiring instructions, please see **5. Installation and Wiring**.

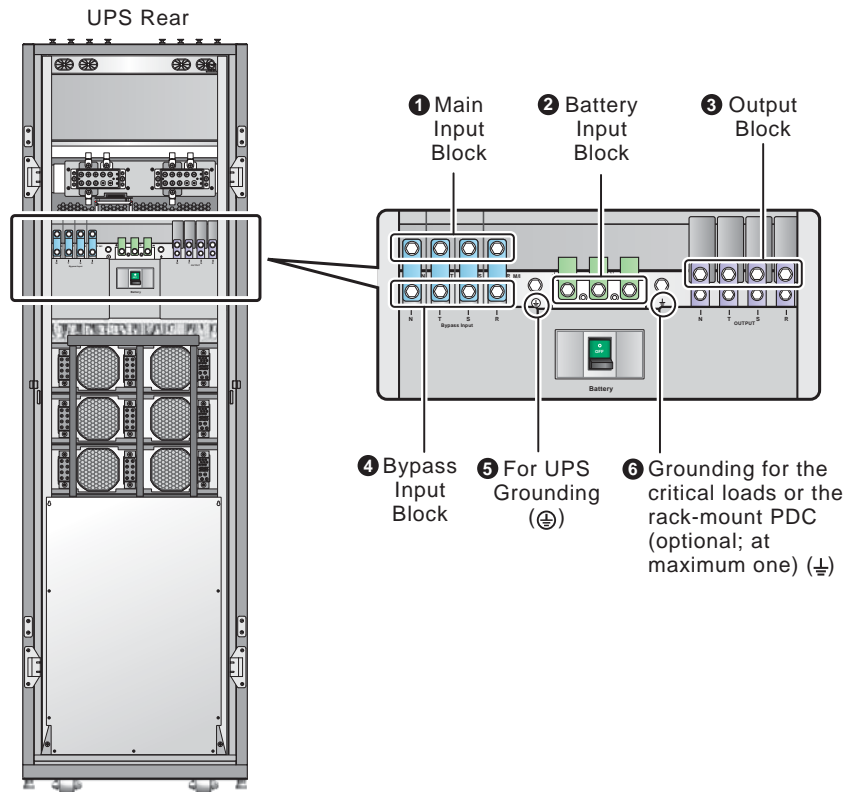

(Figure 2-10 : Rear View/ Wiring Terminal Block)

No.	Item	Function	Description
①	Main Input Block	Connects main AC source	Includes R, S, T and Neutral (N) terminals.
②	Battery Input Block	Connects an external battery cabinet	Includes Positive (+), Negative (-) and Neutral (N) terminals.
③	Output Block	Connects the critical loads or the rack-mount PDC (optional; at maximum one)	Includes R, S, T and Neutral (N) terminals.
④	Bypass Input Block	Connects bypass AC source	Includes R, S, T and Neutral (N) terminals.
⑤	⊕	For UPS grounding (safety)	Includes one grounding terminal.
⑥	⊕	Grounding for the critical loads or the rack-mount PDC (optional; at maximum one).	Includes one grounding terminal.

**NOTE:**

1. Panel removal or wiring can only be performed or supervised by qualified service personnel.
2. Phase symbols may be different for each country. Please refer to the table below.

USA/ Asia	Europe	India
R	U	R
S	V	Y
T	W	B

2.6.3 Modules

- **Rack-mount PDC (optional; at maximum one):** Includes one hot-swappable Control Module and six hot-swappable Breaker Module slots. Please refer to the rack-mount PDC's user manual for more information.
- **Control Module:** Includes the communication interfaces. Please refer to **4. Communication Interfaces**.
- **STS Module:** Includes three internal Static Transfer Switches and three fuses.
- **Power Module (optional; at maximum three):** The Power Module's capacity is 25kVA/ 25kW. The Power Module has a power factor correction rectifier, a battery charger, an inverter and control circuits.
- **Battery Module (optional, at maximum four):** A battery module includes four battery boxes. Please note that the UPS can use either the external battery cabinet (at maximum four) or the battery module (optional; at maximum four). The UPS cannot use them at the same time. Please only choose one application. For more information, please refer to **5.6 External Battery Cabinet & 5.7 Battery Module**.

Each hot-swappable Control Module (optional), hot-swappable Breaker Module (optional), Control Module, STS Module, and Power Module (optional) has a module latch that locks the module in the cabinet and is hot-swappable for convenient maintenance and replacement. For installation and function information, please refer to **5.9 Other Modules**. The hot-swappable Control Module (optional), STS Module and Power Module (optional) have LED indicators to indicate operation status. Please note that the rack-mount PDC (optional, at maximum one) is not hot-swappable.

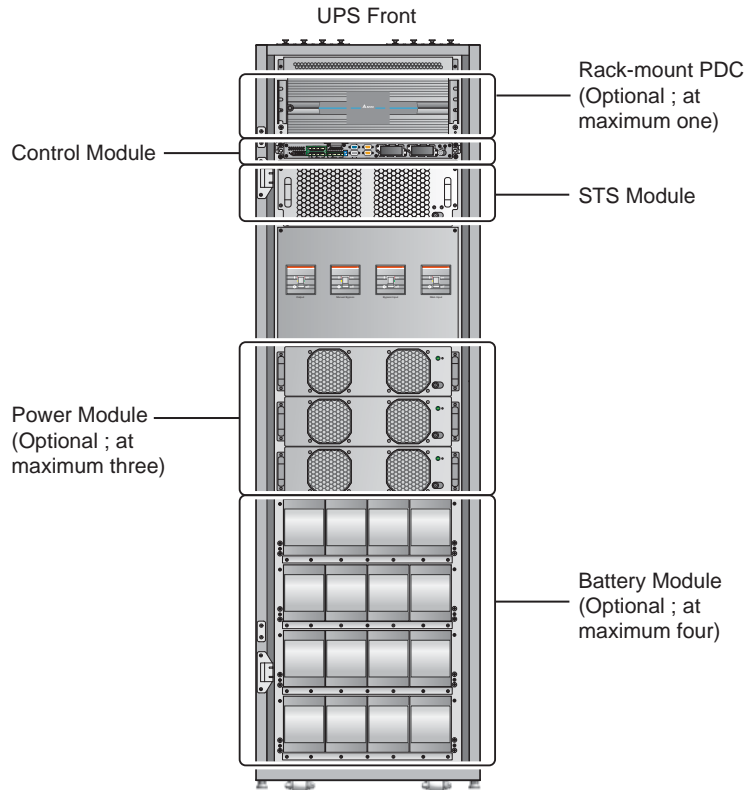

(Figure 2-11 : Front View/ Modules)

2.6.4 Battery Fuses

Open the UPS's rear doors, remove the 9 screws from the lower panel shown in **Figure 2-12** and you will see the 16 battery fuses (see **Figure 2-13**) that have been installed in the UPS before the USP is shipped out of the factory. Each battery fuse's specification is DC 600V 30A and is exclusively for the battery module's use. The battery module is optional (at maximum four), each battery module includes four battery boxes, and each battery module is protected by the relevant battery fuses. If you need to replace the battery fuses, please contact service personnel. Do not perform replacement and maintenance yourself.

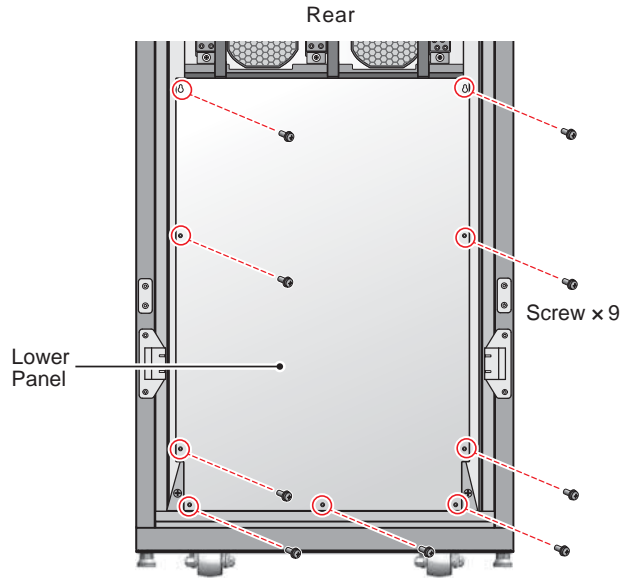

(Figure 2-12: Open the UPS's Rear Doors and Remove the Lower Panel)

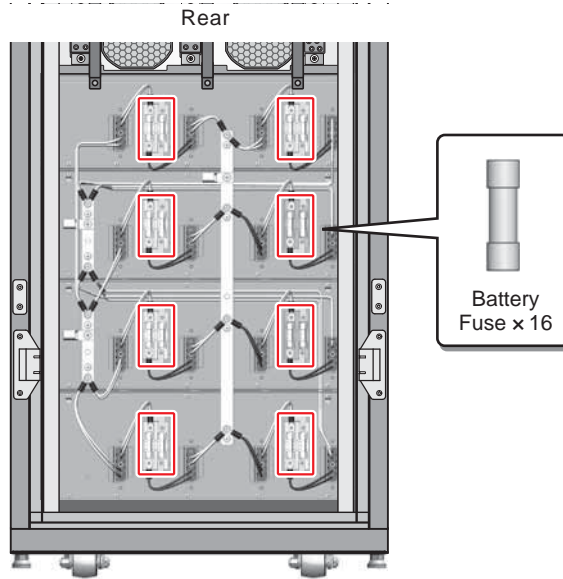

(Figure 2-13: Battery Fuse Location)

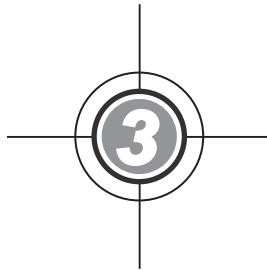

Operation Modes

- 3.1 Normal Mode (Single)
- 3.2 Battery Mode (Single)
- 3.3 Bypass Mode (Single)
- 3.4 Manual Bypass Mode (Single)
- 3.5 ECO Mode (For Single Unit Only)
- 3.6 Normal Mode (Parallel)
- 3.7 Battery Mode (Parallel)
- 3.8 Bypass Mode (Parallel)
- 3.9 Manual Bypass Mode (Parallel)
- 3.10 Hot Standby Redundancy
- 3.11 Common Battery

The UPS system supplies power to the connected critical loads with four basic operation modes, which are normal mode, battery mode, bypass mode and manual bypass mode. The unit automatically switches between these modes as required to make sure that the critical loads are protected from power interruption. Besides these four operation modes, the UPS is also designed for hot standby redundancy, common battery, and ECO mode functions. Please see the following sections for single unit and parallel units' operation modes, hot standby redundancy, common battery and ECO mode configurations.



NOTE:

1. The UPS's output can connect to either the critical loads or the rack-mount PDC (optional; at maximum one). Please only choose one application. If the UPS's output connects to the rack-mount PDC (optional; at maximum one), please refer to the rack-mount PDC's user manual for relevant information about the rack-mount PDC's installation, wiring and operation.
2. The Q1, Q2, Q3, Q4 and Q5 breakers shown in the following diagrams represent Main Input Breaker, Bypass Breaker, Manual Bypass Breaker, Output Breaker and Battery Module Breaker respectively.
3. Only UPSs with the same system capacity, voltage and frequency can be paralleled; otherwise, parallel functions will fail.
4. Each paralleled UPS's power module quantity shall be equivalent or near upon equivalent.

3.1 Normal Mode (Single)

In Normal Mode, the main AC power supplies the rectifier via the Main Input Breaker (Q1). The rectifier converts the AC to DC power, supplies DC power to the inverter, and charges the batteries. The inverter converts and filters the DC power into pure and stable AC power, and supplies the AC power via the static switch and the Output Breaker (Q4) to the connected critical loads. Please see **Figure 3-1**.

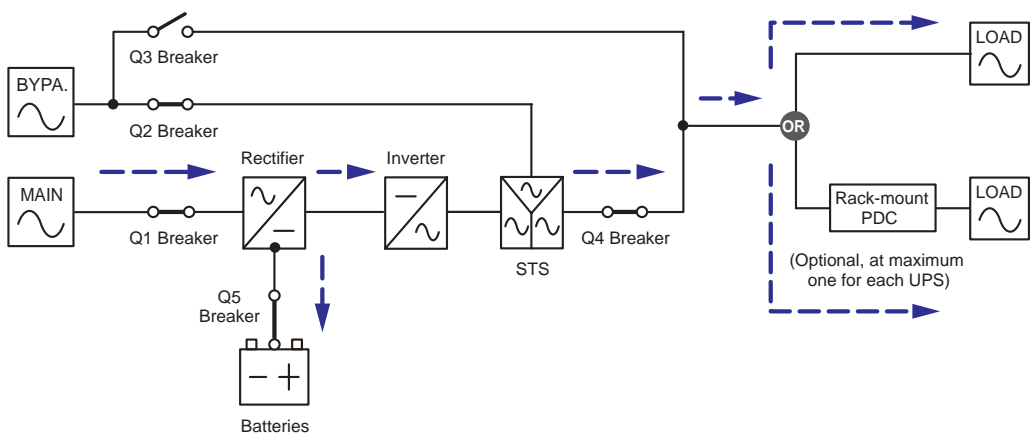

(Figure 3-1 : Normal Mode Diagram, Single)

3.2 Battery Mode (Single)

The UPS automatically transfers to Battery Mode if the main AC power fails, for example, when unstable voltage or a power outage occurs.

In battery mode, the batteries provide DC power and the inverter converts it into AC power and supplies it to the connected critical loads via the static switch and the Output Breaker (Q4). During the transfer process, output voltage remains the same. Please see **Figure 3-2**.

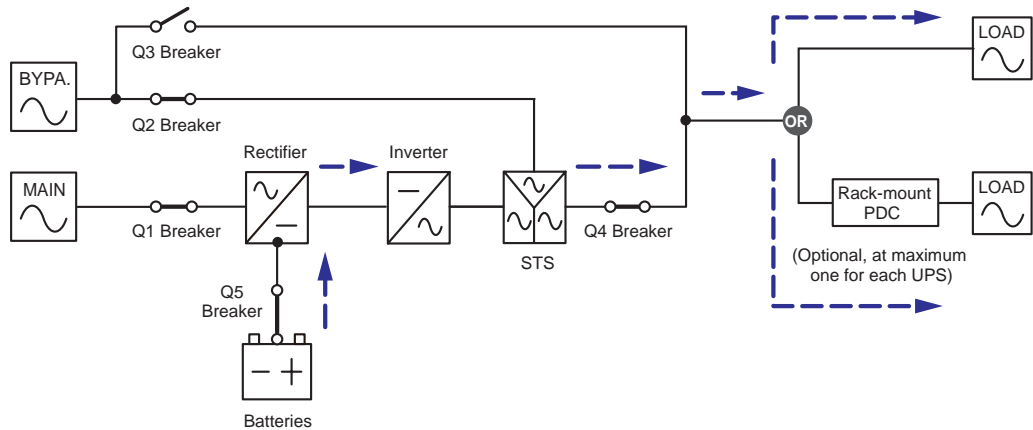

(Figure 3-2 : Battery Mode Diagram, Single)

3.3 Bypass Mode (Single)

When the inverter encounters abnormal situations such as over temperature, overload, short circuit, abnormal output voltage or low battery, it shuts itself down to protect the UPS. If the bypass power is normal, the UPS will transfer to Bypass Mode to supply power to the critical loads. After the abovementioned abnormalities are cleared, the UPS will transfer back to Normal Mode. See **Figure 3-3**.

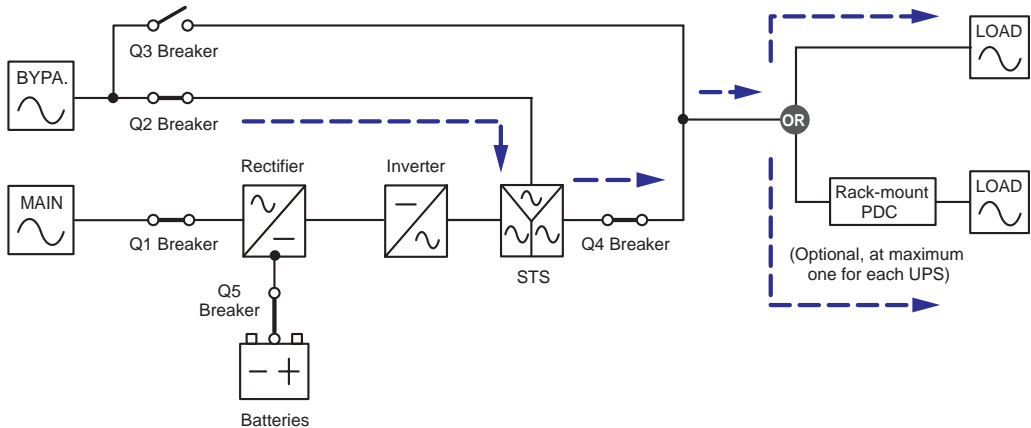

(Figure 3-3 : Bypass Mode Diagram, Single)

3.4 Manual Bypass Mode (Single)

When the UPS needs maintenance, you can manually switch the UPS to manual bypass mode after you have confirmed the bypass AC source is normal. In manual bypass mode, all power inside the UPS is completely cut off and maintenance personnel can perform maintenance safely. Please see **Figure 3-4**.

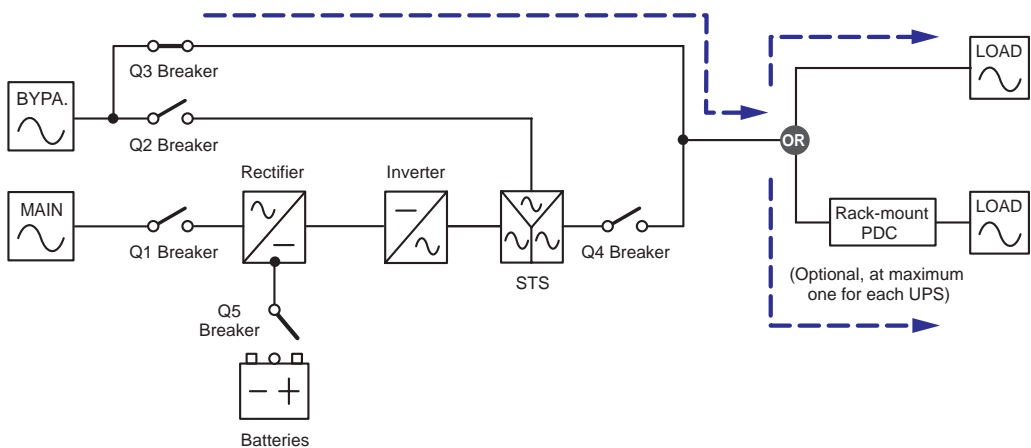

(Figure 3-4 : Manual Bypass Mode Diagram, Single)



WARNING!

1. In Manual Bypass Mode, make sure all external battery cabinets' breakers and the Battery Breaker (Q5) are switched to the **OFF** position before working on the UPS's internal circuits. This avoids electrical shock.
2. During maintenance, if the UPS's input power is cut off, the connected critical loads won't be protected.

**NOTE:**

After the power inside the UPS has been completely cut off, there is no high voltage inside the UPS except the wiring terminal block, the Manual Bypass Breaker (Q3), the Battery Breaker (Q5) and the rack-mount PDC (optional; at maximum one). Do not touch the wiring terminal block, the Manual Bypass Breaker (Q3), the Battery Breaker (Q5) and the rack-mount PDC (optional; at maximum one) to avoid electrical shock.

3.5 ECO Mode (For Single Unit Only)

You can only use ECO mode for a single unit but not for parallel units. In ECO Mode, when the bypass input voltage is within $\pm 10\%$ of the rating voltage and the input frequency is within ± 5 Hz of the rating frequency, the UPS transfers to Bypass Mode; otherwise, the UPS runs in Normal Mode. To activate ECO Mode, please see **7.7.2 Output Setup** for more information.

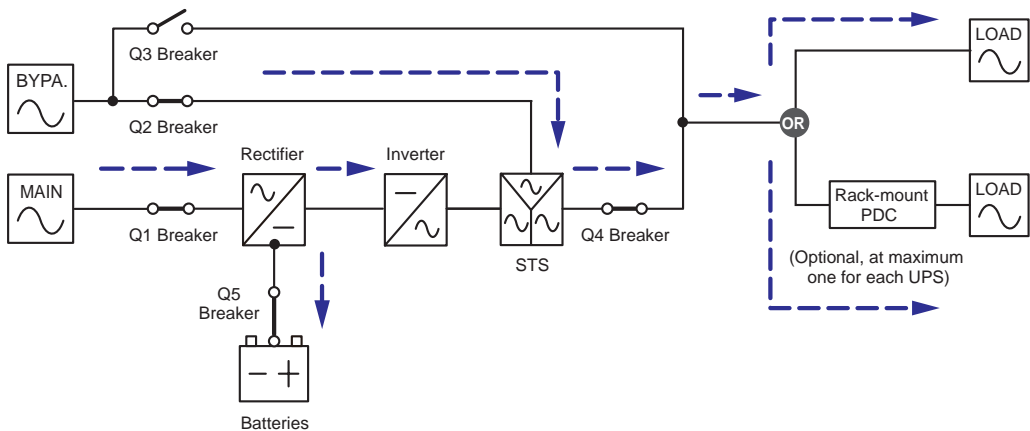

(Figure 3-5 : ECO Mode Diagram, Single)

3.6 Normal Mode (Parallel)

Up to four UPSs can be paralleled for redundancy and capacity expansion.

In Normal Mode (parallel), the critical loads will be equally shared by the paralleled units.

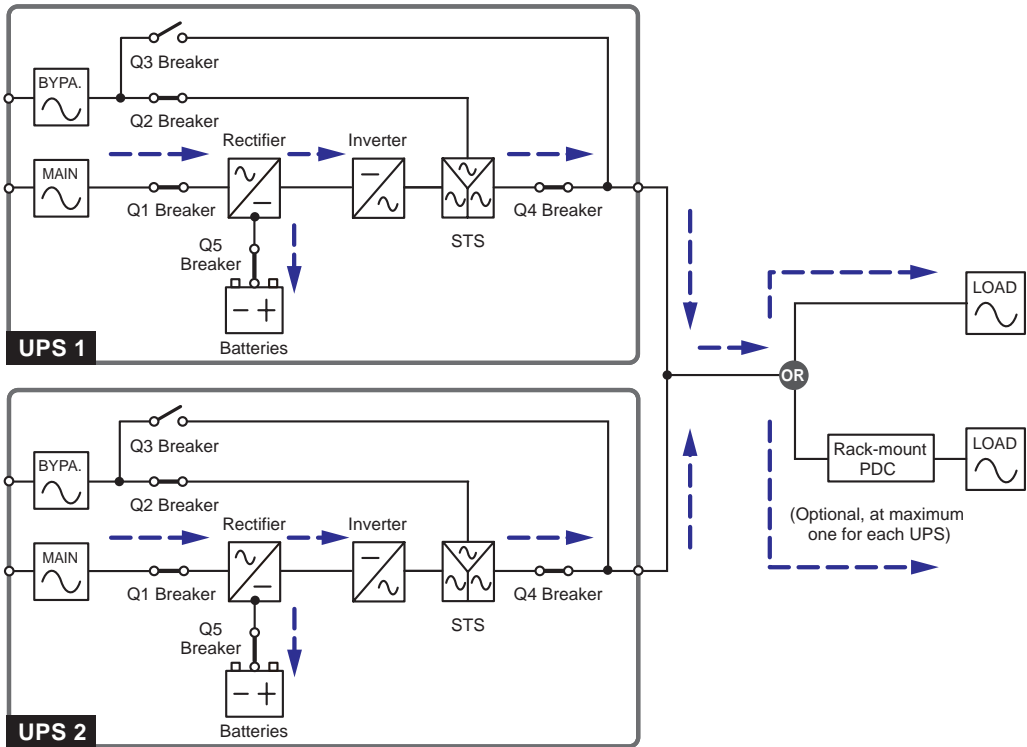

(Figure 3-6 : Normal Mode Diagram, Parallel)

If a UPS fails and its load is less than the total capacity of the remaining parallel UPSs, its output will be cut off and its load will be equally shared by the other UPSs. If the failing UPS's load is larger than the total capacity of the remaining parallel UPSs, all UPSs' inverters will turn off and the total load will be supplied by bypass power.

3.7 Battery Mode (Parallel)

If the main AC power cannot supply power, for example, when voltage is unstable or a power outage occurs, all parallel UPSs will automatically transfer from Normal Mode to Battery Mode. During the transfer process, output voltage remains the same. Please see *Figure 3-7*.

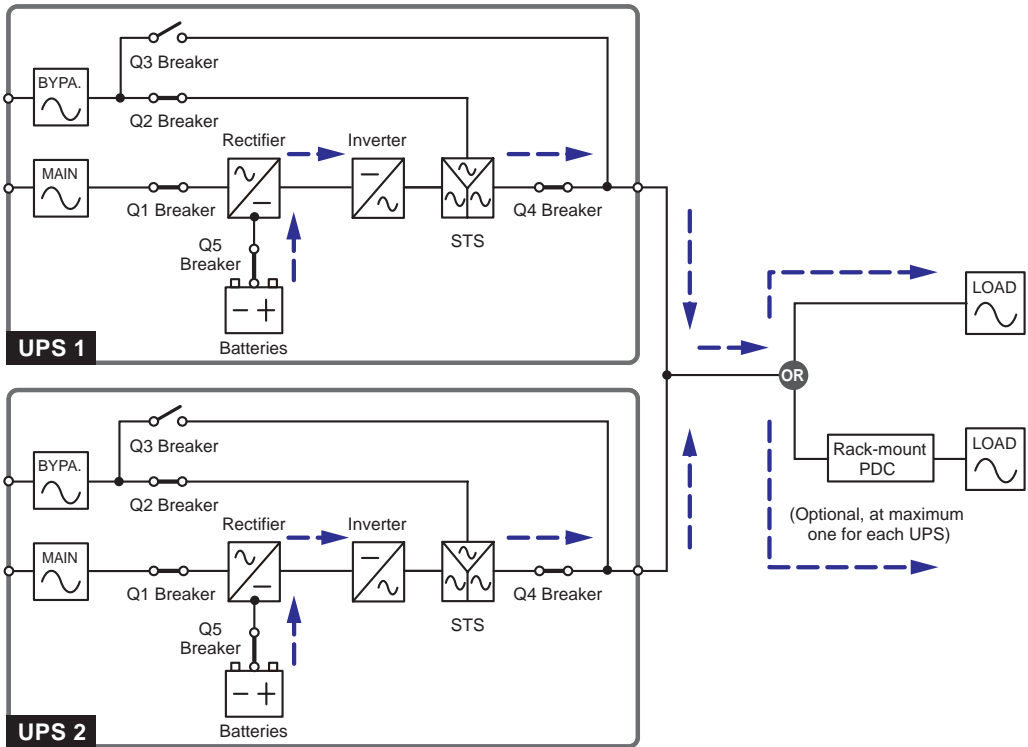

(Figure 3-7 : Battery Mode Diagram, Parallel)

3.8 Bypass Mode (Parallel)

In parallel mode, when all inverters encounter abnormal situations such as over temperature, overload, short circuit, abnormal output voltage and battery depletion, they will automatically shut themselves down to protect the UPSs' systems. Meanwhile, if all UPSs detect the bypass AC source is normal, they will automatically switch to bypass mode to protect the connected critical loads from power interruption. The critical loads will be equally shared by all parallel units. After the abnormalities mentioned above are eliminated, the UPSs will switch back to normal mode from bypass mode. Please see **Figure 3-8**.

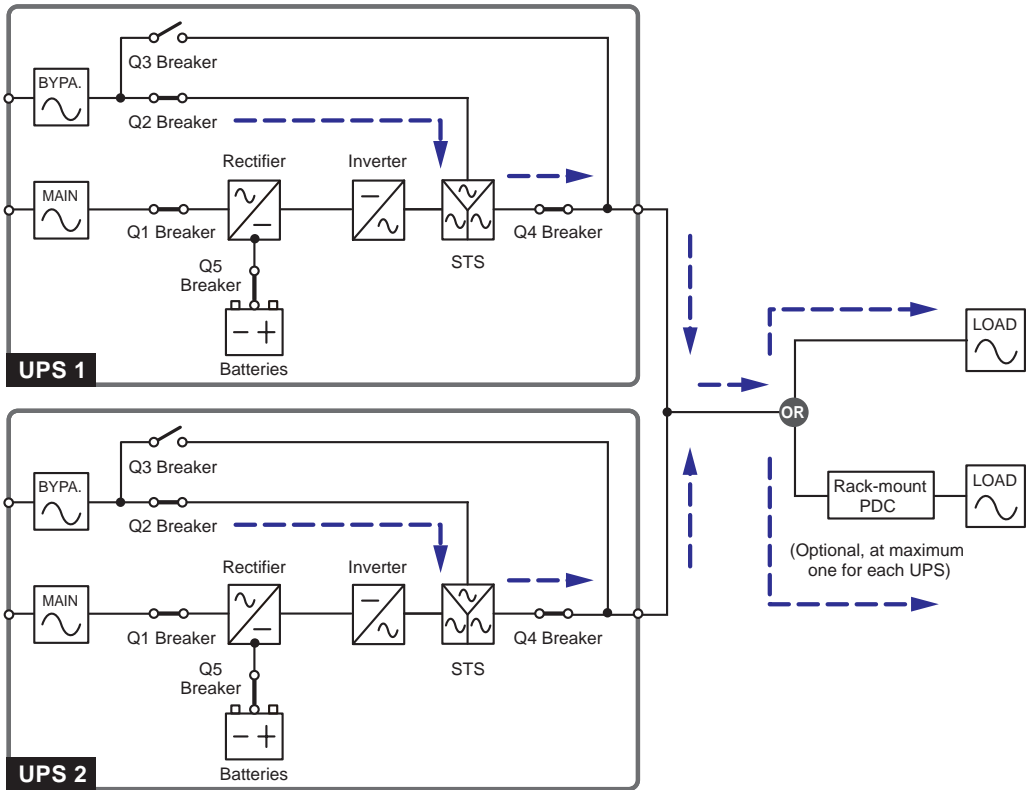

(Figure 3-8 : Bypass Mode Diagram, Parallel)

3.9 Manual Bypass Mode (Parallel)

In parallel mode, if you want a UPS to run in manual bypass mode, please confirm that the bypass AC source is normal. After confirmation, you can manually switch all UPSs to manual bypass mode. In manual bypass mode, all power inside the UPSs is completely cut off and maintenance personnel can perform maintenance safely. The connected critical loads will be equally supplied by the parallel units. Please see **Figure 3-9**.

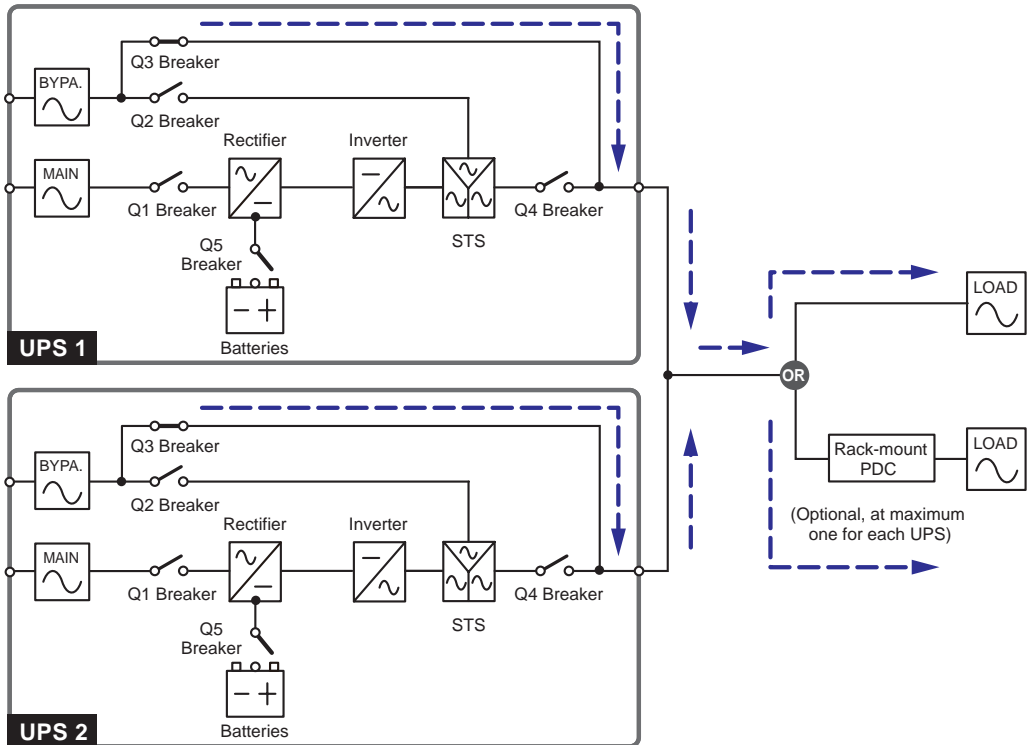

(Figure 3-9 : Manual Bypass Mode Diagram, Parallel)



WARNING!

1. In Manual Bypass Mode, make sure each UPS's external battery cabinets' breakers and each UPS's Battery Breaker (Q5) are switched to the **OFF** position before working on any UPS's internal circuits. This avoids electrical shock.
2. During maintenance, if the parallel UPSs' input power is cut off, the connected critical loads won't be protected.



NOTE:

1. After the power inside all parallel UPSs has been completely cut off, there is no high voltage inside the UPSs except each UPS's wiring terminal block, Manual Bypass Breaker (Q3), Battery Breaker (Q5) and rack-mount PDC (optional; at maximum one). Do not touch each UPS's wiring terminal block, Manual Bypass Breaker (Q3), Battery Breaker (Q5) and rack-mount PDC (optional; at maximum one) to avoid electrical shock.
2. For parallel UPSs, if you want to turn off one of the parallel UPSs for maintenance, please make sure the connected critical loads will not exceed the remaining parallel units' total capacity.

3.10 Hot Standby Redundancy

To provide customers more application choices, the UPS with a dual-input configuration can have a hot standby redundancy function. If you use two UPSs and wish them to work in the hot standby redundancy mode, please connect the output of UPS1 to the bypass power of UPS 2. Please see **Figure 3-10**.

For more information about the hot standby redundancy application, please contact service personnel.

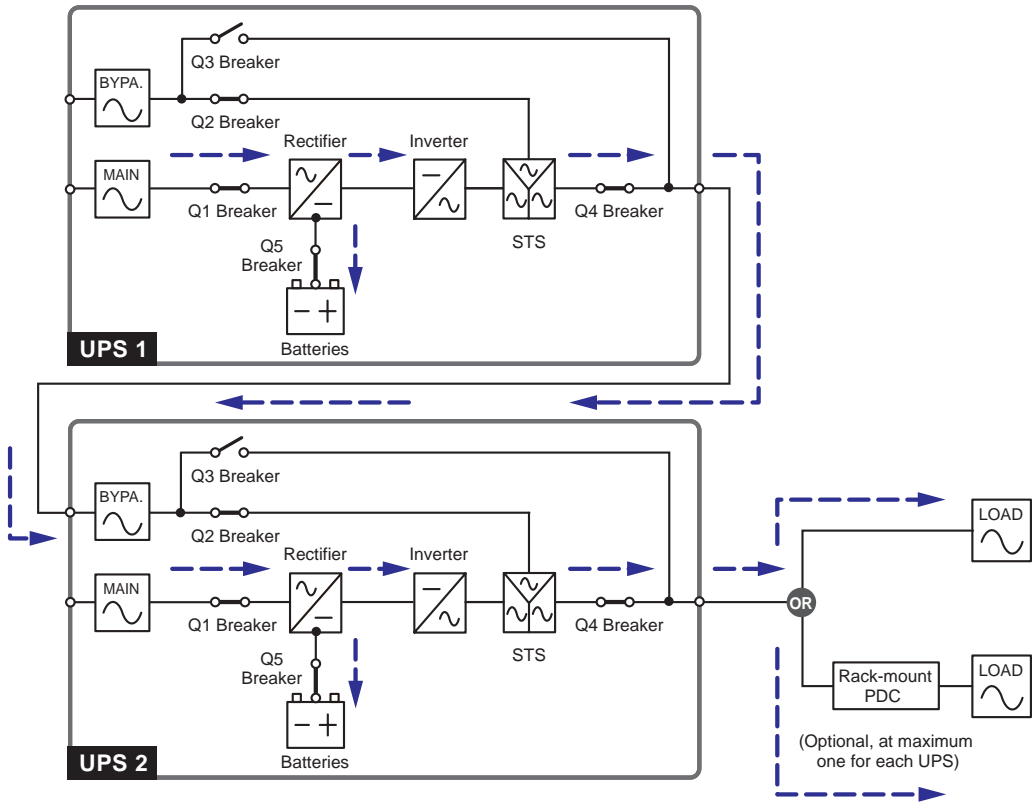

(Figure 3-10 : Hot Standby Redundancy Diagram)

In normal condition, it is the UPS 2 inverter that supplies power to the critical loads. When the UPS 2 inverter becomes abnormal, the UPS 2 will automatically transfer to bypass mode and the UPS 1 inverter will supply power to the critical loads.

3.11 Common Battery



WARNING!

1. For battery usage, the UPS can use either the external battery cabinet (at maximum four) or the battery module (optional; at maximum four). The UPS cannot use them at the same time. Please only choose one application. For more information, please refer to **5.6 External Battery Cabinet** & **5.7 Battery Module**.
2. When $50\text{kVA} < \text{total load} \leq 75\text{kVA}$, the UPS must use the external battery cabinet (at maximum four) but not the battery module.
 When $25\text{kVA} < \text{total load} \leq 50\text{kVA}$, the UPS can use either the external battery cabinet (at maximum four) or at least four battery modules (a battery module includes four battery boxes).
 When the total load is $\leq 25\text{kVA}$, the UPS can use either the external battery cabinet (at maximum four) or at least two battery modules (a battery module includes four battery boxes).
 When the UPS uses four battery modules (optional) and the total load is 50kVA, the batteries can supply power for at least 5 minutes.
3. Common battery is only applicable for the external battery cabinet (at maximum four) but not for the battery module.

To save on your costs and installation space, parallel UPSs can share external battery cabinets. To do so, install an isolated switch between each UPS and its connected external battery cabinets. **Figure 3-11** shows a configuration of two parallel UPSs sharing a external battery cabinet.

To share battery cabinets, you must use the control panel to configure battery-related settings. Please see **7.7.3 Battery Setup** and **7.7.4 Charger Setup**.

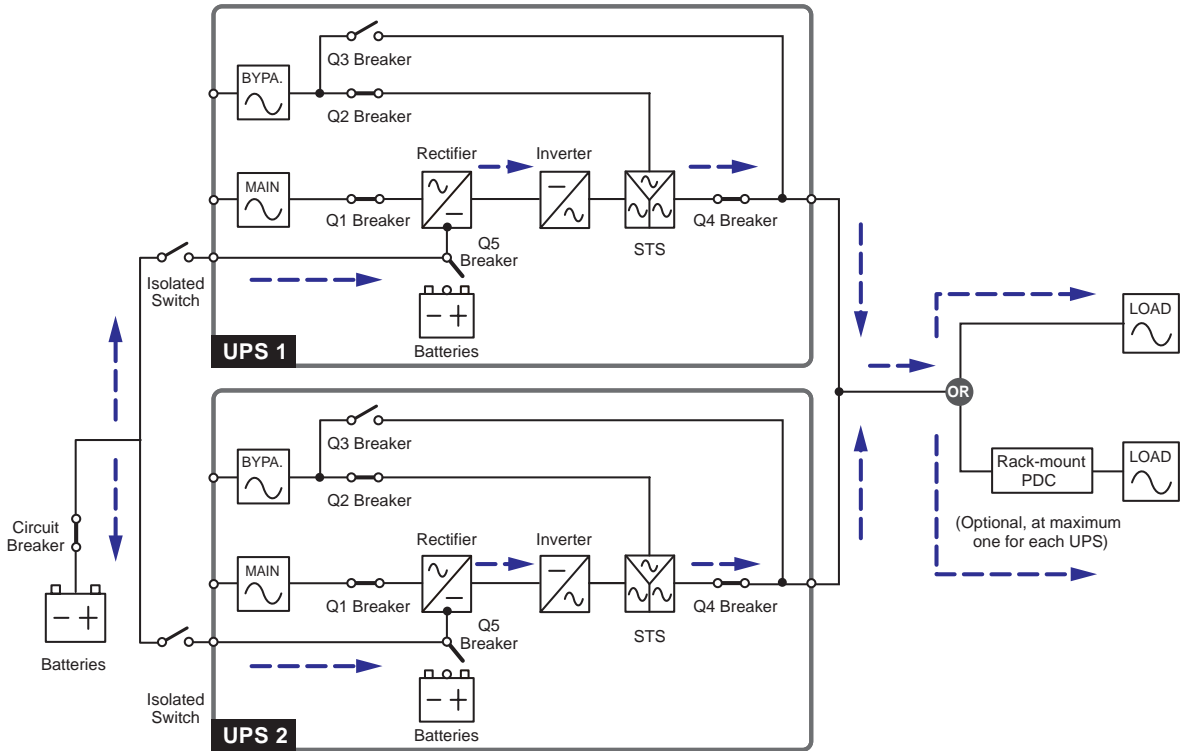

(Figure 3-11 : Common Battery Diagram)



NOTE:

Please note that you should set each UPS float voltage (default: 272v) the same, each UPS boost voltage (default: 288v) the same, and set each UPS charge current even. For example, when two UPSs are paralleled, they share one battery cabinet, battery type is 200AH, and you want to set the battery cabinet's charge current as 20A. You should set each UPS's **TYPE(AH)** as 200AH, **BAT STRINGS** as 1, and **CHARGE CURRENT (A)** as 10A.

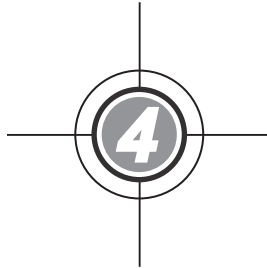

Communication Interfaces

- 4.1 LCD Port
- 4.2 Output Dry Contacts
- 4.3 Input Dry Contacts
- 4.4 Battery Dry Contacts
- 4.5 System Communication Port
- 4.6 DIP Switches
- 4.7 LCM Port
- 4.8 Parallel Ports
- 4.9 Smart Slots

The communication interfaces include a LCD port, output dry contacts, input dry contacts, battery dry contacts, DIP switches, a system communication port, a LCM port, parallel ports and two smart card slots. Please see the figure below.

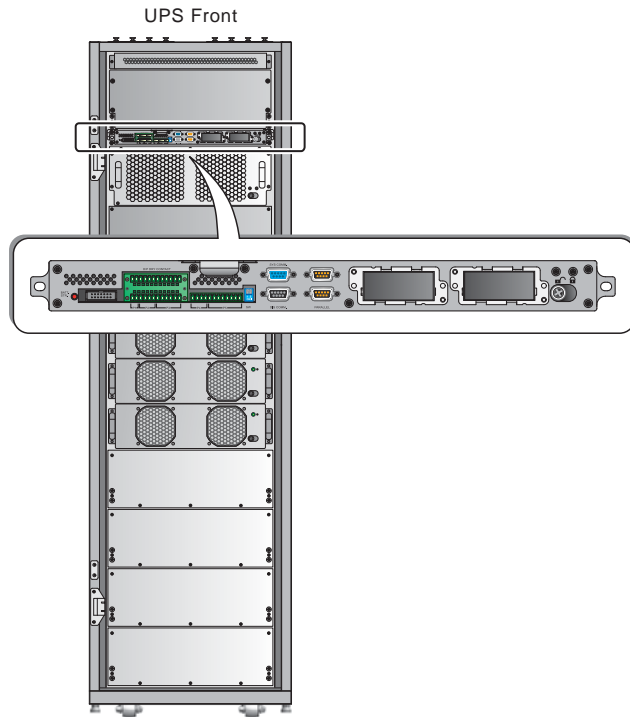

(Figure 4-1 : Front View/ Communication Interfaces)

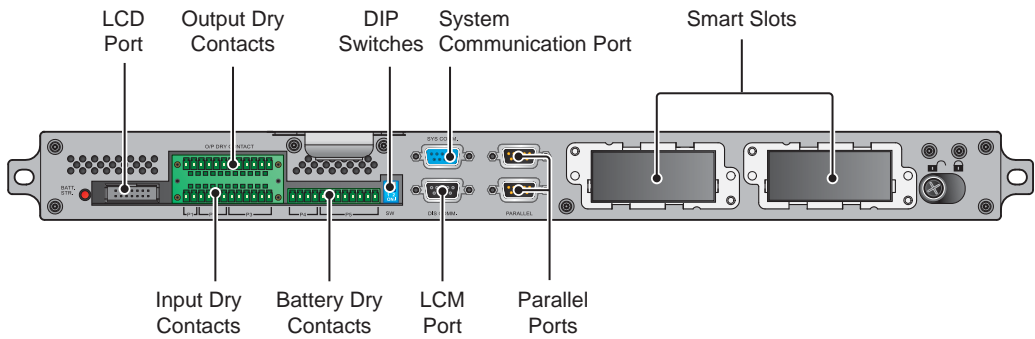

(Figure 4-2 : Communication Interfaces)

4.1 LCD Port

This port connects to the LCD display with the provided cable.

4.2 Output Dry Contacts

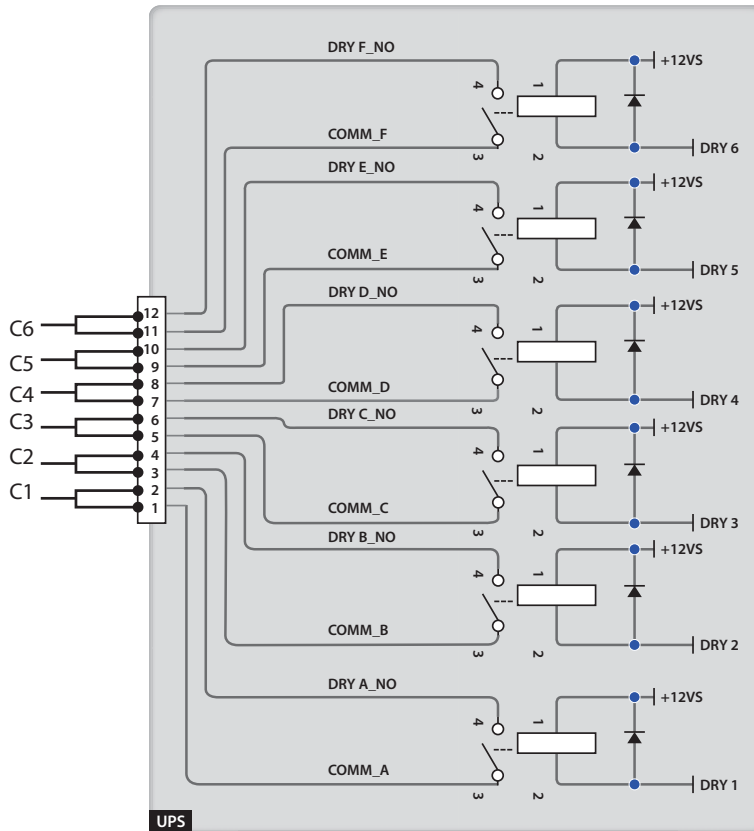

(Figure 4-3: Output Dry Contacts Design)

There are six sets of programmable output dry contacts. Each set can be assigned with a specific event. Six out of nineteen events can be assigned according to your applications. For each dry contact, you can define its status as NO (Normally Open) or NC (Normally Close). There is no default setting. To learn how to set up, please contact your local dealer. For the nineteen events, please refer to the table below.

No.	Event	Description
1	Load on inverter	The UPS works in Normal Mode.
2	Load on bypass	The UPS works in Bypass Mode.
3	Battery discharge/ Main input NOK	The main AC source fails and the batteries supply power to the critical loads.
4	Low battery	The UPS runs in Battery Mode and the battery voltage is lower than the configured threshold.

No.	Event	Description
5	Bypass input NOK	The bypass voltage, frequency or phase sequence is abnormal.
6	Battery test fail or battery missing	During the battery test, the battery voltage is out of the configured range.
7	Internal communication failure	A Power Module's internal communication is abnormal.
8	External parallel communication loss	In Parallel Mode, parallel communication is abnormal.
9	Output overload warning/ shutdown	The UPS is overloaded or the UPS shuts down to let the bypass supply power to the critical loads.
10	Power module fault shutdown	A Power Module has abnormalities and it shuts down the UPS to let the bypass supply power to the critical loads.
11	Power module warning	A Power Module is abnormal but the UPS still runs in Normal Mode.
12	EPO activated	The EPO button is pressed and the UPS is shut down.
13	Load on manual bypass	The Manual Bypass Breaker (Q3) is turned on and the UPS transfers to Manual Bypass Mode.
14	Battery cabinet over temperature warning/ shutdown	The battery temperature is too high.
15	Abnormal inverter voltage	The output voltage is too high or too low.
16	Battery needs replacement	Battery replacement date is due.
17	Bypass over temperature warning/ shutdown	Bypass static switch temperature is too high.
18	Bypass static switch fault	The bypass static switch has open/ short issue.
19	General alarm	When any UPS alarm occurs.

4.3 Input Dry Contacts

The input dry contacts allow the UPS to receive signals from peripheral devices. Please refer to the following:

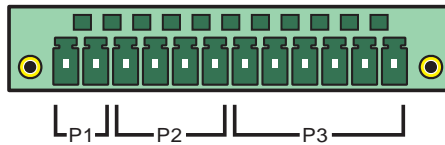

(Figure 4-4: Input Dry Contacts)

- **P1: REPO**

This dry contact provides you with a quick and convenient interface to safely shut down the UPS when an emergency occurs. Connect this dry contact to a user-supplied switch and you can remotely shut down the UPS. The REPO dry contact is normally open in normal circumstances.

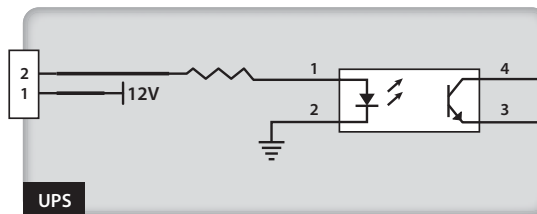

(Figure 4-5: REPO Dry Contacts)

- **P2: Input Dry Contacts (Two Sets)**

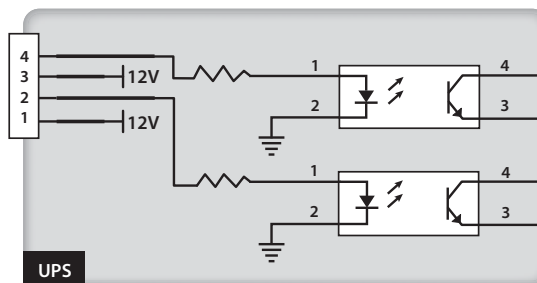

(Figure 4-6: Input Dry Contacts (Two Sets))

The two sets of dry contacts can receive external signals and let the UPS response accordingly. The dry contacts are Normally Open and two events can be assigned. Please see below:

No.	Event	Description
1	Battery ground fault	Battery ground abnormalities (P2: default setting for Pin 1-2).
2	Generator power supply	The main input is supplied by a generator (P2: default setting for Pin 3-4).

- **P3: External Manual Bypass Breaker Dry Contacts (Three Sets)**

The three sets of dry contacts can be used to detect the status of three external Manual Bypass Breakers. Connect the dry contacts to Normally Open ports.

4.4 Battery Dry Contacts

You can use these dry contacts to detect external battery cabinets' temperature and status. Please see the figure below:



(Figure 4-7: Battery Dry Contacts)

- **P4: Battery Cabinet Status Detection**

You can use an appropriate cable to connect the UPS's P4 dry contacts and one external battery cabinet to obtain the external battery cabinet's status. Please contact service personnel for cable information.

- **P5: Battery Cabinet Temperature Detection**

You can purchase a battery cabinet temperature sensor cable (optional) to connect the UPS's P5 dry contacts and one external battery cabinet to detect the battery cabinet's temperature. You can use at maximum four temperature sensor cables to connect the UPS and four external battery cabinets.



NOTE:

To purchase optional accessories, contact your service personnel. To learn more about all available accessories, please refer to **8. Optional Accessories**.

4.5 System Communication Port

Use the provided RS-232 cable to connect a computer to the system communication port, and download the UPSentry 2012 software (<https://datacenter-softwarecenter.deltawww.com.cn>) to record the UPS power events, set up alarms, shut down the UPS safely and monitor multiple UPSs to facilitate centralized control.

4.6 DIP Switches

The DIP Switches are used for parallel configurations. Please refer to **6.3 Parallel Unit Operation Procedures**.

4.7 LCM Port

This port is reserved for service personnel to diagnose and maintain the UPS. Do not connect this port without any given instruction.

4.8 Parallel Ports

The parallel ports are used to connect parallel UPSs. With the provided parallel cables, up to four UPSs of the same system capacity, voltage and frequency can be paralleled. Each paralleled UPS's power module quantity shall be equivalent or near upon equivalent.



WARNING!

Only use the provided cables to parallel UPSs. Connect the parallel ports using other cables might cause malfunctions.

4.9 Smart Slots

Insert optional cards into the smart slots for additional functions. The system communication port remains functional when optional cards are installed. Please refer to the table below for optional cards:

Optional Card	Function
SNMP Card (IPv4 or IPv6)	Monitors the UPS via SNMP protocol.
Relay I/O Card	Provides additional dry contacts for other applications.
MODBUS Card	Provides MODBUS compatibility.



NOTE:

To purchase optional accessories, contact your local service personnel. To learn more about all available accessories, please refer to **8. Optional Accessories**.

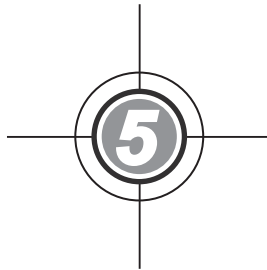

Installation and Wiring

5.1 Before Installation

5.2 Installation Environment

5.3 Transportation

5.4 Fixing the UPS

5.5 Wiring

5.6 External Battery Cabinet

5.7 Battery Module

5.8 Battery Alarm

5.9 Other Modules

5.1 Before Installation

Due to different installation environments, please read this user manual thoroughly before installation and wiring. Only authorized Delta engineers or service personnel can perform installation and maintenance. If you want to install the UPS by yourself, installation must be under the supervision of authorized Delta engineers or service personnel.

The UPS's output can connect to either the critical loads or the rack-mount PDC (optional; at maximum one). Please only choose one application. If the UPS's output connects to the rack-mount PDC (optional; at maximum one), please refer to the rack-mount PDC's user manual for relevant information about the rack-mount PDC's installation, wiring and operation.

If you use a forklift or other equipment to move the UPS, please make sure its load bearing is sufficient. Please refer to **Table 5-1**.

5.2 Installation Environment

- The UPS is designed for indoor use only. Do not install or place it in an outdoor area.
- Make sure that transportation routes (e.g. corridor, door gate, elevator, etc.) and installation area can accommodate and bear the weight of the UPS, the external battery cabinet and handling equipment. Please refer to **Table 5-1** for floor weight loading information.

Table 5-1: DPH Floor Weight Loading

DPH Series	
Rating	75kVA
Weight	921.1kg
Weight Loading	1408kg/m ²

- The UPS allows top wiring and bottom wiring. Please leave adequate space around all sides of the UPS for cable entry. To protect the UPS from overheating, wiring must not block or cover any fans of the Power Module (optional; at maximum three) and the rack-mount PDC (optional; at maximum one).
- Ensure that the installation area is big enough for maintenance and ventilation.
- It is recommended that you parallel the external battery cabinets to the UPS. The following clearances are suggested:
 1. Keep a clearance of 150cm from the front of the UPS and the external battery cabinets for maintenance and ventilation.
 2. Keep a clearance of 100cm from the back of the UPS and the external battery cabinets for ventilation.

3. Keep a clearance of 100cm from the top of the UPS for maintenance, wiring and ventilation.
- Keep the installation area's temperature around 25°C and humidity within 90%. The highest operating altitude is 1000 meters above sea level.
 - For safety concerns, we suggest that you:
 1. Equip surroundings of the installation area with CO₂ or dry powder fire extinguishers.
 2. Install the UPS in an area where the walls, floors and ceilings were constructed by fireproof materials.
 - Do not allow unauthorized personnel to enter the installation area. Assign specific personnel to keep the UPS key.

5.3 Transportation

- At the bottom of the UPS, there are four casters to help you to move the UPS to a designated area. Before you move the UPS, please turn the four leveling feet counterclockwise to raise them off the ground. This protects the leveling feet from damage when moving the UPS. Please use sufficient manpower (at least six people) and equipment (e.g. forklift) to carefully move the UPS from its pallet to ground. Please pay attention to the movement of the casters to avoid accidents.

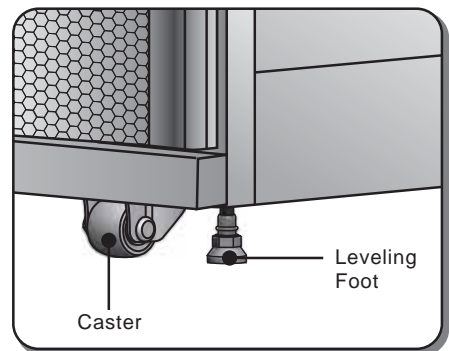

(Figure 5-1 : Leveling Foot and Caster)



WARNING!

The UPS is fixed on the pallet with four balance supports. When removing them, pay attention to the movement of the casters to avoid accidents.



REFERENCE:

Please refer to the **Unpacking Guide** attached to the UPS external wooden box for location of balance supports.

- The casters are designed to move on level ground. Do not move the UPS on an uneven surface. This might cause damage to the casters or tip the UPS which could damage the unit.

- After the UPS has been removed from the pallet to ground, we suggest that at least three people move the UPS to the installation area. One person use their hands to hold a lateral side of the UPS, one person hold the other lateral side of the UPS with their hands, and one person use their hands to push the UPS either from the front side or from the backside to move the unit to the installation area and avoid tipping the UPS.
- If you need to move the UPS over a long distance, please use appropriate equipment like a forklift. Do not use the UPS casters to move the unit over a long distance.

5.4 Fixing the UPS

Please follow the steps below:

- 1 Before fixing the UPS in a designated area, please double check whether the area's floor weight loading is sufficient to bear the UPS and external battery cabinets to avoid accidents. Please refer to **Table 5-1**.
- 2 After the UPS is moved to the designated area, stabilize the four leveling feet on the floor. Please note that the UPS must stand on the floor stably and levelly without any tipping.
- 3 Use a 16mm socket wrench and four M10 screws ❶ (originally used to fix the balance supports on the pallet) to install the two balance supports (removed during the unpacking process) at the front of the UPS. Use two expansion screws ❷ to fix the balance supports on the ground to avoid UPS movement. Service personnel should provide the expansion screws. Please see **Figure 5-2**.

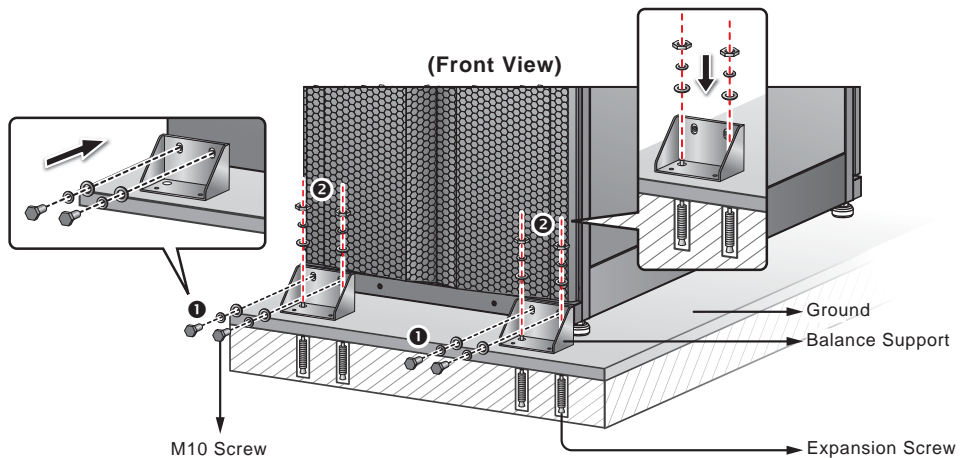

(Figure 5-2 : Balance Support Installation/ Front)

- 4 Use a 16mm socket wrench and four M10 screws ❶ (originally used to fix the balance supports on the pallet) to install the two balance supports (removed during the unpacking process) at the back of the UPS. Use two expansion screws ❷ to fix the balance supports on the ground to avoid UPS movement. Service personnel should provide the expansion screws. Please see **Figure 5-3**.

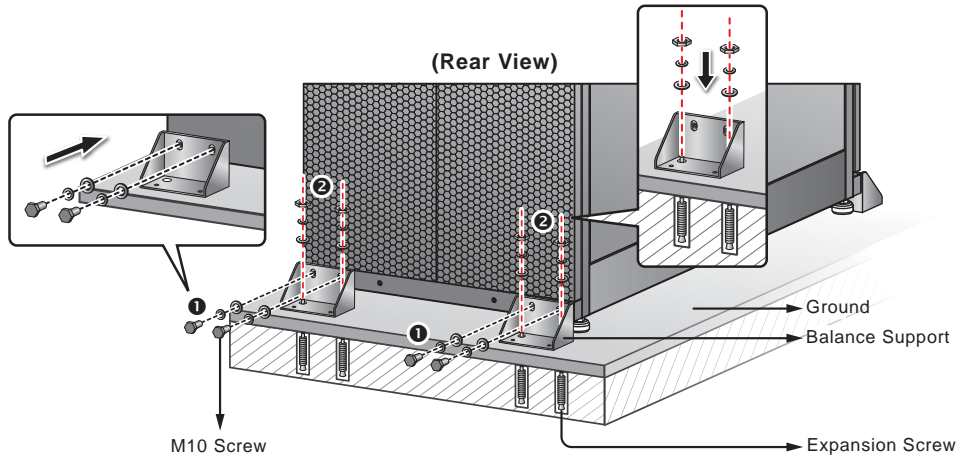

(Figure 5-3 : Balance Support Installation/ Rear)



WARNING!

It is recommended that you stabilize the UPS with the four balance supports. Otherwise, the UPS might topple over.

5.5 Wiring

5.5.1 Pre-wiring Warnings

- Before wiring or making any electrical connection, make sure the power supplied to the input and output of the UPS is completely cut off.
- During wiring procedures, please protect the UPS from foreign materials falling into the cabinet.
- The UPS's output can connect to either the critical loads or the rack-mount PDC (optional; at maximum one). Please only choose one application. If the UPS's output connects to the rack-mount PDC, please refer to the rack-mount PDC's user manual for relevant information about the rack-mount PDC's installation, wiring and operation.
- The installation of the rack-mount PDC (optional; at maximum one) must be completed before UPS wiring.
- For battery usage, the UPS can use either the external battery cabinet (at maximum four) or the battery module (optional; at maximum four). The UPS cannot use them at the same time. Please only choose one application. For more information, please refer to **5.6 External Battery Cabinet** & **5.7 Battery Module**.

- When $50\text{kVA} < \text{total load} \leq 75\text{kVA}$, the UPS must use the external battery cabinet (at maximum four) but not the battery module.

When $25\text{kVA} < \text{total load} \leq 50\text{kVA}$, the UPS can use either the external battery cabinet (at maximum four) or at least four battery modules (a battery module includes four battery boxes).

When the total load is $\leq 25\text{kVA}$, the UPS can use either the external battery cabinet (at maximum four) or at least two battery modules (a battery module includes four battery boxes).

When the UPS uses four battery modules (optional) and the total load is 50kVA, the batteries can supply power for at least 5 minutes.

- Common battery is only applicable for the external battery cabinet (at maximum four) but not for the battery module.
- The UPS allows top wiring and bottom wiring. Please leave adequate space around all sides of the UPS for cable entry. To protect the UPS from overheating, wiring must not block or cover any fans of the Power Module (optional; at maximum three) and the rack-mount PDC (optional; at maximum one).
- Check that the size, diameter, phase, and polarity are correct for each cable that needs connecting to the UPS. Please refer to **Table 5-2**.

Table 5-2: Input/ Output Electrical Data

UPS Rating	75kVA
I/P Voltage	220V/ 380V, 230V/ 400V, 240V/ 415V
O/P Voltage	220V/ 380V, 230V/ 400V, 240V/ 415V
Main Input Breaker	160A
I/P Cable	AWG 000 x 1 PC
Bypass Breaker	160A
Bypass Cable	AWG 000 x 1 PC
Output Breaker	160A
O/P Cable	AWG 000 x 1 PC
Battery Cable	AWG 000 x 1 PC
Battery Fuse	Please refer to Table 5-3 .
Grounding Cable	AWG 000 x 1 PC

**NOTE:**

1. Install suitable conduits and bushings for the input/ output cables.
 2. Please refer to national and local electrical codes for acceptable non-fuse breakers and cable sizes.
 3. PVC cables with temperature resistance up to 105°C are suggested for wiring.
 4. The tightening torque for M8 screws should be 150 ±5Kgf.cm.
 5. K.S.T SQNBS80-8 terminal is suggested for wiring.
- If the input and output wiring of the UPS adopts a Y connection, do not connect the UPS neutral (N) with the ground (⊕).
 - If there is a floating voltage between the input power's neutral (N) and the ground (⊕), and the V_{NG} of the UPS should be zero, we suggest that you install an isolation transformer in front of the input side of the UPS, and connect the UPS neutral (N) with the ground (⊕).
 - Three phases (R/ S/ T) of the AC power source must be in positive phase sequence, and R, S, T and N cables of the AC power source must be connected to the (R/ S/ T) and (N) terminals marked on the Main Input Block and the Bypass Input Block accordingly.
 - Connect positive and negative poles and the neutral terminal of an external battery cabinet to the '+', '-' and 'N' terminals marked on the Battery Input Block. Do not make a wrong connection.
 - Connect an external battery cabinet's grounding terminal to the terminal of ground (⊕). Do not connect the grounding terminal of the external battery cabinet to any other grounding system.
 - The terminal of ground (⊕) must be grounded. Please use ring-type terminals for wiring.

**WARNING!**

1. Incorrect wiring could damage the UPS or cause electric shock.
2. The UPS will not work normally if the input power's neutral (N) is not firmly connected or not connected to the Main Input Block's neutral (N) terminal.

5.5.2 Single Input/ Dual Input Modification



WARNING!

Only authorized service personnel can modify single input/ dual input configuration.

The UPS default setting is single input. If you want to modify it into dual input, please open the UPS's back doors.

Use a socket wrench to remove the four cooper bars shown in the figure below to modify the UPS into dual input.

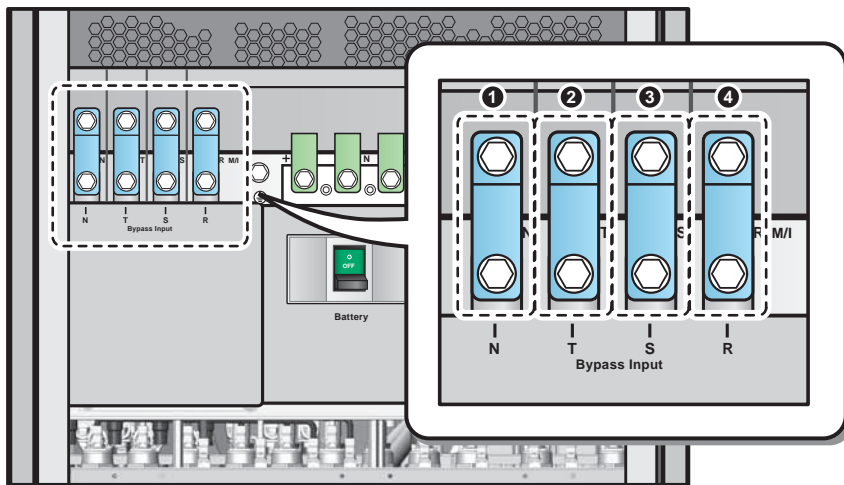

(Figure 5-4 : Four cooper Bars)



NOTE: To revert to single input, reinstall the four cooper bars.

5.5.3 Single Unit Wiring



NOTE:

1. The UPS rating voltage is 220/380Vac, 230/400Vac or 240/415Vac.
2. The external battery cabinet's rating voltage is ± 240 Vdc.
3. Before wiring, please read **5.5.1 Pre-wiring Warnings**.
4. The UPS's output can connect to either the critical loads or the rack-mount PDC (optional; at maximum one). Please only choose one application. If the UPS's output connects to the rack-mount PDC, please refer to the rack-mount PDC's user manual for relevant information about the rack-mount PDC's installation, wiring and operation.
5. After routing the cables and verifying cable connections, seal or cover the gaps between the cables and the cabinet to avoid foreign materials falling into the UPS.

• **Single Input (Single Unit)**

When there is only one AC power source, single unit wiring procedures are as follows.

1. Open the rear doors to see the UPS wiring terminal block. If you install the rack-mount PDC (optional; at maximum one) in the UPS, you can also see the rack-mount PDC's wiring terminal block. Please refer to the rack-mount PDC's user manual for relevant information about the rack-mount PDC's installation, wiring and operation.

No.	Item	Function	Description
①	Main Input Block	Connects main AC source	Includes R, S, T and Neutral (N) terminals.
②	Bypass Input Block	Connects bypass AC source	Includes R, S, T and Neutral (N) terminals.
③	⊕	For UPS grounding (safety)	Includes one grounding terminal.
④	Output Block	Connects the critical loads or the rack-mount PDC (optional; at maximum one)	Includes R, S, T and Neutral (N) terminals.
⑤	⊕	Grounding for the critical loads or the rack-mount PDC (optional; at maximum one).	Includes one grounding terminal.
⑥	Battery Input Block	Connects an external battery cabinet	Includes Positive (+), Negative (-) and Neutral (N) terminals.

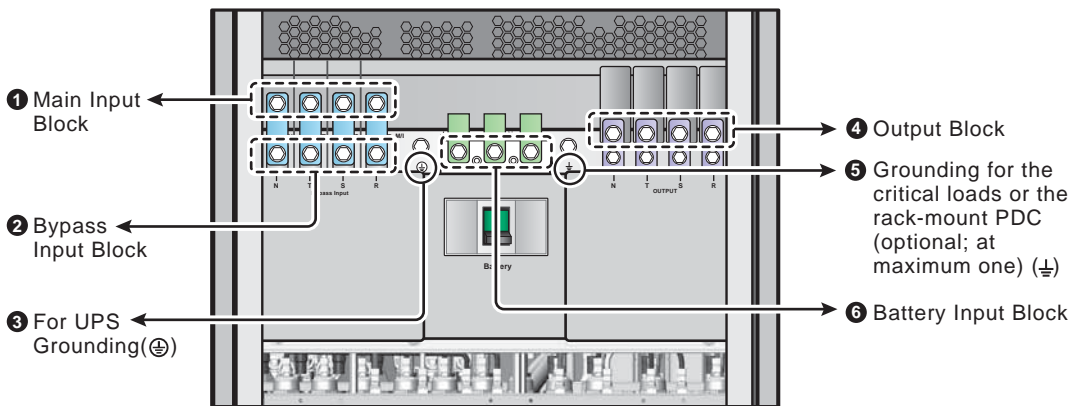

(Figure 5-5: Wiring Terminal Block)

2. Make sure the Main Input Breaker (Q1), Bypass Breaker (Q2), Manual Bypass Breaker (Q3) and Output Breaker (Q4) are in the **OFF** position.

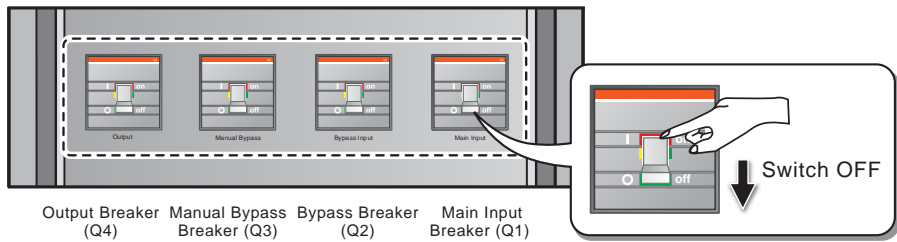

(Figure 5-6: Breaker Location)

3. Make sure the Battery Breaker (Q5) is in the **OFF** position. For the location of the Battery Breaker (Q5), please refer to **Figure 2-9**.
4. See **Table 5-2** to select suitable input/ output cables.
5. Connect the main AC source/ critical loads or rack-mount PDC (optional; at maximum one)/ external battery cabinet cables to the wiring terminal block and ground the UPS. See **Figure 5-7**. Please refer to the rack-mount PDC's user manual for relevant information about the rack-mount PDC's installation, wiring and operation. For battery usage, the UPS can use either the external battery cabinet (at maximum four) or the battery module (optional; at maximum four). The UPS cannot use them at the same time. Please only choose one application. For more information, please refer to **5.6 External Battery Cabinet & 5.7 Battery Module**.

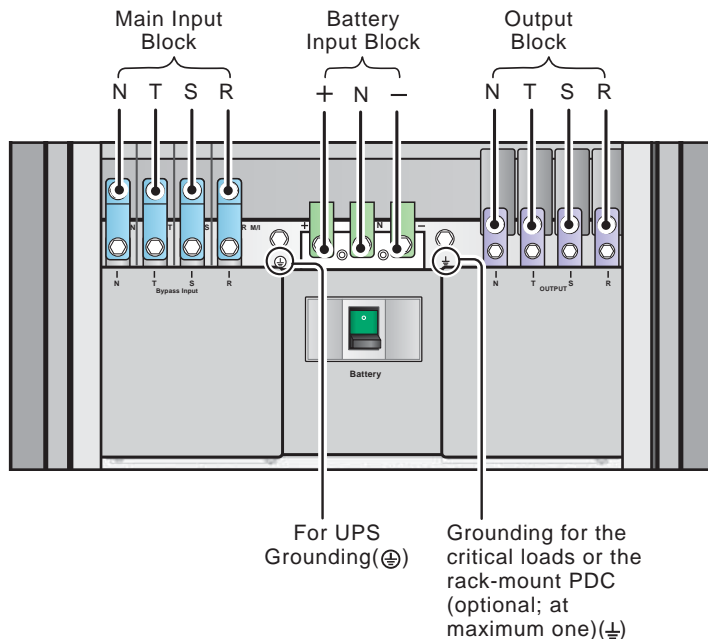

(Figure 5-7: Single Unit Single Input Wiring Diagram)

• Dual Input (Single Unit)

When there are two AC power sources, single unit wiring procedures are as follows.

1. Follow **5.5.2 Single Input/ Dual Input Modification** to modify the UPS into dual input.
2. Please refer to **step 1~4** stated in **5.5.3 Single Unit Wiring - Single Input (Single Unit)**.
3. Connect the main AC source/ bypass AC source/ critical loads or rack-mount PDC (optional; at maximum one)/ external battery cabinet cables to the wiring terminal block. Please see **Figure 5-8**. Please refer to the rack-mount PDC's user manual for relevant information about the rack-mount PDC's installation, wiring and operation. For battery usage, the UPS can use either the external battery cabinet (at maximum four) or the battery module (optional; at maximum four). The UPS cannot use them at the same time. Please only choose one application. For more information, please refer to **5.6 External Battery Cabinet & 5.7 Battery Module**.
4. Connect the bypass AC source's neutral to the Neutral (N) terminal of the Main Input Block.
5. Ground the UPS.

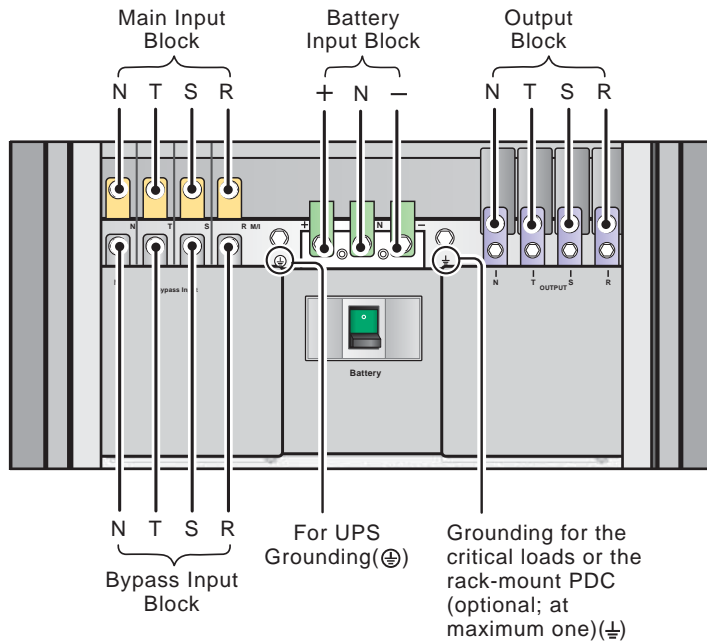

(Figure 5-8: Single Unit Dual Input Wiring Diagram)

5.5.4 Parallel Units Wiring



NOTE:

1. The UPS rating voltage is 220/380Vac, 230/400Vac or 240/415Vac.
2. The external battery cabinet's rating voltage is ± 240 Vdc.
3. Before wiring, please read **5.5.1 Pre-wiring Warnings**.
4. The UPS's output can connect to either the critical loads or the rack-mount PDC (optional; at maximum one). Please only choose one application. If the UPS's output connects to the rack-mount PDC, please refer to the rack-mount PDC's user manual for relevant information about the rack-mount PDC's installation, wiring and operation.
5. After routing the cables and verifying cable connections, seal or cover the gaps between the cables and the cabinet to avoid foreign materials falling into the UPS.

• Single Input (Parallel Units)

When there is only one AC power source, parallel units' wiring procedures are as follows.

1. Follow **step 1~4** stated in **5.5.3 Single Unit Wiring - Single Input (Single Unit)**.
2. Connect the main AC source/ critical loads or rack-mount PDC (optional; at maximum one for each UPS)/ external battery cabinet cables to the wiring terminal block. Please see **Figure 5-7** and **Figure 5-9**. Please refer to the rack-mount PDC's user manual for relevant information about the rack-mount PDC's installation, wiring and operation. For battery usage, each UPS can use either the external battery cabinet (at maximum four) or the battery module (optional; at maximum four). The UPS cannot use them at the same time. Please only choose one application. For more information, please refer to **5.6 External Battery Cabinet & 5.7 Battery Module**.
3. Use the provided parallel cable to connect the parallel ports on the parallel units. Please see **Figure 4-2** for parallel port location.
4. Ground the parallel UPSs.

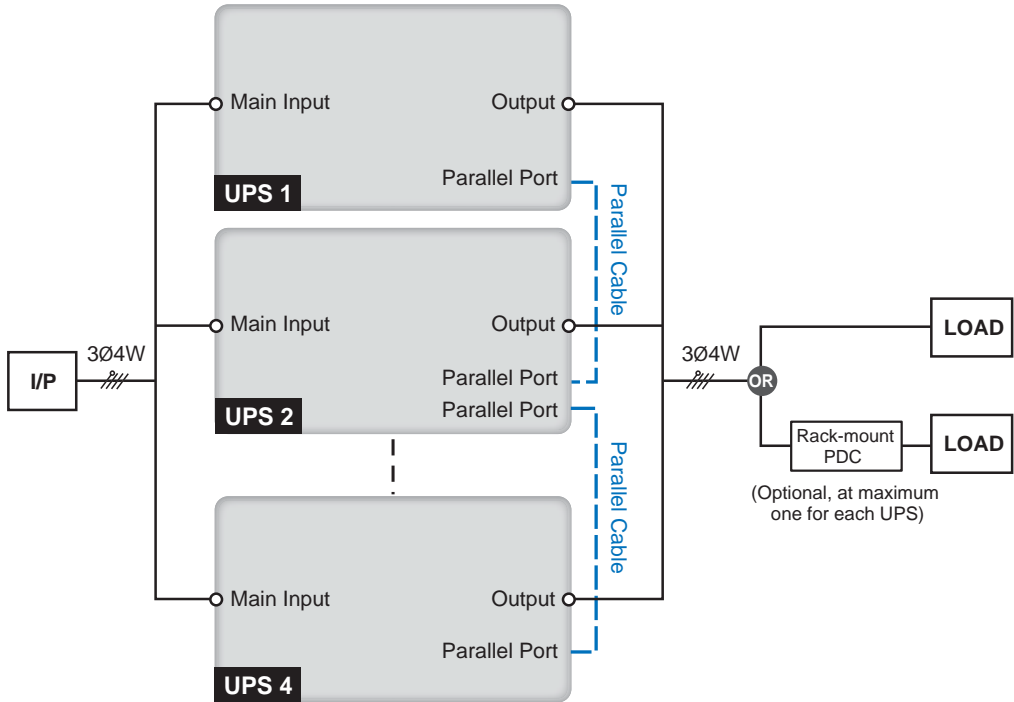

(Figure 5-9: Parallel Unit Single Input Wiring Diagram)



WARNING!

1. When UPSs are paralleled, the total length of each unit's input cables plus output cables must be equal. This ensures that the parallel UPSs can equally share the critical loads in Bypass Mode.
2. Only UPSs with the same system capacity, voltage and frequency can be paralleled; otherwise, parallel functions will fail.
3. Each paralleled UPS's power module quantity shall be equivalent or near upon equivalent.

• Dual Input (Parallel Units)

When there are two AC power sources, parallel units' wiring procedures are as follows.

1. Follow **5.5.2 Single Input/ Dual Input Modification** to modify the parallel UPSs into dual input.
2. Follow **step 1~4** stated in **5.5.3 Single Unit Wiring - Single Input (Single Unit)**.
3. Connect the main AC source/ bypass AC source/ critical loads or rack-mount PDC (optional; at maximum one for each UPS)/ external battery cabinet cables to the wiring terminal block. Please see **Figure 5-8** and **Figure 5-10**. Please refer to the rack-mount PDC's user manual for relevant information about the rack-mount PDC's installation, wiring and operation. For battery usage, each UPS can use either

the external battery cabinet (at maximum four) or the battery module (optional; at maximum four). The UPS cannot use them at the same time. Please only choose one application. For more information, please refer to **5.6 External Battery Cabinet** & **5.7 Battery Module**.

4. Connect the bypass AC source's neutral to the neutral (N) terminal of the Main Input Block.
5. Use the provided parallel cable to connect the parallel ports on the parallel units. Please see **Figure 4-2** for parallel port location.
6. Ground the parallel UPSs.

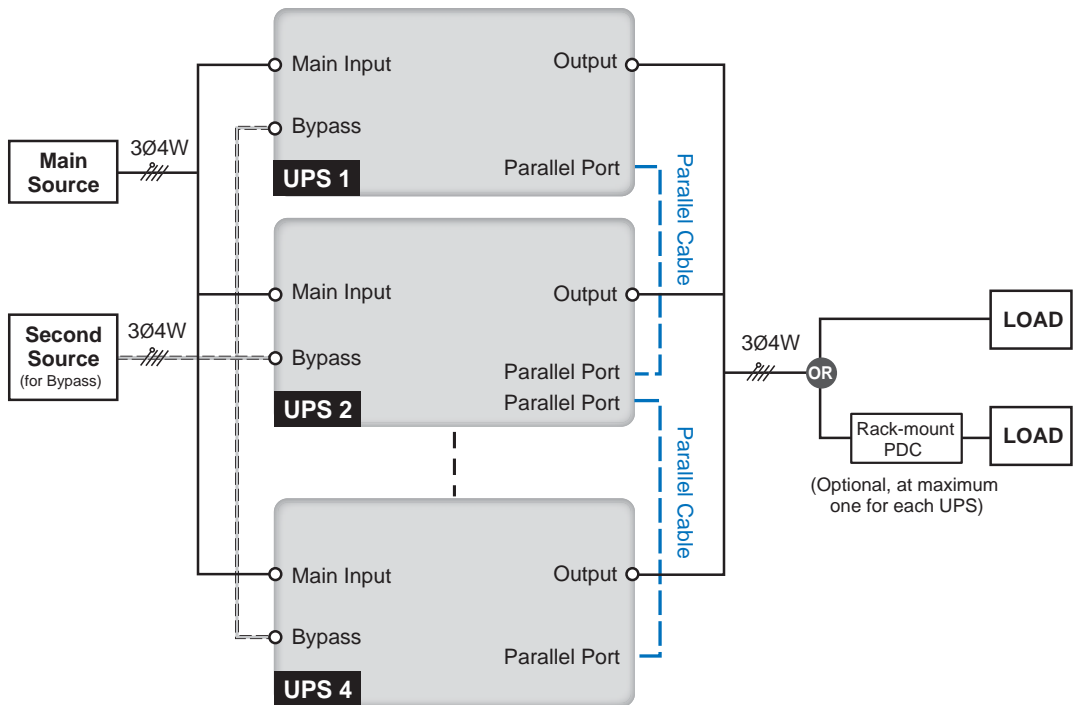

(Figure 5-10: Parallel Units Dual Input Wiring Diagram)



WARNING!

1. When UPSs are paralleled, the total length of each unit's input cables (bypass AC source) plus output cables must be equal. This ensures that the parallel UPSs can equally share the critical loads in Bypass Mode.
2. Only UPSs with the same system capacity, voltage and frequency can be paralleled; otherwise, parallel functions will fail.
3. Each paralleled UPS's power module quantity shall be equivalent or near upon equivalent.

5.6 External Battery Cabinet



WARNING!

1. For battery usage, the UPS can use either the external battery cabinet (at maximum four) or the battery module (optional; at maximum four). The UPS cannot use them at the same time. Please only choose one application. For more information, please refer to **5.6 External Battery Cabinet & 5.7 Battery Module**.
2. When $50\text{kVA} < \text{total load} \leq 75\text{kVA}$, the UPS must use the external battery cabinet (at maximum four) but not the battery module.
 When $25\text{kVA} < \text{total load} \leq 50\text{kVA}$, the UPS can use either the external battery cabinet (at maximum four) or at least four battery modules (a battery module includes four battery boxes).
 When the total load is $\leq 25\text{kVA}$, the UPS can use either the external battery cabinet (at maximum four) or at least two battery modules (a battery module includes four battery boxes).
 When the UPS uses four battery modules (optional) and the total load is 50kVA, the batteries can supply power for at least 5 minutes.
3. Common battery is only applicable for the external battery cabinet (at maximum four) but not for the battery module.

5.6.1 Usage Warnings

If an external battery cabinet is idle for more than six months, please charge its batteries at least eight hours before operation. To do so, follow the steps below.

1. Connect the UPS to an AC power source and the external battery cabinet. Please see **5. Installation and Wiring**.
2. See **6. UPS Operation** to turn on the UPS and the external battery cabinet. After the UPS is turned on, it will automatically charge the batteries.



WARNING!

You can connect the critical loads to the UPS only after the batteries are fully charged. This guarantees that the UPS can provide sufficient backup power to the connected critical loads when a power failure occurs.

• Battery

1. Charge voltage:
 - 1) Float voltage: $\pm 272\text{Vdc}$ (default)
 - 2) Boost voltage: $\pm 280\text{Vdc}$ (default)

2. Charge Current:
 - 1) Min: $\pm 5A$ (default)
 - 2) Max: $\pm 24A$ (8A \times 3) (per Power Module's Max. current: 8A)
3. Low Battery Shutdown: $\pm 200\sim 210Vdc$ (Default: 200Vdc)
4. The number of batteries: 12V \times 40 PCS.



NOTE:

1. To modify the default settings of charge current and low battery shutdown, please contact your service personnel.
 2. You can also choose 12V \times 38 PCS or 12V \times 42 PCS batteries. Please contact your service personnel for battery selection, installation and replacement.
- Only use the same type of batteries from the same supplier. Never use old, new and different Ah batteries at the same time.
 - The number of batteries must meet UPS requirements.
 - Do not connect the batteries in reverse.
 - Use a voltage meter to measure whether the total voltage, after battery connection, is around 12.5Vdc \times the total number of batteries.



NOTE:

Before replacing batteries/ battery cabinets, turn off the UPS and cut off its input power.



WARNING!

A battery can present a risk of electric shock and high short-circuit current. Only qualified service personnel can connect and replace batteries/ battery cabinets.

- When connecting the external battery cabinet to the UPS, it is compulsory to install an appropriate non-fuse DC breaker and fast-acting fuses (when short-circuit occurs, the melting current must be 5~6 times of the battery fuse's rating current).
- Please follow **Table 5-3** to select appropriate battery fuses for different rating-power UPSs.

Table 5-3: External Battery Cabinet Configuration Data

UPS Module Q'ty	Rating Power	Circuit Breaker Rating Current	Battery Cable	Battery Fuse
1	25kVA	160A	16 mm ²	160A
2	50kVA		16 mm ² x 2 pcs	
3	75kVA	225A	25 mm ² x 2 pcs	200A

- The breaker must be a 4-pole non-fuse DC breaker with characteristics of 1-pole 250Vdc, 2-pole 500Vdc, 3-pole 750Vdc and 35kA (or above) DC breaking capacity. Please follow **Figure 5-11** or **Figure 5-12** to install a 4-pole non-fuse DC breaker and fast-acting fuses between the UPS and the external battery cabinet.

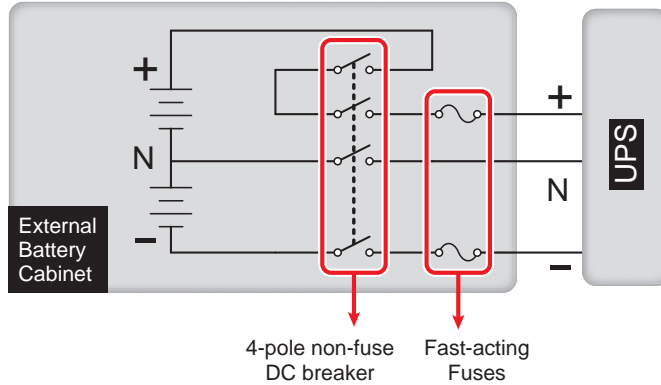

(Figure 5-11 : A 4-pole Non-fuse DC Breaker and Fast-acting Fuses Installation I)

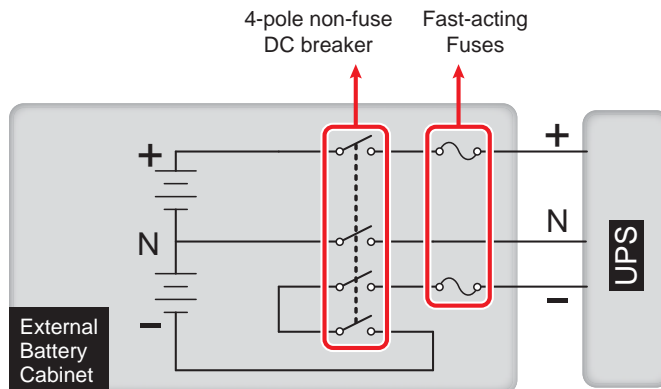

(Figure 5-12 : A 4-pole Non-fuse DC Breaker and Fast-acting Fuses Installation II)



NOTE:

An external battery cabinet shall include 40 batteries connected in string and you should connect the cabinet's neutral to the middle 20th and 21st batteries. You should use three cables to connect the external battery cabinet with the '+', '-', and 'N' terminals marked on the UPS.

When connecting the external battery cabinet with the UPS, you must install an appropriate non-fuse 4-pole DC breaker and fast-acting fuses (please refer to **Table 5-3**). Do not use an AC breaker. The closer the breaker and the fuses are to the batteries, the better. Please refer to the figure below.

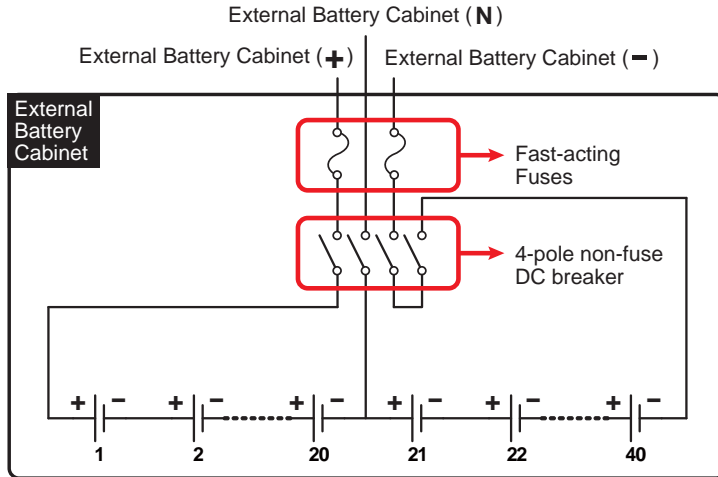

(Figure 5-13: External Battery Cabinet Connection)

5.6.2 External Battery Cabinet Wiring



WARNING!

Servicing of batteries and battery cabinets must be performed or supervised by qualified service personnel.



REFERENCE:

Please refer to **Figure 5-14** to connect an external battery cabinet to the UPS.

To save on your costs and installation space, parallel UPSs can share external battery cabinets. Please refer to **3.11 Common Battery**.

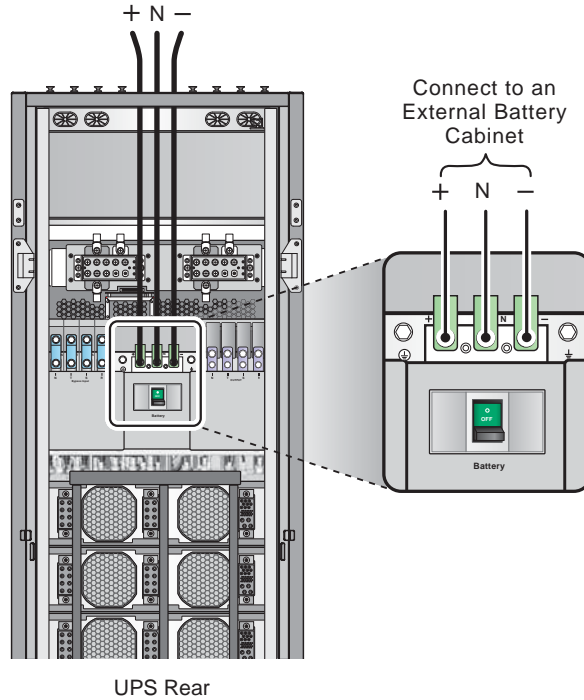

(Figure 5-14 : External Battery Cabinet Wiring)

5.7 Battery Module



WARNING!

1. For battery usage, the UPS can use either the external battery cabinet (at maximum four) or the battery module (optional; at maximum four). The UPS cannot use them at the same time. Please only choose one application. For more information, please refer to **5.6 External Battery Cabinet** & **5.7 Battery Module**.
2. When $50\text{kVA} < \text{total load} \leq 75\text{kVA}$, the UPS must use the external battery cabinet (at maximum four) but not the battery module.
 When $25\text{kVA} < \text{total load} \leq 50\text{kVA}$, the UPS can use either the external battery cabinet (at maximum four) or at least four battery modules (a battery module includes four battery boxes).
 When the total load is $\leq 25\text{kVA}$, the UPS can use either the external battery cabinet (at maximum four) or at least two battery modules (a battery module includes four battery boxes).
 When the UPS uses four battery modules (optional) and the total load is 50kVA, the batteries can supply power for at least 5 minutes.
3. Common battery is only applicable for the external battery cabinet (at maximum four) but not for the battery module.

- A battery module includes four battery boxes. You must install the four battery boxes in the same layer of the battery module slot. For the location of the battery module slot, please refer to **Figure 2-5**. Each battery box is composed of 10 sealed lead-acid 12Vdc 9Ah batteries.
- One UPS can accommodate four battery modules.
- Each battery module is protected by the relevant battery fuses. There are 16 battery fuses and each battery fuse's specification is DC 600V 30A. The battery fuses have been installed in the UPS before the UPS is shipped out of the factory. For more information about the battery fuses, please refer to **2.6.4 Battery Fuses**.

5.7.1 Battery Module Installation/ Removal



WARNING!

1. Only qualified service personnel can perform battery module installation/ replacement.
2. A battery module includes four battery boxes. Each battery box is heavy (around 32kg). At least two people are required for handling.
3. Before performing battery module installation/ replacement, make sure the Battery Breaker (Q5) is in the **OFF** position. For the location of the Battery Breaker (Q5), please refer to **Figure 2-9**.
4. Removal of the battery modules will let your critical loads not be protected once a power event occurs. Please ensure that your contrail loads are safely shutdown before removal of the battery modules.

• Install a Battery Module

1. Open the UPS's front door and follow actual needs to decide how many panels of the battery module slots that you should remove (each panel has 7 screws). Please see **Figure 5-15**.

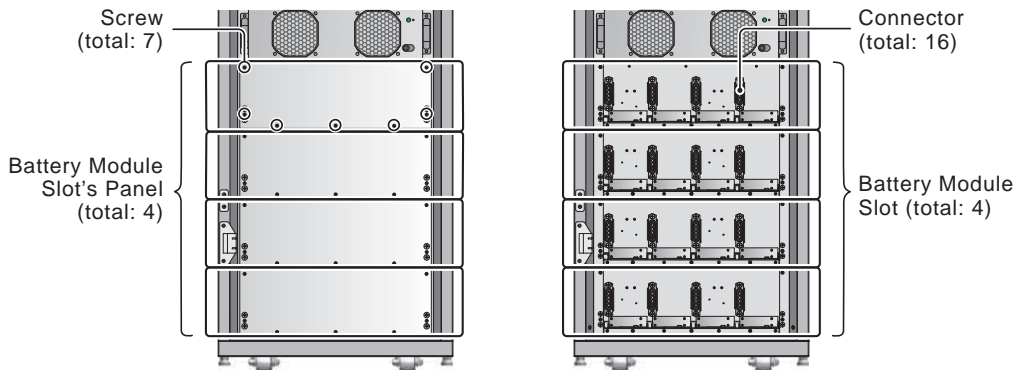

(Figure 5-15 : Remove the Panel of the Battery Module Slot)

- 2 Face the battery box's handles (see **Figure 5-16**), aim the connector locating inside the battery module slot (see **Figure 5-15** for the connector's location), insert the battery box into the rails until the battery box is well connected with the connector. A battery module includes four battery boxes, and the four battery boxes must be installed in the same layer of the battery module slot (see **Figure 5-15 & Figure 5-16**). Please follow actual needs to decide how many battery modules that you need to install.

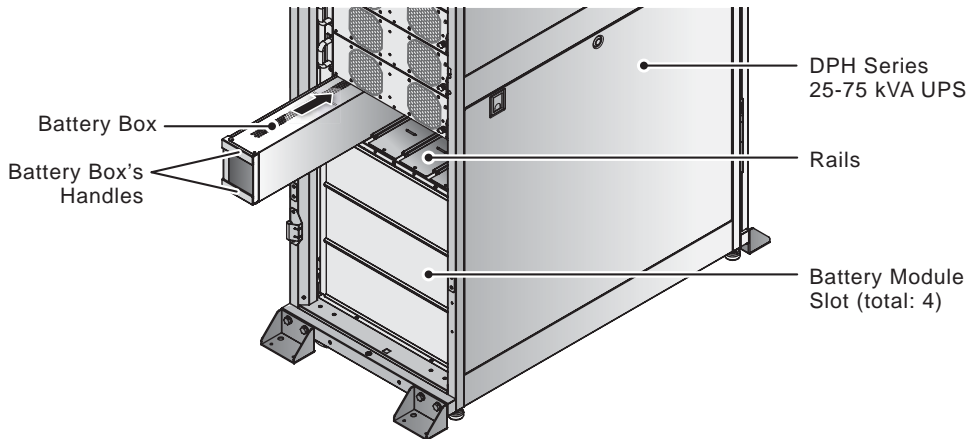

(Figure 5-16: Install a Battery Module)

- 3 Reinstall the panels (each panel has 7 screws).

• Remove a Battery Module

- 1 Open the UPS's front door and follow actual needs to decide how many panels of the battery module slots that you should remove (each panel has 7 screws). Please see **Figure 5-15**.
- 2 Hold the battery box's handles and pull out the battery box from the battery module slot. At least two people are required for handling.
- 3 Removal of any battery box will fail its battery module's function. If a battery module is not needed, please remove all of its battery boxes from the same layer of the battery module slot. This avoids from influencing other battery modules' functions.
- 4 Reinstall the panels (each panel has 7 screws).

5.8 Battery Alarm

No.	Battery Status	Alarm
1	Battery Ground Fault	Long beep
2	Battery Over Temp	Beeps every 0.5 second (ON for 0.25 second/ OFF for 0.25 second).
3	Battery Test Fail	Beeps every 10 seconds (ON for 0.5 second/ OFF for 9.5 seconds).
4	Battery Low Warning	Beeps every 0.5 second (ON for 0.25 second/ OFF for 0.25 second).
5	Battery Low Shutdown	Beeps every 3 seconds (ON for 0.5 second/ OFF for 2.5 seconds).
6	Battery Replacement	Beeps every 10 seconds (ON for 0.5 second/ OFF for 9.5 seconds).
7	Battery Over Charge	Long beep
8	Battery Missing	Beeps every 0.5 second (ON for 0.25 second/ OFF for 0.25 second).
9	Battery Breaker OFF	Beeps every 0.5 second (ON for 0.25 second/ OFF for 0.25 second).

5.9 Other Modules

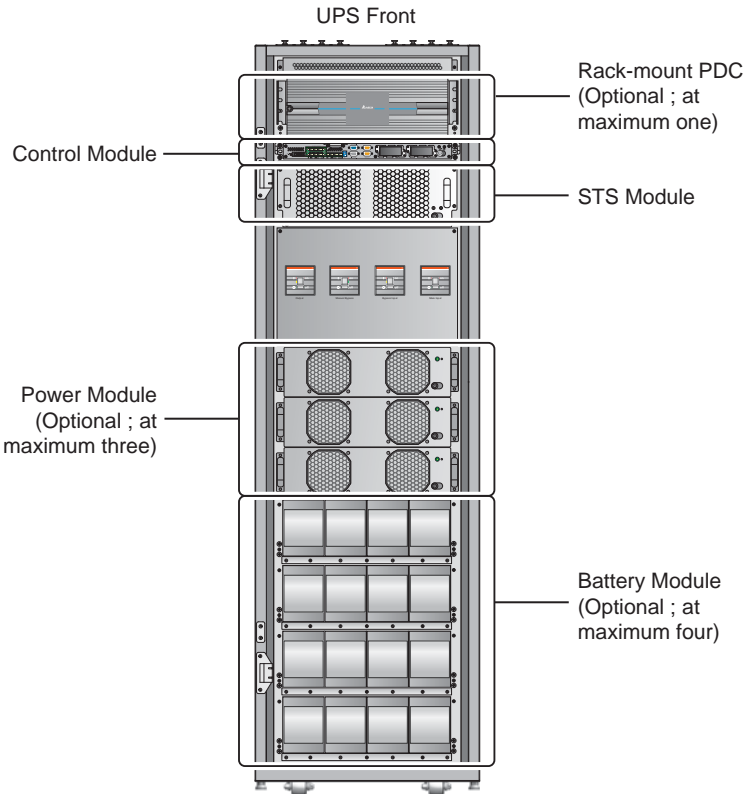

(Figure 5-17 : Internal Front View/ Modules)

5.9.1 Power Module (Optional ; at maximum three)

The Power Module is optional and you can install at maximum three in the UPS. Each Power Module has a LED indicator to show its operation status. Please refer to the following table:

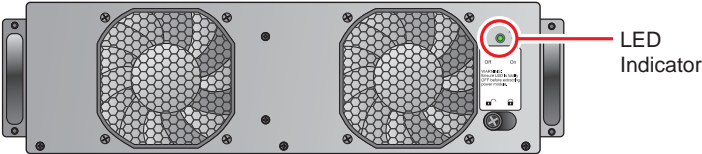

(Figure 5-18 : Power Module)

LED indicator	Description
OFF	The Power Module is OFF.
ON	The Power Module is under operation.
On : 2 seconds/ off: 1 second alternatively	The Power Module's inverter starts up.
On: 1 second/ off: 2 seconds alternatively	The Power Module's PFC starts up.
On 0.3 second/ off: 3 seconds alternatively	The Power Module is abnormal.



NOTE:

In normal mode, if you unlock and open a Power Module's latch, the Power Module will be off line and will discharge the DC BUS voltage until the voltage reaches to a safety level. After that, the LED indicator will turn off.

• **Install the Power Module**



WARNING!

1. Only qualified service personnel can perform the following procedures.
2. Each Power Module is heavy (>30 kg). At least two people are required for handling.

Please follow the instructions below to install the Power Module.

- 1 From the Power Module's package, take out the two holders and four screws shown. Fix the two holders on the two sides of the Power Module.

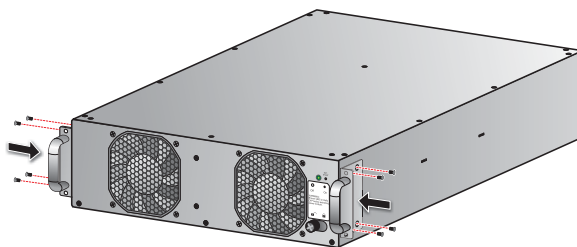

(Figure 5-19: Fix the Holders)

- 2 Two people together hold and insert the Power Module into an unoccupied slot.

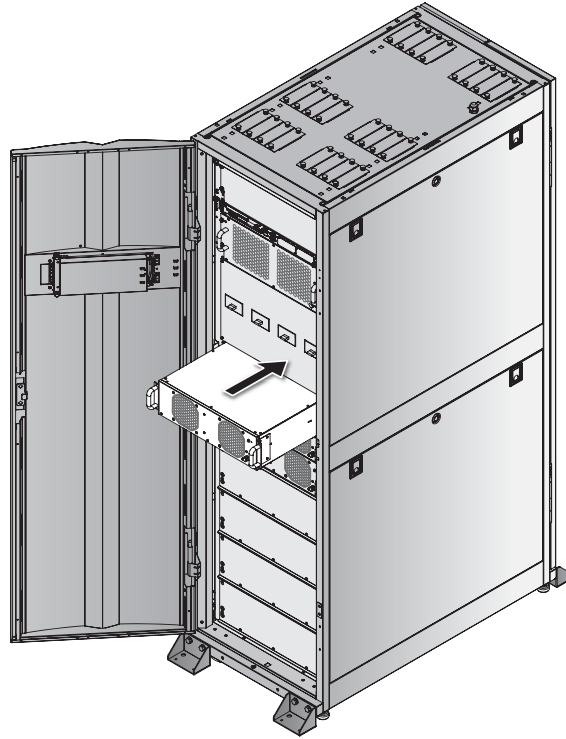

(Figure 5-20: Insert the Power Module)

- 3 Fix the Power Module in the slot with the four provided screws.

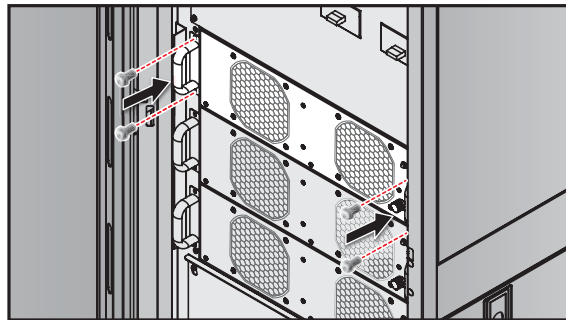

(Figure 5-21 : Fasten the Screws)

- 4 Move the latch to the  position and screw it firmly.

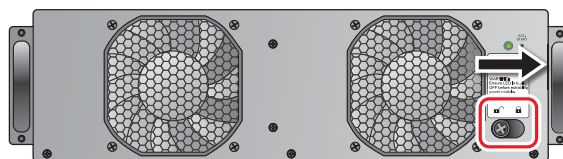

(Figure 5-22 : Lock the Latch)

- **Remove the Power Module**



WARNING!

Before removing any Power Module, make sure the remaining Power Modules can support the critical loads.

- 1 Loosen the latch knob until it pops up. Move the latch to the  position.

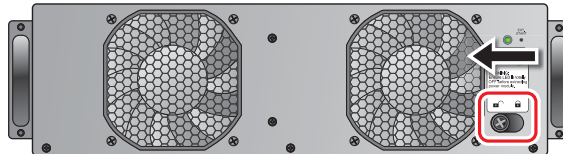

(Figure 5-23 : Unlock the Latch)

- 2 After the Power Module finishes discharging and shuts down, its LED indicator will turn off.

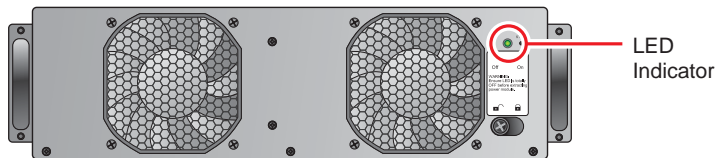

(Figure 5-24: LED Indicator)

- 3 Use a screwdriver to remove the four screws shown in the figure below.

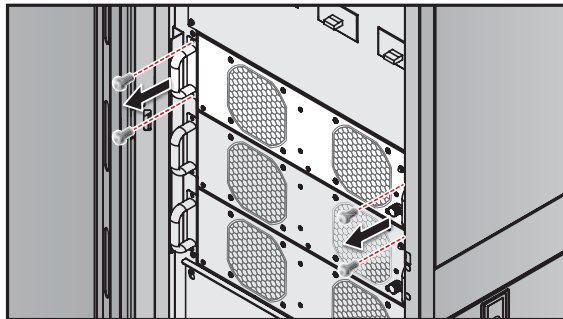

(Figure 5-25 : Remove the Four Screws)

- 4 Two people together pull out and remove the Power Module from its slot.

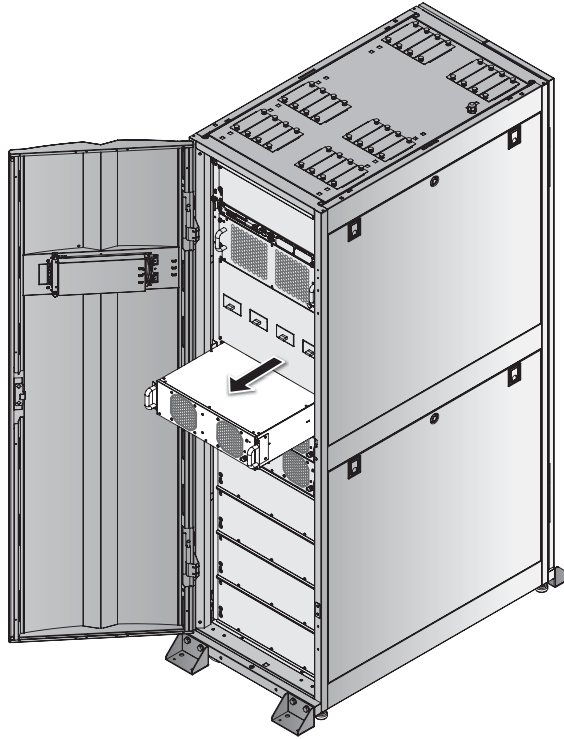

(Figure 5-26 : Remove the Power Module)

5.9.2 STS Module



WARNING!

Only qualified service personnel can perform the following procedures.

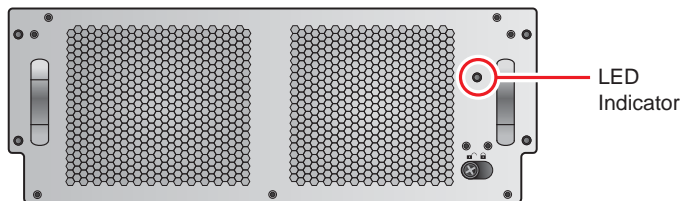

(Figure 5-27 : STS Module)

The LED indicator on the STS Module shows its operation status. See the table below:

LED indicator	Description
OFF	The STS Module is off and the bypass output is off.
ON	The STS Module is on and the bypass supplies power to the output.



NOTE:

Please note that, in Bypass Mode, unlocking the STS Module's latch won't interrupt its output, but will trigger an event warning.

• **Remove the STS Module**



WARNING!

1. Only qualified service personnel can perform the following procedures.
2. The STS Module has been installed in the factory. Only remove the STS Module when maintenance or replacement is necessary.
3. When the UPS is in Bypass Mode and its critical loads are connected, removing the STS Module without turning off the Bypass Breaker (Q2) could generate high voltage, which may melt its connectors.
4. If the UPS is in Bypass Mode, cutting off the bypass AC source will terminate power supply to the critical loads.
5. The STS Module is heavy (>30 kg). At least two people are required for handling.

Please follow the steps below to remove the STS Module.

- 1 Turn OFF the Bypass Breaker (Q2).
- 2 Loosen the STS Module's latch knob until it pops up. Move the latch to the  position.

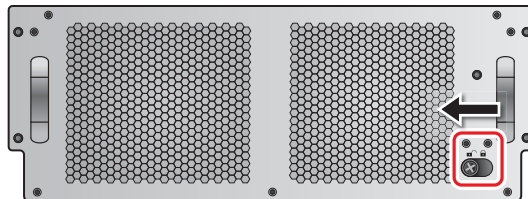

(Figure 5-28 : Unlock the Latch)

- 3 Use a screwdriver to remove the four screws from the two sides of the STS Module.

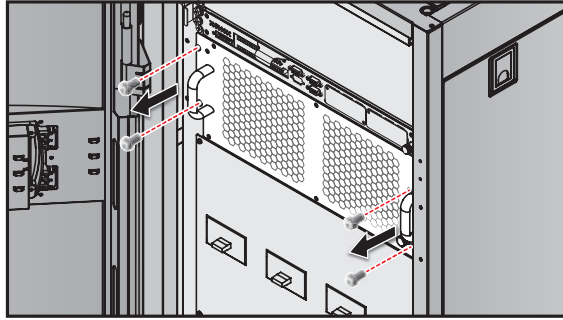

(Figure 5-29 : Remove the Screws)

- 4 Two people together pull out and remove the STS Module.

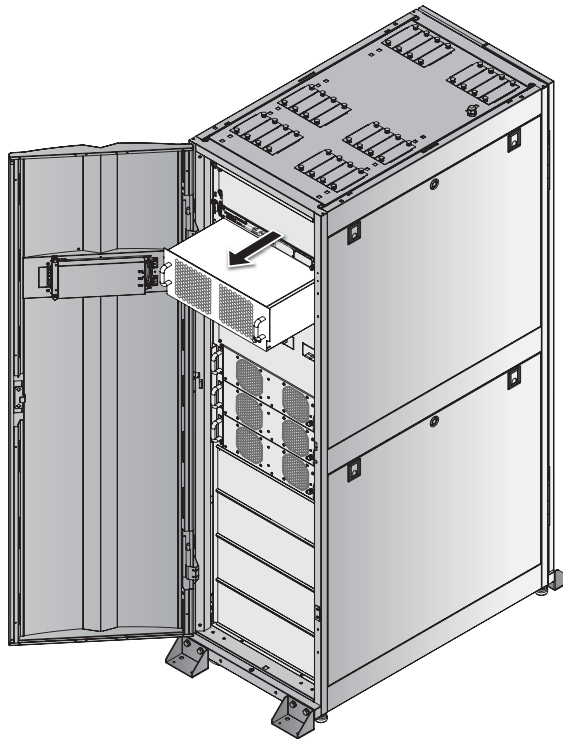

(Figure 5-30 : Remove the STS Module)



NOTE:

Reverse the steps above to insert the STS module.

5.9.3 Control Module

- Remove the Control Module



WARNING!

1. Only qualified service personnel can perform the following procedures.
2. The Control Module has been installed in the factory. Only remove the Control Module when maintenance or replacement is necessary.

Follow the steps below to remove the Control Module.

- 1 Loosen the Control Module's latch knob until it pops up. Move the latch to the  position.

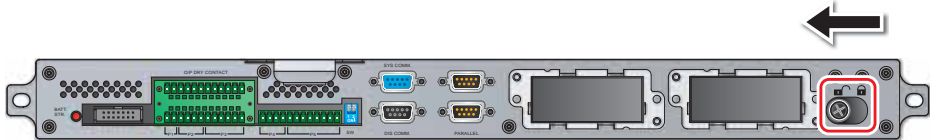

(Figure 5-30: Unlock the Latch)

- 2 Use a screwdriver to remove the two screws from the two sides of the Control Module.

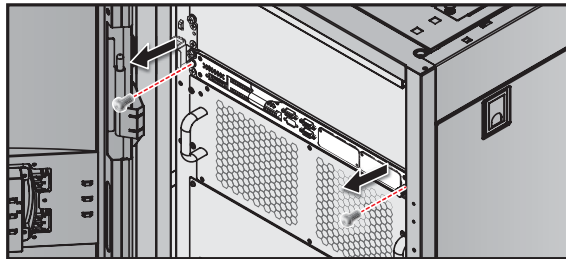

(Figure 5-31 : Remove the two Screws)

- 3 Remove the LCD cable.

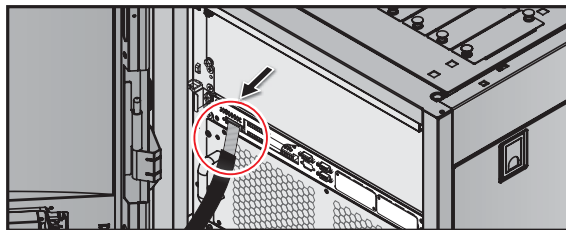

(Figure 5-32 : Remove the LCD Cable)

- 4 Pull out and remove the Control Module.

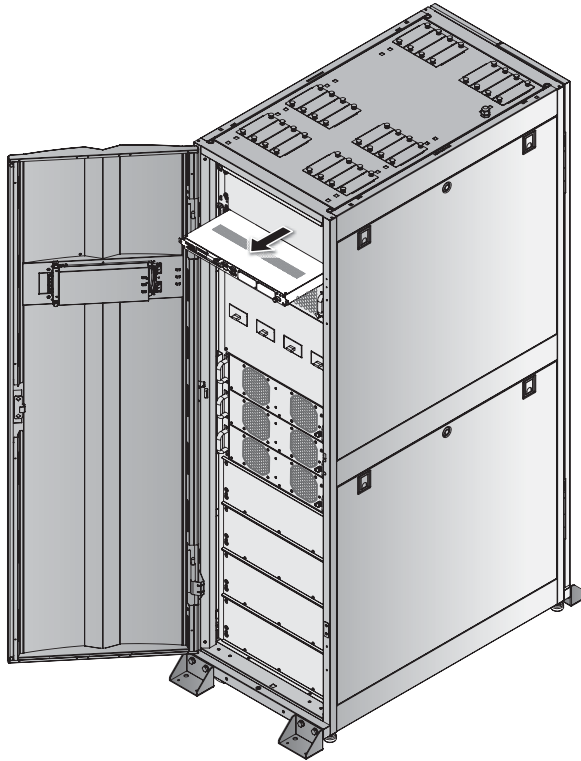

(Figure 5-33 : Remove the Control Module)



NOTE: Reverse the steps above to insert the control Module.

5.9.4 Rack-mount PDC (optional; at maximum one)

You can install at maximum one rack-mount PDC (optional) in one UPS, and each rack-mount PDC can accommodate at maximum 6 hot-swappable breaker modules (optional) and one hot-swappable control module. The rack-mount PDC provides excellent branch protection and branch monitoring functions and has the flexibility to distribute its UPS's output power according to its connected critical loads. Please refer to the rack-mount PDC's user manual for relevant information about the rack-mount PDC's installation, wiring and operation.

- **Rack-mount PDC Alarm Message**

If you install the rack-mount PDC (optional, at maximum one) in the UPS and when the rack-mount PDC has abnormalities, the relevant alarm message will appear on the LCD and the buzzer will go off. Please refer to the following table.

No.	Rack-mount PDC Alarm Message	Buzzer
1	RPDC#n Ln INPUT VOLTAGE ABNORMAL	Beeps every 0.5 second (ON for 0.25 second/ OFF for 0.25 second).
2	RPDC#n TOTAL INPUT NEUTRAL CURRENT HIGH	Beeps every 0.5 second (ON for 0.25 second/ OFF for 0.25 second).
3	RPDC#n Ln INPUT CURRENT HIGH	Beeps every 3 seconds (ON for 0.5 second/ OFF for 2.5 seconds).
4	RPDC#n Ln INPUT CURRENT IS OVER LIMIT	Beeps every 0.5 second (ON for 0.25 second/ OFF for 0.25 second).
5	RPDC#n Ln INPUT CURRENT LOW	Beeps every 10 seconds (ON for 0.5 second/ OFF for 9.5 seconds).
6	RPDC#n SYSTEM OVERLOAD	Beeps every 0.5 second (ON for 0.25 second/ OFF for 0.25 second).
7	RPDC#n SYSTEM ENVIRONMENT TEMP HIGH	Beeps every 0.5 second (ON for 0.25 second/ OFF for 0.25 second).
8	RPDC#n INPUT POWER ABNORMAL	Beeps every 0.5 second (ON for 0.25 second/ OFF for 0.25 second).
9	RPDC#n FRAM ABNORMAL	Long beep
10	RPDC#n FAN#n FAIL	Beeps every 3 seconds (ON for 0.5 second/ OFF for 2.5 seconds).
11	RPDC#n B#nn CIRCUIT BREAKER OPEN	N/A
12	RPDC#n B#nn CURRENT HIGH	Beeps every 0.5 second (ON for 0.25 second/ OFF for 0.25 second).
13	RPDC#n B#nn CURRENT LOW	Beeps every 10 seconds (ON for 0.5 second/ OFF for 9.5 seconds).
14	RPDC#n COMMUNICATION FAIL	Long beep

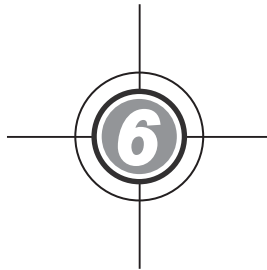

UPS Operation

6.1 Pre-operation Warnings

6.2 Single Unit Operation
Procedures

6.3 Parallel Units Operation
Procedures

6.1 Pre-operation Warnings

- Connect the UPS's output to either the critical loads or the rack-mount PDC (optional; at maximum one). Please only choose one application.
- If the UPS's output connects to the rack-mount PDC (optional; at maximum one), please refer to the rack-mount PDC's user manual for relevant information about the rack-mount PDC's installation, wiring and operation.
- All of the unit No., date, time, and event No. (e.g. 004) shown in the LCD diagrams presented in this chapter (**6. UPS Operation**) are for reference only. Actual readings depend on the operation of the UPS.
- If you install the rack-mount PDC (optional; at maximum one) in the UPS, symbols relevant to the rack-mount PDC will appear at the upper left corner of the LCD. There are three scenarios; please see below. As for the meaning of each symbol shown on the LCD, please refer to **7.2 LCD Display & Function Keys**.

A. Scenario 1:

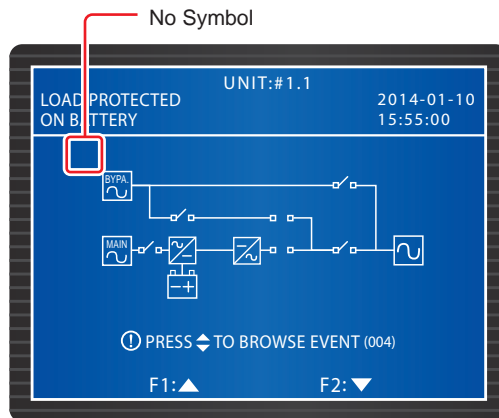



When there is no symbol at the upper left corner of the LCD (see the figure above), it means that the UPS has never communicated with the rack-mount PDC (optional; at maximum one). There are three circumstances:

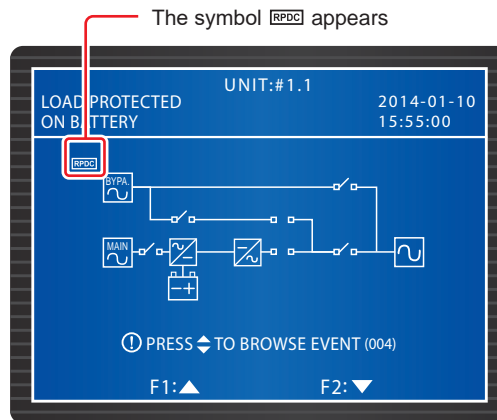

1. You didn't install any rack-mount PDC (optional; at maximum one) in the UPS.
2. You did install the rack-mount PDC (optional; at maximum one) in the UPS, but the rack-mount PDC was not turned on.
3. You did install the rack-mount PDC (optional; at maximum one) in the UPS and the rack-mount PDC was turned on, but:
 - 1) The communication cable connecting the rack-mount PDC (optional; at maximum one) and the UPS was not well connected or damaged, or
 - 2) The MCU of the rack-mount PDC (optional; at maximum one) had abnormalities.

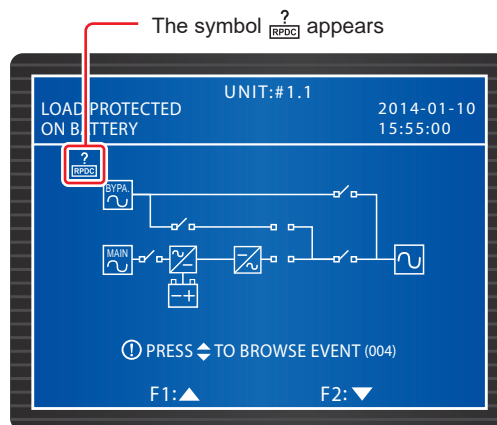
B. Scenario 2:

When the symbol  appears at the upper left corner of the LCD (see the figure above), it means the UPS successfully communicates with the rack-mount PDC (optional; at maximum one).

C. Scenario 3:

When the symbol  appears at the upper left corner of the LCD (see the figure above), it means the UPS communicated with the rack-mount PDC (optional; at maximum one) successfully before, but now, a communication abnormality has occurred and the UPS does not receive any data from the rack-mount PDC.

- In this chapter (**6. UPS Operation**), the LCD diagrams presented will not show the two symbols  and . The actual display depends on the operation of the UPS.
- For battery usage, the UPS can use either the external battery cabinet (at maximum four) or the battery module (optional; at maximum four). The UPS cannot use them at the same time. Please only choose one application. For more information, please refer to **5.6 External Battery Cabinet** & **5.7 Battery Module**.

6.2 Single Unit Operation Procedures

- **Pre Start-up Warnings for Single Unit**

1. Please refer to **6.1 Pre-operation Warnings** first.
2. Make sure all breakers (including the Battery Breaker (Q5)) of the UPS and the external battery cabinets are switched OFF.
3. Make sure the voltage difference between the Neutral (N) and Ground (\oplus) is $<1V$.
4. Check if the wiring is correct. Make sure the AC power's voltage, frequency, phase and battery type meet UPS requirements.
5. Check if the Control Module, the STS Module and all Power Modules (optional) are properly installed and their latches are locked. If you install the rack-mount PDC (optional; at maximum one) in the UPS, please ensure that the hot-swappable breaker modules (optional) and hot-swappable control module are installed in the rack-mount PDC, their latches are locked, and the rack-mount PDC wiring is correct. If you install the battery module (optional; at maximum four) in the UPS, please ensure that each battery module is well installed. For information about battery module installation, please refer to **5.7.1 Battery Module Installation/ Removal**.

- **Pre Turn-off Warnings for Single Unit**

If you perform turn-off procedures for single unit, all power supplies will be completely cut off. Please make sure the critical loads connected to the UPS have already been safely shutdown before you perform the turn-off procedures.

6.2.1 Normal Mode Start-up Procedures (Single)

- 1 Switch **ON** all external battery cabinets' breakers or the UPS's Battery Breaker (Q5). Ensure that the Manual Bypass Breaker (Q3) is OFF.
- 2 Switch ON the Bypass Breaker (Q2). After initialization, the fans of the STS Module start running, and the BYPASS LED indicator lights up.

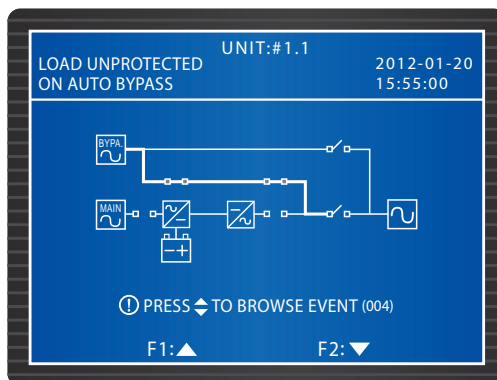

- 3 Turn ON the Output Breaker (Q4). The bypass supplies power to the output of the UPS and the LCD shows the following screen.

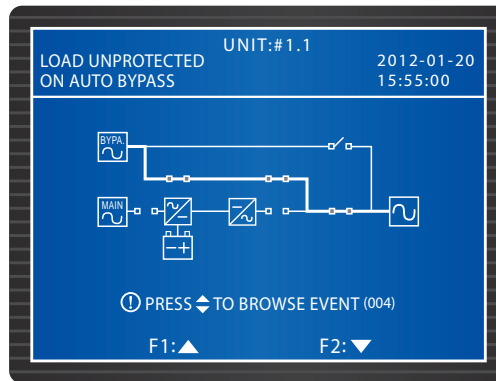

- 4 Switch ON the Main Input Breaker (Q1). Each Power Module's fans start running, each Power Module's LED indicator flashes (please refer to **5.7.1 Power Module** for LED indicator location) and DC BUS voltage starts establishing.
- 5 Press the ON button on the control panel for 3-10 seconds, release it after you hear a beep, and the following screen appears.

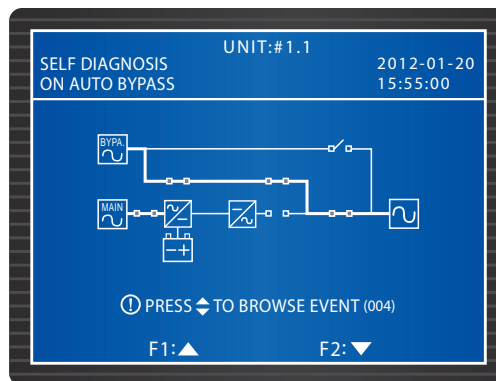

- 6 During start-up testing period, each Power Module's inverter starts up and the system begins synchronization with the bypass AC source.
- 7 After synchronization, the UPS will automatically transfer from Bypass mode to Normal Mode. In the meantime, each Power Module's LED indicator lights up, the control panel's NORMAL LED indicator illuminates and the following screen appears.
- 8 If you install the rack-mount PDC (optional; at maximum one) in the UPS, please depend on the actual requirements to turn on the breakers of the hot-swappable breaker modules installed in the rack mount PDC to let the rack-mount PDC supply power to the critical loads. All symbols relevant to the rack-mount PDC will show at the

upper left corner of the LCD; please refer to **6.1 Pre-operation Warnings**.

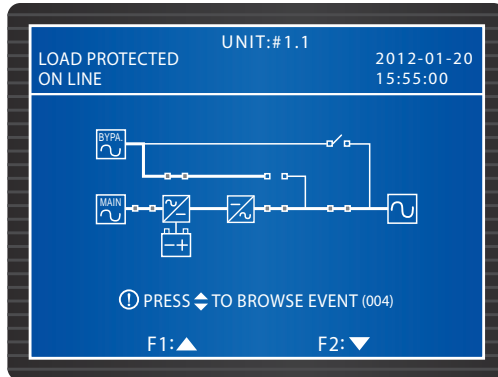

6.2.2 Battery Mode Start-up Procedures (Single)

- 1 Switch ON all external battery cabinets' breakers or the UPS's Battery Breaker (Q5). Ensure that the Manual Bypass Breaker (Q3) is OFF and the Output Breaker (Q4) is ON.
- 2 Press the **BATT STR.** button on the Control Module (see **Figure 6-1**), and the LCD is on.

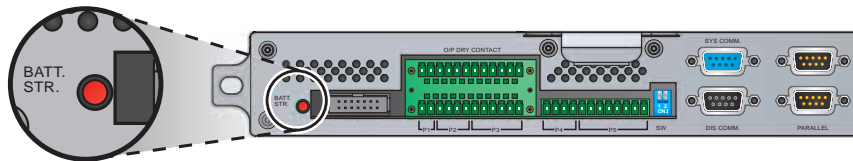

(Figure 6-1 : BATT. STR. Button)

- 3 Press the ON button on the control panel for 3-10 seconds, release it after you hear a beep, and the following screen appears.

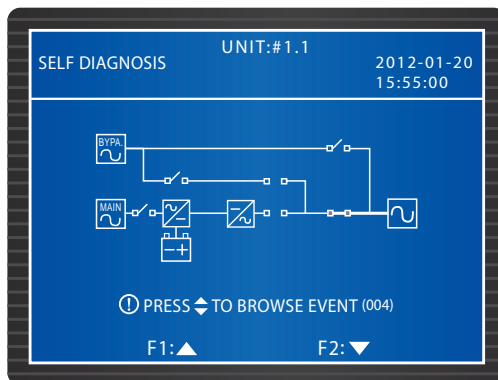

- 4 Each Power Module starts running and the DC BUS voltage starts establishing. After that, each Power Module's inverter will start up with default frequency.
- 5 After each inverter starts up, the UPS will transfer to Battery Mode. At this moment, the BATTERY LED lights up and the following screen appears.

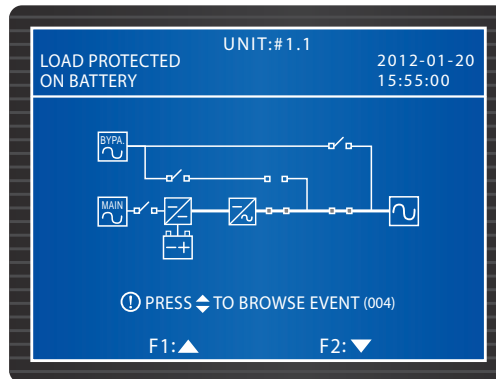

- 6 If you install the rack-mount PDC (optional; at maximum one) in the UPS, please depend on the actual requirements to turn on the breakers of the hot-swappable breaker modules installed in the rack mount PDC to let the rack-mount PDC supply power to the critical loads. All symbols relevant to the rack-mount PDC will show at the upper left corner of the LCD; please refer to **6.1 Pre-operation Warnings**.

6.2.3 Bypass Mode Start-up Procedures (Single)

- 1 Switch ON the Bypass Breaker (Q2). After initialization, the STS Module's fans start running, its LED indicator lights up (please refer to **5.7.2 STS Module** for LED indicator location), and the following screen appears.

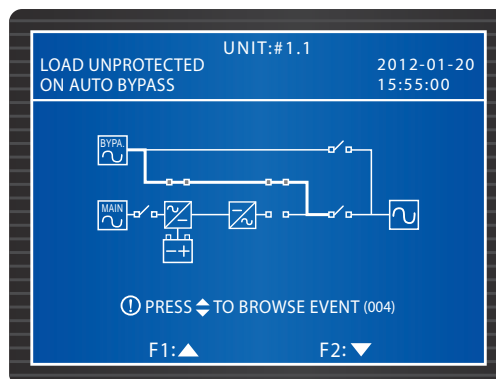

- 2 Turn ON the Output Breaker (Q4). The bypass supplies power to the output and following screen appears.

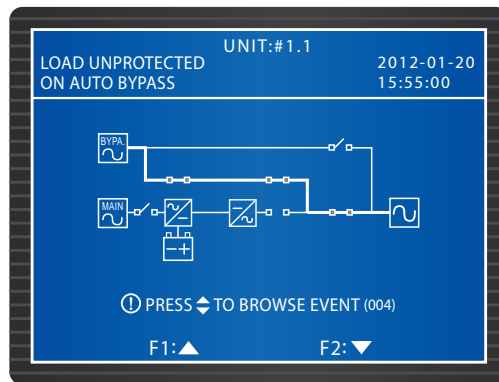

- 3 If you install the rack-mount PDC (optional; at maximum one) in the UPS, please depend on the actual requirements to turn on the breakers of the hot-swappable breaker modules installed in the rack mount PDC to let the rack-mount PDC supply power to the critical loads. All symbols relevant to the rack-mount PDC will show at the upper left corner of the LCD; please refer to **6.1 Pre-operation Warnings**.

6.2.4 Manual Bypass Mode Start-up Procedures (Single Unit)



WARNING!

1. Please note that you can only turn on the Manual Bypass Breaker (Q3) when the UPS needs maintenance. This ensures that the supply of power to the critical loads will continue. If you turn on the Manual Bypass Breaker (Q3) during normal mode, the inverter will shut down, the UPS will transfer from normal mode to manual bypass mode, and the output won't be protected.
2. In manual bypass mode, the manual bypass supplies power to the critical loads and maintenance personnel can perform maintenance without interrupting the power supply to the critical loads.
3. When the UPS is in manual bypass mode, there is no high voltage inside the UPS except the wiring terminal block, the Manual Bypass Breaker (Q3), the Battery Breaker (Q5) and the rack-mount PDC (optional; at maximum one). Do not touch the wiring terminal block, the Manual Bypass Breaker (Q3), the Battery Breaker (Q5) and the rack-mount PDC (optional; at maximum one) to avoid electrical shock.

- **From Normal Mode to Manual Bypass Mode (Single)**

1 In Normal Mode, the LCD shows the following screen:

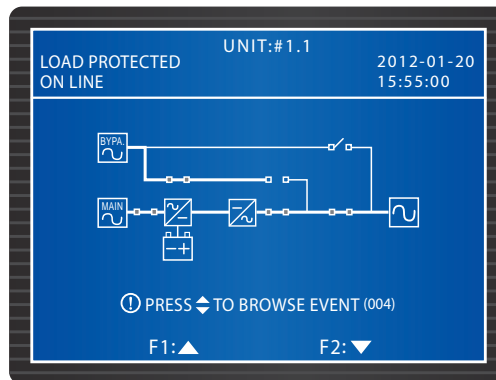

2 Press the OFF button on the control panel for three seconds and release it after you hear a beep. The LCD will show the message: **"SHUTDOWN UPS?"**. Select **"YES"** and press the \blackleftarrow key to confirm your selection. At this moment, the UPS transfers to bypass mode, the BYPASS LED lights up and the following screen appears.

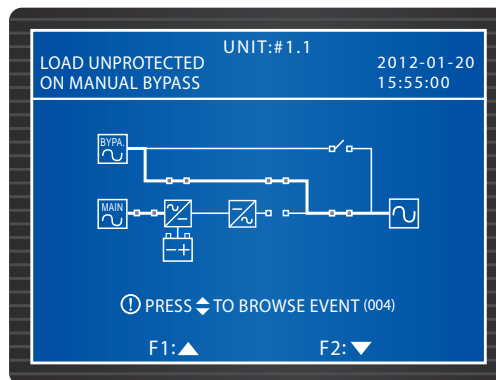

3 Switch ON the Manual Bypass Breaker (Q3). Switch OFF the Main Input Breaker (Q1), the Bypass Breaker (Q2) and the Output Breaker (Q4). All LED indicators are OFF and the following screen appears.

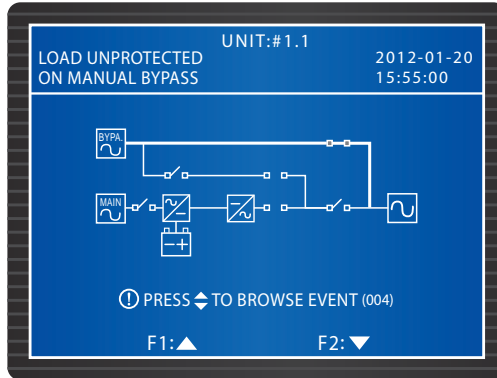

- 4) When the UPS performs DC Bus discharging, each Power Module's LED indicator flashes. After discharging, the UPS shuts down and the LCD is off.
- 5) Switch **OFF** all external battery cabinets' breakers or the UPS's Battery Breaker (Q5).

• **From Manual Bypass Mode to Normal Mode (Single)**

- 1) Switch ON the Bypass Breaker (Q2) and the Output Breaker (Q4). After initialization, the fans of the STS Module start running.
- 2) Switch OFF the Manual Bypass Breaker (Q3). The bypass supplies power to the critical loads, the BYPASS LED indicator lights up, and the following screen appears.

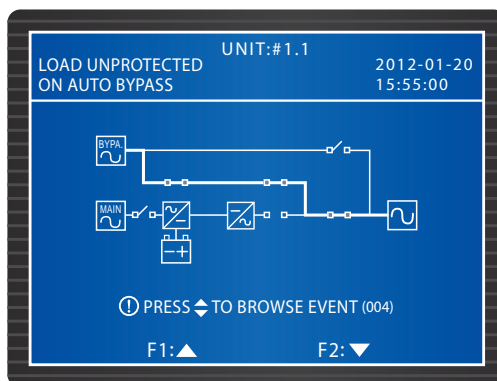

- 3) Switch ON all external battery cabinets' breakers or the UPS's Battery Breaker (Q5).
- 4) Switch ON the Main Input Breaker (Q1). Each Power Module's fans start running, the DC BUS voltage start establishing, and the following screen appears.

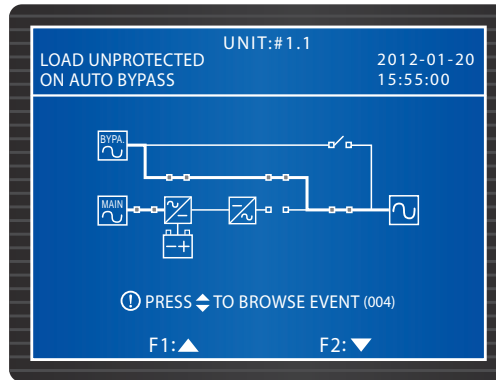

- 5 Press the ON button on the control panel for 3-10 seconds, release it after you hear a beep, and the following screen appears.

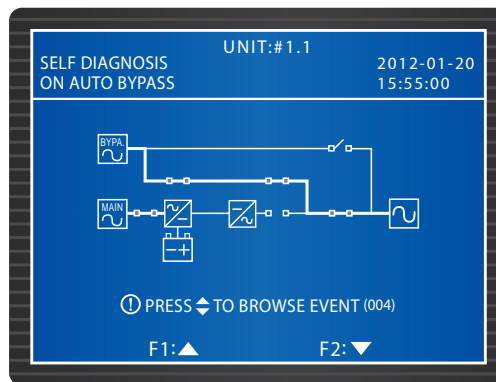

- 6 During start-up testing period, each Power Module's inverter starts up and the system begins synchronization with the bypass AC source.
- 7 After synchronization, the UPS will automatically transfer from Bypass mode to Normal Mode. In the meantime, each Power Module's LED indicator lights up, the control panel's NORMAL LED indicator illuminates and the following screen appears.

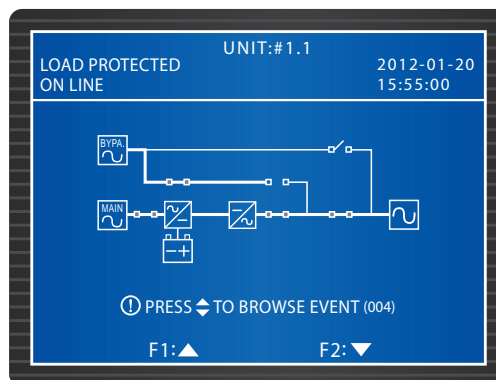

6.2.5 Normal Mode Turn-off Procedures (Single)

- 1 If you install the rack-mount PDC (optional; at maximum one) in the UPS, please turn off the breakers of each hot-swappable breaker module installed in the rack mount PDC. All symbols relevant to the rack-mount PDC will show at the upper left corner of the LCD; please refer to **6.1 Pre-operation Warnings**.
- 2 Press the OFF button on the control panel for three seconds and release it after you hear a beep. The LCD will show the message: “**SHUTDOWN UPS?**”. Select “**YES**” and press the **←** key to confirm your selection.
- 3 At this moment, the UPS transfers to bypass mode, the BYPASS LED lights up and the following screen appears.

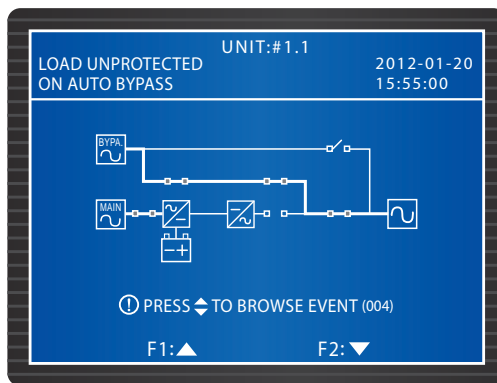

- 4 Switch OFF the Main Input Breaker (Q1). Each Power Module starts discharging and its LED indicator flashes.
- 5 Switch OFF the Bypass Breaker (Q2) and the Output Breaker (Q4). After each Power Module finishes discharging, all LED indicators and the LCD are off.
- 6 Switch **OFF** all external battery cabinets' breakers or the UPS's Battery Breaker (Q5).

6.2.6 Battery Mode Turn-off Procedures (Single)

- 1 If you install the rack-mount PDC (optional; at maximum one) in the UPS, please turn off the breakers of each hot-swappable breaker module installed in the rack mount PDC. All symbols relevant to the rack-mount PDC will show at the upper left corner of the LCD; please refer to **6.1 Pre-operation Warnings**.
- 2 In Battery Mode, the BATTERY LED lights up. Press the OFF button on the control panel for three seconds and release it after you hear a beep. The LCD will show the message: “**SHUTDOWN UPS?**”. Select “**YES**” and press the **←** key to confirm your selection.

- 3 The UPS shuts down the inverter and cuts off its output, and the LCD shows the following screen.

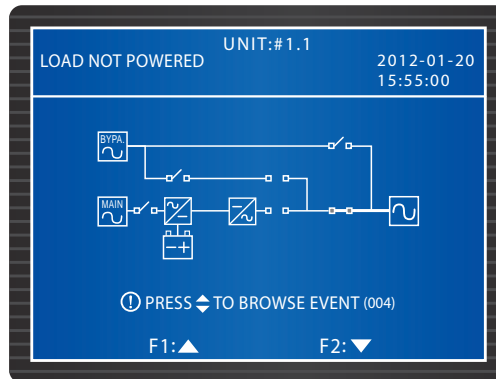

- 4 Each Power Module starts discharging and its LED indicator flashes. After discharging, each Power Module will shut down.
- 5 Switch OFF the Output Breaker (Q4). All LED indicators are off, and after 30 seconds, the LCD shuts down.
- 6 Switch **OFF** all external battery cabinets' breakers or the UPS's Battery Breaker (Q5).

6.2.7 Bypass Mode Turn-off Procedures (Single)

- 1 If you install the rack-mount PDC (optional; at maximum one) in the UPS, please turn off the breakers of each hot-swappable breaker module installed in the rack mount PDC. All symbols relevant to the rack-mount PDC will show at the upper left corner of the LCD; please refer to **6.1 Pre-operation Warnings**.

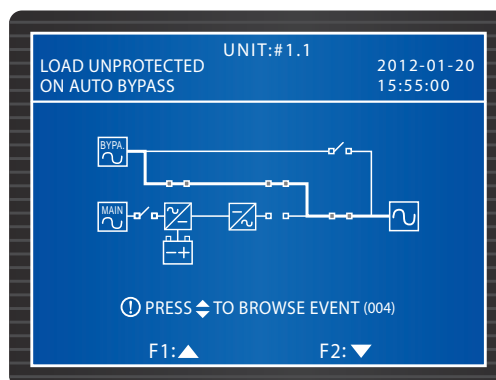

- 2 In Bypass Mode, the BYPASS LED indicator is on. Switch OFF the Bypass Breaker (Q2) and the Output Breaker (Q4). All LED indicators and the LCD are off.

6.2.8 Manual Bypass Mode Turn-off Procedures (Single)

- ① If you install the rack-mount PDC (optional; at maximum one) in the UPS, please turn off the breakers of each hot-swappable breaker module installed in the rack mount PDC.
- ② In Manual Bypass Mode, the LCD and all LED indicators are off. To completely shut down the UPS, switch OFF the Manual Bypass Breaker (Q3).

6.3 Parallel Unit Operation Procedures

• Pre Start-up Warnings for Parallel Units

1. Please refer to **6.1 Pre-operation Warnings first**.
2. Make sure all breakers (including the Battery Breaker (Q5) of each UPS and the external battery cabinets are switched **OFF**.
3. Make sure the voltage difference between the Neutral (N) and Ground (\oplus) is $<1V$.
4. Check if the wiring is correct. Make sure that the AC power's input voltage, frequency, phase and battery type meet UPS requirements.
5. Before paralleling UPSs, make sure each UPS's system capacity, voltage and frequency are the same.
6. Before paralleling UPSs, make sure that each paralleled UPS's power module quantity is equivalent or near upon equivalent.
7. Check if the Control Module, the STS Module and all Power Modules (optional) are properly installed and their latches are locked. If you install the rack-mount PDC (optional; at maximum one) in the UPS, please ensure that the hot-swappable breaker modules (optional) and hot-swappable control module are installed in the rack-mount PDC, their latches are locked, and the rack-mount PDC wiring is correct. If you install the battery module (optional; at maximum four) in the UPS, please ensure that each battery module is well installed. For information about battery module installation, please refer to **5.7.1 Battery Module Installation/ Removal**.
8. Use the provided parallel cable to connect the UPSs and make sure the parallel cable is firmly fixed.
9. If you want to parallel UPSs (at maximum four), you should use the control panel to set each UPS's PARALLEL GROUP and PARALLEL ID. Please see **7.7.5 Parallel Setup**.
10. When paralleling UPSs, you should set up the DIP switches marked in the circle shown in **Figure 6-2**. To turn on a DIP switch, set the DIP switch to the down position. To turn off a DIP switch, set the DIP switch to the up position.
 - 1) When two UPSs are paralleled, turn on each UPS's DIP switches.
 - 2) When three UPSs are paralleled, turn off the middle UPS's DIP switches and turn on the remaining UPSs' DIP switches.

- 3) When four UPSs are paralleled, turn off the middle two UPSs' DIP switches and turn on the remaining UPSs' DIP switches.

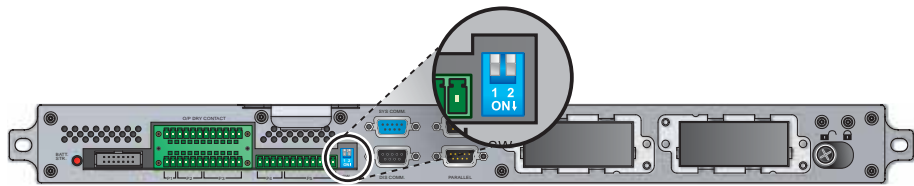

(Figure 6-2: DIP Switches Location)

• Pre Turn-off Warnings for Parallel Units

1. If you want to turn off one of the parallel UPSs, please check whether the remaining parallel UPSs' total capacity exceeds the total critical loads. If the remaining parallel UPSs' total capacity is less than the total critical loads, it will be the bypass that supplies power to the critical loads. Once a power event occurs, your critical loads won't be protected.
2. If you perform turn-off procedures for all parallel UPSs, all power supplies will be completely cut off. Please make sure the critical loads connected to the parallel UPSs have already been safely shutdown before you perform the turn-off procedures.

6.3.1 Normal Mode Start-up Procedures (Parallel)

- 1 Switch **ON** each UPS's external battery cabinets' breakers or each UPS's Battery Breaker (Q5).
- 2 Turn on each UPS's Bypass Breaker (Q2). After initialization, the fans of each unit's STS Module start running, each unit's BYPASS LED indicator lights up, and the following screen appears on each unit's LCD.

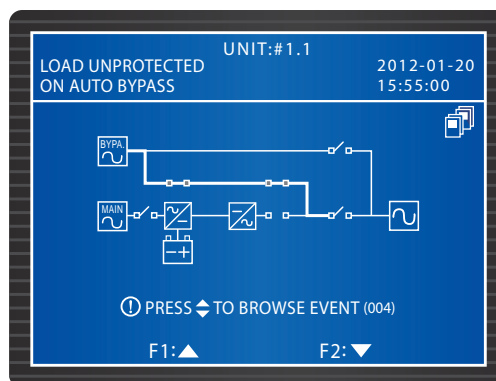

- 3 Turn on each UPS's Main Input Breaker (Q1). The fans of each unit's Power Modules start running, each unit's DC BUS voltage starts establishing, and the following screen appears on each unit's LCD.

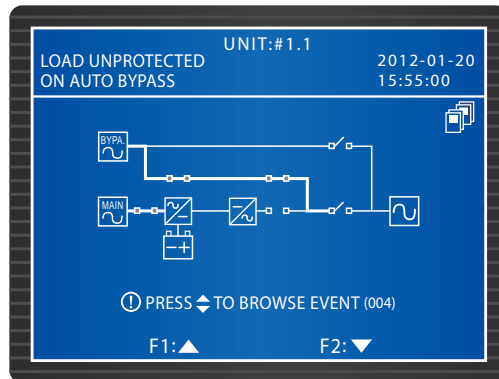

- 4 Press each UPS's ON button for 3~10 seconds and release it after you hear a beep. Each unit's inverter starts up, each UPS runs in Bypass Mode, and the following screen appears on each unit's LCD.

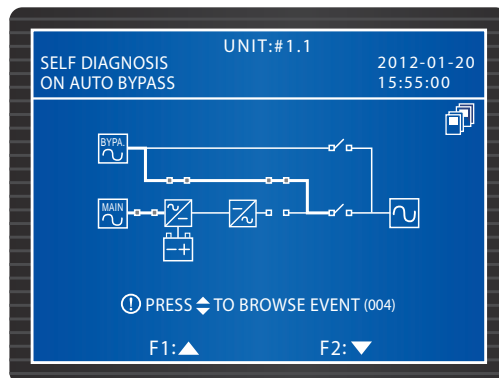

- 5 After each UPS's inverter voltage establishes, all parallel UPSs will transfer to Normal Mode. At this moment, each UPS's NORMAL LED lights up and each UPS's LCD shows the following screen.

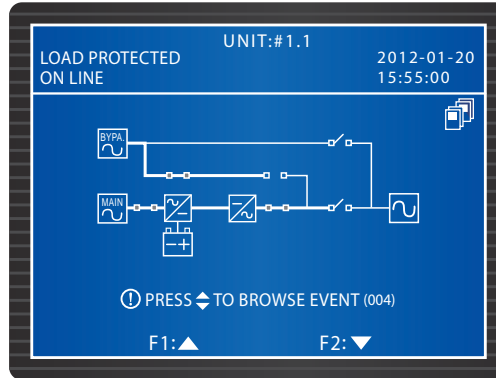

- 6 Measure each UPS's voltage difference between phases (should be below 5V). If normal, turn on each UPS's Output Breaker (Q4). At this moment, each unit's LCD shows the following screen. If abnormal, please contact service personnel.

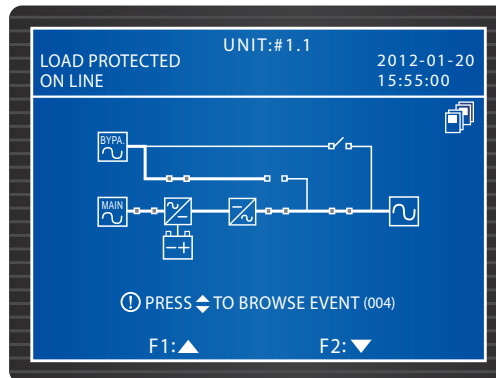

- 7 After you complete above procedures, each UPS's NORMAL LED lights up.
- 8 If you install the rack-mount PDC (optional; at maximum one) in the UPS, please depend on the actual requirements to turn on the breakers of the hot-swappable breaker modules installed in each UPS's rack-mount PDC to let the rack-mount PDC supply power to the critical loads. All symbols relevant to the rack-mount PDC will show at the upper left corner of the LCD; please refer to **6.1 Pre-operation Warnings**.

6.3.2 Battery Mode Start-up Procedures (Parallel)

- 1 Switch **ON** each UPS's external battery cabinets' breakers or each UPS's Battery Breaker (Q5). Make sure each UPS's Manual Bypass Breaker (Q3) is OFF.
- 2 Press the **BATT STR.** button on the Control Module (see **Figure 6-1**), and the LCD is on.

- 3 Press each UPS's ON button for 3~10 seconds and release it after you hear a beep. The following screen appears on each unit's LCD.

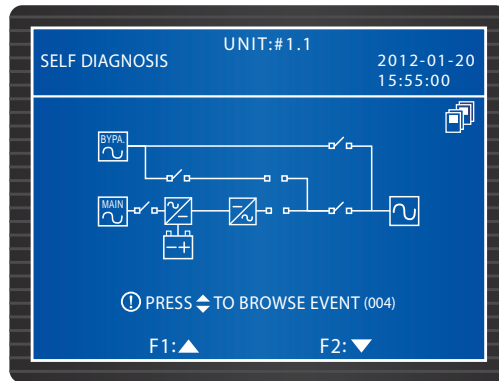

- 4 Each unit's Power Modules start running, DC BUS voltage begins establishing, and each Power Module's inverter starts up with the default frequency.
- 5 After each inverter starts up, each UPS will transfer into Battery Mode. At this moment, each Power Module's LED indicator lights up and the following screen appears on each unit's LCD.

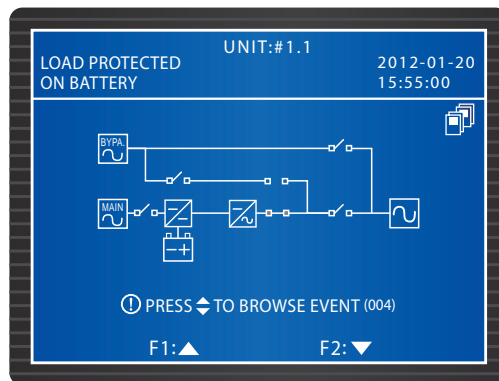

- 6 Measure each UPS's voltage difference between phases (should be below 5V). If normal, turn on each UPS's Output Breaker (Q4). At this moment, each unit's LCD shows the following screen. If abnormal, please contact service personnel.

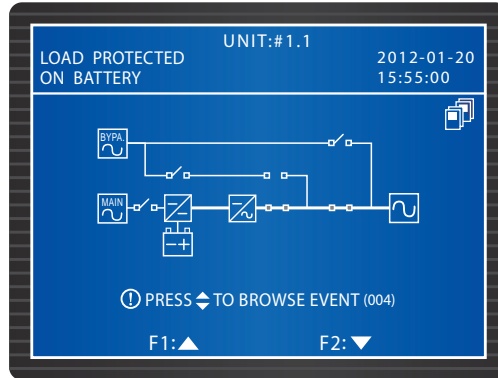

- 7) After you complete above procedures, each UPS's BATTERY LED lights up.
- 8) If you install the rack-mount PDC (optional; at maximum one) in the UPS, please depend on the actual requirements to turn on the breakers of the hot-swappable breaker modules installed in each UPS's rack-mount PDC to let the rack-mount PDC supply power to the critical loads. All symbols relevant to the rack-mount PDC will show at the upper left corner of the LCD; please refer to **6.1 Pre-operation Warnings**.

6.3.3 Bypass Mode Start-up Procedures (Parallel)

- 1) Switch ON each UPS's Bypass Breaker (Q2). After initialization, each Power Module's fans start running, each UPS's BYPASS LED lights up and the following screen appears on each unit's LCD.

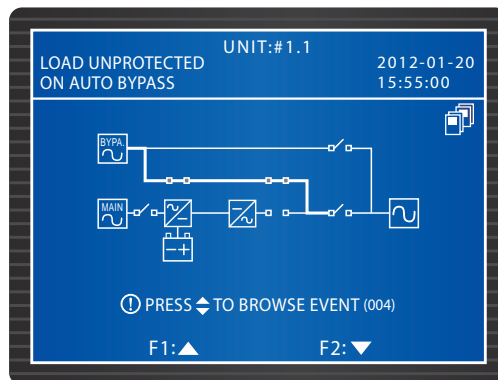

- 2) Turn on each unit's Output Breaker (Q4). Each unit's LCD shows the following screen and the bypass supplies power to the output.

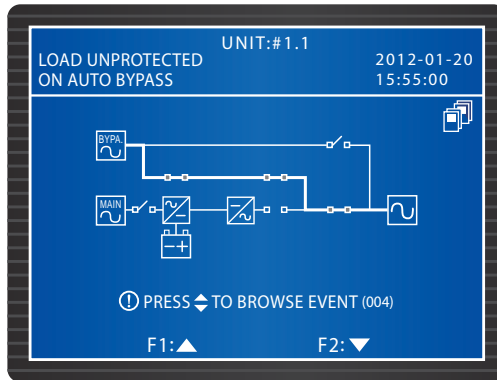

- 3 After you complete above procedures, each UPS's BYPASS LED lights up.
- 4 If you install the rack-mount PDC (optional; at maximum one) in the UPS, please depend on the actual requirements to turn on the breakers of the hot-swappable breaker modules installed in each UPS's rack-mount PDC to let the rack-mount PDC supply power to the critical loads. All symbols relevant to the rack-mount PDC will show at the upper left corner of the LCD; please refer to **6.1 Pre-operation Warnings**.

6.3.4 Manual Bypass Mode Start-up Procedures (Parallel)



WARNING!

1. Please note that you can only turn on the Manual Bypass Breaker (Q3) when the UPS needs maintenance. This ensures that the supply of power to the critical loads will continue. If you turn on the Manual Bypass Breaker (Q3) during normal mode, the inverter will shut down, the UPS will transfer from normal mode to manual bypass mode, and the output won't be protected.
2. In manual bypass mode, the manual bypass supplies power to the critical loads and maintenance personnel can perform maintenance without interrupting the power supply to the critical loads.
3. When the UPS is in manual bypass mode, there is no high voltage inside the UPS except the wiring terminal block, the Manual Bypass Breaker (Q3), the Battery Breaker (Q5) and the rack-mount PDC (optional; at maximum one). Do not touch the wiring terminal block, the Manual Bypass Breaker (Q3), the Battery Breaker (Q5) and the rack-mount PDC (optional; at maximum one) to avoid electrical shock.

- **From Normal Mode to Manual Bypass Mode (Parallel)**

- 1 Press the OFF button of one of the parallel UPSs for 3 seconds and release it after you hear a beep. The LCD shows the message: **"SHUTDOWN UPS?"**. Select **"YES"** and press the **←** key to confirm your selection. Either situation A or B might occur:

- A. If the remaining parallel UPSs' total capacity exceeds the total critical loads, the inverter of the UPS that you turned off will automatically shut down, and the critical loads will be shared equally by the remaining parallel UPSs.

The LCD status for the UPS that you turned off:

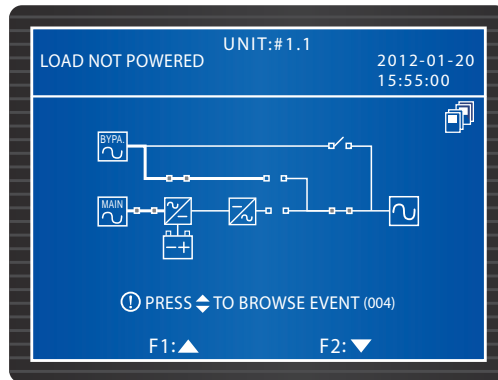

The LCD status for each of the remaining parallel UPSs:

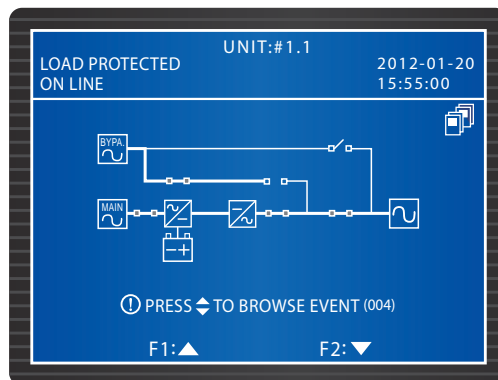

- B. If the total critical loads exceed the remaining parallel UPSs' total capacity, all of the parallel UPSs' inverters will shut down, and all parallel UPSs will transfer to Bypass Mode. The total critical loads will be shared equally by all parallel UPSs, and the status of LCD for each of the parallel UPSs is as follows.

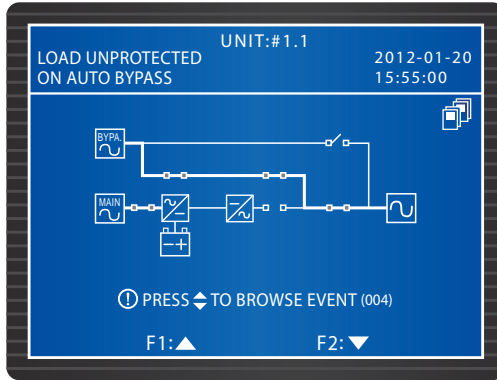

- 2) If the UPS that you turned off matches Situation A, repeat the procedures stated in 1) and turn off the Main Input Breaker (Q1) to continually switch the remaining parallel UPSs into bypass mode. If the UPS that you turned off matches Situation B, turn off each UPS's Main Input Breaker (Q1). After that, each UPS's LCD shows the following screen.

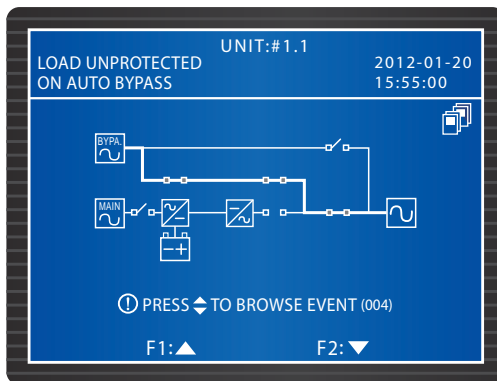

- 3) Each Power Module starts discharging and its LED indicator flashes. After discharging, each Power Module's LED indicator is off. After that, turn off each UPS's external battery cabinets' breakers or each UPS's Battery Breaker (Q5).

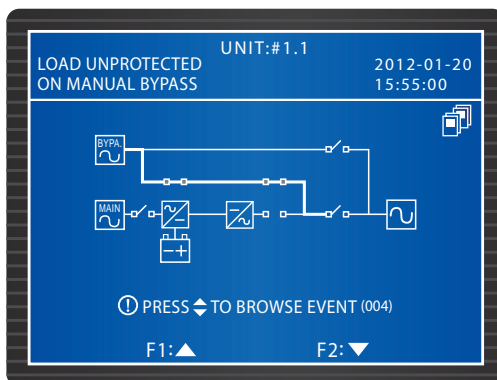

- 4 Turn ON each UPS's Manual Bypass Breaker (Q3). The manual bypass supplies power to the critical loads.
 - 5 Turn OFF each unit's Output Breaker (Q4) and Bypass Breaker (Q2). All LED indicators are off and each UPS's LCD shuts down.
- **From Manual Bypass Mode to Normal Mode (Parallel)**
 - 1 Switch ON each UPS's external battery cabinets' breakers or each UPS's Battery Breaker (Q5).
 - 2 Switch ON each unit's Output Breaker (Q4) and Bypass Breaker (Q2). Each STS Module's fans start running and each UPS's LCD shows the following screen.

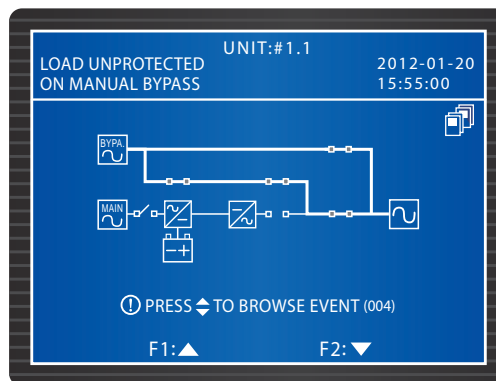

- 3 Turn OFF each unit's Manual Bypass Breaker (Q3). Per unit transfers into bypass mode and it is the bypass to supply power to the critical loads.

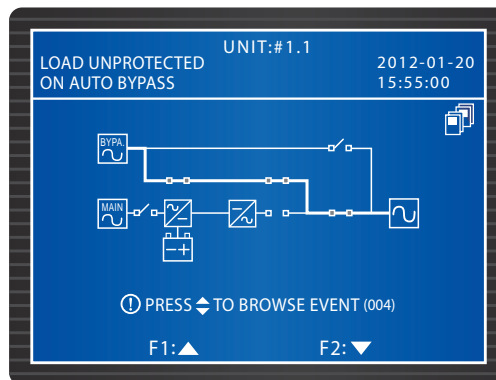

- 4 Switch ON each unit's Main Input Breaker (Q1). Each Power Module's fans start running and each UPS's LCD shows the following screen.

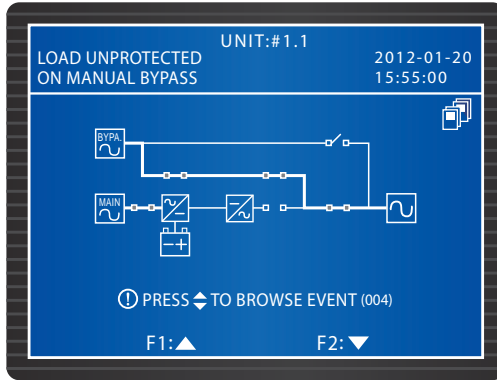

- 5) Press each UPS's ON button for 3~10 seconds and release it after you hear a beep. The following screen appears on each unit's LCD.

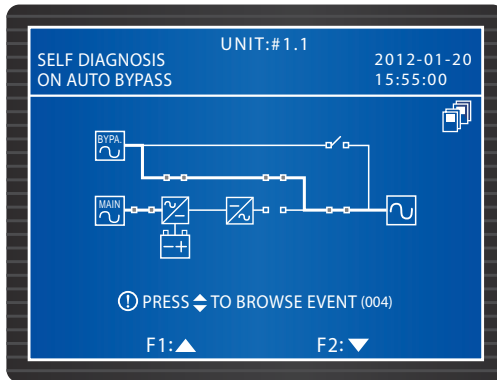

- 6) After each UPS's inverter voltage establishes, all parallel UPSs will transfer into normal mode. At this moment, each UPS's BYPASS LED turns off and NORMAL LED lights up. Each UPS's LCD shows the following screen.

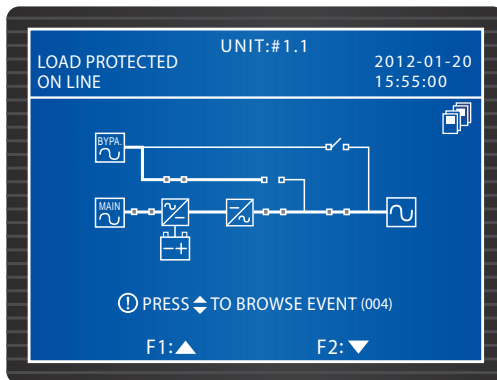

6.3.5 Normal Mode Turn-off Procedures (Parallel)



NOTE:

If you wish to turn off one of the paralleled UPSs and the UPS has the rack-mount PDC (optional; at maximum one) installed, please depend on the actual requirements to decide whether the breakers of the hot-swappable breaker modules installed in the UPS's rack-mount PDC need to be turned off or not. After that, follow the UPS turn-off procedures below. All symbols relevant to the rack-mount PDC will show at the upper left corner of the LCD; please refer to **6.1 Pre-operation Warnings**.

Press the OFF button of one of the parallel UPSs for 3 seconds and release it after you hear a beep. The LCD shows the message: “**SHUTDOWN UPS?**”. Select “**YES**” and press the **←** key to confirm your selection. Either situation A or B might occur:

- A. If the remaining parallel UPSs' total capacity exceeds the total critical loads, the inverter of the UPS that you turned off will automatically shut down, and the critical loads will be shared equally by the remaining parallel UPSs.

The LCD status for the UPS that you turned off:

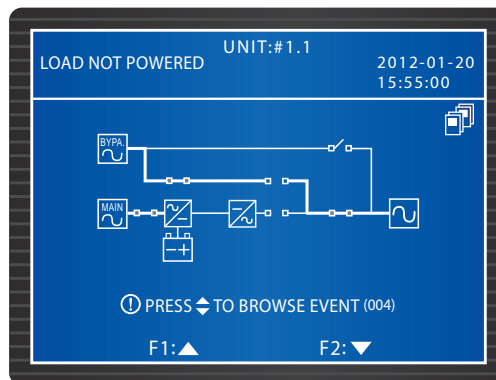

The LCD status for each of the remaining parallel UPSs:

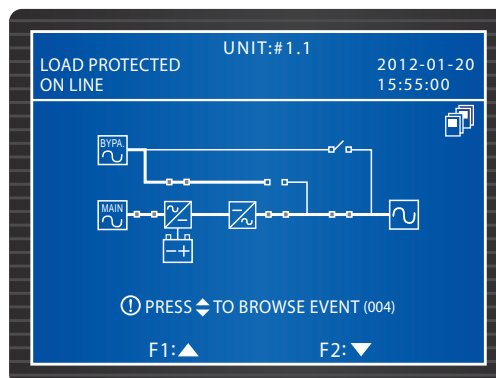

- 1 Turn off the Main Input Breaker (Q1) and the Output Breaker (Q4) of the UPS that you just turned off. The UPS's LCD shows the following screen.

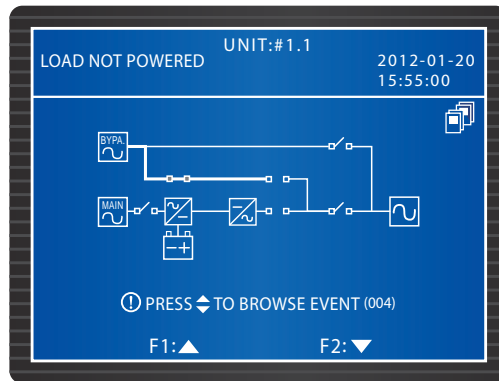

- 2 Wait until the UPS's Power Modules finish discharging. During the discharging process, each Power Module's LED indicator flashes. After discharging, each Power Module shuts down and its LED indicator shuts off.
- 3 Turn off the UPS's Bypass Breaker (Q2). After that, switch off the UPS's external battery cabinets' breakers or the UPS's Battery Breaker (Q5). All LEDs are off and no screen appears.



NOTE: If you need to turn off the remaining parallel UPSs, please repeat the procedures above.

- B. If the total critical loads exceed the remaining parallel UPSs' total capacity, all of the parallel UPSs' inverters will shut down, and all parallel UPSs will transfer to Bypass Mode. The total critical loads will be shared equally by all parallel UPSs, and the status of LCD for each of the parallel UPSs is as follows.

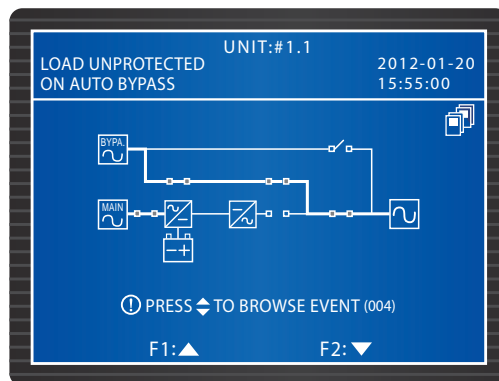

- ① Since all parallel UPSs are in bypass mode, the critical loads won't be protected if a power failure occurs. Please confirm whether the critical loads should be shut down or not.
- ② Wait until all parallel UPSs' Power Modules finish discharging. During the discharging process, each Power Module's LED indicator flashes. After discharging, each Power Module shuts down and its LED indicator shuts off.

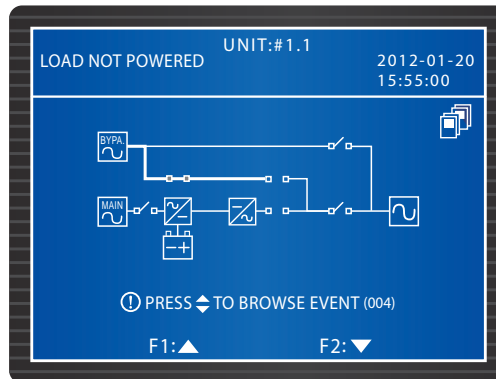

- ③ Switch off each UPS's Bypass Breaker (Q2). After that, turn off each UPS's external battery cabinets' breakers or each UPS's Battery Breaker (Q5). All LEDs are off and no screen appears.

6.3.6 Battery Mode Turn-off Procedures (Parallel)



NOTE:

If you wish to turn off one of the paralleled UPSs and the UPS has the rack-mount PDC (optional; at maximum one) installed, please depend on the actual requirements to decide whether the breakers of the hot-swappable breaker modules installed in the UPS's rack-mount PDC need to be turned off or not. After that, follow the UPS turn-off procedures below. All symbols relevant to the rack-mount PDC will show at the upper left corner of the LCD; please refer to **6.1 Pre-operation Warnings**.

Press the OFF button of one of the parallel UPSs for 3 seconds and release it after you hear a beep. The LCD shows the message: "**SHUTDOWN UPS?**". Select "**YES**" and press the **←** key to confirm your selection. Either situation A or B might occur:

- A. If the remaining parallel UPSs' total capacity exceeds the total critical loads, the inverter of the UPS that you turned off will automatically shut down, and the critical loads will be shared equally by the remaining parallel UPSs.

The LCD status for the UPS that you turned off:

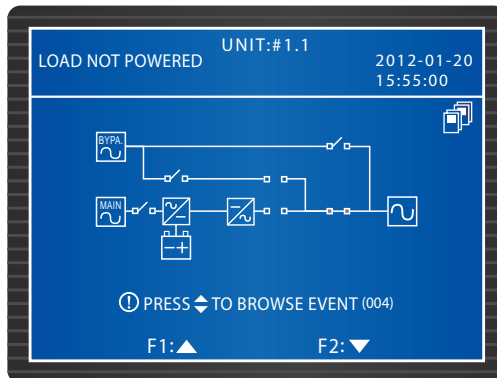

The LCD status for each of the remaining parallel UPSs:

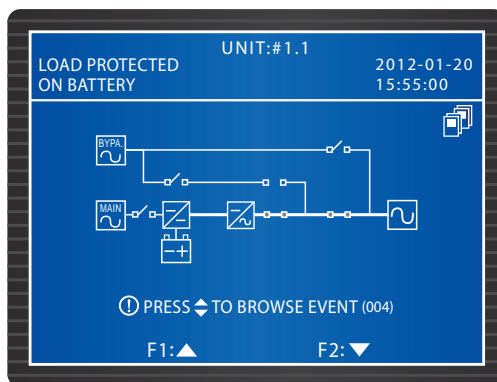

- 1 Switch OFF the Output Breaker (Q4) of the UPS that you turned off. The following screen appears.

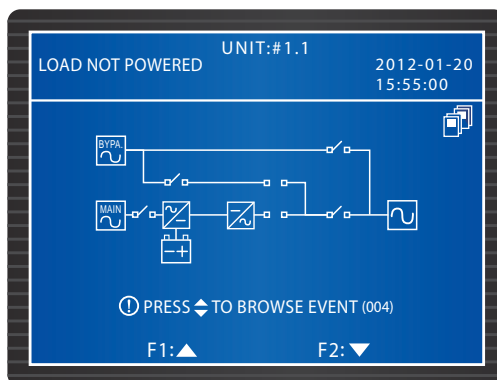

- ② Wait until the UPS's Power Modules finish discharging. During the discharging process, each Power Module's LED indicator flashes. After discharging, each Power Module shuts down and its LED indicator shuts off. After that, all LEDs are off and no screen appears.



NOTE: If you need to turn off the remaining parallel UPSs, please repeat the procedures above.

- B. If the total critical loads exceed the remaining parallel UPSs' total capacity, all parallel UPSs' inverters will shut down and all Power Modules will automatically turn off. At this moment, no power supplies to the critical loads.

- ① Turn OFF each unit's Output Breaker (Q4). The following screen appears on each UPS's LCD.

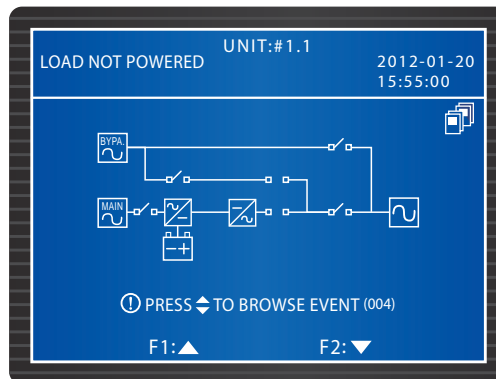

- ② Wait until all parallel UPSs' Power Modules finish discharging. During the discharging process, each Power Module's LED indicator flashes. After discharging, each Power Module shuts down, and all parallel UPSs' LEDs and LCDs shut off.

6.3.7 Bypass Mode Turn-off Procedures (Parallel)



NOTE:

If you wish to turn off one of the paralleled UPSs and the UPS has the rack-mount PDC (optional; at maximum one) installed, please depend on the actual requirements to decide whether the breakers of the hot-swappable breaker modules installed in the UPS's rack-mount PDC need to be turned off or not. After that, follow the UPS turn-off procedures below. All symbols relevant to the rack-mount PDC will show at the upper left corner of the LCD; please refer to **6.1 Pre-operation Warnings**.

- 1 During bypass mode, the status of the LCD for each of parallel UPSs is as follows.

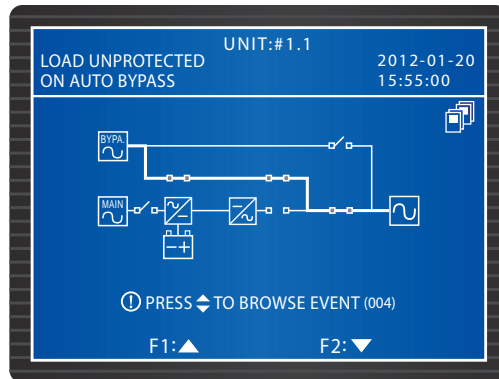

- 2 Turn OFF one of the parallel UPSs' Bypass Breaker (Q2) and Output Breaker (Q4). The UPS' LEDs and the LCD are off. If you need to turn off the remaining parallel UPSs, please repeat the procedures above.

6.3.8 Manual Bypass Mode Turn-off Procedure (Parallel)



NOTE:

If you wish to turn off one of the paralleled UPSs and the UPS has the rack-mount PDC (optional; at maximum one) installed, please depend on the actual requirements to decide whether the breakers of the hot-swappable breaker modules installed in the UPS's rack-mount PDC need to be turned off or not. After that, follow the UPS turn-off procedures below. All symbols relevant to the rack-mount PDC will show at the upper left corner of the LCD; please refer to **6.1 Pre-operation Warnings**.

During manual bypass mode, no LED illuminates and no screen appears. Turn off each UPS's Manual Bypass Breaker (Q3) to shut down the parallel UPSs.

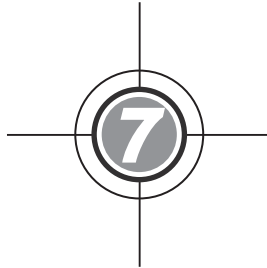

LCD Display & Settings

7.1 LCD Display Hierarchy

7.2 LCD Display & Function Keys

7.3 Password Entry

7.4 Main Screen

7.5 Main Menu

7.6 Check System Readings

7.7 UPS Configurations

7.8 System Maintenance

7.9 Power Distribution

7.1 LCD Display Hierarchy

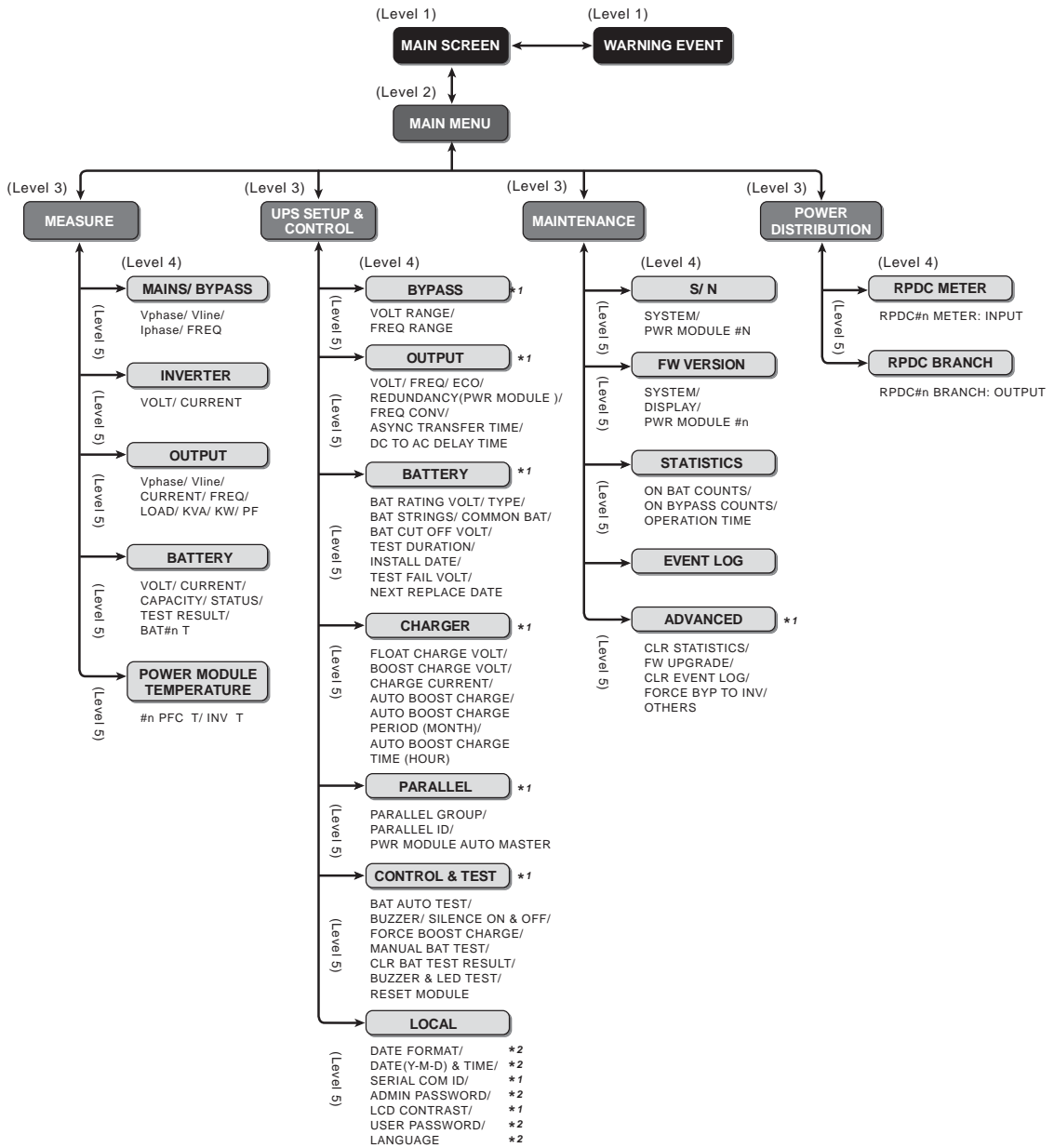

(Figure 7-1: LCD Display Hierarchy)



NOTE:

1. *1: ADMINISTRATOR password is required to change a setting. *2: USER pass-word is required to change a setting. Please refer to **7.3 Password Entry**.
2. All of the unit No., date, time, and event No. shown in this chapter are for reference only. Actual readings depend on the operation of the UPS.

7.2 LCD Display & Function Keys

The LCD display supports multiple languages (default: English). To change the default language, please refer to **7.8.4 Change Display Language**.

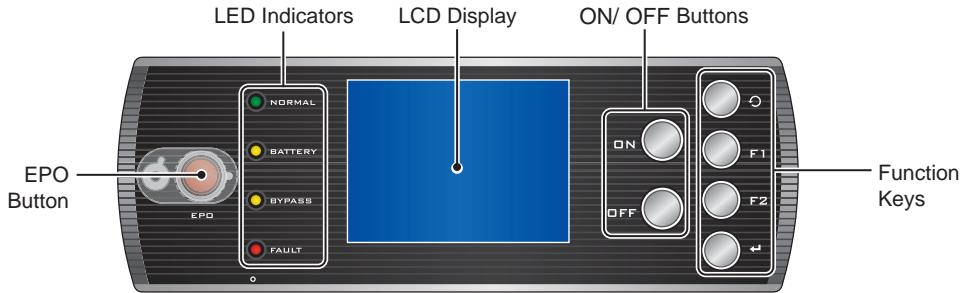

(Figure 7-2: Control Panel)

Please refer to the table below for button functions:





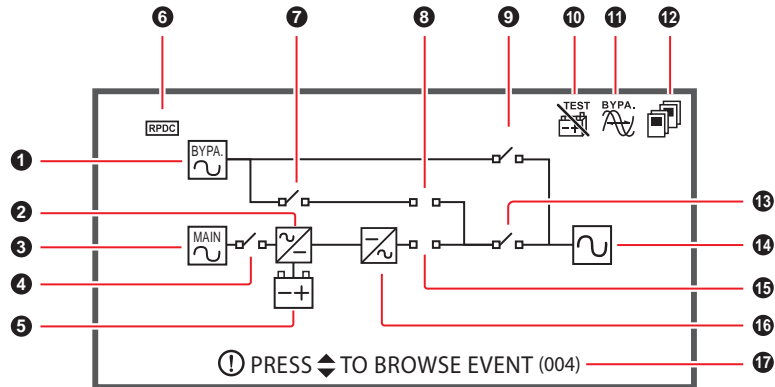





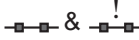
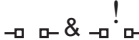







No.	Symbol	Button	Function														
1	ON	ON button	Press the ON button for 3~10 seconds and release it after you hear a beep. The UPS starts up and supply the power to the critical loads.														
2	OFF	OFF button	Press the OFF button for 3 seconds and release it after you hear a beep. Confirm to shut down the UPS.														
3	↻	Return/ Cancel key	Goes back to previous screen or cancels current selection.														
4	←	Enter key	Enters a selected menu, item or confirms current selection.														
5	F1 F2	Function key F1 Function key F2	Depend on the symbols shown on the LCD: <table border="1" style="margin-left: 20px;"> <thead> <tr> <th>Symbol</th> <th>Function</th> </tr> </thead> <tbody> <tr> <td>▲</td> <td>Moves up/ goes back to previous page.</td> </tr> <tr> <td>▼</td> <td>Moves down/ goes to next page.</td> </tr> <tr> <td>◀</td> <td>Moves left.</td> </tr> <tr> <td>▶</td> <td>Moves right.</td> </tr> <tr> <td>+</td> <td>Increases number.</td> </tr> <tr> <td>-</td> <td>Decreases number.</td> </tr> </tbody> </table>	Symbol	Function	▲	Moves up/ goes back to previous page.	▼	Moves down/ goes to next page.	◀	Moves left.	▶	Moves right.	+	Increases number.	-	Decreases number.
Symbol	Function																
▲	Moves up/ goes back to previous page.																
▼	Moves down/ goes to next page.																
◀	Moves left.																
▶	Moves right.																
+	Increases number.																
-	Decreases number.																

Please see below for the meaning of other symbols shown on the LCD:



(Figure 7-3: Symbols on the LCD)

No.	Symbol	Meaning
1		Bypass source
2		AC to DC conversion
		DC to DC conversion
3		Main AC power
4		Main Input Breaker is in the ON position.
		Main Input Breaker is in the OFF position.
5		Battery normal
		Battery low
6		The UPS successfully communicates with the rack-mount PDC (optional; at maximum one).
		There is abnormal communication between the UPS and the rack-mount PDC (optional; at maximum one).
	No symbol	The UPS has never communicated with the rack-mount PDC (optional; at maximum one).
7		Bypass Breaker is in the ON position.
		Bypass Breaker is in the OFF position.
8		On Bypass & the STS module's latch is closed.

No.	Symbol	Meaning
8		Not on Bypass & the STS module's latch is closed.
	 flash alternately	On Bypass & the STS module's latch is opened.
	 flash alternately	Not on Bypass & the STS module's latch is opened.
9		Manual Bypass Breaker is in the ON position.
		Manual Bypass Breaker is in the OFF position.
10		Battery test cannot be executed.
	No symbol	Battery test can be executed.
11		Bypass frequency unstable.
	No symbol	Bypass frequency stable.
12	No symbol	Single unit
	 flashes	Parallel cable is abnormal.
	 flash alternately	Parallel cable is well connected.
13		Output Breaker is in the ON position.
		Output Breaker is in the OFF position.
14		Output
15		On Inverter (Static Switch is in the ON position).
		Not on Inverter (Static Switch is in the OFF position).
16		DC to AC conversion
17		There is a warning event.
	No symbol	No warning event.
Others		Cursor
		When the symbol  changes to the symbol  , it means that you can change your selected item's setting.

7.3 Password Entry

There are two levels of password protection:

- **ADMINISTRATOR** password allows qualified installation and maintenance personnel to view and change all settings.
- **USER** password only allows general users to set up (1) DATE & TIME, (2) DATE FORMAT, (3) LCD CONTRAST, (4) USER PASSWORD and (5) LANGUAGE.

The default setting for **USER** password is 0000. For **ADMINISTRATOR** password, please contact service personnel. When you try to change a setting, the following screen prompts you to enter a corresponding password.

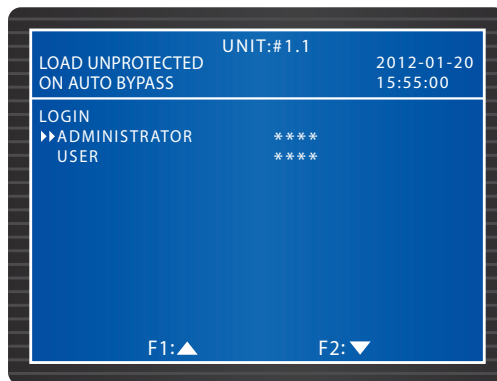

If an interval between settings is over five minutes, you have to login and enter the password again. If the password is wrong, the system will go back to the screen that you have selected the item for setup change.

7.4 Main Screen

In the Main Screen, if the message **PRESS TO BROWSE EVENT (004)** appears, it indicates a warning event has occurred. Press **F1** or **F2** to check the warning event. Press **↻** to return to the Main Screen. The digit in () is the event code. If you install the rack-mount PDC (optional, at maximum one) in the UPS and the warning event is related to the rack-mount PDC, the word 'PDC' will display in the (), ex. **PRESS TO BROWSE EVENT (PDC)** .

To clear the event logs, go to **MAIN MENU** → **MAINTENANCE** → **ADVANCED** → **CLEAR EVENT LOG**. The ADMINISTRATOR password is required.

The backlight automatically turns off after 5 minutes of inactivity. Press any key to awaken the LCD.

The main screen shows the operation status of the UPS:

1. No power is supplied to the critical loads.

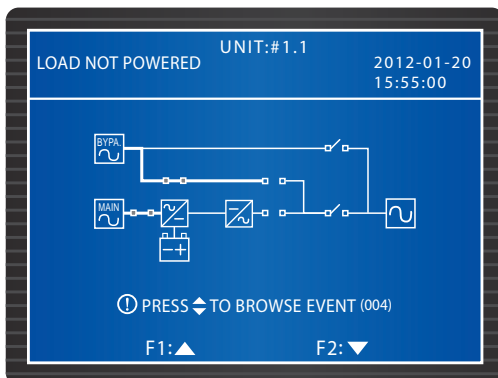

2. The bypass is supplying power to the critical loads.

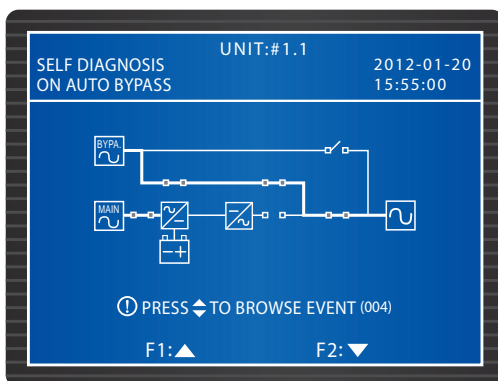

3. The batteries have started up the UPS.

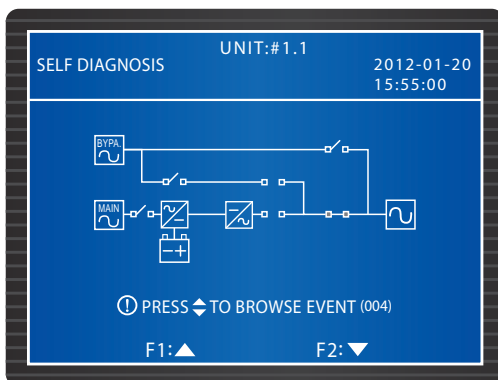

- The UPS is in Bypass Mode. The main AC source and the batteries are off. If the bypass AC source fails, the critical loads won't be protected.

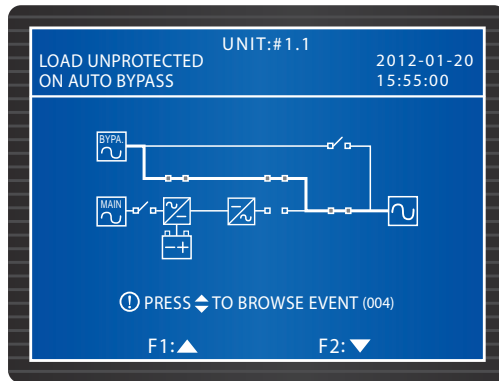

- The UPS is in Normal Mode.

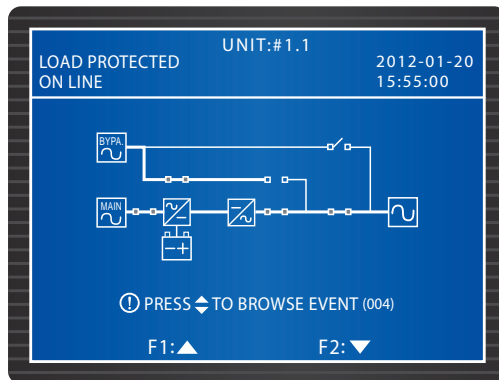

- The UPS is in Battery Mode. The batteries supply power to the critical loads.

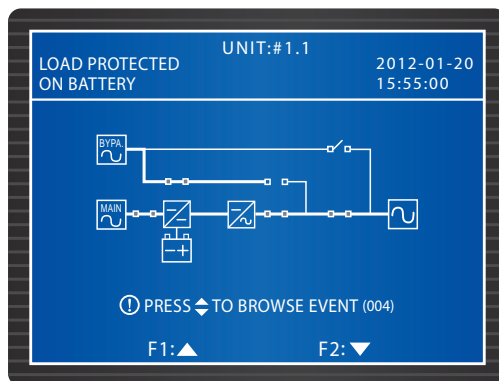

7. The UPS is executing a battery test.

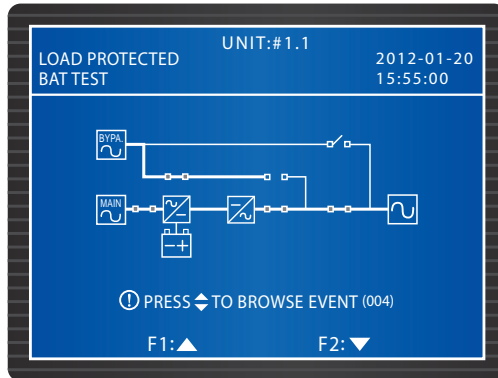

8. The UPS is in ECO Mode and the bypass supplies power to the critical loads. For more information about the ECO Mode, please refer to **7.7.2 Output Setup**.

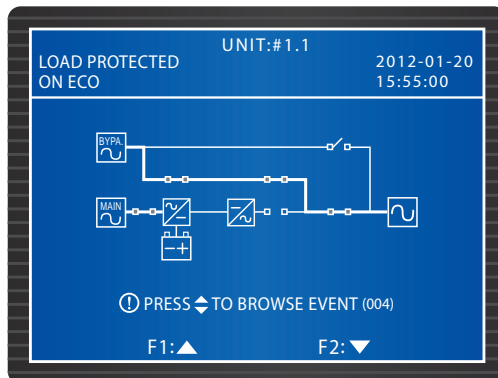

NOTE:

To ensure power supply quality, it is recommended that you set up the UPS in ECO mode only when the line power is stable. Only maintenance personnel can set up ECO mode.

9. The UPS is in Manual Bypass Mode. Before maintenance, do not forget to switch the UPS into Manual Bypass Mode and cut off the main AC source and batteries. During this mode, if the bypass AC source fails, the critical loads won't be protected.

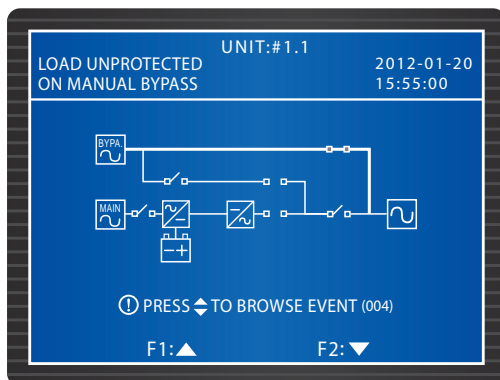

7.5 Main Menu

In the Main Screen, press **←** to enter into the Main Menu shown below. Please refer to the following chapters for details:

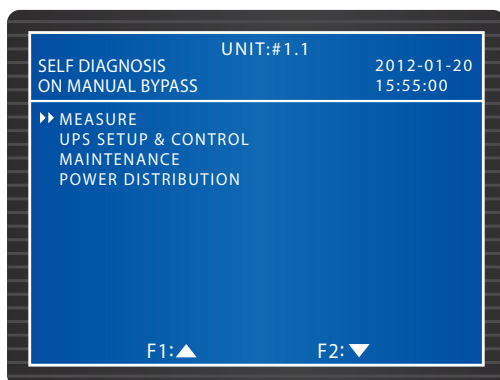

7.6 Check System Readings

Path : MAIN MENU → MEASURE

The screens below show the UPS's readings. Press **F 1** or **F 2** to navigate between screens, including **MAINS/ BYPASS**, **OUTPUT**, **PWR MODULE TEMPERATURE**, **INVERTER** and **BATTERY**.

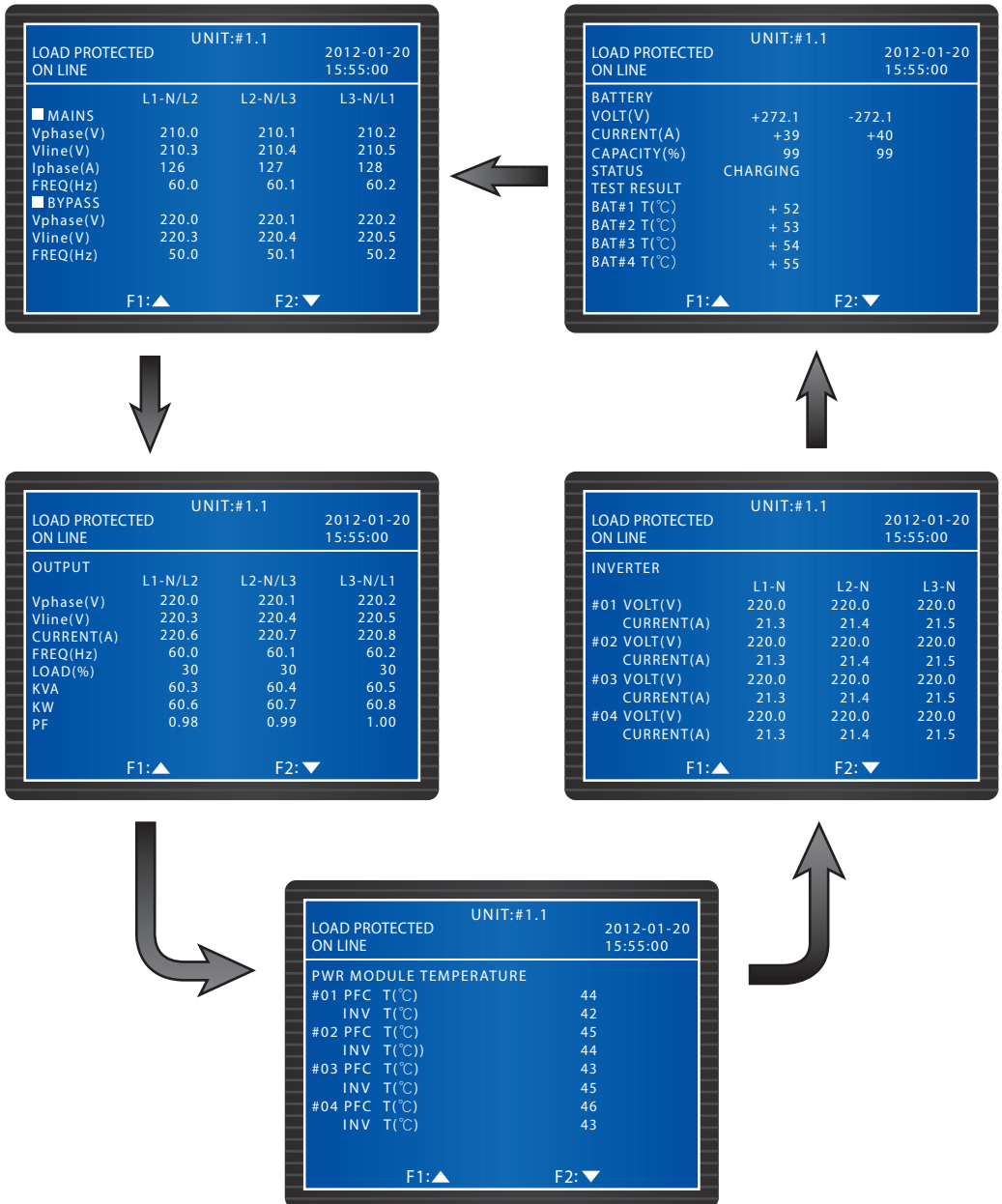

7.7 UPS Configurations

7.7.1 Bypass Setup

Path : MAIN MENU → UPS SETUP & CONTROL → BYPASS SETUP

Set up the **VOLT RANGE** and **FREQ RANGE** for the Bypass Mode. The UPS will disable the bypass function when the actual readings are out of the set-up range.

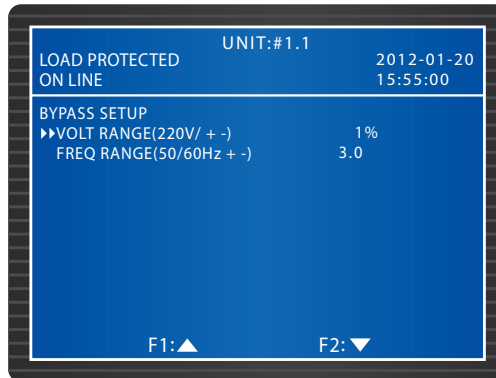

7.7.2 Output Setup

Path : MAIN MENU → UPS SETUP & CONTROL → OUTPUT SETUP

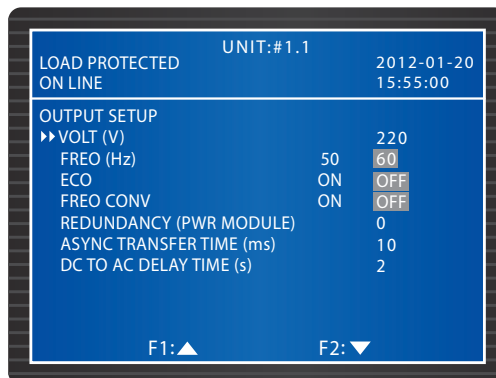

Check output related settings from this screen. Set up the output voltage (**VOLT**) and frequency (**FREQ**). If **ECO** Mode is activated, i.e. when the bypass voltage is within $\pm 10\%$ of the rating voltage and the bypass frequency is within ± 5 Hz of the rating frequency, the UPS will run in Bypass Mode; otherwise, the UPS will run in Normal Mode.

When **FREQ CONV** (Frequency Conversion) is OFF, the UPS detects and synchronizes with the bypass frequency as it starts up the inverter. If it is ON (default), the UPS will run in a frequency set in **FREQ**.

Use **REDUNDANCY** this item to set up how many Power Modules that you want to reserve for system redundancy.

ASYNC TRANSFER TIME means the power-off duration time when the UPS transfers from Normal Mode to Bypass Mode. It helps to protect the inverter during the transfer process.

When the AC power is abnormal, the UPS will transfer from Normal Mode (AC power) to Battery Mode (DC power) to keep supplying power to the critical loads. **The DC TO AC DELAY TIME** means the time that the UPS needs to switch back to AC power after the recovery of AC source.

7.7.3 Battery Setup

Path : MAIN MENU → UPS SETUP & CONTROL → BATTERY SETUP

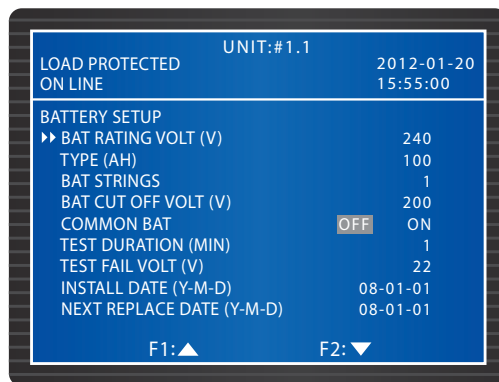

If an external battery cabinet is connected to the UPS, please set up the items shown in the screen above.

In Battery Mode, when the battery voltage is below the value set in the **BAT CUT OFF VOLT**, the battery power will cut off and the critical loads won't be protected.

To share external battery cabinets between parallel UPSs, please set **COMMON BAT ON**.

Set up the **TEST DURATION** for the battery test. During the test, if the voltage is below the **TEST FAIL VOLT** value, it means battery fail.

Record the **INSTALL DATE** to keep a track of the battery installation time. A warning event will occur when the **NEXT REPLACE DATE** is due.

If the UPS use the optional battery module (at maximum four), please set **TYPE (AH)** as **9** all the time, and follow how many battery modules that you install in the UPS to set **BAT STRINGS** (at maximum four). For information about the battery module, please refer to **5.7 Battery Module**.

7.7.4 Charger Setup

Path : MAIN MENU → UPS SETUP & CONTROL → CHARGER SETUP

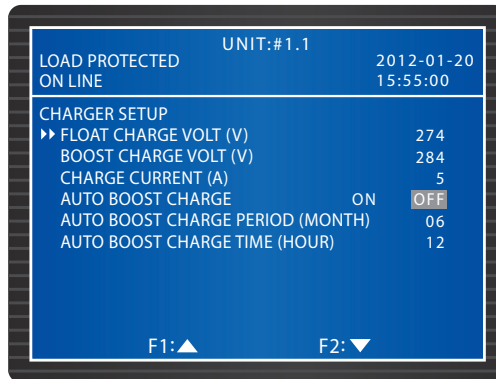

In this screen, you can set up **FLOAT CHARGE VOLT (V)**, **BOOST CHARGE VOLT (V)**, **CHARGE CURRENT (A)**, **AUTO BOOST CHARGE**, **AUTO BOOST CHARGE PERIOD (MONTH)** and **AUTO BOOST CHARGE TIME (HOUR)**.

7.7.5 Parallel Setup

Path : MAIN MENU → UPS SETUP & CONTROL → PARALLEL SETUP

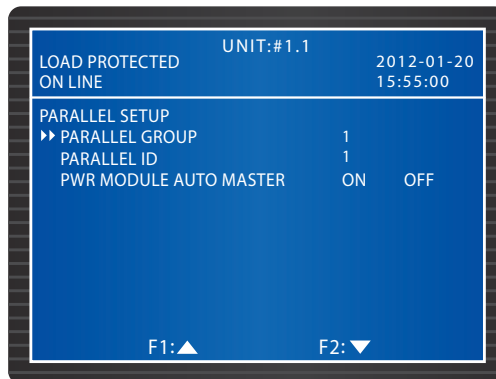

If you parallel UPSs, please set up **PARALLEL GROUP** and **PARALLEL ID**.

If all parallel UPSs connect to the same group of critical loads, set each parallel UPS's **PARALLEL GROUP** as **1**. If parallel UPSs connect to different groups of critical loads (maximum group: two), set each UPS's **PARALLEL GROUP** as **1** or **2** accordingly. Set up a **PARALLEL ID** for each parallel UPS.

If you want the Power Modules to work in normal mode after the control module is removed, please select **ON**. If you want the Power Modules to work in bypass mode after the control module is removed, please select **OFF**.

7.7.6 Control & Test Setup

Path : MAIN MENU → UPS SETUP & CONTROL → CONTROL & TEST

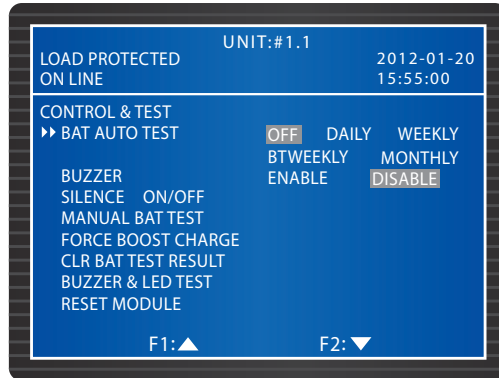

Set up a **BAT AUTO TEST** frequency or execute a **MANUAL BAT TEST**. The test result will show in **MAIN MENU** → **MEASURE** → **BATTERY**. You can clear the battery test result (**CLR BAT TEST RESULT**). Select **FORCE BOOST CHARGE** to manually charge the batteries.

If the **BUZZER** is set OFF, a new warning event will be recorded and the buzzer will remain mute. If **SILENCE** is set ON, the buzzer will be temporarily mute, but will go off automatically when a new warning event occurs.

If you execute a **BUZZER & LED TEST**, the four LED indicators on the control panel will light up and the buzzer will go off.



NOTE:

After entering each of the following selections, **SILENCE ON/OFF**, **MANUAL BAT TEST**, **FORCE BOOST CHARGE**, **CLR BAT TEST RESULT**, **BUZZER & LED TEST** and **RESET MODULE**, use the function key **F 1** or **F 2** to select **YES** or **NO**, and then press the **←** key to complete setup.

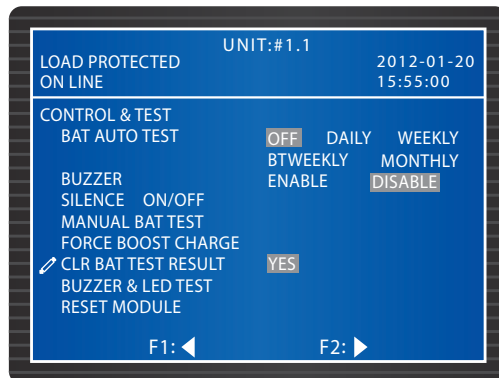

7.7.7 Local Setup

Path : MAIN MENU → UPS SETUP & CONTROL → LOCAL

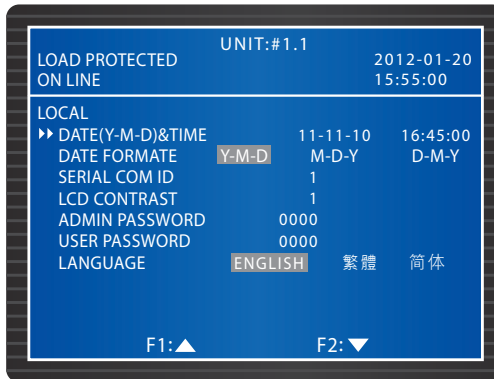

Set up the local settings in this screen. If UPSs are paralleled, set up **Serial COM ID** for each unit.

Change the **ADMINISTRATOR PASSWORD** or **USER PASSWORD** in this screen. Please note that, for safety concerns, the screen will always show 0000 for the **ADMINISTRATOR PASSWORD** and the **USER PASSWORD**.

7.8 System Maintenance

7.8.1 Check/ Clear Event Log

Path : MAIN MENU → MAINTENANCE → EVENT LOG

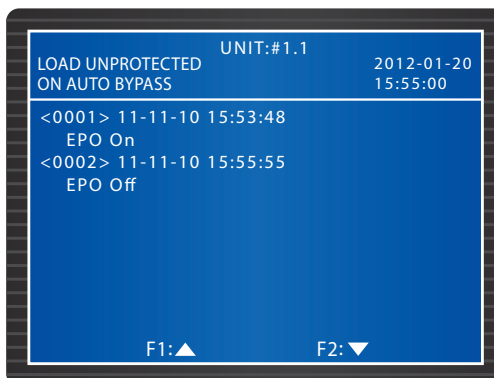

To check event logs, use the function key **F 1** and **F 2** to navigate between entries. Each entry will show the time, date and description.

To clear the event logs, go to **MAIN MENU** → **MAINTENANCE** → **ADVANCED** → **CLEAR EVENT LOG**. Use the function key **F1** or **F2** to select **YES** or **NO**, and then press the **←** key, all events in the log will be cleared. The **ADMINISTRATOR** password is required.

7.8.2 Check/ Clear Statistics

Path : **MAIN MENU** → **MAINTENANCE** → **STATISTICS**

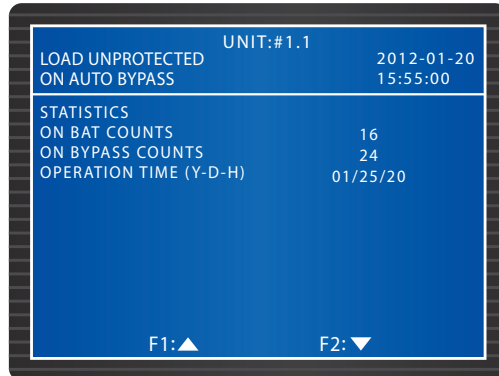

In this screen, you can check the **ON BAT COUNTS**, **ON BYPASS COUNTS** and **OPERATION TIME**. To clear the counts, go to **MAIN MENU** → **MAINTENANCE** → **ADVANCED** → **CLEAR STATISTICS**. Use the function key **F1** or **F2** to select **YES** or **NO**, and then press the **←** key, all events in the log will be cleared. The **ADMINISTRATOR** password is required.

7.8.3 Check Serial Number and Firmware Version

Path : **MAIN MENU** → **MAINTENANCE** → **S/N**

Check the System and the Power Modules' serial numbers.

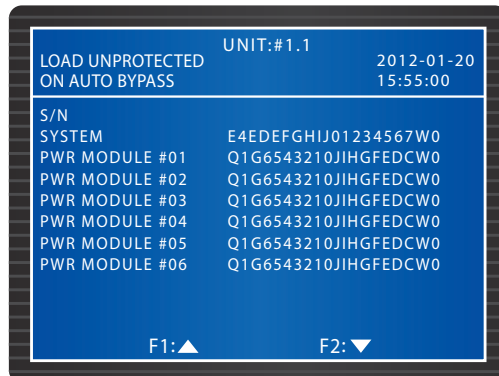

Path : MAIN MENU → MAINTENANCE → FW VERSION

Check **SYSTEM**, **DISPLAY** and **PWR MODULE** firmware versions. To upgrade a firmware, contact service personnel.

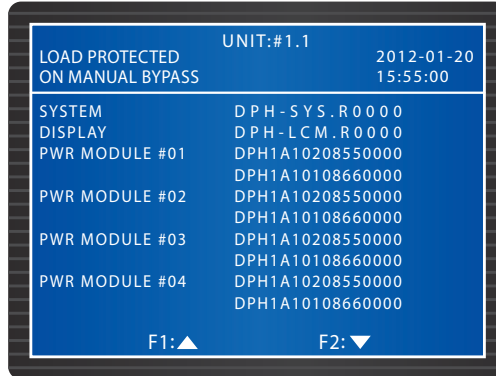

7.8.4 Change Display Language

Path : MAIN MENU → UPS SETUP & CONTROL → LOCAL → LANGUAGE

In this screen, set up the display **LANGUAGE**.

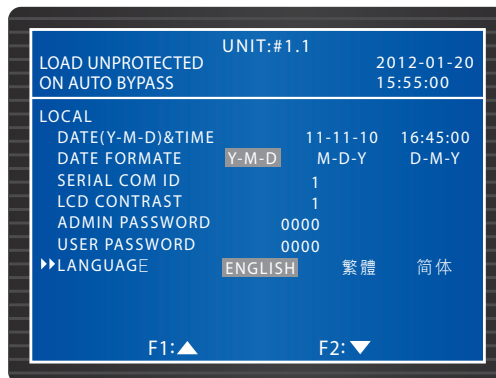

7.8.5 Reset Module

Path : MAIN MENU → UPS SETUP & CONTROL → CONTROL & TEST → RESET MODULE

If a Power Module is abnormal, select **RESET MODULE**. The system will automatically detect and reset the abnormal Power Module.

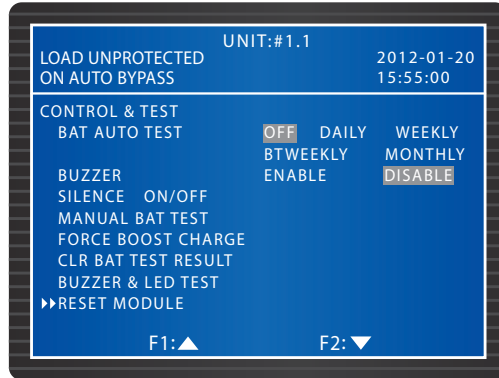

7.8.6 Reset LCD Display

Use the control panel's reset button shown below to reset the LCD display when the display is abnormal. Use a clip's tip to gently poke the button to reset the LCD display. This won't influence the saved settings and data.

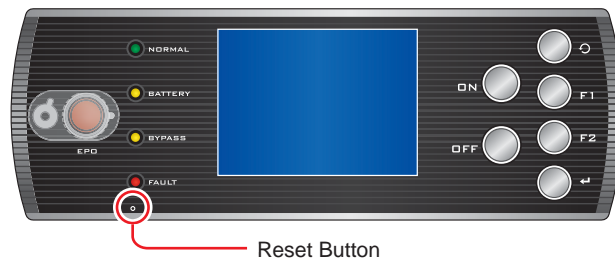

(Figure 8-2 : Reset LCD Display)

7.8.7 Force to Start Inverter

Path : MAIN MENU → MAINTENANCE → ADVANCED → FORCE BYP TO INV

In Bypass Mode, you can force to start the inverter to supply power to the critical loads. Use the function key **F 1** or **F 2** to select **YES** or **NO**, and then press the **←** key, the inverter will start up and the UPS will automatically transfer from Bypass Mode to Normal Mode. The **ADMINISTRATOR** password is required.

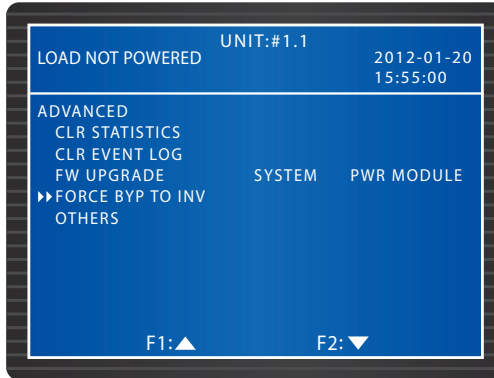

7.8.8 Check the STS Module and the Power Module Status

Path : MAIN MENU → MAINTENANCE → ADVANCED → OTHERS

Check the bypass static switch's status, and the Power Modules' Vbus readings, static switch status, charge voltage and charge current.

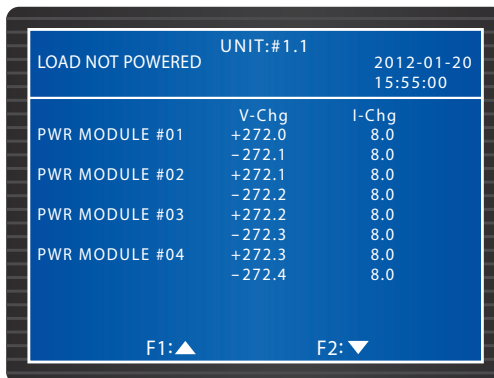
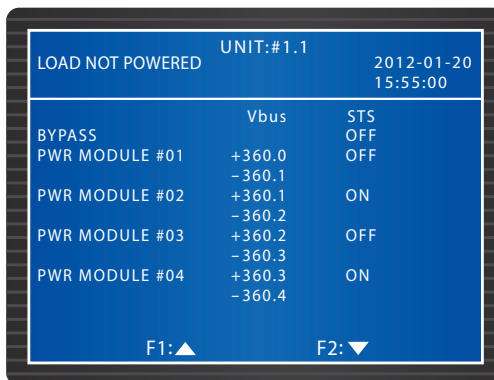

7.8.9 Upgrade Firmware

Path : MAIN MENU → MAINTENANCE → ADVANCED → FW UPGRADE

To upgrade a firmware upgrade, please contact service personnel.

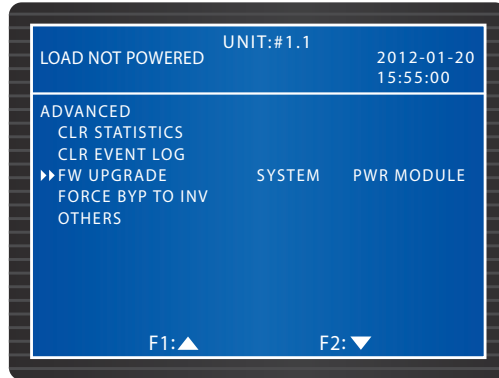

7.9 Power Distribution

7.9.1 RPDC METER

Path : MAIN MENU → POWER DISTRIBUTION → RPDC METER

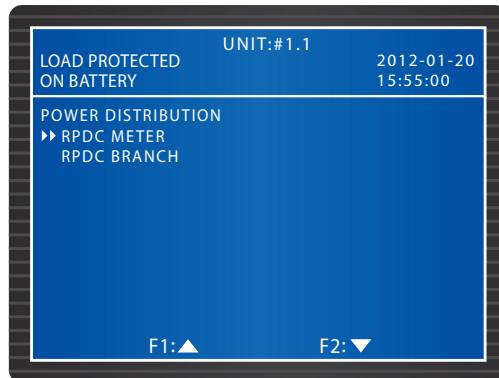

If you install the rack-mount PDC (optional, at maximum one) in the UPS, follow the route above to inquire about the rack-mount PDC's input data. Please refer to the figure below. If there is no input data, it will display "-".

UNIT:#1.1			
LOAD PROTECTED ON BATTERY			2012-01-20 15:55:00
RPDC#1 METER : INPUT			
	L1-N/L2	L2-N/L3	L3-N/L1
IPHASE(A)	35.0	32.8	36.9
LOAD(%)	28.6	30.2	28.1
I-NEUTRAL(A)	4.6		
TOTAL KVA	21.0		
TOTAL KW	22.7		
TOTAL KWh	342		
SYSTEM T(°C)	46.8		
F1:▲		F2:▼	

7.9.2 RPDC BRANCH

Path : MAIN MENU → POWER DISTRIBUTION → RPDC BRANCH

UNIT:#1.1			
LOAD PROTECTED ON BATTERY			2012-01-20 15:55:00
POWER DISTRIBUTION			
	RPDC METER		
	▶▶ RPDC BRANCH		
F1:▲		F2:▼	

If you install the rack-mount PDC (optional, at maximum one) in the UPS, follow the route above to inquire about the rack-mount PDC's output data. Each rack-mount PDC has 18 branches, and each screen displays 6 branches' output data. You can use the **F1** and **F2** keys to check all branches' output data back and forth. If there is no output data, it will display "-". Please refer to the figures below. For information about the 18 branches, please refer to the rack-mount PDC's user manual.

LOAD PROTECTED ON BATTERY		UNIT:#1.1		2012-01-20 15:55:00	
RPDC#1 BRANCH: OUTPUT					
	LOAD	/	CURRENT	/	KWh
	(%)		(A)		
#01	37.5	/	9.3	/	23
#02	34.5	/	8.8	/	36
#03	36.2	/	8.1	/	154
#04	37.5	/	9.3	/	235
#05	34.5	/	8.8	/	47
#06	36.2	/	8.1	/	102
F1:▲		F2:▼			

LOAD PROTECTED ON BATTERY		UNIT:#1.1		2012-01-20 15:55:00	
RPDC#1 BRANCH: OUTPUT					
	LOAD	/	CURRENT	/	KWh
	(%)		(A)		
#07	37.5	/	9.3	/	235
#08	37.5	/	8.8	/	36
#09	34.5	/	9.3	/	23
#10	36.2	/	8.8	/	154
#11	34.5	/	8.1	/	47
#12	36.2	/	8.1	/	102
F1:▲		F2:▼			

LOAD PROTECTED ON BATTERY		UNIT:#1.1		2012-01-20 15:55:00	
RPDC#1 BRANCH: OUTPUT					
	LOAD	/	CURRENT	/	KWh
	(%)		(A)		
#13	37.5	/	8.1	/	112
#14	34.5	/	9.3	/	32
#15	37.5	/	8.8	/	65
#16	36.2	/	8.1	/	47
#17	34.5	/	9.3	/	150
#18	36.2	/	8.8	/	225
F1:▲		F2:▼			

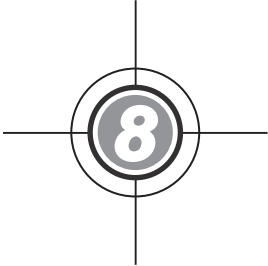

Optional Accessories

There are several optional accessories available for this DPH series UPS. Please refer to the table below for the optional accessories and their functions.

No.	Item	Function
1	SNMP Card (IPv4 or IPv6)	Monitors the UPS status via SNMP protocol.
2	Relay I/O Card	Provides additional dry contacts for other applications.
3	MODBUS Card	Provides MODBUS compatibility.
4	Battery Cabinet Temperature Sensor Cable	Detects an external battery cabinet's temperature.
5	Rack-mount PDC	Provides integrated power distribution system and monitoring functions (18-pole; 4U).
6	Hot-Swappable Breaker Module -16A (for Rack-mount PDC)	16A power distribution module (3-pole).
7	Hot-Swappable Breaker Module -32A (for Rack-mount PDC)	32A power distribution module (3-pole).
8	Dust Filter Kit	Prevents dust from entering into the UPS to ensure UPS reliability and to prolong product life.
9	Battery Module	Provides backup time when the main AC power fails. It is hot swappable. A battery module includes four battery boxes. For information about the battery module, please refer to 5.7 Battery Module .



REFERENCE:

1. For detailed installation and operation of any accessory mentioned above, please refer to the **Quick Guide, User Guide, or Installation & Operation Guide** included in the package of the relevant optional accessory.
2. If you want to buy any accessory mentioned above, please contact your local dealer or customer service.



Maintenance

- **UPS**

1. Cleaning:

Regularly clean the UPS, especially the slits and openings, to ensure that the air freely flows into the UPS to avoid overheating. If necessary, use an air blower to clean the slits and openings to prevent any object from blocking or covering the areas.

2. Regular inspection:

Regularly check the UPS every six months and inspect:

- 1) Whether the UPS, LED indicators, and buzzer are functioning normally.
- 2) Whether the UPS works in Bypass Mode (normally, the UPS should work in Normal Mode). If yes, check if any error, overload, internal fault, etc. occurs.
- 3) Whether battery voltage is normal. If the battery voltage is too high or too low, find the root cause.

- **Battery**

The UPS uses sealed lead-acid batteries. The battery life depends on the temperature, the usage, and the charging/ discharging frequency. High temperature environments and high charging/ discharging frequency will quickly shorten the battery life. Please follow the suggestions below to ensure a normal battery lifetime.

1. Keep usage temperature between 15°C ~ 25°C (59°F ~ 77°F).
2. When the UPS needs to be stored for an extended period of time, the batteries must be recharged once every three months and the charging time must not be less than 24 hours each time.
3. Monthly check the battery fuses locating at the rear of the UPS. Please refer to **2.6.4 Battery Fuses** for battery fuse location.

- **Fan**

Higher temperatures shorten fan life. When the UPS is running, please check if all fans work normally and make sure if the ventilation air can move freely around and through the UPS. If not, contact service personnel.



NOTE:

1. Please ask your local dealer or customer service for more maintenance information. Do not perform maintenance if you are not trained for it.
2. For maintenance information of the rack-mount PDC (optional; at maximum one), please refer to the rack-mount PDC's user manual.



Troubleshooting

When you see the following alarm messages appear on the LCD, please follow the solutions shown below.

No.	Alarm Message	Possible Cause	Solution
1	MAINS INPUT VOLT OR FREQ NOK	<ol style="list-style-type: none"> 1. The Main Input Breaker (Q1) is switched OFF. 2. The Main AC source's voltage or frequency is abnormal. 	<ol style="list-style-type: none"> 1. Check whether the Main Input Breaker (Q1) is switched OFF. If yes, turn it on. 2. If the Main Input Breaker (Q1) is turned on but the alarm still exists, contact service personnel. 3. Check if the main AC source's voltage or frequency is abnormal. If so, please wait until the main AC power recovers.
2	MAINS INPUT PHASE SEQ NOK	Wrong wiring.	Check if the main AC source's wiring and phase sequence are correct. If not, please contact service personnel.
3	PWR MODULE #n PFC FUSE OPEN SHUTDOWN	Power Module's PFC fuse is blown.	Contact service personnel.
4	PWR MODULE #n INV FUSE OPEN SHUTDOWN	Power Module's inverter fuse is blown.	Contact service personnel.
5	PWR MODULE #n GENERAL FAULT	Power Module's control circuit is abnormal, e.g. abnormal auxiliary power, failing soft start, etc.	Contact service personnel.
6	SYSTEM GENERAL FAULT	System's auxiliary power is abnormal.	Contact service personnel.
7	BAT GROUND FAULT	Incorrect battery wiring, or battery is leaking/damaged.	Check battery and battery wiring.
8	BAT CABINET OVER HEAT	<ol style="list-style-type: none"> 1. Battery temperature is too high. 2. Battery (batteries) has (have) abnormalities. 	<ol style="list-style-type: none"> 1. Decrease the battery temperature. 2. Check if battery (batteries) has (have) abnormalities. If yes, contact service personnel to replace the battery (batteries).
9	BAT TEST FAIL	<ol style="list-style-type: none"> 1. Wrong battery wiring. 2. Battery abnormality. 	<ol style="list-style-type: none"> 1. Check if battery grounding is correct. If not, contact service personnel. 2. Check if battery has abnormalities. If yes, contact service personnel to replace battery.
10	BAT LOW WARNING	Battery voltage is lower than warning limit.	If there is no backup power, immediately shut down the critical loads connected to the UPS.

No.	Alarm Message	Possible Cause	Solution
11	LOW BAT CUT OFF	Battery voltage is lower than shutdown limit.	If there is no backup power, the UPS will automatically discontinue power supply to the critical loads to protect battery until battery power recovers.
12	BAT REPLACE REQUIRED	<ol style="list-style-type: none"> 1. System date is wrongly set. 2. Battery replacement date is due. 	<ol style="list-style-type: none"> 1. Check if system date is set correctly. If not, correct it. 2. Check if battery replacement date is due. If yes, contact service personnel for replacement.
13	PWR MODULE #n CHARGER FAIL	Charger temperature is too high.	Contact service personnel.
14	BAT OVER CHARGE	Charger is abnormal.	Contact service personnel.
15	BAT MISSING	<ol style="list-style-type: none"> 1. Wrong battery wiring. 2. Insufficient battery voltage. 	<ol style="list-style-type: none"> 1. Check if battery wiring is correct. If not, contact service personnel. 2. Check if battery voltage is abnormal. If yes, contact service personnel.
16	FAN FAIL	<ol style="list-style-type: none"> 1. STS Module's fans have abnormalities. 2. Foreign matter is stuck in the STS Module's fans. 	Contact service personnel.
17	PWR MODULE #n PFC OVER HEAT WARNING	<ol style="list-style-type: none"> 1. Fans have abnormalities. 2. Foreign matter is stuck in the fans. 	Check if fans work abnormally or foreign matter is blocking a fan. If yes, contact service personnel. If not, please decrease some critical loads.
18	PWR MODULE #n PFC OVER HEAT SHUTDOWN	<ol style="list-style-type: none"> 1. Fans have abnormalities. 2. Foreign matter is stuck in the fans. 	Check if fans work abnormally or foreign matter is blocking a fan. If yes, contact service personnel. If not, please decrease some critical loads.
19	PWR MODULE #n INV OVER HEAT WARNING	<ol style="list-style-type: none"> 1. Fans have abnormalities. 2. Foreign matter is stuck in the fans. 	Check if fans work abnormally or foreign matter is blocking a fan. If yes, contact service personnel. If not, please decrease some critical loads.
20	PWR MODULE #n INV OVER HEAT SHUTDOWN	<ol style="list-style-type: none"> 1. Fans have abnormalities. 2. Foreign matter is stuck in the fans. 	Check if fans work abnormally or foreign matter is blocking a fan. If yes, contact service personnel. If not, please decrease some critical loads.
21	PFC SCR FAULT	<ol style="list-style-type: none"> 1. PFC SCR is damaged. 2. Driving circuit is damaged. 	Contact service personnel.

No.	Alarm Message	Possible Cause	Solution
22	PWR MODULE #n DC BUS NOK	DC BUS voltage is too high or too low.	Contact service personnel.
23	PWR MODULE #n INV OUTPUT NOK	Inverter's output voltage is too high or too low.	Contact service personnel.
24	UPS OUTPUT FAULT SHUTDOWN	Inverter's output voltage is too high or too low.	Contact service personnel.
25	INV OVER CURRENT	Output might have shorting issues.	Contact service personnel.
26	PWR MODULE #nn INV SHORT SHUTDOWN	Output might have shorting issues.	Contact service personnel.
27	PWR MODULE #n INV STS FAIL SHUTDOWN	<ol style="list-style-type: none"> 1. Inverter's static switch is damaged. 2. Inverter's driving circuit is damaged. 	Contact service personnel.
28	BYPASS STS OVER HEAT	<ol style="list-style-type: none"> 1. Fans have abnormalities. 2. Foreign matter is stuck in the fans. 3. UPS is overloaded. 	Check if fans work abnormally or foreign matter is blocking a fan. If yes, contact service personnel. If not, please decrease some critical loads.
29	BYPASS INPUT VOLT OR FREQ NOK	<ol style="list-style-type: none"> 1. The Bypass Breaker (Q2) is switched OFF. 2. Bypass voltage or frequency is abnormal. 	<ol style="list-style-type: none"> 1. Check if the Bypass Breaker (Q2) is switched off. If yes, turn it on. 2. If the Bypass Breaker (Q2) is turned on but the alarm still exists, contact service personnel. 3. Check if bypass voltage or frequency is abnormal. If yes, please wait until bypass AC source recovers.
30	BYPASS INPUT PHASE SEQ NOK	Incorrect wiring.	Check if the bypass AC source's wiring and phase sequence are correct. If not, contact service personnel for assistance.
31	BYPASS STS OVER CURRENT	The UPS is overloaded.	Decrease some critical loads.
32	BYPASS STS FAIL	<ol style="list-style-type: none"> 1. Bypass static switch is damaged. 2. Bypass driving circuit is damaged. 	Contact service personnel.

No.	Alarm Message	Possible Cause	Solution
33	EMERGENCY POWER OFF	EPO is activated.	Shut down the UPS. After emergency events are eliminated, follow turn-on procedures to start up the UPS.
34	PWR MODULE #n COMMUNICATION NOK	<ol style="list-style-type: none"> 1. Internal communication cable is not firmly connected. 2. Communication circuit is abnormal. 	Contact service personnel.
35	EXT PARALLEL COMMUNICATION NOK	Parallel cable is not firmly connected.	Check if parallel cable is firmly connected or not. If not, connect it firmly.
36	PARALLEL FAIL	<ol style="list-style-type: none"> 1. There are conflicts between parallel UPSs' IDs. 2. Parallel UPSs are not compatible. 3. Power Modules are not compatible. 	<ol style="list-style-type: none"> 1. Check if there are conflicts between parallel UPSs' IDs. If yes, contact service personnel. 2. Check if parallel UPSs are compatible or not. If not, contact service personnel. 3. Check if Power Modules are compatible or not. If not, contact service personnel.
37	ON MANUAL BYPASS	The Manual Bypass Breaker (Q3) is switched ON.	<ol style="list-style-type: none"> 1. Check if the Manual Bypass Breaker (Q3) is turned ON. If yes, turn it OFF. 2. If the Manual Bypass Breaker (Q3) is turned OFF and the alarm still exists, contact service personnel.
38	REDUNDANCY LOSS	Overload causes redundancy failure.	Decrease some critical loads and reset redundancy.
39	INPUT TRANSFORMER OVER HEAT	<ol style="list-style-type: none"> 1. Fans have abnormalities. 2. Foreign matter is stuck in the fans. 3. The UPS is overloaded. 	Check if fans work abnormally or foreign matter is blocking a fan. If yes, contact service personnel. If not, decrease some critical loads.
40	OUTPUT TRANSFORMER OVER HEAT	<ol style="list-style-type: none"> 1. Fans have abnormalities. 2. Foreign matter is stuck in the fans. 3. UPS is overloaded. 	Check if fans work abnormally or foreign matter is blocking a fan. If yes, contact service personnel. If not, decrease some critical loads.

No.	Alarm Message	Possible Cause	Solution
41	LCM COMMUNICATION LOSS	<ol style="list-style-type: none"> 1. LCM cable is not firmly connected. 2. LCM communication circuit is abnormal. 	<ol style="list-style-type: none"> 1. Check if the LCM cable is firmly connected. If not, connect it firmly. 2. If the LCM cable is firmly connected but the alarm still exists, the LCM communication circuit might have abnormalities. Please contact service personnel.
42	PWR MODULE #n NOT CALIBRATED	EEPROM is damaged.	Contact service personnel.
43	SYSTEM COMMUNICATION NOK	System's communication circuit is abnormal.	Contact service personnel.
44	OUTPUT OVERLOAD WARNING	The UPS is overloaded.	Decrease some critical loads.
45	OUTPUT OVERLOAD SHUTDOWN	The UPS is overloaded.	Decrease some critical loads.
46	PWR MODULE #n ABNORMAL CHANGE	Power Module's control circuit is abnormal.	Contact service personnel.
47	OUTPUT BREAKER OFF	The Output Breaker (Q4) is switched OFF.	<ol style="list-style-type: none"> 1. Check if the Output Breaker (Q4) is switched OFF. If yes, turn it ON. 2. If the Output Breaker (Q4) is turned ON but the alarm still exists, contact service personnel.
48	BATTERY BREAKER OFF	Battery circuit breaker is switched OFF.	<ol style="list-style-type: none"> 1. Check if the battery circuit breaker is switched off. If so, turn it ON. 2. If the battery circuit breaker is turned ON but the alarm still exists, contact service personnel.
49	EXT PARALLEL UNCOMPATIBLE	The firmware versions between parallel UPSs are not compatible.	Contact service personnel.
50	FRAME OVER AUTO RECOVER LIMIT	System's repeated auto protection frequency is over limit.	Contact service personnel.
51	PWR MODULE #n OVER AUTO RECOVER LIMIT	Power Module's repeated auto protection frequency is over limit.	Contact service personnel.
52	OUT OF ECO RANGE	Bypass voltage or frequency is out of ECO Mode limit.	Check the bypass voltage and frequency. If abnormal, contact service personnel.

No.	Alarm Message	Possible Cause	Solution
53	SYSTEM FAN FAIL	<ol style="list-style-type: none"> 1. STS Module's fans have abnormalities. 2. Foreign matter is stuck in the STS Module's fans. 	Contact service personnel.
54	BYPASS STS REPAIR SWITCH OPENED	STS Module's latch is not properly locked.	Check and ensure the STS Module's latch is properly locked. If the alarm still exists, contact service personnel.
55	CONTROL MODULE MICRO SWITCH OPENED	Control Module's latch is not properly locked.	Check and ensure the Control Module's latch is properly locked. If the alarm still exists, contact service personnel.
56	BATTERY FUSE OPEN	Battery fuse is blown.	Contact service personnel.
57	BYPASS STS FUSE OPEN	STS Module's fuse is blown.	Contact service personnel.
58	BYPASS STS GENERAL FAIL	STS Module has an internal fault.	Contact service personnel.
59	MAINS INPUT BREAKER OFF	The Main Input Breaker (Q1) is switched OFF.	Make sure the Main Input Breaker (Q1) is turned ON. If the alarm still exists, contact service personnel.
60	BYPASS BREAKER OFF	The Bypass Breaker (Q2) is switched OFF.	Make sure the Bypass Breaker (Q2) is turned ON. If the alarm still exists, contact service personnel.
61	PWR MODULE #n REPAIR SWITCH OPENED	Power Module's latch is not properly locked.	Make sure the Power Module's latch is properly locked. If the alarm still exists, contact service personnel.
62	PWR MODULE #nn BATTERY FUSE OPEN	Power Module's battery fuse is blown.	Contact service personnel.
63	INHIBIT ECO TRANSFER	Bypass source quality is not good.	Please check the bypass source.
64	PWR MODULE #nn CHARGER FUSE BLEW	Charger is abnormal.	Contact service personnel.
65	RPDC#n Ln INPUT VOLTAGE ABNORMAL	<ol style="list-style-type: none"> 1. Input voltage is out of spec. 2. Input wiring is missing. 	<ol style="list-style-type: none"> 1. Please check the input voltage. 2. Please check if the input wiring is well connected.
66	RPDC#n TOTAL INPUT NEUTRAL CURRENT HIGH	Overload	<ol style="list-style-type: none"> 1. Please reduce the critical loads. 2. Please contact your service personnel.

No.	Alarm Message	Possible Cause	Solution
67	RPDC#n Ln INPUT CURRENT HIGH	Overload	Please reduce the critical loads.
68	RPDC#n Ln INPUT CURRENT IS OVER LIMIT	Overload	Please reduce the critical loads.
69	RPDC#n Ln INPUT CURRENT LOW	Total loads are lower than the setup range.	1. Please check the critical loads. 2. Please check wiring.
70	RPDC#n SYSTEM OVERLOAD	Overload	1. Please reduce the critical loads. 2. Please check wiring.
71	RPDC#n SYSTEM ENVIRONMENT TEMP HIGH	Fans have abnormalities or vents are blocked.	1. Please check the fans and vents. 2. Please decrease the ambient temperature.
72	RPDC#n INPUT POWER ABNORMAL	System abnormal	Please contact your service personnel.
73	RPDC#n FRAM ABNORMAL	System abnormal	Please contact your service personnel.
74	RPDC#n FAN#n FAIL	1. Dust is in fans or fans are blocked. 2. Fans are damaged.	1. Please clean the fans. 2. Please check the fan fuse. 3. Please contact your service personnel.
75	RPDC#n B#nn CIRCUIT BREAKER OPEN	Overload	1. Please reduce the critical loads. 2. Please contact your service personnel.
76	RPDC#n B#nn CURRENT HIGH	Total loads are out of range.	Please reduce the critical loads.
77	RPDC#n B#nn CURRENT LOW	Total loads are lower than the setup range.	1. Please check the critical loads. 2. Please check wiring.
78	RPDC#n COMMUNICATION FAIL	1. Communication wire is not well connected. 2. System failure.	1. Please reconnect the communication wire and confirm that it is firmly connected. 2. Please contact your service personnel.



NOTE: If all possible causes are eliminated but the alarm still appears, please contact your local dealer or customer service.

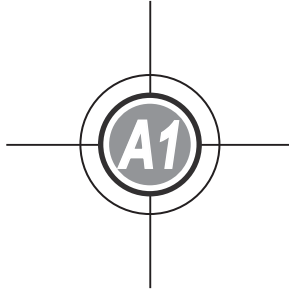

Technical Specifications

Model		DPH 75		
Power Rating		25kVA/KW	50kVA/kW	75kVA/KW
Input	Nominal Voltage	220/380V, 230/400V, 240/415V (3-phase, 4-wire + G)		
	Voltage Range	140 ~ 276/242 ~ 477 Vac *1		
	Current Harmonic Distortion	$\leq 3\%$ *2		
	Power Factor	>0.99		
	Frequency Range	45 ~ 65 Hz		
Output	Voltage	220/380V, 230/400V, 240/415V (3-phase, 4-wire + G)		
	Voltage Harmonic Distortion	$\leq 2\%$ (linear load)		
	Voltage Regulation	$\pm 1\%$ (static)		
	Power Factor	1		
	Frequency	50/60 ± 0.05 Hz		
	Frequency Regulation	± 0.05 Hz (battery mode)		
	Overload Capability	$\leq 125\%$: 10 minutes; $\leq 150\%$: 1 minute		
Display		LED indicators; LCD (Multi-language supported)		
Interface	Standard	System communication port x 1, LCM port x 1, Parallel port x 2, Smart slot x 2, Input dry contact x 2 (sets), Output dry contact x 6 (sets), Battery dry contact x 2 (sets)		
Efficiency	Normal Mode	up to 96%		
	ECO Mode	up to 99%		
Battery	Nominal Voltage	± 240 Vdc		
	Charge Voltage	Float charge: $\pm 272V$; Boost charge: $\pm 288V$		
	Protection of Battery Deep Discharge	Yes		
Environment	Operating Temperature	0 ~ 40°C		
	Relative Humidity	90% (non-condensing)		
	Audible Noise	<62 dBA in normal mode (at a distance of 1 meter in front of the UPS)		
	Protection (IP Degree)	IP 20		
Others	Parallel Redundancy	Yes (up to 4 units)		
	Emergency Power Off	Yes (local and remote)		
	Battery-start	Yes		

Model		DPH 75	
Physical	Dimensions (W x D x H)		600 x 1090 x 2000 mm
	Weight	UPS System	310 kg
		Power Module	32 kg
		Rack-mount PDC	32 kg (Maximum)
System Frame Maximum Capacity	25kW Power Module		3
	Battery Module		4
	Rack-Mount PDC		1
	Hot-Swappable Breaker Module (for Rack-mount PDC)		6



NOTE:

1. Please refer to the rating label for the safety rating.
2. All specifications are subject to change without prior notice.

*1: When input voltage is 140/242 ~176/300Vac, the suitable loading is from 55% to 100% of the UPS capacity.

*2: When input vTHD is <1%.

The logo consists of a central circle containing the text 'A2'. This circle is surrounded by a larger, thin-lined circle. Four thin lines extend from the center of the circles to the top, bottom, left, and right edges, forming a crosshair.

Warranty

Seller warrants this product, if used in accordance with all applicable instructions, to be free from original defects in material and workmanship within the warranty period. If the product has any failure problem within the warranty period, Seller will repair or replace the product at its sole discretion according to the failure situation.

This warranty does not apply to normal wear or to damage resulting from improper installation, operation, usage, maintenance or irresistible force (i.e. war, fire, natural disaster, etc.), and this warranty also expressly excludes all incidental and consequential damages.

Maintenance service for a fee is provided for any damage out of the warranty period. If any maintenance is required, please directly contact the supplier or Seller.



WARNING!

The individual user should take care to determine prior to use whether the environment and the load characteristic are suitable, adequate or safe for the installation and the usage of this product. The User Manual must be carefully followed. Seller makes no representation or warranty as to the suitability or fitness of this product for any specific application.

No. 501321460102
Version : V 1.2
Release Date : 2020_8_26

- Global Headquarter

Taiwan

Delta Electronics Inc.
39 Section 2, Huandong Road, Shanhua District,
Tainan City 74144, Taiwan
T +886 6 505 6565
E ups.taiwan@deltaww.com

- Regional Office

The United States

Delta Electronics (Americas) Ltd.
46101 Fremont Blvd. Fremont, CA 94538
T +1 510 344 2157
E ups.na@deltaww.com

Australia

Delta Energy Systems Australia Pty Ltd.
Unit 20-21, 45 Normanby Road, Notting Hill VIC 3168, Australia
T +61 3 9543 3720
E ups.australia@deltaww.com

South America

Delta Greentech (Brasil) S/A
Rua Itapeva, 26 - 3º andar Edifício Itapeva One - Bela Vista
01332-000 - São Paulo - SP - Brazil
T +55 11 3568 3850
E ups.brazil@deltaww.com

Thailand

Delta Electronics (Thailand) Public Co.,Ltd.
909 Soi 9, Moo 4, E.P.Z., Bangpoo Industrial Estate, Tambon Prakasa,
Amphur Muang-samutprakarn, Samutprakarn Province 10280, Thailand
T +662 709-2800
E ups.thailand@deltaww.com

China

Delta GreenTech (China) Co., Ltd.
238 Minxia Road, Pudong, Shanghai, 201209 P.R.C
T +86 21 5863 5678
+86 21 5863 9595
E ups.china@deltaww.com

South Korea

Delta Electronics (Korea), Inc.
1511, Byucksan Digital Valley 6-cha, Gasan-dong, Geumcheon-gu,
Seoul, Korea, 153-704
T +82-2-515-5303
E ups.south.korea@deltaww.com

Singapore

Delta Electronics Int'l (Singapore) Pte Ltd.
4 Kaki Bukit Ave 1, #05-04, Singapore 417939
T +65 6747 5155
E ups.singapore@deltaww.com

India

Delta Power Solutions (India) Pvt. Ltd.
Plot No. 43, Sector-35, HSIIDC, Gurgaon-122001, Haryana, India
T +91 124 4874 900
E ups.india@deltaww.com

EMEA

Delta Electronics (Netherlands) BV
Zandsteen 15, 2132MZ Hoofddorp, The Netherlands
T +31 20 655 09 00
E ups.netherlands@deltaww.com



5013214601