

The power behind competitiveness

# Delta InfraSuite EMS

Environmental Management System  
EnviroStation

User Manual

[www.deltapowersolutions.com](http://www.deltapowersolutions.com)



**DELTA**  
Smarter. Greener. Together.

## Save This Manual

This manual contains important instructions and warnings that you should follow during the installation, operation, storage and maintenance of this product. Failure to heed these instructions and warnings will void the warranty.

Copyright © 2013 by Delta Electronics Inc. All Rights Reserved. All rights of this User Manual (“Manual”), including but not limited to the contents, information, and figures are solely owned and reserved by Delta Electronics Inc. (“Delta”). The Manual can only be applied to the operation or the use of this product. Any disposition, duplication, dissemination, reproduction, modification, translation, extraction, or usage of this Manual in whole or in part is prohibited without the prior written permission of Delta. Given that Delta will continuously improve and develop the product, changes may be made to the information in this Manual at any time without obligation to notify any person of such revision or changes. Delta will make all possible efforts to secure the accuracy and the integrity of this Manual. Delta disclaims any kinds or forms of warranty, guarantee, or undertaking, either expressly or implicitly, including but not limited to the completeness, faultlessness, accuracy, non-infringement, merchantability or fitness for a particular purpose of the Manual.

# Table of Contents

<b>CHAPTER 1 : IMPORTANT SAFETY INSTRUCTIONS .....</b>	<b>1</b>
1.1.    SAFETY WARNINGS .....	1
1.2.    USAGE WARNINGS .....	1
1.3.    STANDARD COMPLIANCE .....	2
<b>CHAPTER 2 : INTRODUCTION .....</b>	<b>3</b>
2.1.    PRODUCT DESCRIPTION .....	3
2.2.    FEATURES.....	3
2.3.    PACKAGE CONTENTS .....	5
2.4.    INTERFACE.....	7
<b>CHAPTER 3 : INSTALLATION .....</b>	<b>10</b>
3.1.    RACK-MOUNT INSTALLATION.....	10
3.2.    RS485 .....	11
3.3.    ENVIROPROBE .....	12
3.4.    DIGITAL INPUT .....	13
3.5.    SENSOR HUB .....	14
3.6.    ANALOG INPUT .....	16
3.7.    RELAY OUTPUT .....	17
3.8.    ALARM BEACON.....	17
3.9.    PDU INSTALLATION.....	18
<b>CHAPTER 4 : SYSTEM CONFIGURATIONS .....</b>	<b>20</b>
4.1.    CONFIGURING VIA INSIGHTPOWER SNMP IPV6 FOR ENVIROSTATION WEB.....	20
4.2.    CONFIGURING WITH EZSETTING .....	22
4.3.    CONFIGURING VIA TELNET .....	24
4.4.    CONFIGURING THROUGH COM PORT.....	24
4.5.    CONFIGURING VIA TEXT MODE .....	26
<b>CHAPTER 5 : INSIGHTPOWER SNMP IPV6 FOR ENVIROSTATION WEB.....</b>	<b>33</b>

5.1	MONITOR.....	34
5.1.1.	<i>Information</i> .....	34
	Status .....	34
	Delta Bus .....	35
	RS485 .....	35
	PDU .....	36
	IPMI.....	36
5.1.2.	<i>History</i> .....	37
	Event Log.....	37
	Energy Log.....	38
	Energy Compare.....	39
	Data Log .....	39
	Configuration .....	40
5.1.3.	<i>About</i> .....	41
	Information .....	41
5.2	DEVICE.....	42
5.2.1.	<i>Management</i> .....	42
	Sensor HUB .....	42
	Digital Input.....	43
	Analog Input.....	44
	Relay Output .....	45
	Delta Bus .....	45
	RS485 .....	48
	Protocol.....	49
	PDU .....	50
	IPMI Device .....	50
	IPMI Template .....	52
	Reaction .....	54

5.3	SYSTEM.....	55
5.3.1.	<i>Administration</i> .....	55
	User Manager .....	55
	TCP/ IP .....	56
	Web.....	57
	Console .....	59
	FTP .....	60
	Time Server.....	60
	Syslog .....	61
	Batch Configuration .....	62
	Upgrade.....	63
5.3.2.	<i>Notification</i> .....	64
	SNMP Access .....	64
	SNMPv3 USM .....	65
	SNMP Trap.....	65
	Mail Server .....	66
<b>CHAPTER 6 : SNMP DEVICE FIRMWARE UPGRADE.....</b>		<b>68</b>
<b>CHAPTER 7 : TROUBLESHOOTING .....</b>		<b>71</b>
<b>APPENDIX A : SPECIFICATIONS.....</b>		<b>78</b>
<b>APPENDIX B : WARRANTY .....</b>		<b>79</b>

# Chapter 1 : Important Safety Instructions

## 1.1. Safety Warnings

Before installation,

- Ensure that the power cord plug and socket are in good condition.
- Make sure that the power source to the EnviroStation is rated between 100-240V and is well grounded.

## 1.2. Usage Warnings

- This unit is designed for indoor use only. Install it in a well-controlled environment away from excessive moisture, temperature extremes, conductive contaminants, dust or direct sunlight.
- Do not place or use this unit in the presence of flammable substances.
- Do not attempt to disassemble the unit which contains potentially hazardous voltages. Only trained technicians are allowed to perform this action.
- Do not attempt to perform any internal modifications on the unit.
- Do not attempt to fix/ replace internal components. When repair is needed, refer all servicing to the nearest Delta service center or authorized distributor.
- Do not allow any objects or liquids of any kind to penetrate the unit.
- Always follow this User Manual to install and operate this unit.
- Disconnect all external devices before moving this unit.
- Do not play the included CD-ROM on a conventional CD player. This could generate loud noise at a level that could result in permanent hearing loss.

## 1.3. Standard Compliance

- **Network**

- IPv6 Phase-2**

- Application ID: TW-2-C-20100323-000158



- **CE**

- EMI**

- EN55022 (CISPR 22) Class A

- EMS**

- EN55024

- IEC 61000-4-2 (ESD Test)                      Level 3 @ Air 8 KV/ Contact 4 KV
    - IEC 61000-4-3 (RS Test)                      Level 2 @ 3 V/m
    - IEC 61000-4-4 (EFT Test)                      Level 2 @ 5 KHz/ 1KV
    - IEC 61000-4-6 (CS Test)
    - IEC 61000-4-5 (Surge Test)                      Level 2 @ 1.2\*50/ 8\*20 us  
L-N 2 ohm 1 KV  
L-PE/ N-PE/ L+N-PE 12 ohm 2 KV

# Chapter 2 : Introduction

## 2.1. Product Description

The EnviroStation monitors and controls environmental conditions through peripheral devices to ensure that your equipment is protected from critical conditions such as high temperature, humidity or water leakage. This rack-mountable product works seamlessly with temperature and humidity sensor EnviroProbes (optional) and other environment monitoring devices.

## 2.2. Features

- **Working with multiple EnviroProbes**

The EnviroProbes are designed to work with the EnviroStation. There are three types of EnviroProbes, (1) EnviroProbe 1000 (EMS1000), (2) EnviroProbe 1100 (EMS1100) and (3) EnviroProbe 1200 (EMS1200). The EnviroProbe (EMS1000) has one temperature/ humidity sensor and four digital inputs. The EnviroProbe 1100 (EMS1100) has four digital outputs, and the EnviroProbe 1200 (EMS1200) has two analog inputs, one analog output and one water-leakage detection. To extend the monitoring and detection scope, up to 10 of EMS1000s or 4 of EMS1100s or 5 of EMS1200s can be cascaded with a maximum distance of 400 meters.

- **Smart monitoring and event notification**

With peripheral devices, the EnviroStation monitors environment variables and informs you of event occurrences based on severity that may call for your administrative attention. It also takes necessary actions according to your configuration.

- **Event and data log keeping**

Offers extensive records of system and environment status.

- **Handy configuration tool EzSetting**

Compatible with Windows systems, EzSetting allows you quick and effortless setup via a user-friendly interface.



- **Network connection through RJ45 connector**

Direct network connection through an RJ45 cable offers immediate configuration via your local network environment with comprehensive management capabilities networking security.

- **Compatibility with SNMP (Simple Network Management Protocol), HTTP and HTTPS**

Works with universal protocols including SNMP, HTTP and HTTPS.

- **Direct COM Port connection**

Lets you manage your EnviroStation even when a network connection is not available.

- **Working with up to 16 PDU devices**

EnviroStation monitors each PDU's load, frequency, watt, accumulated power consumption, etc.

- **IPMI supported**

Supports IPMI version 1.5 & version 2.0.

- **Flexible reaction setup**

You can create your own reaction rules. Based on the input conditions of Digital Input, Analog Input, Sensor HUB, PDU, EnviroProbe or RS485, the EnviroStation controls the actions of output devices such as Digital Output, EnviroProbe or RS485.

**Other features and supported protocols include:**

- User notification via SNMP Traps
- Simple Network Time Protocol
- Simple Mail Transfer Protocol
- Remote event log management through syslog
- Network Time Protocol
- Configuration via Telnet/ text mode
- BOOTP/ DHCP
- IPv4 and IPv6
- HTTPS, SSH, SFTP and SNMPv3 security protocols
- RADIUS (Remote Authentication Dial In User Service) login

## Signal Flow

The following figure explains how EnviroStation monitors and processes signals.

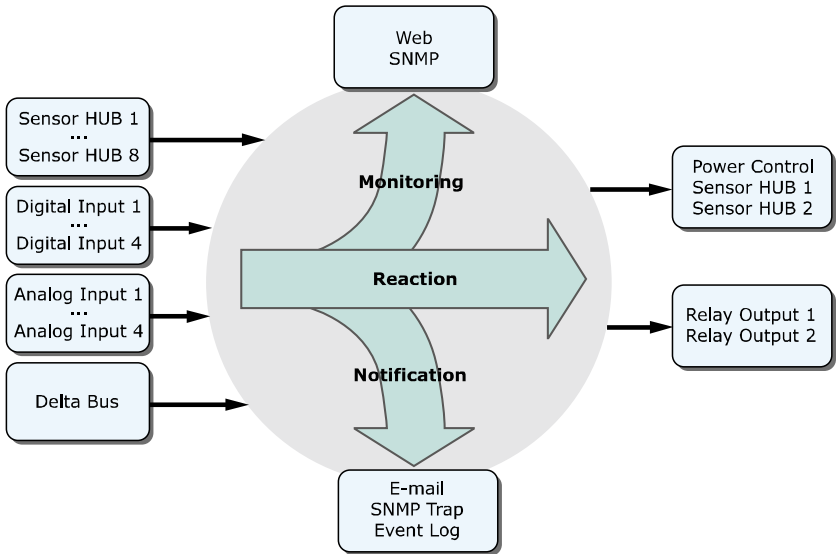

## 2.3. Package Contents

Please carefully verify EnviroStation and the included accessories. Contact your dealer if any item is missing or damaged. Should you return the items for any reason, ensure that they are carefully repacked using the original packing materials that came with the unit.

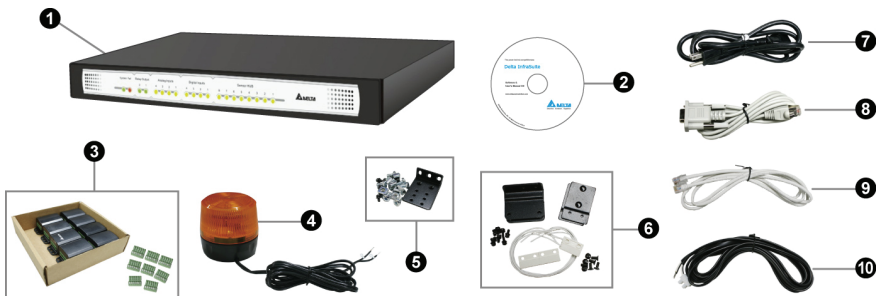

No.	Item	Quantity
❶	EnviroStation	1 PC
❷	Manual and software CD	1 PC
❸	Sensor HUB adapter	8 PCS
	Terminal block (for Sensor HUB adapter)	8 PCS
❹	Alarm Beacon	1 PC
❺	Bracket ear (including cage nuts and screws)	1 SET
❻	Door contact sensor	1 SET
❼	AC power cord	1 PC
❽	RJ45 to DB9 cable	1 PC
❾	Standard CAT5 cable	1 PC
❿	Extension cable (for leakage sensor)	1 PC

**You will need the following items:**

Peripheral devices such as temperature/ humidity/ water leakage sensors and EnviroProbes are not included in the package. Also, additional Standard CAT5 cables used to cascade EnviroProbes are not included. You will need to obtain these items separately.

## 2.4. Interface

The LED indicators and connectors on the front and rear panel are shown as follows. For their functions and indications, please refer to the table below.

### Front panel:

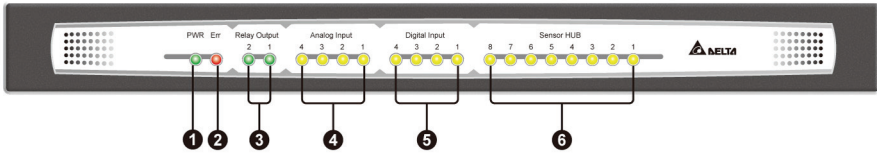

### Rear panel:

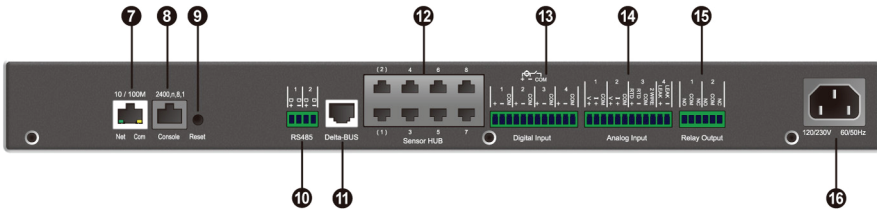

No.	Item	Description
❶	Power LED	Indicates whether the unit is connected to a power source. <ul style="list-style-type: none"> <li>● On (green): Connected.</li> <li>● Off: Not connected.</li> </ul>
❷	Fault LED	Indicates whether an internal fault has occurred. <ul style="list-style-type: none"> <li>● On (red): Fault occurred.</li> <li>● Off: Normal.</li> </ul>
❸	Relay Output LEDs	<ul style="list-style-type: none"> <li>● On (green): The Relay Output is switched to NC (Normal Close).</li> <li>● Off: The Relay Output is switched to NO (Normal Open).</li> </ul>
❹	Analog Input LEDs	<ul style="list-style-type: none"> <li>● On (yellow): The value of the Analog Input is out of the assigned normal range.</li> <li>● Off: The value of the Analog Input is in the normal range.</li> </ul>
❺	Digital Input LEDs	<ul style="list-style-type: none"> <li>● On (yellow): The Digital Input is activated and defined as 'Warning' or 'Alarm'.</li> </ul>

No.	Item	Description
		<ul style="list-style-type: none"> <li>● Off: The Digital Input is defined as 'None' or 'Information'.</li> </ul>
6	Sensor HUB LEDs	<ul style="list-style-type: none"> <li>● On (yellow): The Sensor HUB is activated and defined as 'Warning' or 'Alarm'.</li> <li>● Off: The Sensor HUB is defined as 'None' or 'Information'.</li> </ul>
7	10/ 100 Base-T Network Port	<p>Connects the EnviroStation to the network.</p> <ol style="list-style-type: none"> <li>1. When the EnviroStation initializes or upgrades its firmware, the two LED indicators on the 10/ 100 Base-T network port flash simultaneously. Please refer to the following for LED illumination definition. <ul style="list-style-type: none"> <li>● <b>Rapid simultaneous flashing</b> (every 50ms): Initialization or firmware upgrade in progress.</li> <li>● <b>Slow simultaneous flashing</b> (every 500ms): Initialization failure.</li> </ul> </li> </ol> <p> <b>Warning :</b> Do <b>NOT</b> disconnect the EnviroStation's input power during initialization or firmware upgrade! This could result in data loss or damage to the EnviroStation.</p> <ol style="list-style-type: none"> <li>2. The green LED indicator shows the network connection status: <ul style="list-style-type: none"> <li>● <b>ON</b>: Network connection established and the IPv4 address is useable.</li> <li>● <b>OFF</b>: Not connected to a network.</li> <li>● <b>Flashes slowly</b> (every 500ms): Faulty IP address.</li> </ul> </li> <li>3. The yellow LED indicator shows the linking status: <ul style="list-style-type: none"> <li>● <b>Flashes rapidly</b> (every 50ms): Linking normal.</li> <li>● <b>Flashes slowly</b> (every 500ms): Linking abnormal.</li> </ul> </li> </ol>
8	Console Port	Connects to a workstation with an RJ45 to DB9 cable.
9	Reset Button	Resets the EnviroStation's network module. This will not affect the operation of other connected devices.
10	Modbus RS485 port	Connects devices to EnviroStation via the Modbus protocol.

No.	Item	Description
11	Delta-BUS	Provides power (12Vdc) and connects to EnviroProbe(s) using a standard CAT5 cable with straight-through wiring.
12	Sensor HUB	Connects and provides power (12/ 24Vdc) to general sensor devices using standard CAT5 cables with straight-through wiring.
13	Digital Input	Four input contact devices can be connected to EnviroStation. The wet contact active rating is 5~24Vdc, 1~9mA.
14	Analog Input	Connects four analog sensor devices, including: <ul style="list-style-type: none"> <li>● Two 0-10Vdc analog voltage sensors or 0-20mA current-loop sensors.</li> <li>● 1 RTD sensor.</li> <li>● 1 leakage sensor.</li> </ul>
15	Relay Output	Connects to relay-controlled devices.
16	AC Line Inlet	Provides power to EnviroStation. The range is 100V~240V 60/50Hz.

## Chapter 3 : Installation

In this chapter, you will learn the installation procedures for the EnviroStation, EnviroProbes, Alarm Beacon, and devices connecting via RS485, Sensor HUB, Digital Inputs, Analog Inputs and Relay Outputs.

### 3.1. Rack-mount Installation

**Step 1** Choose a location in the rack. On the vertical mounting rails, insert the provided cage nuts.

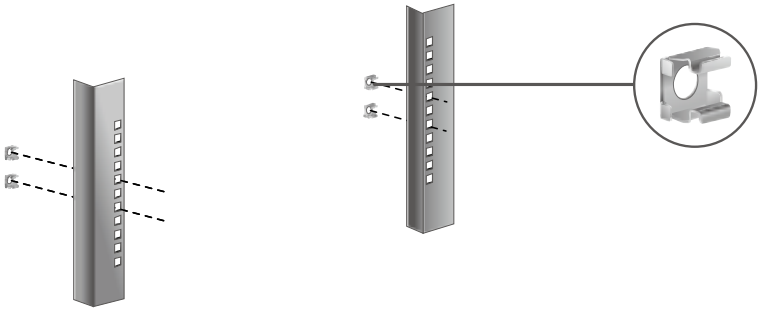

**Step 2** Using two screws, attach two bracket ears provided in the accessory box to each end of the EnviroStation.

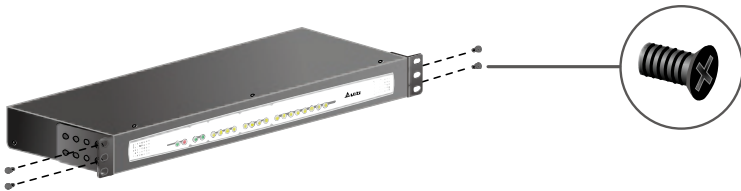

**Step 3** Make sure the mounting holes and the bracket ears on the EnviroStation are aligned properly, then secure the bracket ears to the rack with the four provided mounting screws (two for each end), EnviroStation occupies 1U of rack space.

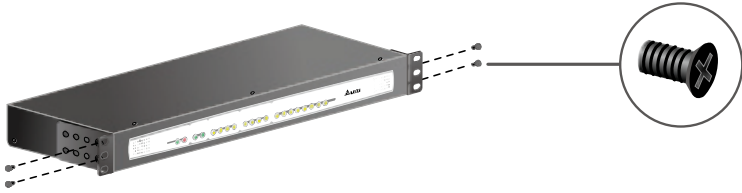

**Step 4** Connect the AC power cable from the rear panel to an unoccupied power outlet. This will automatically power up the EnviroStation.



**WARNING:**

Before connecting the EnviroStation to a power source, make sure that the power source is rated between 100-240V and is well grounded.

### 3.2. RS485

EnviroStation provides two RS485 ports for devices that communicate through the Modbus protocol such as power meters and door contact systems. Using an RS485 port, eight devices with different ID numbers can be cascaded, however, their communication parameters must be identical (For example: Baud rate: 2400, data bits: 8, parity: none, stop bits: 1, and flow control: None).

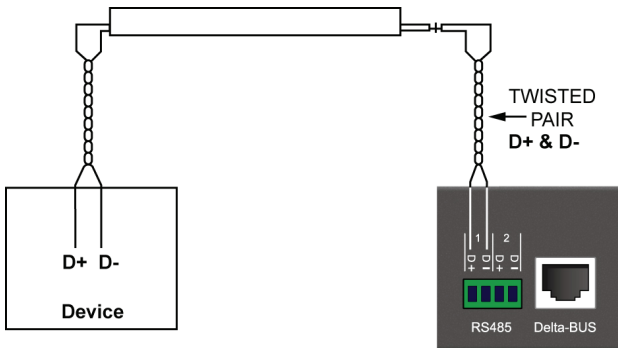



### 3.3. EnviroProbe

Detecting environment temperature and humidity, the EnviroProbes are designed to work with the EnviroStation. You can cascade multiple EnviroProbes to extend the detecting range. To install the EnviroProbe(s), please see the following instructions.

**Step 1** Set the **Comm** DIP switch to **Station** on the EnviroProbe(s).

**Step 2** Make sure the last EnviroProbe in the chain (the farthest) is set to **Rt-Yes**, and the rest of the EnviroProbes are set to **Rt-No**. If only one EnviroProbe is connected, please also make sure that it is set to **Rt-Yes**.

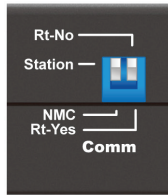

**Step 3** Set the ID DIP switch to assign an ID for each EnviroProbe (please refer to the EnviroProbe User Manual). No particular numeric order is required for the connected units; however, make sure that each EnviroProbe is assigned with a unique ID. Up to ten EnviroProbes can be cascaded.

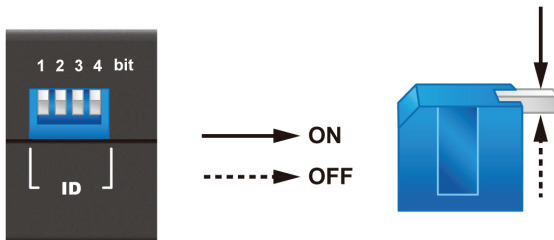

**Step 4** Attach the EnviroProbe(s) to rack cabinet doors or metal plates.

**Step 5** Use a standard CAT5 cable to connect the first (nearest) EnviroProbe's **Input** to the **Delta-BUS** port on the rear panel.

**Step 6** Cascade other EnviroProbes using standard CAT5 cables. Connect the **Output** port to the next EnviroProbe's **Input** port. Please see the figure below.

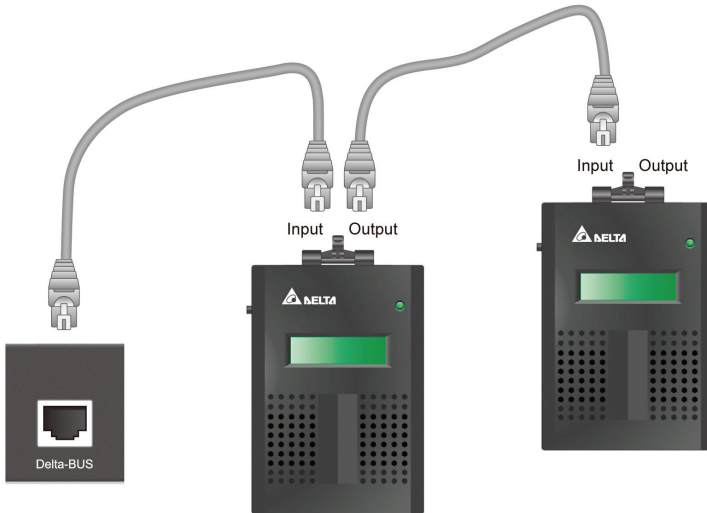

**WARNING:**

Under no circumstance should you connect the EnviroProbe's Input port to another one's Input port. This may cause unrecoverable malfunction to your EnviroProbes. Please be careful and always make sure that you are connecting the correct ports before you plug in.

### 3.4. Digital Input

The EnviroStation provides four Digital Inputs. Wet and Dry Contacts can be connected for applications such as smoke, fire and door security detection. To connect your peripheral devices, please refer to the following figures for terminal connections:

Digital Value	Dry Contact	Wet Contact
1	Close	5~24Vdc
0	Open	< 1.5Vdc

- **Dry Contact** : Normal Open [NO] or Normal Close [NC].

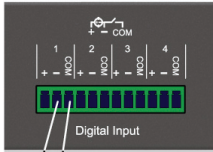

Normal Open, contact close for alarm

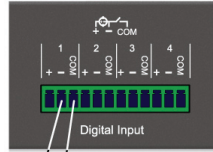

Normal Close, contact open for alarm

- **Wet Contact**: Active rating 5~24Vdc, 1~9mA.

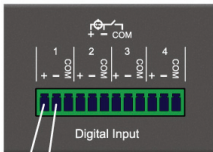

Normal Open, supply power for alarm

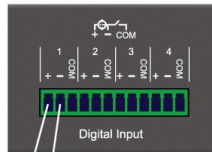

Normal Close, cut off power for alarm

### 3.5. Sensor HUB

In the accessory box you can find eight provided Sensor HUB adapters (RJ45 to 6-pin terminal connector) which are used to connect peripheral devices for purposes such as smoke, fire and door contact detection. To connect a Sensor HUB device, please see the following instructions:

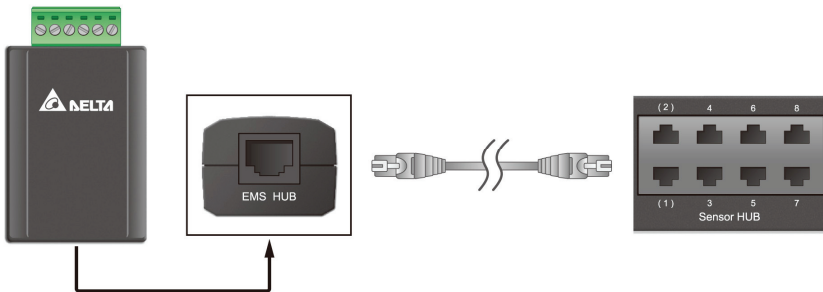

- Connect a Sensor HUB adapter to a Sensor HUB port on the rear panel with a standard CAT5 cable.
- On the other side of the adapter, plug a 6-pin terminal block (provided with the package) into the green terminal connector so wires from peripheral devices can be tightened and fixed with the screws.
- Depending on the contact types and power requirement of the devices you are connecting, different terminal connections are required. Please see the following figures:

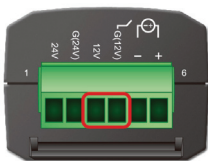

- 1) +12Vdc is provided by connecting the following two terminal points: **12V** and **G (12V)**.

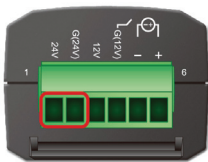

- 2) +24Vdc is provided by connecting the following two terminal points: **24V** and **G (24V)**.



- 3) Connect Dry Contact signal to **G (12V)** and – terminal points.

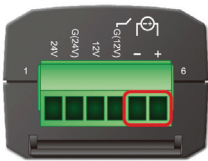

- 4) Connect Wet Contact signal to + and – terminal points. The active rating is 5~24Vdc, 1~9mA.



**NOTE:**

For HUB1/ HUB2, you can manually turn on/ off power or enable automatic power control. Please see **5.2.1 Management – Sensor HUB**.

### 3.6. Analog Input

The EnviroStation provides four Analog Inputs, which are generally used to connect sensor devices that monitor the environment by observing voltage or current fluctuations. The Analog Input 1 and 2 can be connected to a voltage (0~10Vdc) or current (0~20mA) source. Please see the following illustrations.

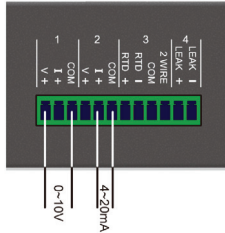

The Analog Input 3 is dedicated to a 2-wire or 3-wire RTD (Resistance Temperature Detector) input. You can connect a PT100 (2/3-wire) temperature sensor to it. Please see the figure below:

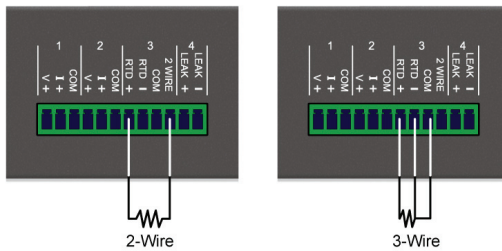

The Analog Input 4 is designed to connect a leakage sensor for leakage detection. You can use the provided extension cable to extend its length.

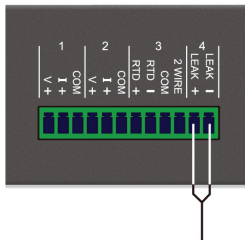

### 3.7. Relay Output

EnviroStation provides two Relay Outputs which can be used in cooperation with Digital/ Analog Input devices to take appropriate actions when events are reported.

The power rating is 26Vdc, 0.8A. Please see the following illustrations for the terminal configurations:

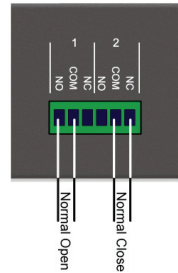

### 3.8. Alarm Beacon

The Alarm Beacon can be installed in visible locations and triggered by specific events to alert you to any unusual situations. To install the Alarm Beacon, a provided terminal block and a Sensor HUB adapter are needed.

**Step 1** Plug the terminal block into the green terminal connector of the Sensor HUB adapter.

**Step 2** Connect the positive wire (+) from the Alarm Beacon to the **12V** terminal on the terminal block, and the negative wire (-) to the **G (12V)** terminal. Make sure that the screws on the connected terminals are tightened properly.

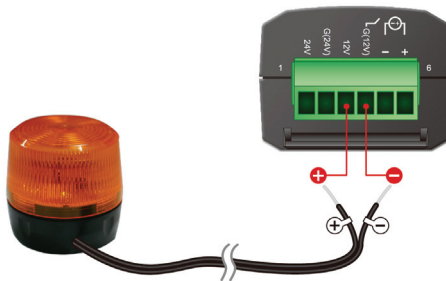

**Step 3** Use a standard CAT5 cable to connect the RJ45 connector of the adapter to the Sensor HUB1/ HUB2 on the rear panel of the EnviroStation.

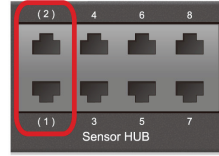
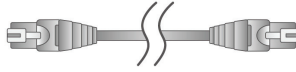
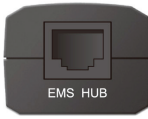

**Step 4** Place the Alarm Beacon in a visible location.

### 3.9. PDU Installation

**Step 1** The EnviroStation can connect with up to 16 PDU devices (different models are allowed). If you wish to cascade PDU devices, please set a unique ID No. (0~15) for each PDU with its own four DIP switches (see **Table 3-1**).

**Table 3-1: Settings of PDU DIP Switches**

PDU DIP Switches	ID Number	PDU DIP Switches	ID Number	PDU DIP Switches	ID Number
ON 1 2 3 4	0	ON 1 2 3 4	6	ON 1 2 3 4	12
ON 1 2 3 4	1	ON 1 2 3 4	7	ON 1 2 3 4	13
ON 1 2 3 4	2	ON 1 2 3 4	8	ON 1 2 3 4	14
ON 1 2 3 4	3	ON 1 2 3 4	9	ON 1 2 3 4	15
ON 1 2 3 4	4	ON 1 2 3 4	10		
ON 1 2 3 4	5	ON 1 2 3 4	11		

**Step 2** Use the provided RJ45-DB9 cable to connect the EnviroStation and your PDU. Connect the RJ45 to the EnviroStation's console port and connect the DB9 to the PDU's RS232-2 port. If you need to cascade several PDU devices, please use the RS232 cables provided in your PDU devices. Please refer to the figure below.

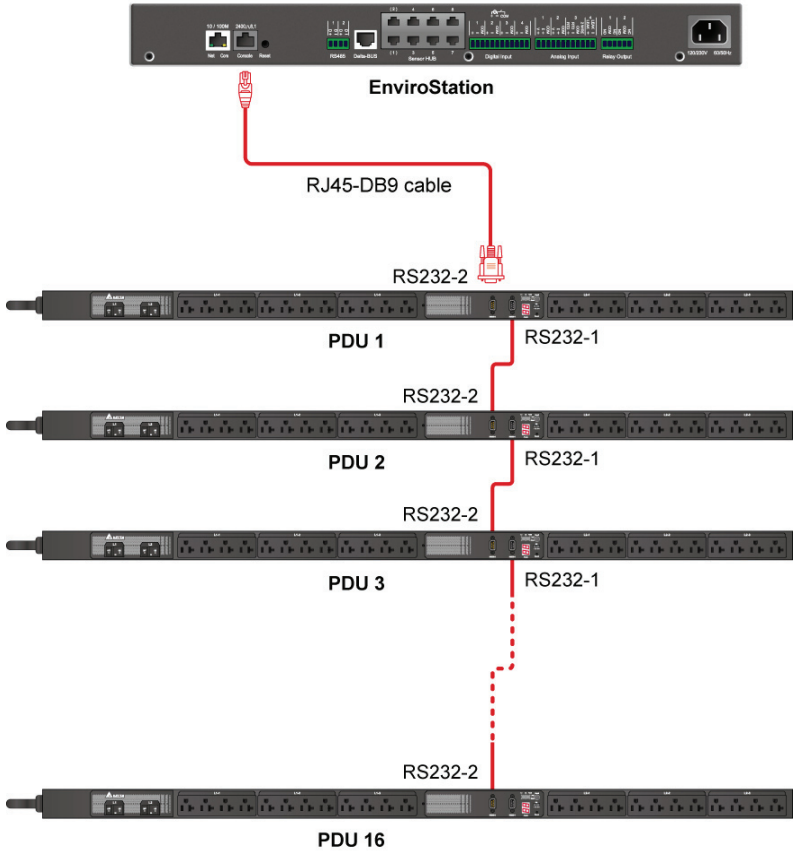

**Step 3** After installation, please visit InsightPower SNMP IPv6 for EnviroStation Web, click **Device**→ **Management**→ **PDU**, and check the **PDU Enable** box. Please note that the text mode will be disabled if you check the **PDU Enable** box.



## Chapter 4 : System Configurations

There are different ways you can configure your EnviroStation. If a network connection is available at your location, the following methods can be used:

- **Web-based interface:** The InsightPower SNMP IPv6 for EnviroStation Web offers comprehensive system management and monitoring. Please refer to **Chapter 5: InsightPower SNMP IPv6 for EnviroStation Web**.
- **EzSetting:** Use the provided program EzSetting to quickly set up your SNMP IPv6. Please refer to **4.2 Configuring with EzSetting**.
- **Telnet mode:** Configure your SNMP IPv6 in text mode. Please refer to **4.3 Configuring via Telnet**.

The above-mentioned methods require network connection. If not available, you can use direct COM port connection to set up your EnviroStation. Please see **4.4 Configuring through COM Port**.



### NOTE:

1. To ensure system security, it is highly recommended that you change your account and password after the first login.
2. If you have multiple EnviroStation units installed in your network, we highly suggest that you change the EnviroStation's default Host Name to avoid conflicts. Also, it is recommended that you disable BOOTP/ DHCP and manually assign a valid static IP address to the EnviroStation.

### 4.1. Configuring via InsightPower SNMP IPv6 for EnviroStation Web

To set up the EnviroStation via your web browser, please follow the instructions below:

- Step 1** Use a CAT5 network cable to connect the EnviroStation's 10/ 100 Base-T network port to the network. Launch your web browser. In the address bar, enter the EnviroStation's default Host Name **InsightPower**, or default IP address **192.168.1.100**. If you are unable to connect, please see **Chapter 7 : Troubleshooting Q6**.

**NOTE:**

If you have previously changed the EnviroStation's Host Name or IP address, connect with the new settings.

**Step 2** Log in as Administrator (default account/ password: admin/ password, case sensitive).

**Step 3** Specify your preferred display language (default: English) from the dropdown menu on the top right of the page. The EnviroStation remembers your language preference. In the following instructions, English is chosen as the display language.

**Step 4** Click **System** → **Administration** → **User Manager**. Manage your login accounts and passwords under the “Local Authentication” subhead. The access permission for the account types are listed as follows:

- 1) Administrator: Allowed to modify all settings.
- 2) Device Manager: Allowed to modify device-related settings.
- 3) Read Only User: Only allowed to view settings without the permission to make changes. .

You can manually specify whether users are allowed to log in from other LANs. If you wish to block login attempts from external connections, selecting Only in this LAN. Otherwise, select Allow Any.

**Step 5** Click **System** → **Administration** → **TCP/ IP** to set Host Name, IP address, Subnet Mask and Gateway IP for the EnviroStation.

**Step 6** Click **Time Server** to manually set time and date for the system, or enable automatic time synchronization between the EnviroStation and the time servers.

**NOTE:**

To completely set up your SNMP IPv6, please refer to **Chapter 5: InsightPower SNMP IPv6 for EnviroStation Web**.

## 4.2. Configuring with EzSetting

Included in the provided CD, the EzSetting (compatible with Windows 2000/ 2003/ 2008/ XP/ Vista/ 7) allows you to easily configure your EnviroStation and upgrade firmware on your SNMP devices. Follow the instructions below:

- Step 1** Use the provided standard CAT5 cable to connect the 10/ 100 Base-T network port from EnviroStation's rear panel to the network.
- Step 2** Make sure the workstation and the EnviroStation are on the same LAN.
- Step 3** Insert the provided CD in the CD-ROM drive. From the root directory, launch **EzSetting**.
- Step 4** Click **Discover** to search all available SNMP devices on the LAN. A list of devices will be shown.

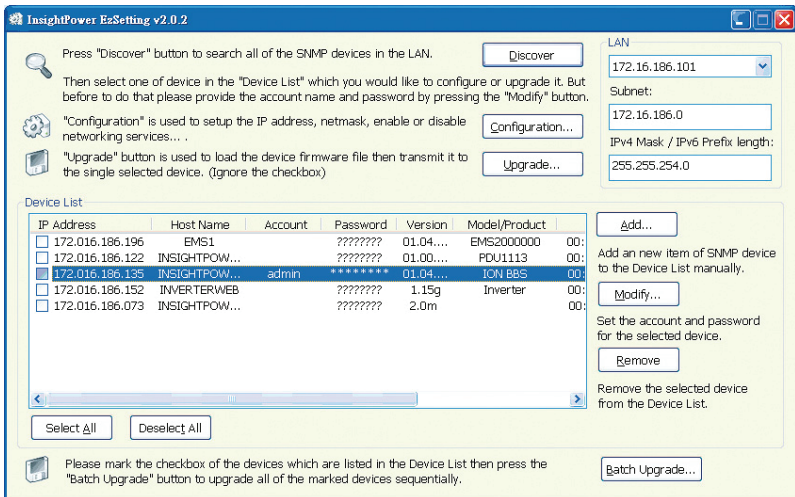

### NOTE:

1. If you want to search SNMP devices in a different domain, change the **Subnet** and **IPv4 Mask / IPv6 Prefix Length** and click **Discover**.
2. If the EnviroStation cannot be found, check UDP port 3456 on the workstation you are using. Make sure it is open.

**Step 5** Select the SNMP device that you want to modify from the **Device List**. Click **Modify** and enter account and password (default: admin/ password, case sensitive).

**Step 6** Click **Configuration** to configure network settings.



**NOTE:**

Refer to **Chapter 5: InsightPower SNMP IPv6 for EnviroStation Web** for complete configurations.

### 4.3. Configuring via Telnet

- Step 1** Use the provided standard CAT5 cable to connect the 10/ 100 Base-T network port from the rear panel to the network.
- Step 2** Connect the workstation (Windows or Linux) to the LAN that the EnviroStation is connected to.
- Step 3** For Windows, launch DOS prompt mode (**Start** → **Run** → key in **cmd** and press **enter**). For Linux, launch shell.
- Step 4** Enter the following command: **telnet InsightPower** or **telnet IP address** to initiate telnet connection with the EnviroStation.
- Step 5** When connection is established, enter **account** and **password** (default: admin/ password, case sensitive). The **Main Menu** will appear on the screen. Please refer to **4.5 Configuring via Text Mode** for more information.



#### NOTE:

1. The EnviroStation will terminate idle connections after 60 seconds.
2. Refer to **Chapter 5: InsightPower SNMP IPv6 for EnviroStation Web** for complete configurations.

### 4.4. Configuring through COM Port

If a network connection is not available at your location, you can still set up the EnviroStation via COM port connection. Please follow the instructions below.



#### NOTE:

If you are running a non-Windows system, refer to your system's User Manual for Telnet client.

- Step 1** Use the provided standard CAT5 cable to connect the 10/ 100 Base-T network port from the rear panel to the network.
- Step 2** For Windows 2000, 2003, 2008 and XP, go to **Start** → **Programs** → **Accessories** → **Communications** and select **HyperTerminal**.



## NOTE:

Microsoft has removed HyperTerminal from Windows Vista and later versions. If your operation system does not include the program, a free alternative Telnet/ SSH client PuTTY can be downloaded from <http://www.putty.org>.

- Step 3** Enter a name, choose an icon for the connection and click **OK**. From the dropdown menu **connect using**, select the **COM port** that is connected to the EnviroStation.

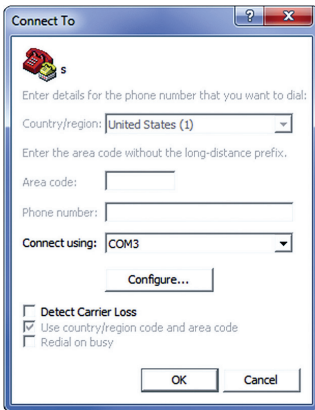

- Step 4** Click **configure** and set up COM port parameters as follows:

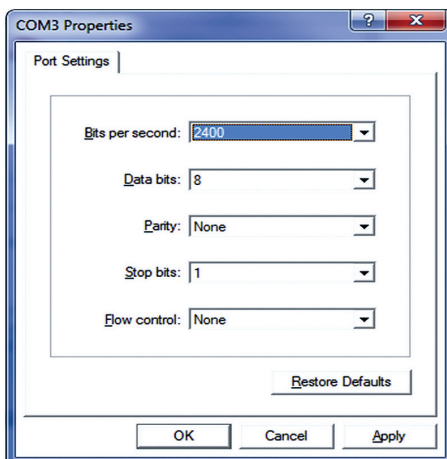

**Step 5** Click **OK** to continue. HyperTerminal will automatically connect to the EnviroStation. If it does not connect, click the telephone icon from the tool bar. When connection is established, log in with account/ password. (Default: admin/ password, case sensitive). Once you are logged in, the **Main Menu** appears on the screen. Please refer to **4.5 Configuring via Text Mode** for more information.

## 4.5. Configuring via Text Mode

You can configure the EnviroStation via text mode by using Telnet/ SSH clients such as HyperTerminal and PuTTY. In this section, you can find descriptions and default settings.

### ● Main Menu

```
+=====+
|      Main Menu      |
+=====+

Web Card Version 01.00.00
MAC Address 00-30-ab-25-e9-1e
[1].User Manager
[2].TCP/IP Setting
[3].Network Parameter
[4].Time Server
[5].Soft Restart
[6].Reset All To Default
[z].Exit Without Save
[0].Save And Exit

Please Enter Your Choice =>
```

## ○ User Manager

```

+=====+
|   User Manager   |
+=====+

RADIUS
[1].RADIUS Auth: Disable
[2].Server:
[3].Secret:
[4].Port:      1812
-----
Local Auth
  Administrator
[5].Account:   admin
[6].Password:  *****
[7].Limitation: Only in This LAN
  Device Manager
[8].Account:   device
[9].Password:  *****
[a].Limitation: Only in This LAN
  Read Only User
[b].Account:   user
[c].Password:  *****
[d].Limitation: Allow Any
[0].Back To Previous Menu

Please Enter Your Choice =>

```

No	Item	Description	Default
[1]	RADIUS Auth	Specify whether RADIUS login is allowed.	Disable
[2]	Server	The RADIUS server name.	
[3]	Secret	The RADIUS secret.	
[4]	Port	The RADIUS port number.	1812
[5]	Administrator Account	The default account/ password for the Administrator (case sensitive).	admin
[6]	Administrator Password		password
[7]	Administrator Limitation	Restrict Administrator login area.	Only in This LAN



No	Item	Description	Default
[8]	Device Manager Account	The default account/ password (case sensitive) for the Device Manager who is only permitted to change device-related settings.	device
[9]	Device Manager Password		password
[a]	Device Limitation	Restrict login area of the Device Manager.	Only in This LAN
[b]	Read Only User Account	The default account/ password (case sensitive) for Read Only User who can only observe settings.	user
[c]	Read Only User Password		password
[d]	Read Only User Limitation	Restrict login area of the Read Only User.	Allow Any

## ● TCP/ IP Configuration

```

+=====+
|   TCP/IP Setting   |
+=====+

[1].IPv4 Address:      192.168.001.100
[2].IPv4 Subnet Mask: 255.255.255.000
[3].IPv4 Gateway IP:  192.168.001.254
[4].IPv4 DNS or WINS IP:192.168.001.001
[5].DHCPv4 Client:    Enable
[6].IPv6 Address:     fe80::230:abff:fe25:900
[7].IPv6 Prefix Length: 64
[8].IPv6 Gateway IP:  ::
[9].IPv6 DNS IP:     ::
[a].DHCPv6:           Enable
[b].Host Name (NetBIOS): INSIGHTPOWER
[c].System Contactor:
[d].System Location:
[e].Auto-Negotiation: Enable
[f].Speed:             100M
[g].Duplex:            Full
[h].Status Stable:    3
[i].Telnet Idle Time: 60 Seconds
[0].Back To Previous Menu

Please Enter Your Choice =>
    
```

<b>No.</b>	<b>Item</b>	<b>Description</b>	<b>Default</b>
[1]	IPv4 Address	The IPv4 address.	192.168.001.100
[2]	IPv4 Subnet Mask	The IPv4 subnet mask setting.	255.255.255.000
[3]	IPv4 Gateway IP	The IPv4 network gateway.	192.168.001.254
[4]	IPv4 DNS or WINS IP	IPv4 Domain Name Server or WINS IP.	192.168.001.001
[5]	DHCPv4 Client	Enable/ disable DHCPv4 protocol.	Enable
[6]	IPv6 Address	The IPv6 address.	
[7]	IPv6 Prefix Length	The IPv6 prefix length.	
[8]	IPv6 Gateway IP	The IPv6 network default gateway.	
[9]	IPv6 DNS IP	IPv6 Domain Name Server IP address.	
[a]	DHCPv6	Enable/ disable DHCPv6 protocol.	Enable
[b]	Host Name (NetBIOS)	The Host Name for the EnviroStation.	INSIGHTPOWER
[c]	System Contactor	The System Contact information.	
[d]	System Location	The System Location information.	
[e]	Auto-Negotiation	Enable/ disable automatic transfer rate (10/ 100M bps) negotiation.	Enable
[f]	Speed	If the Auto-Negotiation is disabled, you can specify the transfer rate.	100M
[g]	Duplex	If the Auto-Negotiation is disabled, you can specify the duplex mode.	Full
[h]	Status Stable	Status change confirmation check time.	3
[i]	Telnet Idle Time	Telnet connection time-out setting.	60 Seconds

## ● Network Parameter

```

+=====+
|   Network Parameter   |
+=====+

[1].HTTP Server:      Enable
[2].HTTPS Server:    Enable
[3].Telnet Server:   Enable
[4].SSH/SFTP Server:  Enable
[5].FTP Server:      Disable
[6].Syslog:          Disable
[7].HTTP Server Port: 80
[8].HTTPS Server Port: 443
[9].Telnet Server Port: 23
[a].SSH Server Port: 22
[b].FTP Server Port: 21
[c].Syslog Server1:
[d].Syslog Server2:
[e].Syslog Server3:
[f].Syslog Server4:
[g].SNMP Get,Set Port: 161
[0].Back To Previous Menu

Please Enter Your Choice =>

```

No.	Item	Description	Default
[1]	HTTP Server	Enable/ disable HTTP protocol.	Enable
[2]	HTTPS Server	Enable/ disable HTTPS protocol.	Enable
[3]	Telnet Server	Enable/ disable Telnet protocol.	Enable
[4]	SSH/ SFTP Server	Enable/ disable SSH/ SFTP protocol.	Enable
[5]	FTP Server	Enable/ disable FTP protocol.	Disable
[6]	Syslog	Enable/ disable remote syslog.	Disable
[7]	HTTP Server Port	HTTP networking port.	80
[8]	HTTPS Server Port	HTTPS networking port.	443

No.	Item	Description	Default
[9]	Telnet Server Port	Telnet networking port.	23
[a]	SSH Server Port	SSH networking port.	22
[b]	FTP Server Port	FTP networking port.	21
[c]	Syslog Server 1	The remote syslog Host Name.	
[d]	Syslog Server 2	The remote syslog Host Name.	
[e]	Syslog Server 3	The remote syslog Host Name.	
[f]	Syslog Server 4	The remote syslog Host Name.	
[g]	SNMP Get, Set Port	The SNMP networking port.	161

## ● Time Server

You can manually adjust time and date for the EnviroStation or set up automatic time server synchronization. The EnviroStation, Windows XP and later versions support SNTP (Simple Network Time Protocol). If you need to start up a time server service on your workstation, please refer to **Chapter 7: Trouble-shooting Q1**.

```

+=====+
|      Time Server      |
+=====+
[1].Time Selection:      SNTP
[2].Time Zone:          +0 hr
[3].1st Time Server:    POOL.NTP.ORG
[4].2nd Time Server:
[5].Manual Date:        01/01/2000 (MM/DD/YYYY)
[6].Manual Time:        00:00:00 (hh:mm:ss)
[0].Back To Previous Menu

Please Enter Your Choice =>

```

No.	Item	Description	Default
[1]	Time Selection	SNTP or manual.	SNTP
[2]	Time Zone	Select the time zone.	+0 hr
[3]	1st Time Server	The first time server for SNTP.	POOL.NTP.ORG
[4]	2nd Time Server	The second time server for SNTP.	
[5]	Manual Date	Set the date manually. (If the Time Selection is set to Manual)	01/01/2000
[6]	Manual Time	Set the date manually. (If the Time Selection is set to Manual)	00:00:00

### ● Soft Restart

Reset the EnviroStation. This will not affect the operation of its connected devices.

### ● Reset All To Default

Reset to manufacture default.

### ● Exit Without Save

Exit and ignore changes.

### ● Save And Exit

Preserve your changes and exit.

## Chapter 5 : InsightPower SNMP IPv6 for EnviroStation Web

To configure EnviroStation via the InsightPower SNMP IPv6 for EnviroStation Web, please follow the steps below:

- Step 1** Make sure that your EnviroStation is connected to the LAN. Use a standard CAT5 cable to connect the EnviroStation's 10/ 100 Base-T Network Port on the rear panel to your network.
- Step 2** Launch your web browser. Enter EnviroStation's Host Name **http://InsightPower** or IP address **http://192.168.1.100/** in the address bar. For encrypted connection, enter **https://InsightPower** or **https://192.168.1.100**.
- Step 3** When connection is established, the EnviroStation Login page appears. Enter your account and password (Default: admin/ password).

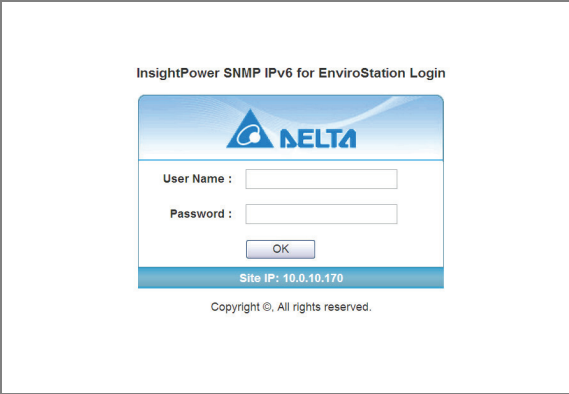

InsightPower SNMP IPv6 for EnviroStation Login



User Name :

Password :

OK

Site IP: 10.0.10.170

Copyright ©. All rights reserved.



### NOTE:

1. If you have previously changed EnviroStation's Host Name or IP address, make sure to provide the correct information accordingly.
2. If the login page is accessible, but you are unable to log in with correct account and password, additional network configuration is needed. The cause could be the IP subnet of the computer you are logging in to is different from the EnviroStation's. To solve this issue, please refer to **Chapter 7: Troubleshooting Q3**.
3. EnviroStation will automatically log off idle connections after 30 minutes.

## 5.1 Monitor

### 5.1.1. Information

This includes the information of System Status, Sensor HUB, Digital Input, Analog Input, Relay Output, Delta Bus, RS485, PDU and IPMI status.

#### ○ Status

This page presents a status overview of connected devices. The values will be updated automatically. To set the refresh period, go to **System Administration** → **Web** → **Web Refresh Period**.

The screenshot displays the 'Status' page of the InsightPower SNMP IPv6 for EnviroStation Web interface. The page is organized into several sections:

- System Status:** Includes Serial # (a0b1b2d3e4f5g), Location, and SNMP Firmware Ver. (01.12.09). It lists protection settings: Internal Communication Error, Short Circuit Protection, Over Current Protection, and Over Voltage Protection.
- Sensor HUB:** Lists 8 sensors: Lock, Beacon, Leakage, Fire-Fault, Fire-Warning, Fire-Alarm, Smoke, and Motion.
- Digital Input:** Lists 4 inputs: Air Conditioning-1 ON, Air Conditioning-1 Trip, Air Conditioning-2 ON, and Air Conditioning-2 Trip.
- Analog Input:** Lists 4 inputs: AI1 Title (0), AI2 Title (0), RTD Sensor (-23.0 C), and Leakage (1022).
- Relay Output:** Lists 2 outputs: DO1 Title (Normal) and DO2 Title (Normal).
- Delta Bus:** Lists 3 IDs: Delta BUS ID0 (Normal), Delta BUS ID1 (Disconnect), and Delta BUS ID2 (Disconnect).
- RS485:** Lists Modbus-1 and Modbus-2.
- PDU:** Lists ID0 (Normal).
- IPMI:** Lists 1 IPMI (Normal) for IBM System x3250 M3.

The interface also features a navigation menu (Monitor, Device, System) and a status bar with 'Home', 'Logout', and 'English' options. The system time is Mon12/24/2012PM01:25:45.

## Delta Bus

Go to **Device** → **Information** → **Delta Bus** to view the status of cascaded EnviroProbes. To add or remove Delta Bus devices, click **Configuration** on the bottom right corner, or go to **Management** → **Delta Bus**.

The screenshot shows the 'Delta Bus' information page in the InsightPower SNMP IPv6 for EnviroStation Web interface. The page is titled 'Monitor » Information » Delta Bus' and features a sidebar with navigation options: Status, Delta Bus (selected), RS485, PDU, and IPMI. The main content area displays three tables representing different EMS devices:

- EMS1000 Table:**

ID	Title	Temperature	Humidity	DI1	DI2	DI3	DI4
0	Delta BUS ID0	26.1 °C	45 %	Security Normal	Leakage Normal	Fire Normal	Smoke Normal
- EMS1100 Table:**

ID	Title	DO1	DO2	DO3	DO4
1	Delta BUS ID1	Relay 1 Normal	Relay 2 Normal	Relay 3 Normal	Relay 4 Normal
- EMS1200 Table:**

ID	Title	AI1	AI2	Leakage	AO
2	Delta BUS ID2	Analog Input 1 0	Analog Input 2 0	Leakage Normal	Analog Output 0

A 'Configuration...' link is visible at the bottom right of the main content area.

## RS485

To check RS485 device parameters, go to **Information** → **RS485**. To add or remove RS485 devices, click **Configuration** on the bottom right corner, or go to **Device** → **Management** → **RS485**.

The screenshot shows the 'RS485' information page in the InsightPower SNMP IPv6 for EnviroStation Web interface. The page is titled 'Monitor » Information » RS485' and features a sidebar with navigation options: Status, Delta Bus, RS485 (selected), PDU, and IPMI. The main content area displays a table for 'Modbus-1 : ID1 - MVCB':

Status
Communication
Value
Frequency: 59.99 Hz
Phase 1 Volt: 13980 V
Phase 2 Volt: 17020 V
Phase 3 Volt: 9760 V
Average Phase Volt: 13580 V
Line 12 Volt: 23000 V
Line 23 Volt: 22900 V
Line 13 Volt: 22960 V

A 'Configuration...' link is visible at the bottom right of the main content area.



## ○ PDU

Go to **Information** → **PDU** to look up a specific PDU's ID No., model No., serial No., hardware version, firmware version, and relevant readings, such as load, frequency, watt & kWh, etc. You can also click the **Data Log** and **Energy Log** buttons (if your web page shows the two buttons) to view more relevant readings. For more information about the data log and energy log, please refer to **5.1.2 History - Event Log** and **5.1.2 History - Energy Log**. If you want to enable a PDU unit, please click Configuration at the right-down corner or go to **Device** → **Management** → **PDU**.

The screenshot displays the web interface for monitoring a PDU. The top navigation bar includes 'Monitor', 'Device', and 'System'. The left sidebar lists 'Status', 'Delta Bus', 'RS485', 'PDU', and 'IPMI'. The main content area shows 'Monitor » Information » PDU' with a dropdown menu for 'ID' set to '0'. Below this, the PDU details are listed: PDU Model: PDU1113, Serial No.: PDU09800001WA, PDU Hardware Ver.: 00, and PDU Firmware Ver.: 01. There are three expandable sections: 'Load & Measurement', 'Watt & kWh', and 'Energy'. Each section contains a table of data.

L1	L2	L3	Total	L1	L2	L3	Frequency
1.1 A	3.2 A	-	4.3 A	121.4 V	120.8 V	-	59.9 Hz

L1	L2	L3	Total
232 Watt	734 Watt	-	966 Watt
153.1 kWh	357.8 kWh	-	510.9 kWh

  

TODAY	MONTH	YEAR
12.8 kWh	334.6 kWh	334.6 kWh

At the bottom right of the main content area, there is a 'Configuration...' link with a gear icon.

## ○ IPMI

Go to **Information** → **IPMI** to look up a server's IPMI information, such as server name, IP address, firmware version, the server's power status and sensor status. To add, remove or configure an IPMI device, click **Configuration** at the right bottom corner, or go to **Device** → **Management** → **IPMI Device**.

The power behind competitiveness
InsightPower SNMP IPv6 for EnviroStation Web
Home Logout English

System Time: Thu 01/01/1970 AM 03:30:13

Monitor Device System

Information History About

Status Delta Bus RS485 PDU **IPMI**

**IPMI**

IPMI Device: 2

Device Name: IBM System x3250 M3

IP Address: 10.0.10.179

Manufacturer ID: 2

Firmware Revision: 1.32

Power State: Power On

**Sensor List**

Sensor	Type	Location	Value	Unit
Planar 3.3V	Voltage	System Board	3.39	Volts
Planar 5V	Voltage	System Board	5.06	Volts
Planar 12V	Voltage	System Board	12.10	Volts
Planar 5V SB	Voltage	System Board	4.95	Volts
CPU VCore	Voltage	System Board	0.86	Volts
Planar VBAT	Voltage	System Board	3.19	Volts
CPU VDIMM	Voltage	System Board	1.48	Volts
PCH 1.05V	Voltage	System Board	1.07	Volts
Ambient Temp	Temperature	System Board	26	degrees C
Fan 1 Tach	Fan	Fan Device	7616	RPM
Fan 2 Tach	Fan	Fan Device	7140	RPM
Fan 3 Tach	Fan	Fan Device	7276	RPM
Fan 4 Tach	Fan	Fan Device	6596	RPM
Fan 5 Tach	Fan	Fan Device	6596	RPM

[Configuration...](#)

## 5.1.2. History

### Event Log

This table lists all occurred event. The existing ones are overwritten when the maximum number of entries (1,000) is reached. You can also download the entire event log archive (event\_log.xls) recorded during an assigned period of time on your computer.

- **Date:** The date when the event occurred.
- **Time:** The time when the event occurred.
- **Level:** The Event Level of the event that occurred.
- **Event Log:** The description of the event that occurred.

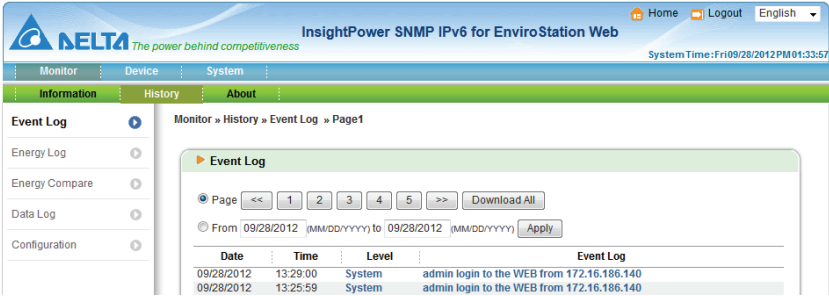

## Energy Log

Go to **Monitor** → **History** → **Energy Log** to look up selected PDUs' energy logs. You can set up a specific time, click the **Display Detail Data** button to view detailed records and click the **Download** button to download the energy logs. The existing records are overwritten when the maximum number of entries (8,000) is reached.

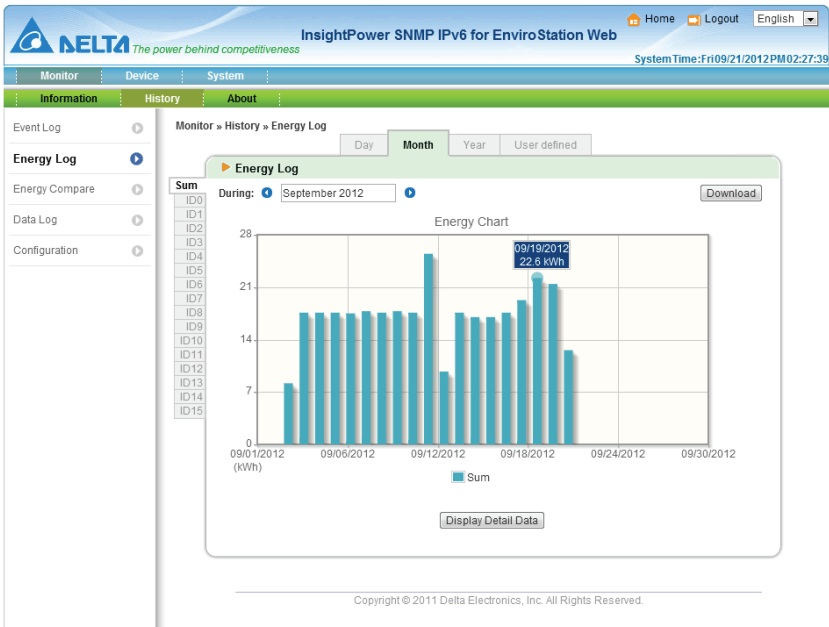

## Energy Compare

Go to **Monitor** → **History** → **Energy Compare** to see any selected two PDUs' energy compare table. Choose any two PDUs' ID No., select a specific time, click the **Apply** button, and an energy compare table appears. You can click the **Display Detail Data** button to view detailed comparison records and click the **Download** button to download comparison logs. The existing records are overwritten when the maximum number of entries (8,000) is reached.

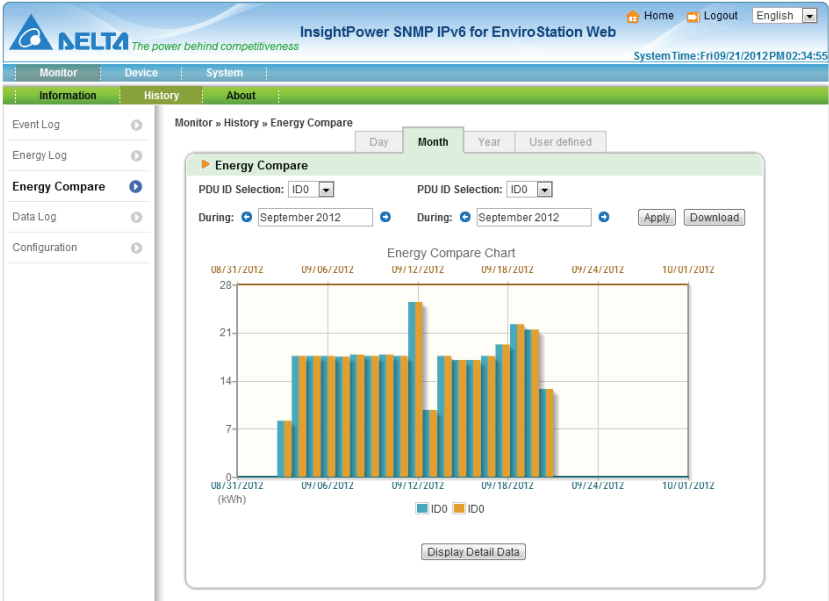

## Data Log

Go to **Monitor** → **History** → **Data Log** to see the analog inputs' data logs, EnviroProbe sensors' data logs and a specific PDU's data log recorded in a specific time. The data log includes information about the selected PDU's total output frequency, total output power, each branch's output voltage, output current and output power. Choose a PDU's ID No., select a specific time, and its data log appears. You can click the **Download** button to download the data log. The existing records are overwritten when the maximum number of entries (8,000) is reached.

The screenshot shows the 'InsightPower SNMP IPv6 for EnviroStation Web' interface. The top navigation bar includes 'Home', 'Logout', and 'English'. Below the navigation bar, there are tabs for 'Monitor', 'Device', and 'System'. The 'Monitor' tab is active, and the 'History' sub-tab is selected. The 'Data Log' section is expanded, showing a list of data log entries for various PDU units (PDU0 to PDU15) over time. The data log table includes columns for Date, Time, AI1 AI1 Title, AI2 AI2 Title, AI3 RTD Sensor, AI4 Leakage, Delta\_Bus\_ID0, Delta\_Bus\_ID1, and Delta\_B\_Hum. The table shows multiple rows of data for each PDU unit, with columns for Lo and Hi values for each parameter.

Sys	Date	Time	AI1 AI1 Title		AI2 AI2 Title		AI3 RTD Sensor		AI4 Leakage		Delta_Bus_ID0		Delta_B_Hum
			Lo	Hi	Lo	Hi	Lo	Hi	Lo	Hi	Lo	Hi	Lo
PDU0	09/21/2012	14:30:15	0.0	4.0	0.0	2.0	-23.2C	-22.2C	979.0	984.0	27.6C	27.9C	45%
PDU1	09/21/2012	14:20:15	0.0	4.0	0.0	2.0	-23.2C	-22.1C	980.0	985.0	27.5C	27.9C	44%
PDU2	09/21/2012	14:10:10	0.0	3.0	0.0	3.0	-23.2C	-22.0C	981.0	984.0	27.7C	28.0C	44%
PDU3	09/21/2012	14:00:09	0.0	4.0	0.0	2.0	-23.2C	-22.0C	979.0	984.0	27.8C	28.0C	44%
PDU4	09/21/2012	13:50:09	0.0	3.0	0.0	2.0	-23.2C	-21.7C	978.0	985.0	27.6C	27.9C	45%
PDU5	09/21/2012	13:40:09	0.0	3.0	0.0	3.0	-23.2C	-21.9C	980.0	985.0	27.6C	27.9C	44%
PDU6	09/21/2012	13:30:09	0.0	3.0	0.0	2.0	-23.2C	-21.5C	980.0	984.0	27.8C	28.1C	44%
PDU7	09/21/2012	13:20:09	0.0	3.0	0.0	10.0	-23.2C	-22.1C	968.0	985.0	27.9C	28.1C	44%
PDU8	09/21/2012	13:10:09	0.0	2.0	0.0	3.0	-23.2C	-22.0C	981.0	985.0	27.9C	28.1C	44%
PDU9	09/21/2012	13:00:05	0.0	3.0	0.0	2.0	-23.2C	-22.0C	979.0	985.0	27.7C	27.9C	44%
PDU10	09/21/2012	12:50:05	0.0	3.0	0.0	2.0	-23.2C	-22.2C	980.0	984.0	27.5C	27.9C	45%
PDU11	09/21/2012	12:40:05	0.0	3.0	0.0	3.0	-23.2C	-21.9C	981.0	984.0	27.5C	27.8C	44%
PDU12	09/21/2012	12:30:05	0.0	3.0	0.0	2.0	-23.2C	-22.0C	980.0	985.0	27.5C	27.9C	44%
PDU13	09/21/2012	12:20:05	1.0	11.0	0.0	2.0	-23.2C	-22.1C	981.0	985.0	27.7C	28.0C	45%
PDU14	09/21/2012	12:10:05	0.0	3.0	0.0	2.0	-23.2C	-22.0C	980.0	984.0	27.7C	27.9C	45%
PDU15	09/21/2012	12:00:05	1.0	3.0	0.0	2.0	-23.2C	-22.1C	979.0	985.0	27.6C	27.8C	45%
	09/21/2012	11:50:00	0.0	3.0	0.0	2.0	-23.2C	-22.2C	981.0	985.0	27.5C	27.9C	44%
	09/21/2012	11:40:00	1.0	3.0	0.0	2.0	-23.2C	-22.1C	872.0	984.0	27.9C	28.1C	45%
	09/21/2012	11:30:00	1.0	3.0	0.0	3.0	-23.2C	-21.9C	980.0	984.0	27.8C	28.1C	45%
	09/21/2012	11:20:00	1.0	6.0	0.0	2.0	-23.2C	-22.2C	980.0	984.0	27.7C	28.0C	45%
	09/21/2012	11:10:00	1.0	3.0	0.0	4.0	-23.2C	-22.1C	980.0	984.0	27.5C	27.8C	46%
	09/21/2012	11:00:00	0.0	8.0	0.0	3.0	-23.2C	-22.0C	973.0	984.0	27.5C	27.8C	45%
	09/21/2012	10:50:00	1.0	7.0	0.0	3.0	-23.2C	-22.2C	979.0	985.0	27.5C	27.9C	45%
	09/21/2012	10:39:55	0.0	6.0	0.0	5.0	-23.2C	-22.1C	980.0	985.0	27.7C	27.9C	45%
	09/21/2012	10:29:55	0.0	3.0	0.0	2.0	-23.2C	-22.3C	979.0	984.0	27.5C	27.9C	46%
	09/21/2012	10:19:55	1.0	24.0	0.0	9.0	-23.2C	-22.0C	981.0	984.0	27.3C	27.8C	47%
	09/21/2012	10:09:55	1.0	6.0	0.0	2.0	-23.2C	-22.1C	981.0	990.0	27.1C	27.5C	46%
	09/21/2012	09:59:55	0.0	7.0	0.0	2.0	-23.2C	-21.7C	980.0	984.0	27.1C	27.4C	46%
	09/21/2012	09:49:55	1.0	4.0	0.0	2.0	-23.1C	-21.9C	980.0	984.0	27.2C	27.7C	46%
	09/21/2012	09:39:55	1.0	3.0	0.0	22.0	-23.2C	-21.9C	971.0	984.0	27.4C	27.8C	47%

## ● Configuration

Go to **Monitor** → **History** → **Configuration** to clear the event log, energy log, energy compare log, and data log. You can also assign **Save Data Interval** and **Save Energy Interval**.

- **Clear History Data:** Empty the data log only.
- **Clear Event Log:** Empty the event log only.
- **Clear Energy Data:** Empty the energy log and energy compare log.
- **Save Data Interval:** The time interval after which a data entry is recorded.
- **Save Energy Interval:** The time interval after which an energy/ energy compare entry is recorded.

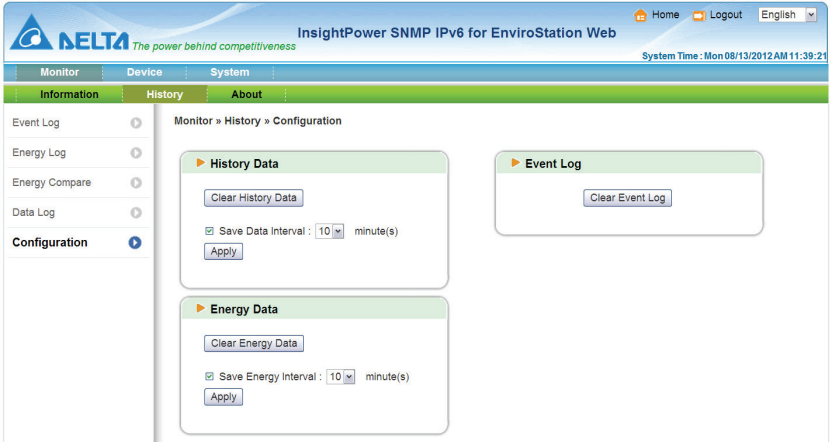

### 5.1.3. About

#### ● Information

Go to **Monitor** → **About** → **Information** to see the version of your InsightPower SNMP IPv6 for EnviroStation and other information about OpenSSL toolkit and license.

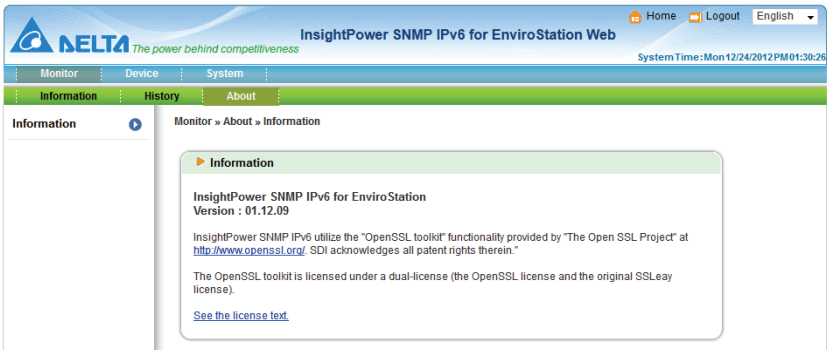

## 5.2 Device

### 5.2.1. Management

The InsightPower SNMP IPv6 for EnviroStation Web allows detailed configurations for Sensor HUB, Digital Input, Analog Input, Relay Output, Delta Bus, RS485, Protocol, PDU, IPMI Device, IPMI Template and Reaction.

#### ● Sensor HUB

The screenshot shows the web interface for configuring a Sensor HUB. The page title is "InsightPower SNMP IPv6 for EnviroStation Web". The navigation menu includes "Monitor", "Device", and "System". The "Management" section is active, and the "Sensor HUB" configuration page is displayed. The interface is divided into two main sections: "Sensor HUB" and "Power Configuration".

**Sensor HUB Configuration Table:**

	NO/NC	Event Type	Title
1	Normal Open	Warning	Lock
2	Normal Open	Warning	Beacon
3	Normal Open	Warning	Leakage
4	Normal Open	Warning	Fire-Fault
5	Normal Open	Warning	Fire-Warning
6	Normal Open	Warning	Fire-Alarm
7	Normal Open	Warning	Smoke
8	Normal Open	Warning	Motion

**Power Configuration Table:**

	Mode	Active Period	Operation	Control
1	Normal On	10 Sec	Automatic	On Off
2	Normal Off	5 Sec	Automatic	On Off

Additional options include "Description..." and "Status..." checkboxes, and a "Submit" button at the bottom.

- **NO/ NC:** Stands for Normal Open and Normal Close. If Normal Open is selected, an event is triggered when 1. Dry Contact is closed or 2. Wet Contact is provided with 5~24Vdc. If Normal Close is selected, an event is triggered when 1. Dry Contact is open, or 2. Wet Contact is provided with <1.5Vdc. Please see the following table:

Digital Value	Dry Contact	Wet Contact
1	Close	5~24Vdc
0	Open	< 1.5Vdc

- **Event Type:** Allows you to individually determine sensor alarm levels. Reactions will only be triggered when Warning or Alarm is selected.
- **Title:** You can entitle devices for identification.
- **Power Configuration:** If **Normal Open** is selected, the EnviroStation supplies 12Vdc or 24Vdc power to Sensor HUB. If **Manual** is selected and **Off** button is clicked, the power is cut off. You can also set up **Reaction** (please see **5-2-1 Management- Reaction**) to automatically cut off the power. Power is cut off during the period of time specified in the **Active Period** box. Power resumes after the given duration. If the specified **Active Period** is 0, power does not resume.

## ○ Digital Input

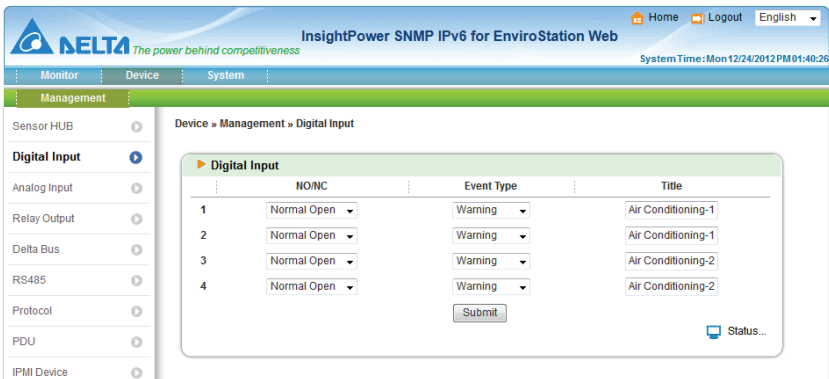

- **NO/ NC:** If Normal Open is selected, an event is triggered when 1. Dry Contact is closed, or 2. Wet Contact is provided with 5~24Vdc. If Normal Close is selected, an event is triggered when 1. Dry Contact is open, or 2. Wet Contact is provided with < 1.5Vdc.

Digital Value	Dry Contact	Wet Contact
1	Close	5~24Vdc
0	Open	< 1.5Vdc

- **Event Type:** Allows you to individually determine the Alarm levels for sensors. Selecting Alarm or Warning triggers reactions.
- **Title:** You can entitle devices for identification.



## ● Analog Input

- **Formula:** AI (Analog Input) 1 and AI2 are designed for general Analog In-puts, each can be connected to a voltage (0~10Vdc) or current (0~20mA) source. EnviroStation translates the ADC (Analog-to-digital converter) values according to the following formula:  $(ADC-a)*b/c-d$ . You can select the unit scale and define the unit string for the translated values.
- **Title:** You can entitle devices for identification.
- **Warning / Alarm:** You can set event type to Warning or Alarm.
- **RTD:** The AI3 is designed to connect an RTD device. You can define the conditions when reactions are triggered for Warning and Alarm levels.
- **Leakage:** The AI4 is designed to connect a leakage sensor. You can select the sensor sensitivity and Event Type.

The screenshot shows the 'Analog Input' configuration page in the EnviroStation Web interface. The page is titled 'Device » Management » Analog Input'. It features a navigation menu on the left with options like 'Sensor HUB', 'Digital Input', 'Analog Input', 'Relay Output', 'Delta Bus', 'RS485', 'Protocol', 'PDU', 'IPMI Device', 'IPMI Template', and 'Reaction'. The main configuration area is divided into three sections: 'Analog Input', 'RTD', and 'Leakage'.

	(ADC-a)*b/c-d	Title	Warning (or)	Alarm (or)
1	a= 0 b= 1 c= 1 d= 0	AI1 Title Unit: 1	< 0 < 0	< 0 < 0
2	a= 0 b= 1 c= 1 d= 0	AI2 Title Unit: 1	< 0 < 0	< 0 < 0
RTD		Title	Warning (or)	Alarm (or)
3	Sensor Type: PT100	RTD Sensor Unit: 1/10 C	< -100 < -100	< -100 < -100
Leakage		Title	Event Type	
4	Sensitivity: Middle	Leakage	None	

At the bottom of the configuration area, there is a 'Submit' button and a 'Status...' link.

## ● Relay Output

The screenshot shows the Delta InsightPower SNMP IPv6 for EnviroStation Web interface. The top navigation bar includes 'Home', 'Logout', and 'English'. The main menu has 'Monitor', 'Device', and 'System'. The 'Management' section is active, showing a sidebar with 'Sensor HUB', 'Digital Input', 'Analog Input', 'Relay Output' (selected), 'Delta Bus', 'RS485', and 'Protocol'. The main content area is titled 'Device » Management » Relay Output' and contains a 'Relay Output' configuration table with columns for 'Operation', 'Period', 'Control', and 'Title'. Two rows are visible, both with 'Automatic' operation and '0 Sec' period. The 'Control' column has 'Normal' and 'Alarm' buttons. The 'Title' column has input fields for 'DO1 Title1' and 'DO2 Title2'. A 'Submit' button and 'Description...' and 'Status...' links are at the bottom.

- **Operation:** Select **Automatic** to enable automatic linking between a specific relay output and **Reaction** (please see **5.2.1 Management - Reaction**). Select **Manual** to set the specific relay output status by clicking the **Normal** and **Alarm** buttons.
- **Period:** The relay output changes its status during the period of time specified in the **Period** box. The original relay output status resumes after the given duration. If the specified **Period** is 0, the original relay output status does not resume automatically unless you manually click the **Normal** button or set up **Reaction** (please see **5.2.1 Management - Reaction**).
- **Title:** You can entitle devices for identification.

## ● Delta Bus

The EnviroStation communicates with EnviroProbes through the Delta Bus. There are three types of EnviroProbes, (1) EnviroProbe (EMS1000), (2) EnviroProbe 1100 (EMS1100) and (3) EnviroProbe 1200 (EMS1200). The Delta Bus page varies according to different types of EnviroProbes. Please see below:

- **For EnviroProbe (EMS1000):**

The EnviroProbe (EMS1000) provides one temperature/ humidity sensor and four digital outputs. In this page, select an **ID** first and then set up **Title** and **Type**. Click **Enable** if you wish to enable the device. Please note that the **ID** means the ID No. you set up for your EnviroProbe (EMS1000) using its ID DIP switches (please see **3.3 EnviroProbe**). You can set up **Warning** and **Alarm** conditions for the temperature/ humidity sensor, and define each input contact's **NO/ NC**, **Title** and **Event Type**.

EnviroProbe Configuration			
ID	Title	Type	Enable
ID 0	Delta BUS ID0	EMS1000	<input checked="" type="checkbox"/>
<b>Warning</b>		<b>Alarm</b>	
Temperature	Warning: > 30 °C	Alarm: > 40 °C	
	Recovery: < 28 °C	Recovery: < 38 °C	
Humidity	Warning: > 80 %	Alarm: > 90 %	
	Recovery: < 70 %	Recovery: < 80 %	
	<b>NO/NC</b>	<b>Title</b>	<b>Event Type</b>
Input Contact1:	Normal Open	Security	Warning
Input Contact2:	Normal Open	Leakage	Warning
Input Contact3:	Normal Open	Fire	Warning
Input Contact4:	Normal Open	Smoke	Warning
<input type="button" value="Submit"/>			

- **For EnviroProbe 1100 (EMS1100)**

The EnviroProbe 1100 (EMS1100) provides four digital outputs. In this page, select an **ID** first and then set up **Title** and **Type**. Click **Enable** if you wish to enable the device. Please note that the **ID** means the ID No. you set up for your EnviroProbe 1100 (EMS1100) using its ID DIP switches (please see **3.3 EnviroProbe**). You can set up each digital output's **Operation**, **Period** and **Title**. Select **Automatic** to enable automatic linking between a specific digital output and **Reaction** (please see **5.2.1 Management - Reaction**). Select **Manual** to set the specific digital output status by clicking the **Normal** and **Alarm** buttons.

The digital output changes its status during the period of time specified in the **Period** box. The original digital status resumes after the given duration. If the specified **Period** is 0, the original digital status does not resume automatically unless you manually click the **Normal** button or set up **Reaction** (please see **5.2.1 Management - Reaction**).

**EnviroProbe Configuration**

ID	Title	Type	Enable
ID 0	Delta BUS ID0	EMS1100	<input checked="" type="checkbox"/>

	Operation	Period	Control	Title
1	Automatic	0 Sec	Normal Alarm	Relay 1
2	Automatic	0 Sec	Normal Alarm	Relay 2
3	Automatic	0 Sec	Normal Alarm	Relay 3
4	Automatic	0 Sec	Normal Alarm	Relay 4

- **For EnviroProbe 1200 (EMS1200)**

The EnviroProbe 1200 (EMS1200) provides two analog inputs, one analog output and one water-leakage detection. In this page, select an **ID** first and then set up **Title** and **Type**. Click **Enable** if you wish to enable the device. Please note that the **ID** means the ID No. you set up for your EnviroProbe 1200 (EMS1200) using its ID DIP switches (please see **3.3 EnviroProbe**). You can set up the following:

- 1) Analog Input**

Set up each analog input's **((ADC-a)\*b/c-d)**, **Title** and **Event Settings**. Click the color bar in **Event Settings** to change event types for different thresholds of analog inputs. Green, yellow, and red mean normal, warning, and alarm events respectively.

- 2) Leakage**

Set up leakage's **Sensitivity**, **Title** and **Event Type**. If you check the **Buzzer Enable** box, the EnviroProbe 1200 (EMS1200) will enable buzzer when it detects water leakage.

- 3) Analog Output**

Set up analog output (**Automatic** or **Manual**), **Title** and **Control**. If **Manual** is selected, **Reaction** (please see **5.2.1 Management - Reaction**) won't be able to control analog output.

**EnviroProbe Configuration**

ID	Title	Type	Enable
ID 0	Delta BUS ID0	EMS1200	<input checked="" type="checkbox"/>

(ADC-a)*b/c-d	Title	Event Settings			
1 a=0 b=1 c=1 d=0	Analog Input 1 Unit: 1	0	0	0	0
2 a=0 b=1 c=1 d=0	Analog Input 2 Unit: 1	0	0	0	0

Leakage	Title	Event Type	Buzzer Enable
3 Sensitivity: Middle	Leakage	Warning	<input type="checkbox"/>

Analog Output	Title	Control
4 Automatic	Analog Output	0

## RS485

**DELTA** The power behind competitiveness  
InsightPower SNMP IPv6 for EnviroStation Web  
Home Logout English  
System Time: Mon 12/24/2012 PM 02:23:33

Monitor Device System

Management

Sensor HUB  
Digital Input  
Analog Input  
Relay Output  
Delta Bus  
**RS485**  
Protocol  
PDU  
IPMI Device

Device » Management » RS485

**RS485**

Modbus-1				Modbus-2				
Baud Rate:	9600	Data Bits:	8	Baud Rate:	9600	Data Bits:	8	
Parity Check:	None	Stop Bit:	1	Parity Check:	None	Stop Bit:	1	
ID	Protocol	Title	ID	Protocol	Title	ID	Protocol	Title
1 0	None		1 0	None		2 0	None	
2 0	None		2 0	None		3 0	None	
3 0	None		3 0	None		4 0	None	
4 0	None		4 0	None				

There are two RS485 ports on the rear panel, each port can be configured with a different baud rate, data bits, parity and stop bit. EnviroStation communicates with up to 16 Modbus devices in an RS485 port. You can individually select protocol for each Modbus device from the dropdown menu.

If a suitable protocol cannot be found, you can manually define a special Mod-bus protocol. Please see **5.2.1 Management - Protocol**.

## Protocol

In this page, you can add, modify or delete protocols. You can also export or import protocols from files for backup purposes. Each protocol contains 32 values and 32 statuses.

The screenshot shows the 'Protocol' management page in the InsightPower SNMP IP6 for EnviroStation Web interface. The page is titled 'Device » Management » Protocol'.

**Protocol List:**

- UPS-Delta-1P
- Meter-MGE-PM710MG
- Meter-AXE-MMP-2
- Sensor-Delta-EnviroProbe
- Meter-S2-800WH
- CPM-50

**Protocol Name:** UPS-Delta-1P

**Buttons:** Add, Modify, Delete, Export, Import

**Value Table:**

Description	Function Code	Real Address	Type	Unit	
1	Input Frequency	0x04: Input	1073	Word(+)	0.1 Hz
2	Input Voltage	0x04: Input	1074	Word(+)	0.1 V
3	Input Current	0x04: Input	1075	Word(+)	0.1 A
4	Input Power	0x04: Input	1076	Word(+)	10 W
5	Output Frequency	0x04: Input	1091	Word(+)	0.1 Hz
6	Output Voltage	0x04: Input	1093	Word(+)	0.1 V
7	Output Current	0x04: Input	1094	Word(+)	0.1 A
8	Output Power	0x04: Input	1095	Word(+)	10 W
9	Output Load	0x04: Input	1096	Word(+)	1 %

**Status Table:**

Description	Function Code	Real Address	Bit Mask (Hex)	Warning (or)	Alarm (or)	
1	Over Temperature	2: Discrete	256	FFFF	< 0	> 0
2	Input Power Abnormal	2: Discrete	257	FFFF	> 0	< 0
3	Overload	2: Discrete	259	FFFF	< 0	> 0
4	Output Off	2: Discrete	261	FFFF	< 0	> 0
5	UPS Shutdown	2: Discrete	262	FFFF	< 0	> 0

**Writable Value Table:**

Description	Function Code	Type	Real Address
1	None	Byte(+): Lo	0
2	None	Byte(+): Lo	0
3	None	Byte(+): Lo	0
4	None	Byte(+): Lo	0
5	None	Byte(+): Lo	0
6	None	Byte(+): Lo	0
7	None	Byte(+): Lo	0
8	None	Byte(+): Lo	0
9	None	Byte(+): Lo	0

**Footer:** Configure RS485...

## ● PDU

After you check the **PDU Enable** box to enable monitoring PDU feature, please use the provided RJ45-DB9 cable to connect the EnviroStation and your PDU. Connect the RJ45 to the EnviroStation's console port and connect the DB9 to the PDU's RS232-2 port. For installation information, please refer to **3.9 PDU Installation**. Please note that, once you check the **PDU Enable** box, the text mode will be disabled. After you select PDU ID No. and click Submit, the EnviroStation will monitor the PDU units accordingly.

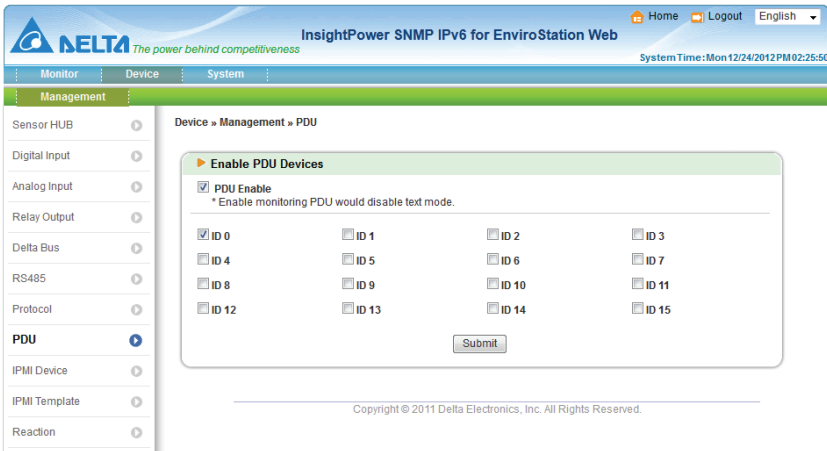

## ● IPMI Device

### ● IPMI Scan Setting

You can set up **IPMI Scan Interval** here. After setup, all IPMI devices will be scanned when the scan time is due.

### ● IPMI Device List

You can enter the **Device Name**, **Username**, **Password**, **IP Address**, **IPMI Version**, **Cipher Suite** and **IPMI Template** in this page. Click **Add**, **Update** or **Delete** to add, modify or delete an IPMI device's configuration. You can also add an IPMI device if you enter **Username**, **Password**, **IP Address**, **IPMI Version**, **Cipher Suite** and click the **Scan** button.

**IPMI Scan Setting**

IPMI Scan Interval :  minute(s)

---

**IPMI Device List**

Device Name	Username	Password	IP Address	Version	Cipher Suite	Template
<input type="text"/>	USERID	*****	10.0.10.178 ~ 179	2.0	1	None

**Scanning...**



---

Device Name	Username	Password	IP Address	Version	Cipher Suite	Template
-------------	----------	----------	------------	---------	--------------	----------

Device scan result will appear after the scan process is done. You can add a device that you would like to monitor if you check the **Add** box, give a device name, specify its template, and then click the **Add** button.

**IPMI Scan Setting**

IPMI Scan Interval :  minute(s)

---

**IPMI Device List**

Device Name	Username	Password	IP Address	Version	Cipher Suite	Template
<input type="text"/>	USERID	*****	10.0.10.178 ~ 179	2.0	1	None

**Found Device 1**

Add	Device Name	Username	Password	IP Address	Version	Cipher Suite	Template
<input type="checkbox"/>	10.0.10.179	USERID	*****	10.0.10.179	2.0	1	None

---

Device Name	Username	Password	IP Address	Version	Cipher Suite	Template	
1	HP ProLiant DL380 G7	Administrator	*****	10.0.10.178	2.0	1	HP ProLiant DL380 G7



## ● IPMI Template

You can add and delete an IPMI template in this page. You can also modify the IPMI template to decide how many sensors that you want to monitor.

### ● Template Scan

To scan an IPMI template, you have to enter the **Username**, **Password**, server's **IP Address**, **IPMI version** and **Cipher Suite**. After clicking the **Scan** button, the system will start the template scan.

**Template Scan**

Username	Password	IP Address	Version	Cipher Suite
<input type="text" value="USERID"/>	<input type="password" value="*****"/>	<input type="text" value="10.0.10.179"/>	<input type="text" value="2.0"/>	<input type="text" value="1"/>

Scanning...

After scanning, all sensors will be shown in this page. You can specify the template name and click the **New** button to create a new IPMI template.

**Template Scan**

Username	Password	IP Address	Version	Cipher Suite
<input type="text" value="USERID"/>	<input type="password" value="*****"/>	<input type="text" value="10.0.10.179"/>	<input type="text" value="2.0"/>	<input type="text" value="1"/>

Template Name :

	Sensor	Type	Location	Enable	UNR	UC	UNC	LNC	LC	LNR
1	Planar 3.3V	Voltage	System Board	Volts	-	3.62	-	-	2.96	-
2	Planar 5V	Voltage	System Board	Volts	-	5.49	-	-	4.49	-
3	Planar 12V	Voltage	System Board	Volts	-	13.18	-	-	10.80	-
4	Planar 5V SB	Voltage	System Board	Volts	-	5.49	-	-	4.49	-
5	CPU VCore	Voltage	System Board	Volts	-	-	-	-	-	-
6	Planar VBAT	Voltage	System Board	Volts	-	-	-	2.38	2.24	-
7	CPU VDIMM	Voltage	System Board	Volts	-	1.65	-	-	1.35	-
8	PCH 1.05V	Voltage	System Board	Volts	-	1.16	-	-	0.94	-
9	Ambient Temp	Temperature	System Board	degrees C	47	43	40	-	-	-
10	Fan 1 Tach	Fan	Fan Device	RPM	-	-	-	-	1020	-
11	Fan 2 Tach	Fan	Fan Device	RPM	-	-	-	-	1020	-
12	Fan 3 Tach	Fan	Fan Device	RPM	-	-	-	-	1020	-
13	Fan 4 Tach	Fan	Fan Device	RPM	-	-	-	-	1020	-
14	Fan 5 Tach	Fan	Fan Device	RPM	-	-	-	-	1020	-

## ● Template

A new template will be shown on the template list after you click the **New** button. All sensors belonged to the new template are disabled (default). You can enable a specific sensor by checking its **Enable** box. You can also enable several sensors that you like and group them into a new template by giving a new template name in the **Template Name** column. After clicking the **Add** button, the new template name will be added into the template list. You can also **Modify** or **Delete** a template name. To export a template file, please click the **Export** button and save the file as a new file. To import a template file, click the **Browse** button, find the specific template file, and then click the **Import** button to import the IPMI template file.

The screenshot displays the 'IPMI Template' management interface. On the left, a sidebar lists various sensor categories, with 'IPMI Template' selected. The main content area is titled 'Device » Management » IPMI Template' and contains two primary sections: 'Template Scan' and 'Template'.

The 'Template Scan' section includes a form with fields for Username, Password, IP Address, Version (set to 2.0), and Cipher Suite (set to 1), along with a 'Scan' button.

The 'Template' section features a 'Template List' dropdown menu showing 'HP ProLiant DL380 G7' and 'IBM System x3250 M3'. Below this is a 'Template Name' input field containing 'IBM System x3250 M3', with 'Add', 'Modify', and 'Delete' buttons. To the right, there are 'Export' and 'Import' buttons with descriptive text: 'Export to download the template file.' and 'Import to REPLACE the selected template.'

At the bottom, a table displays the status of various sensors. The table has columns for Sensor, Type, Location, Unit, Enable, UNR, UC, UNC, LNC, LC, and LNR.

Sensor	Type	Location	Unit	Enable	UNR	UC	UNC	LNC	LC	LNR
1 Planar 3.3V	Voltage	System Board	Volts	<input checked="" type="checkbox"/>	-	3.62	-	-	2.96	-
2 Planar 5V	Voltage	System Board	Volts	<input checked="" type="checkbox"/>	-	5.49	-	-	4.49	-
3 Planar 12V	Voltage	System Board	Volts	<input checked="" type="checkbox"/>	-	13.18	-	-	10.80	-
4 Planar 5V SB	Voltage	System Board	Volts	<input checked="" type="checkbox"/>	-	5.49	-	-	4.49	-
5 CPU VCore	Voltage	System Board	Volts	<input checked="" type="checkbox"/>	-	-	-	-	-	-
6 Planar VBAT	Voltage	System Board	Volts	<input checked="" type="checkbox"/>	-	-	-	2.38	2.24	-
7 CPU VDIMM	Voltage	System Board	Volts	<input checked="" type="checkbox"/>	-	1.65	-	-	1.35	-
8 PCH 1.05V	Voltage	System Board	Volts	<input checked="" type="checkbox"/>	-	1.16	-	-	0.94	-
9 Ambient Temp	Temperature	System Board	degrees C	<input checked="" type="checkbox"/>	47	43	40	-	-	-
10 Fan 1 Tach	Fan	Fan Device	RPM	<input checked="" type="checkbox"/>	-	-	-	-	1020	-
11 Fan 2 Tach	Fan	Fan Device	RPM	<input checked="" type="checkbox"/>	-	-	-	-	1020	-
12 Fan 3 Tach	Fan	Fan Device	RPM	<input checked="" type="checkbox"/>	-	-	-	-	1020	-

## Reaction

User can add (click +), modify and delete (click -) reaction items in this page. Click **Edit** to setup **Reaction Rule**. EnviroStation supports up to 64 reaction items.

ID	Name	Enable
-	Reaction Sample	<input type="checkbox"/>
-	Recover Sample	<input type="checkbox"/>
+      Edit...      Edit...		
Submit		

**Reaction Rule** includes settings of **Weekday**, **Time**, **Condition** and **Output**. When each situation/ condition is met, corresponding outputs will be enabled.

1. **Weekday & Time:** Set up time.
2. **Period:** After setting up the **Period**, the EnviroStation will regularly execute the **Reaction Rule**. If the **Reaction Rule**'s all conditions are met, there will be corresponding outputs. If the **Period** is 0 and the **Reaction Rule**'s all conditions are met for the 1st time, corresponding outputs will occur. However, after the 2<sup>nd</sup> time (included), there will be no corresponding outputs.
3. **Condition:** Set up **Device**, **ID**, **Type**, **Port**, **Operation** and **Value**. Click + or - to add or delete a condition. You can set up at maximum 16 conditions.
4. **Output:** Set up **Device**, **ID**, **Port** and **Value**. Click + or - to add or delete an output. You can set up at maximum 16 outputs.

**Reaction Rule**

**Reaction Sample**

**Weekday**  Sun  Mon  Tue  Wed  Thu  Fri  Sat

**Time**  All Day Start 0 : 0 End 23 : 59

**Period** 0 Seconds (0 for disable)

**Condition**

&	Device	ID	Type	Port	Operation	Value
-	EMS2000	0	Event	DI1 (Air Conditioning-1 ON)	==	Alarm
+						

**Output**

&	Device	ID	Port	Value
-	EMS2000	0	DO1 (DO1 Title)	Alarm
+				

Submit Close

## 5.3 System

### 5.3.1. Administration

#### ○ User Manager

The EnviroStation supports RADIUS. Check the **Use RADIUS** box, key in required information including Server, Secret and Port (default: 1812) and click **submit** to enable RADIUS. You can define service types for Administrator, De-vice Manager and Read Only User. If RADIUS is disabled, you can still manage the Account Name, Password and Login Limitation for Local Authentication.

The screenshot displays the 'User Manager' configuration page in the EnviroStation web interface. The page is titled 'System » Administration » User Manager'. The main content area is divided into several sections:

- User Manager** (Header)
- Use RADIUS** (Section): A checkbox labeled 'Use RADIUS' is present. Below it are three input fields: 'Server (51 chars max.)', 'Secret (32 chars max.)', and 'Port' (with the value '1812' entered).
- RFC2865 Service Type:** A table with three columns: 'Administrator', 'Device Manager', and 'Read Only User'. Each column contains a list of checkboxes for various service types, including 'Login User', 'Framed User', 'Callback Login', 'Callback Framed', 'Outbound', 'Administrative', 'NAS Prompt', 'Authenticate Only', 'Callback NAS Prompt', 'Call Check', and 'Callback Administrative'.
- Local Authentication:** A table with four columns: 'Privilege', 'Account Name (16 chars max.)', 'Password (16 chars max.)', and 'Login Limitation'. The rows are for 'Administrator', 'Device Manager', and 'Read Only User'. The 'Account Name' and 'Password' fields are filled with 'admin', 'device', and 'user' respectively. The 'Login Limitation' column has radio buttons for 'Only in This LAN' and 'Allow Any'.
- Submit** (Button): A button at the bottom right of the Local Authentication section.

The left sidebar contains a navigation menu with items: TCP/IP, Web, Console, FTP, Time Server, Syslog, Batch Configuration, and Upgrade. The top navigation bar includes 'Monitor', 'Device', and 'System' tabs, along with 'Home', 'Logout', and 'English' options. The system time is shown as 'Mon 08/13/2012 AM 11:42:37'.

## ● TCP/ IP

Set IPv4 and IPv6 addresses and fill in system information in this page. Please refer to the descriptions below.

The screenshot displays the configuration interface for the EnviroStation Web. The top navigation bar includes 'Monitor', 'Device', and 'System' tabs. The left sidebar lists various system management options, with 'TCP/IP' selected. The main content area is divided into two panels: 'TCP/IP Settings for IPv4' and 'System'. The IPv4 settings panel contains fields for DHCP Client, IP Address, Subnet Mask, Gateway IP, DNS IP, and Search Domain. The System panel contains fields for Host Name, System Contactor, System Location, and Link settings (Auto-Negotiation, Speed, Duplex). A 'Submit' button is located at the bottom of the System panel.

### ● IPv4 (TCP/ IP Settings for IPv4)

- 1) **DHCP Client:** Enable/ disable DHCP. If enabled, DHCP server automatically assigns an IP address to the EnviroStation.
- 2) **IP Address:** The IP address in dotted format (e.g. 192.168.1.100).
- 3) **Subnet Mask:** The Subnet Mask for your network (e.g. 255.255.255.0).
- 4) **Gateway IP:** The IP address for network gateway in dotted format (e.g. 192.168.1.254).
- 5) **DNS IP:** The IP address Domain Name Server in dotted format (e.g. 192.168.1.1).
- 6) **Search Domain:** If the Host Name you provided cannot be found, the system appends the search domain to your Host Name.

- **IPv6 (TCP/ IP Settings for IPv6)**

- 1) **DHCP Client:** Enable/ disable DHCP. If enabled, DHCP server automatically assigns an IP address to the EnviroStation.
- 2) **IP Address:** The IPv6 address.
- 3) **Prefix Length:** The prefix length for the IPv6 address.
- 4) **Gateway V6IP:** The IP address for the IPv6 network gateway.
- 5) **DNS V6IP:** The IP address for the IPv6 domain name server.

- **System**

- 1) **Host Name:** The SNMP Host Name on the network.
- 2) **System Contactor:** System contact information .
- 3) **System Location:** System location information.

- **Link**

- 1) **Auto-Negotiation:** Enable/ disable automatic transfer rate (10/ 100M bps) negotiation.
- 2) **Speed:** If Auto-Negotiation is disabled, you can specify the transfer rate.
- 3) **Duplex:** If Auto-Negotiation is disabled, you can specify the duplex mode.

- **Web**

This allows Administrator to enable/ disable HTTP/ HTTPS communication protocols.

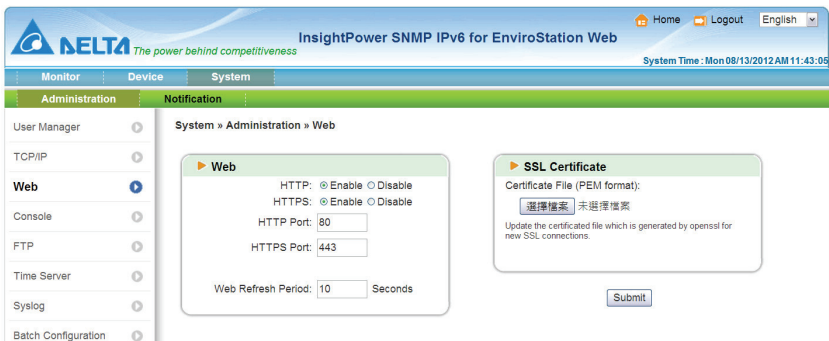

- **Web**

- 1) **HTTP:** Enable/ disable HTTP connection.
- 2) **HTTPS:** Enable/ disable HTTPS connection.
- 3) **HTTP Port:** Assign an HTTP port number (default: 80).
- 4) **HTTPS Port:** Assign an HTTPS port number (default: 443).
- 5) **Web Refresh Period:** Web refresh update interval.

- **SSL Certificate**

- 1) To ensure connection security between the EnviroStation and the connecting workstation, SSL certificates can be used to encrypt and secure the integrity of transmitting data.
- 2) **Certificate File:** This allows you to replace your own SSL certificate file. The EnviroStation supports PEM format which is generated by OpenSSL. Click Choose File to upload a certificate file.



**NOTE:**

For more information regarding generating a private SSL certificate file, please refer to **Chapter 7: Troubleshooting Q12**, or visit <http://www.openssl.org/>.

## ● Console

This page allows you to enable or disable Telnet/ SSH communication protocols and replace DSA/ RSA keys.

The screenshot shows the EnviroStation web interface. The top navigation bar includes 'Monitor', 'Device', and 'System' tabs. The main content area is titled 'System » Administration » Console'. On the left, a sidebar menu lists various system settings, with 'Console' selected. The main configuration area contains three sections: 'Console', 'Host Key', and 'Authentication Public Key'. The 'Console' section has radio buttons for 'Telnet' and 'SSH/SFTP' (both set to 'Enable'), and input fields for 'Telnet Port' (23) and 'SSH Port' (22). The 'Host Key' section has 'DSA Key' and 'RSA Key' fields, each with a '選擇檔案' (Select File) button. Below these is a note: 'Update the certificated files which are generated by openssl for new SSH connections.' The 'Authentication Public Key' section has a 'Public Key' field with a '選擇檔案' (Select File) button and a note: 'Provide the public key for authentication. The public key can be generated by openssl or putty.' A 'Submit' button is located at the bottom right of the configuration area.

- **Telnet:** Enable/ disable Telnet connection.
- **SSH/ SFTP:** Enable/ disable SSH/ SFTP connection.
- **Telnet Port:** Assign a Telnet port number (default: 23).
- **SSH Port:** Assign an SSH protocol port number (default: 22).
- **Host Key:**

DSA/ RSA Key: This allows you to replace your own SSH keys. The EnviroStation supports key files generated by OpenSSH. Please refer to **Chapter 7: Troubleshooting Q13**.



## ○ FTP

This allows you to enable/ disable FTP communication Protocol.

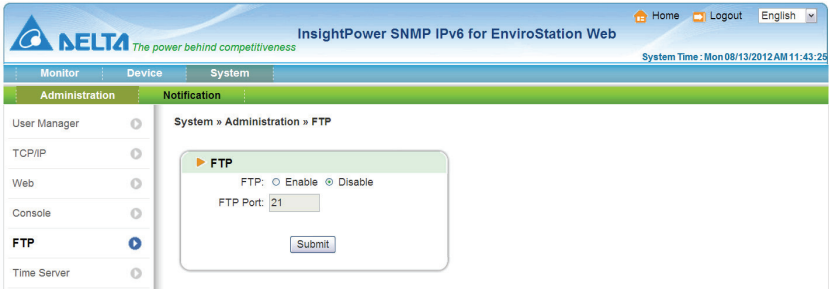

- **FTP:** Enable/ disable FTP connection.
- **FTP Port:** Assign an FTP port number (default: 21).

## ○ Time Server

You can manually set the time and date, or enable automatic time synchronization with SNTP servers. Please note that if the SNTP server is not responsive, the event and data log will not register even when SNTP is enabled.

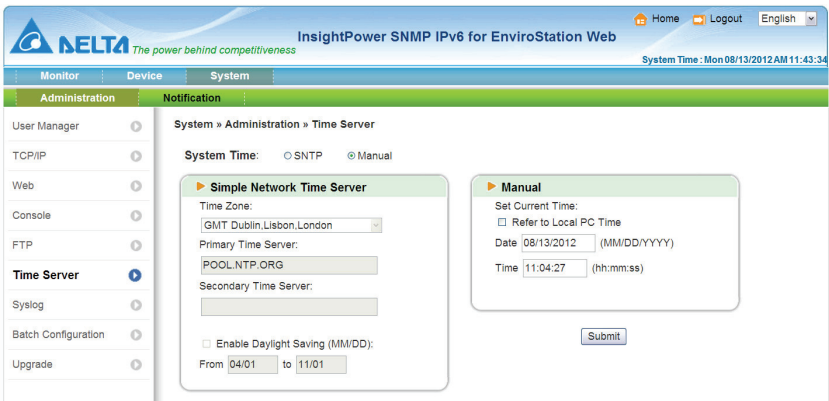

- **Simple Network Time Server**

- 1) **Time Zone:** From the dropdown menu, select the time zone for the location where the EnviroStation is located.
- 2) **Primary/ Secondary Time Server:** Two time servers can be added. Every 60 minutes, the EnviroStation synchronizes with the first responding server.
- 3) **Enable Daylight Saving:** Check to enable daylight saving time. During this period, the EnviroStation adjusts time forward one hour.

- **Manual**

If a time server is not accessible, you can still manually set time and date. Please note that every time you restart EnviroStation's network module, time and date is reinstated to previous assigned settings.

- **Syslog**

Syslog is used to store event log on remote syslog servers. This will not affect the local event log.

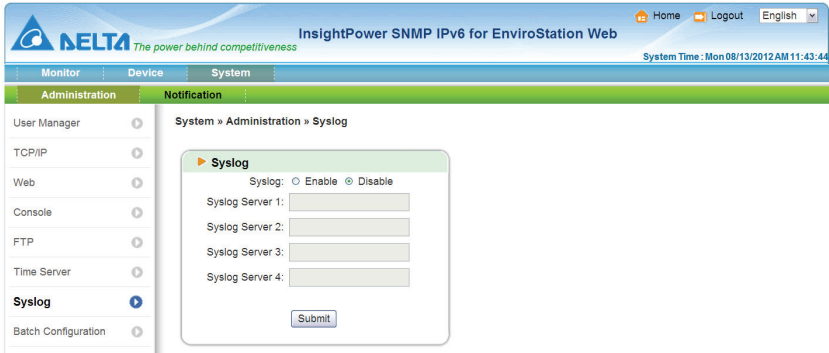

## ● Batch Configuration

The EnviroStation provides batch configuration to allow quick and effortless setup on multiple EnviroStations and SNMP devices. You can duplicate settings by exporting configuration files from the devices that you have successfully configured, and import the configuration files on other devices.

## ● System Configuration

The **System Configuration** includes settings saved in the **Management** and **Administration** tabs. To download a configuration file, simply click **Download**. To upload a configuration file, click **Choose File**, select the file you wish to upload, and click **Upload**.

### NOTE:

If the IP address is static and you wish to copy settings to other devices on the same LAN, you must manually remove the following line **IP=xxx.xxx.xxx.xxx** under the [System] section from the exported configuration file. You can open the configuration file with text editors such as Notepad and WordPad. (To modify/ assign IP address for the EnviroStation, please see **Chapter 4: System Configurations**).

## ● SNMP Configuration

The **SNMP Configuration** includes settings in the **Notification** tab. To download a configuration file, simply click **Download**. To upload a configuration file, click **Choose File**, select the file you wish to upload, and click **Upload**.



### NOTE:

If you need to modify the command lines, please do not delete the unmodified ones. They should be left intact to assure the integrity of the configuration file.

## ○ Upgrade

Check for latest firmware upgrades at <http://59.125.232.140/en/index.aspx>. A firmware upgrade to your EnviroStation can be performed within just a few clicks. Click **Choose File** to select a valid firmware package from your directory, then click **Upload**. The upgrade process should take about one minute to complete.

The screenshot shows the Delta InsightPower SNMP IPv6 for EnviroStation Web interface. The top navigation bar includes "Home", "Logout", and "English". The main navigation menu has "Monitor", "Device", and "System". The "System" menu is expanded to show "Administration" and "Notification". The "Administration" menu is further expanded to show "User Manager", "TCP/IP", "Web", "Console", "FTP", "Time Server", "Syslog", "Batch Configuration", and "Upgrade". The "Upgrade" menu item is highlighted with a blue plus sign. The main content area displays "System » Administration » Upgrade" and a "Network Card Firmware" section. The "Current Ver." is 01.12.09. The "Firmware File:" field has a "Choose File..." button. Below the field is an "Upload" button. The "Description" states: "This feature is used to update the network card firmware. Please follow the following steps to complete the process: Step 1 Select the network card firmware file and press the Upload button to upload the file to the network card. Step 2 Wait about 1 minute for the network card to reprogram the flash and reboot again."

## 5.3.2. Notification

### ○ SNMP Access

The EnviroStation supports SNMP protocol and SNMP NMS (Network Management System), which are commonly used to monitor network devices for conditions that call for administrative attention. To prevent unauthorized access, you can specify the NMS IP addresses that are allowed to access with their respective Community Strings and access levels. The maximum number of IP en-tries is 256.

The screenshot shows the 'SNMP Access' configuration page in the EnviroStation web interface. The page is titled 'System » Notification » SNMP Access'. It features a 'Port Configuration' section with 'SNMP Server Port' set to 161 and a 'Submit' button. Below this is the 'EnviroStation MIB' section with a 'Download MIB' button and links for 'EnviroStation V1' and 'EnviroStation V2'. The 'NMS List' section contains input fields for 'Allowed NMS IP' (0.0.0.0), 'Community String' (public), and 'Access Level' (Read Only), along with 'Add' and 'Update' buttons. A table below lists the current NMS entries.

	NMS IP	Community	Access Level
1	0.0.0.0	public	Read Only



#### NOTE:

If IP address **0.0.0.0** is enlisted, the NMS IP access restriction is ignored. EnviroStation checks the Community Strings to identify the access level and permission according to your setting.

## ● SNMPv3 USM

SNMPv3 offers features such as the encryption of packets and authentication to improve security. The SNMPv3 USM (User Session Management) allows you to assign eight User Names whose access is granted via SNMPv3 protocol. You can also define their respective Security Levels, Auth Passwords, Priv Passwords and Access Level.

System » Notification » SNMPv3 USM

**SNMPv3 USM**

Auth Protocol: MD5      Context Name:

Priv Protocol: CBC-DES

	User Name (16 bytes max.)	Security Level	Auth Password (≥ 8 bytes)	Priv Password (≥ 8 bytes)	Access Level
1	<input type="text"/>	noAuth, noPriv	<input type="text"/>	<input type="text"/>	Read Only
2	<input type="text"/>	noAuth, noPriv	<input type="text"/>	<input type="text"/>	Read Only
3	<input type="text"/>	noAuth, noPriv	<input type="text"/>	<input type="text"/>	Read Only
4	<input type="text"/>	noAuth, noPriv	<input type="text"/>	<input type="text"/>	Read Only
5	<input type="text"/>	noAuth, noPriv	<input type="text"/>	<input type="text"/>	Read Only
6	<input type="text"/>	noAuth, noPriv	<input type="text"/>	<input type="text"/>	Read Only
7	<input type="text"/>	noAuth, noPriv	<input type="text"/>	<input type="text"/>	Read Only
8	<input type="text"/>	noAuth, noPriv	<input type="text"/>	<input type="text"/>	Read Only

## ● SNMP Trap

SNMP Trap alerts users to event occurrences in your monitored environment. To enable SNMP Trap, you must add Target IP addresses to the Target IP list. Specify the Community String, Trap Type, Event Level, SNMPv3 User Name and UDP Port, then click **Add**.

You can determine what event notifications should be sent to the Target IP(s) from **Event Level**. Three Event Levels are listed as follows:

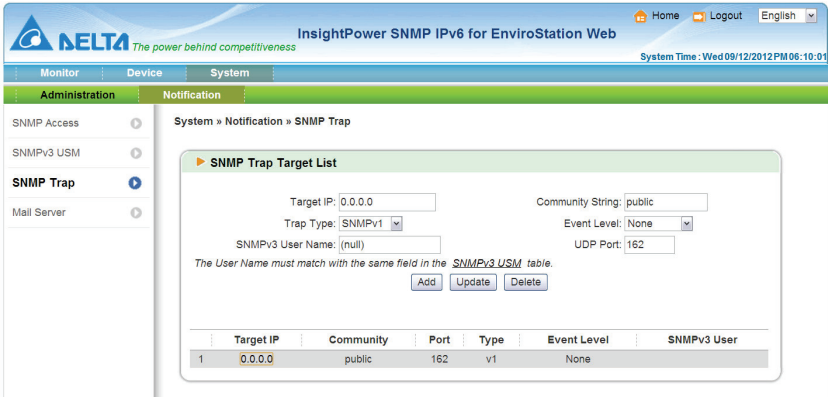

- **Information:** All event notifications are sent to the target address.
- **Warning:** Both Warning and Alarm event notifications are sent to the target address.
- **Alarm:** Only Alarm event notifications are sent to the target address.

## Mail Server

You can set up an SMTP Server and specify a list of E-mail recipients who will receive notifications when events occur. The maximum number of recipients is 256.



### NOTE:

If a DNS server is not available in the network, you need to manually assign an SMTP server address to enable E-mail notification.

System » Notification » Mail Server

**Mail Server Configuration**

SMTP Server Name or IP:  (51 bytes max.)

SMTP Server Port:

Account:  (32 bytes max.)

Password:  (16 bytes max.)

The Account and Password are not required to send emails.

**Mail List**

Receiver:

Event Level:

	Receiver	Event Level
1	name@company.com	None

- **SMTP Server Name or IP:** If a Host Name is entered, a DNS IP should be added in TCP/ IP. Please see **5.3.1 Administration – TCP/ IP**.
- **Account:** The mail server login account.
- **Password:** The mail server login password.
- **Receiver:** The recipients' E-mail addresses.
- **Event Level:** Select the Event Level that when triggered, an E-mail notification is sent to the corresponding recipient.
  - 1) **Information:** All event notifications are sent to the target address.
  - 2) **Warning:** Warning and Alarm event notifications are sent to the target address.
  - 3) **Alarm:** Only Alarm event notifications are sent to the target address.



## Chapter 6 : SNMP Device Firmware Upgrade

With the provided program **EzSetting**, you can effortlessly perform a firmware upgrade for SNMP devices via LAN. Please refer to the following instructions.

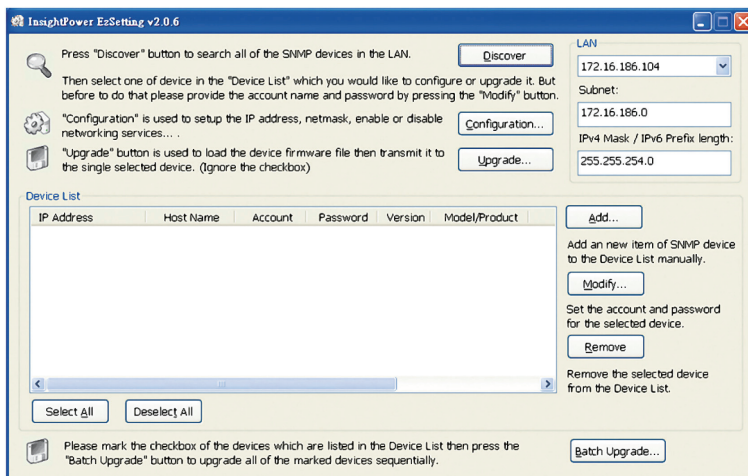

**Step 1** The subnet mask allows you to refine the device discovery range in the specified subnets. Make sure the SNMP device you wish to upgrade is in the subnet that is specified. If it is not, please modify the subnet and subnet mask.

**Step 2** Click **Discover**. A list of SNMP devices is shown.

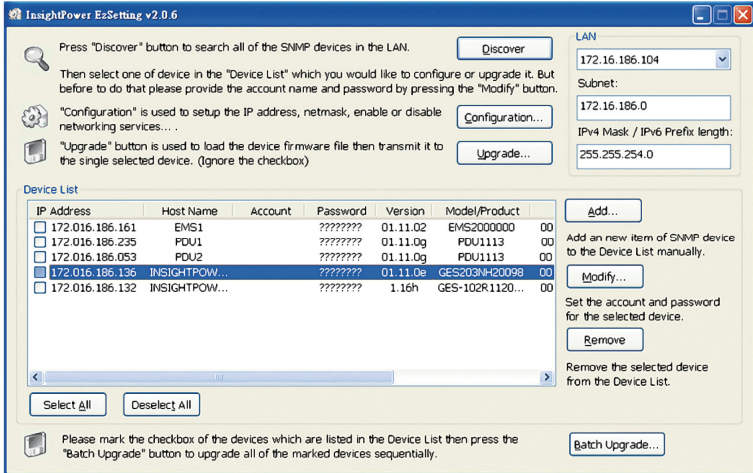

**Step 3** Select a device from the Device List, click **Modify**, and key in Administrator account and password.

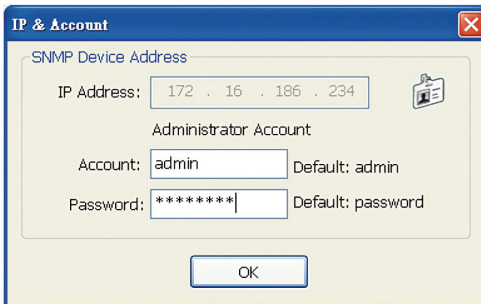

**Step 4** Click **Upgrade**. The upgrade dialog box pops up. Click **Browse** to select a valid firmware binary file. Verify the firmware version listed under File Information, and then click **Upgrade Now** to continue.

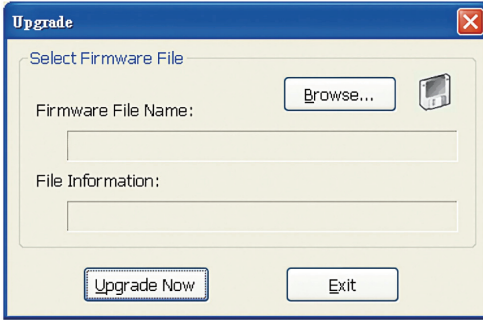

**Step 5** The upgrade process should take about 20 seconds.



**Step 6** When the upgrade is completed, the following dialog box appears. It takes about 1 minute for the device to reboot.



# Chapter 7 : Troubleshooting

## Q1. How to set up an SNTP server on my workstation for EnviroStation to synchronize?

To enable SNTP services in Windows XP, go to **Start** → **Control Panel** → **Add/ Remove Programs** → **Add/ Remove Windows Components** → **Networking Services** → check **Simple TCP/ IP Services** → **OK**. To enable time synchronization, you need to set SNTP time server addresses in **Time Server**. Please refer to **Chapter 4: System Configurations**.

## Q2. How to make sure that network connection is established between my workstation and EnviroStation?

To check connection between the EnviroStation and workstation, in Windows please launch DOS prompt mode (**Start** → **Run** → key in **cmd** and press enter). In Linux, launch Shell. Enter the following command: **ping Host Name** (default: InsightPower). If the connection is correctly established, you should be able to receive replies from the EnviroStation.

```
C:\>ping 172.16.186.230

Pinging 172.16.186.230 with 32 bytes of data:
Reply from 172.16.186.230: bytes=32 time=2ms TTL=64
Reply from 172.16.186.230: bytes=32 time=2ms TTL=64
Reply from 172.16.186.230: bytes=32 time=2ms TTL=64
Reply from 172.16.186.230: bytes=32 time=4ms TTL=64

Ping statistics for 172.16.186.230:
    Packets: Sent = 4, Received = 4, Lost = 0 (0% loss),
    Approximate round trip times in milli-seconds:
        Minimum = 2ms, Maximum = 4ms, Average = 2ms

C:\>
```

## Q3. I can access the login page, but cannot log in to the InsightPower SNMP IPv6 for EnviroStation Web.

Please check the IP addresses of the EnviroStation and the workstation you are trying to log in to. The cause could be they are not connected to the same LAN. In that case, launch **EzSetting** and change **User Limitation** settings to **Allow Any**. Please see the following figure.

**Configuration**

**System Identification**

\*Host Name(NetBIOS):

System Contactor:

System Location:

**Date/Time**

\*SNTP  Manual

Time Zone:

\*1st Time Server Name or IP:

2nd Time Server Name or IP:

Set Current Time: Date:  (MM/DD/YYYY)

Time:  (hh:mm:ss)

**User Limitation**

Administrator:  In The LAN  Allow Any

Device Manager:  In The LAN  Allow Any

Read Only User:  In The LAN  Allow Any

It is recommended to provide a static "IP Address" and disable the "BOOTP/DHCP Client" option.

If it is the first time to configure your InsightPower device, please assign a unique name in the "Host Name" field and given a "Time Server" for the device through "SNTP" protocol if possible.

**IP4**

BOOTP/DHCP Client:  Enable  \*Disable

\*IP Address:

\*Subnet Mask:

Gateway IP:

DNS IP:

**IPv6**

DHCPv6 Client:  Enable  \*Disable

\*IP Address:

\*Prefix Length:

Gateway IP:

DNS IP:

**System Configuration**

HTTP Server:  Enable  Disable

Telnet Server:  Enable  Disable

HTTP Server Port:

Telnet Server Port:

#### Q4. Unable to connect the EnviroStation via its Host name?

If you assign a new static IP address to the EnviroStation, you may need to re-refresh the NetBIOS table so that it corresponds with the new one. Although Windows updates its NetBIOS table periodically, you can still manually force it to refresh by entering the following command **nbstat -R** in DOS prompt mode or shell. After that, you can now connect to the EnviroStation by its Host Name. Please also ensure that the Host Name assigned to the EnviroStation does not exceed 16 bytes.

#### Q5. How to check my workstation's IP address?

For Windows, please enter **ipconfig /all** in DOS prompt mode. For UNIX, please enter **ifconfig** in shell. You should be able to check your IP and MAC (Physical Address) now.

```
Physical Address. . . . . : 00-23-4D-A2-3A-2C
DHCP Enabled. . . . . : Yes
Autoconfiguration Enabled . . . . : Yes
Link-local IPv6 Address . . . . . : fe80::ad55:5b9b:74c6:e5fc%12 (Preferred)
IPv4 Address. . . . . : 172.16.186.97 (Preferred)
Subnet Mask . . . . . : 255.255.254.0

C:\>
```

**Q6. Unable to ping the EnviroStation from my workstation?**

If the **EnviroStation** is non-responsive, check the following:

- 1) If the green LED indicator on the **EnviroStation** is OFF, check if the network cable is correctly connected from the **EnviroStation** to the router or hub.
- 2) If the green LED indicator is ON, the current IP address could be unreachable. Manually assign a valid IP address to the **EnviroStation**.
- 3) If the green LED indicator flashes and (1) your network configuration includes a DHCP server, make sure the DHCP service is working properly; (2) Otherwise, make sure the assigned IP is not already taken on the network. Please note that if the current configuration is not useable, the **EnviroStation** will reset to default IP settings (IPv4 address: 192.168.1.100/ net mask: 255.255.255.0/ gateway: 192.168.1.254).
- 4) If the problem persists, use a network cable to cross link your **EnviroStation** and the workstation. Ping the **EnviroStation**'s default or static IP address, according to your configurations. If a ping response is successfully received, indicating that the **EnviroStation** is working properly. Check your network equipment. If not, contact your local dealer or service personnel for assistance.

**Q7. Unable to perform an SNMP Get command?**

Refer to **5.3.2 Notification** to check SNMP settings. Make sure that the workstation's IP address is added to the NMS IP list with Read or Read/ Write access. The community string on the workstation and the SNMP IPv6 must match.

**Q8. Unable to perform an SNMP Set command?**

Refer to **5.3.2 Notification** to check SNMP settings. Make sure that the workstation's IP address is added to the NMS IP list with Read or Read/ Write access. The community string on the workstation and the SNMP IPv6 must match.

**Q9. Unable to receive SNMP trap?**

Refer to **5.3.2 Notification** to check SNMP Trap settings. Make sure that the workstation's IP address is added to the Target IP list.

**Q10. Forgot Administrator's account and password?**

You can reset Administrator's account and password via text mode. Refer to **4.4 Configuring through COM Port** to establish a COM port connection with the EnviroStation. When the login information is prompted, key in **rstadmin** within 30 seconds and press **enter**. The Administrator account and password are now reset to default (admin/ password).

**Q11. How to enable IPv6 in Windows XP?**

If you are operating in Windows XP, please enable IPv6 first (click **START** → **RUN**, and enter **ipv6 install**). The EnviroStation supports IPv6, therefore, no additional configuration is required. However, please note that IPv6 is automatically disabled if an identical LLA (Local-link Address) already exists in the LAN. Also, when the IPv4 and IPv6 settings coexist, IPv4 is used as the primary IP address for the EnviroStation.

To learn more information regarding IPv6 compatibility, please visit IETF (<http://tools.ietf.org/html>), or **IPv6 Ready Logo Program** (<http://www.ipv6ready.org>).

**Q12. How to generate a private SSL (Secure Socket Layer) certificate file (in PEM format) for HTTP connection?**

To ensure connection security between the EnviroStation and your browser, you can create your own SSL certificate file in Linux. Please download and in-stall OpenSSL from <http://www.openssl.org>, launch shell and enter the following command to create your own certificate file:

```
openssl req -x509 -nodes -days 3650 -newkey rsa:1024 -keyout cert.pem -out cert.pem
```

- 1) Answer the prompted questions. Proceed as directed by the messages. Once it is completed, a file named **cert.pem** is created in the current working directory.
- 2) Upload **cert.pem** on the InsightPower SNMP IPv6 for EnviroStation Web. Please refer to **5.3.1 Administration – Web**.

**Q13. How to generate DSA and RSA keys for SSH?**

**For Linux:**

- 1) Please download and install OpenSSH from <http://www.openssh.org>.

- 2) Launch shell and enter the following command to create your own keys:  
Please ignore it when prompted to provide passphrase.

DSA Key:ssh-keygen -t dsa

RSA Key:ssh-keygen -t rsa

- 3) Upload DSA and RSA key files on the InsightPower SNMP IPv6 for EnviroStation Web. Please refer to **5.3 Administration – Console** for more information.

#### For Windows:

- 1) Please download and install PuTTY from <http://www.putty.org>.
- 2) Run **puttygen.exe** from the installed directory.
- 3) Select **SSH-2 RSA** from the Parameters area and click **Key** → **Generate key** pair to generate an RSA key.
- 4) Select **Conversions** → **Export OpenSSH Key** and assign a file name to the RSA key. Please ignore it when prompted to provide key passphrase.

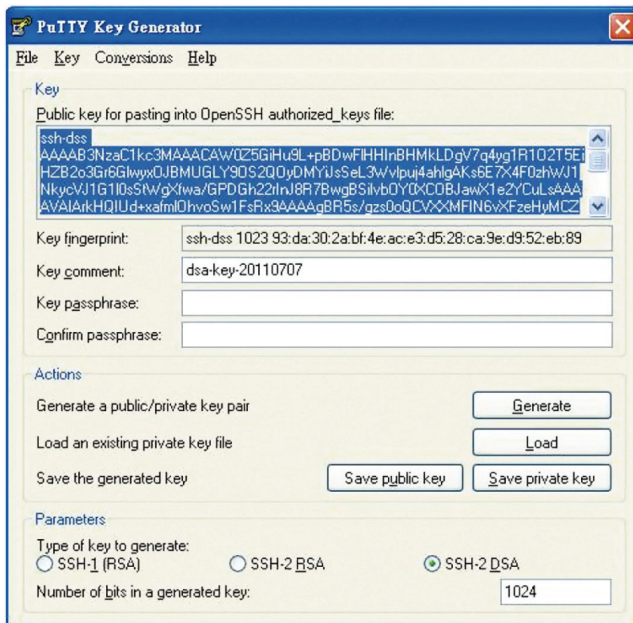



- 5) Select **SSH-2 DSA** from the Parameters area and select **Key** → **Generate key pair** to generate a DSA key.
- 6) Select **Export OpenSSH Key** from **Conversions** and assign a file name to the DSA key. Please ignore it when prompted to provide key passphrase.
- 7) Copy the generated key from the text box, paste in a text editor and save as a text file.
- 8) Upload the DSA/ RSA/ Public key files to the InsightPower SNMP IPv6 for EnviroStation Web. Please refer to **5.3 Administration – Console** for more information.

#### Q14. How to upload configuration / firmware / key files via SSH/ SFTP?

To quickly configure your SNMP IPv6, you can upload the files via SSH/ SFTP. The SNMP IPv6 automatically imports your settings after the files are uploaded to the designated directories. Refer to the following table:

Directory	Files
\config_snmp	snmp.ini
\config_system	configure.ini
\ssh_dsa	DSA Key
\ssh_rsa	RSA Key
\ssh_pubkey	Public Key
\upgrade_snmp	EnviroStation firmware upgrade package (binary)
\upgrade_device*	Device's firmware upgrade package (binary)

\* Appears on specific devices only.

Upload files to their respective directories. Make sure the filenames do not contain non-English characters to avoid read error. Overwrite existing files if prompted by your SFTP client.

#### Q15. How to test SNMPv3 in Linux?

Before you can access the SNMP OID (Object Identifier) via SNMPv3 protocol, the SNMPv3 USM table must be organized. Please refer to **5.3.2**

**Notification – SNMPv3 USM** for more information.

To test SNMPv3 in Linux, launch shell and key in the following command:

```
snmpwalk -v 3 -u <user> -l authPriv -A <password> -X <pass-word> -n  
<context name> -t 3 <ip> 1.3.6.1.2.1.1.1.0
```

-v : 1 for SNMPv1, 3 for SNMPv3.

-l : Follow the security levels. They are: noAuthNoPriv, authNoPriv and authPriv.

-u : The user name which is assigned from SNMPv3 USM table.

-A : The Auth Password which is assigned from SNMPv3 USM table.

-X : The Priv Password which is assigned from SNMPv3 USM table.

-n : The Context Name which is assigned from SNMPv3 USM table.

-t : Timeout in seconds.

<ip> : The IP address of the EnviroStation.

<oid> : The next available SNMP OID (For example: 1.3.6.1.2.1.1.1.0). Please refer to the RFC1213 MIB.

#### **Q16. Why EnviroStation cannot monitor PDU devices?**

Monitoring PDU devices is disabled (EnviroStation default). To monitor PDU devices, please use the InsightPower SNMP IPv6 for EnviroStation Web (**Device** → **Management** → **PDU**) to reset the default setting. Please refer to **Chapter 5: InsightPower SNMP IPv6 for EnviroStation Web**.

## Appendix A : Specifications

Item	Model	Part no.
	EMS2000	EMS2000000
<b>Input</b>		
Power Input	100 ~ 240 Vac, 1.2A, 50/60 Hz	
Digital Input	Wet Contact signal ● Alarm Voltage: 5 ~ 24 Vdc Dry Contact signal ● Normal: Off (open circuit) ● Alarm: On (short circuit)	
Analog Input	Input Voltage: 0 ~ 10V Input Current: 0 ~ 20 mA	
RTD	Range: 0 ~ 50°C Accuracy: ± 1°C with 3-wire PT100	
Leakage	Detect Voltage < 1V (alarm signal with S-1FP leak sensor)	
Network Connection	RJ45 jack connector	
<b>Output</b>		
Sensor HUB	+ 12V, 0.8A (max) + 24V, 1.0A (max) One port limit 0.6A	
Delta Bus	+ 12V, 0.8A (max)	
Relay Outputs	26 Vdc (max), 0.8A (max)	
<b>Physical</b>		
Size (W x D x H)	440 x 157 x 44 mm	
Weight	2.4 kg	
<b>Environmental</b>		
Operating Temperature	0 ~ 45°C	
Storage Temperature	- 20°C ~ 60°C	
Operating Humidity	0 ~ 90% RH (non-condensing)	

**NOTE:**

1. Refer to the rating label for the safety rating.
2. All specifications are subject to change without prior notice.

## Appendix B : Warranty

Seller warrants this product, if used in accordance with all applicable instructions, to be free from original defects in material and workmanship within the warranty period. If the product has any failure problem within the warranty period, Seller will repair or replace the product at its sole discretion according to the failure situation.

This warranty does not apply to normal wear or to damage resulting from improper installation, operation, usage, maintenance or irresistible force (i.e. war, fire, natural disaster, etc.), and this warranty also expressly excludes all incidental and consequential damages.

Maintenance service for a fee is provided for any damage out of the warranty period. If any maintenance is required, please directly contact the supplier or Seller.



### **WARNING:**

The individual user should take care to determine prior to use whether the environment and the load characteristic are suitable, adequate or safe for the installation and the usage of this product. The User Manual must be carefully followed. Seller makes no representation or warranty as to the suitability or fitness of this product for any specific application.







