

DELPHI SERIES



FEATURES

- ◆ High Efficiency:
92.0% @ 12Vin, 5V/10A out
- ◆ Size: 17.15mm x 13.97mm x 8.07 mm
(0.67" x 0.55" x 0.31")
- ◆ Wide input range: 2.97V~13.2V
- ◆ Output voltage programmable from 0.59Vdc to 5Vdc via external resistors
- ◆ No minimum load required
- ◆ Fixed frequency operation
- ◆ Power Good and sense functions
- ◆ output OCP, SCP, OVP
- ◆ Remote ON/OFF (Positive)
- ◆ ISO 9001, TL 9000, ISO 14001, QS9000, OHSAS18001 certified manufacturing facility

DUS1250Ex Series Non-Isolated Point of Load DC/DC Modules: 2.97~13.2Vin, 0.59V-5Vout, 10Aout

The Delphi DUS1250Ex series, 2.97V~13.2V wide input, 10A, wide trim single output, non-isolated point of load (POL) DC/DC converters are the latest offering from a world leader in power systems technology and manufacturing — Delta Electronics, Inc. The DUS1250Ex product family is the second generation, non-isolated point-of-load DC/DC power modules which cut the module size by almost 50% in most of the cases compared to the first generation NC series POL modules. The DUS1250xx product family provides an ultra wide input range to support 3.3V, 5V, and 12V bus voltage point-of-load applications and it offers up to 10A of output current in a vertically mounted through-hole miniature package and the output can be resistor trimmed from 0.59Vdc to 5 Vdc. It provides a very cost effective, high efficiency, and high density point of load solution. With creative design technology and optimization of component placement, these converters possess outstanding electrical and thermal performance, as well as extremely high reliability under highly stressful operating conditions.

OPTIONS

APPLICATIONS

- ◆ DataCom
- ◆ Distributed power architectures
- ◆ Servers and workstations
- ◆ LAN/WAN applications
- ◆ Data processing applications

TECHNICAL SPECIFICATIONS

(Ambient Temperature=25°C, minimum airflow=250LFM, nominal V_{in} =12Vdc unless otherwise specified.)

PARAMETER	NOTES and CONDITIONS	DUS1250Ex			
		Min.	Typ.	Max.	Units
ABSOLUTE MAXIMUM RATINGS					
Input Voltage		0		14	Vdc
Operating Temperature	Refer to Fig.58 for the measuring point	0		50	°C
Storage Temperature		-40		125	°C
INPUT CHARACTERISTICS					
Operating Input Voltage		2.97		13.2	V
Maximum Input Current	12Vin, 5Vo, operating, full load		4.5		A
Input Reflected-Ripple Current			5	10	mA
Input Voltage Power on Slew Rate	$V_{in}=5V, I_o=10A, V_o=3.3V$	1			V/ms
	$V_{in}=12V, I_o=10A, V_o=3.3V$ or 5V	1			V/ms
OUTPUT CHARACTERISTICS					
Output Voltage Adjustment Range		0.59		5.0	Vdc
Output Voltage Set Point	With a 1% trim resistor	-3		+3	%
Output Ripple, 20MHz BW, 12Vin	10uF 1210 x2, 1uF 0805 x2 and 100nF 0603 x5 ceramic capacitor plus 470uF/6.3V POS cap			30	mVp-p
	Same as above			50	mVp-p
Output Current Range		0		10	A
Output Rise Time	10% to 90% of Vo	1		15	mS
Overshoot at Turn-on/Turn-Off	$V_{in}=12V, I_o=\text{min}\sim\text{max}$			5	% of Vo
Output DC Current-Limit Inception	Hiccup mode		15		A
DYNAMIC CHARACTERISTICS					
Output Dynamic Load Response	12Vin, 5Vout, 470uF ceramic cap				
Positive Step Change in Output Current	70~100% load, 10A/uS			130	mV
Negative Step Change in Output Current	100~70% load, 10A/uS			130	mV
Recovery Time	Recovery to within regulation band		200		us
Turn-On Transient					
Start-Up Time, from On/Off Control	From Enable high to 90% of Vo	0		25	ms
Start-Up Time, from input power	From $V_{in}=12V$ to 90% of Vo	0		50	ms
Minimum Output Capacitance	0.9V and above	0			uF
	0.8V	22			uF
	0.7V	100			uF
	0.6V	220			uF
	0.59V	470			uF
Maximum Output Startup Capacitive Load	Full Load, 12Vin, 5Vo			1000	uF
EFFICIENCY					
$V_{in}=12V, I_o=10A$	$V_o=0.59V$		64		%
	$V_o=1.5V$		81		%
	$V_o=2.5V$		86		%
	$V_o=3.3V$		89		%
	$V_o=5.0V$		91		%
$V_{in}=5V, I_o=10A$	$V_o=0.59V$		72		%
	$V_o=1.5V$		85		%
	$V_o=2.5V$		90		%
	$V_o=3.3V$		92		%
$V_{in}=3.3V, I_o=10A$	$V_o=0.59V$		69		%
	$V_o=1.5V$		83		%
	$V_o=2.5V$		88		%
FEATURE CHARACTERISTICS					
Switching Frequency	Fixed		600		KHz
Power Good Range	PWRGD=High @ Vo is in spec	-9%		15%	Vo
Power Good Delay Time	From 90% of Vo to 90% of Power Good output signal	0		10	mS
Power Good Rise Time	10% to 90% of Power good signal rise	0		1	mS
ON/OFF Control	Positive logic (internally pulled high)				
Logic High	Module On (or leave the pin open)	1.7		3.3	V
Logic Low	Module Off	0		0.8	V
GENERAL SPECIFICATIONS					
Calculated MTBF	25°C, 300LFM, 80% load		2		Mhours
Weight			2.5		grams



ELECTRICAL CHARACTERISTICS CURVES

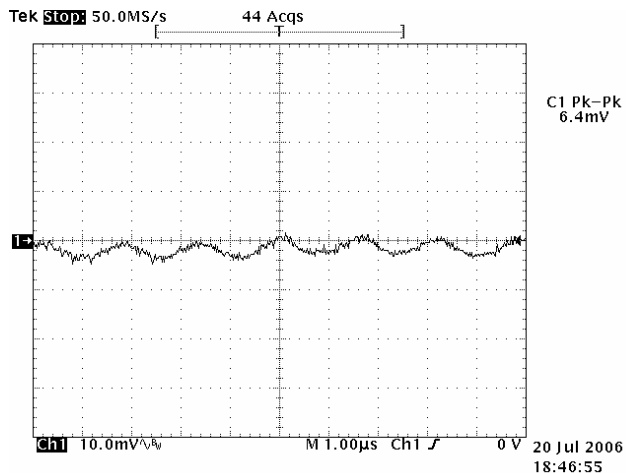

Figure 1: Output Ripple & Noise
($V_{in}=2.97V$, $V_{out}=0.59V/10A$, Environment Temp= $25^{\circ}C$)

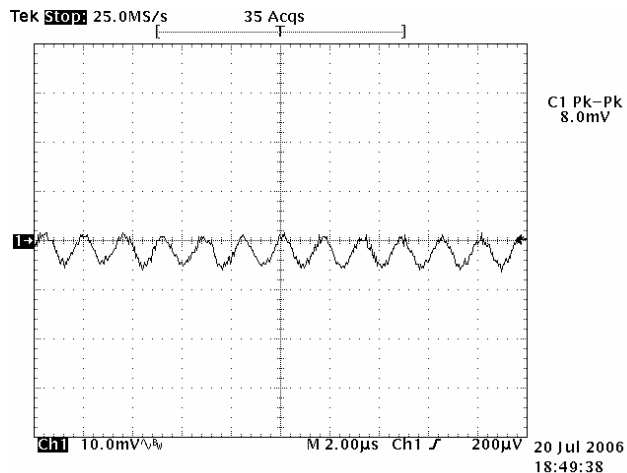

Figure 2: Output Ripple & Noise
($V_{in}=3.63V$, $V_{out}=1.5V/10A$, Environment Temp= $25^{\circ}C$)

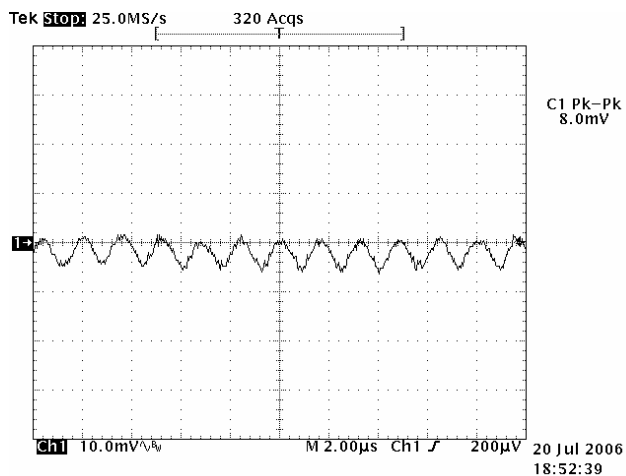

Figure 3: Output Ripple & Noise
($V_{in}=3.3V$, $V_{out}=2.5V/10A$, Environment Temp= $25^{\circ}C$)

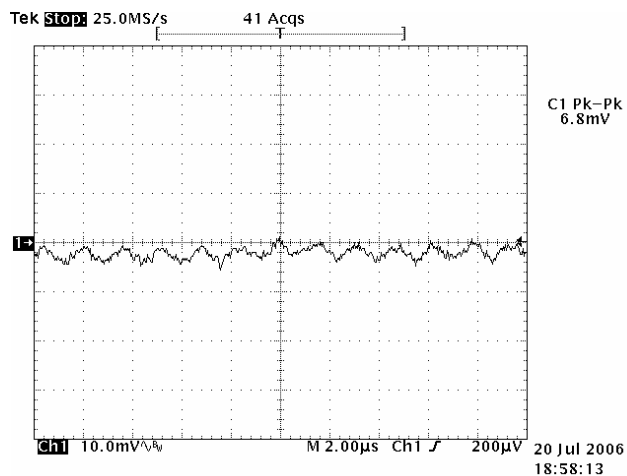

Figure 4: Output Ripple & Noise
($V_{in}=5.5V$, $V_{out}=0.59V/10A$, Environment Temp= $25^{\circ}C$)

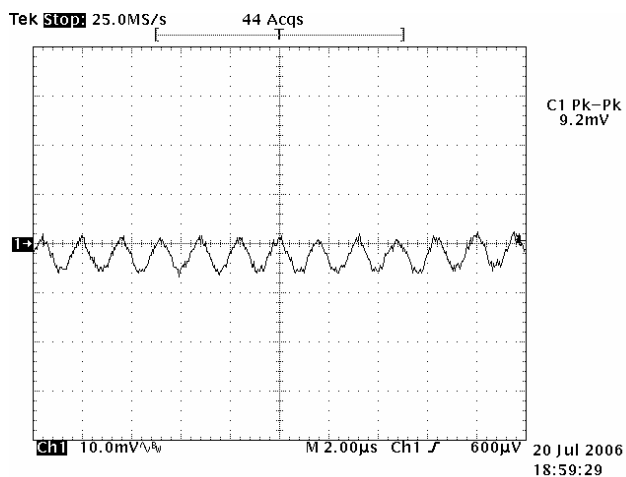

Figure 5: Output Ripple & Noise
($V_{in}=5.0V$, $V_{out}=1.5V/10A$, Environment Temp= $25^{\circ}C$)

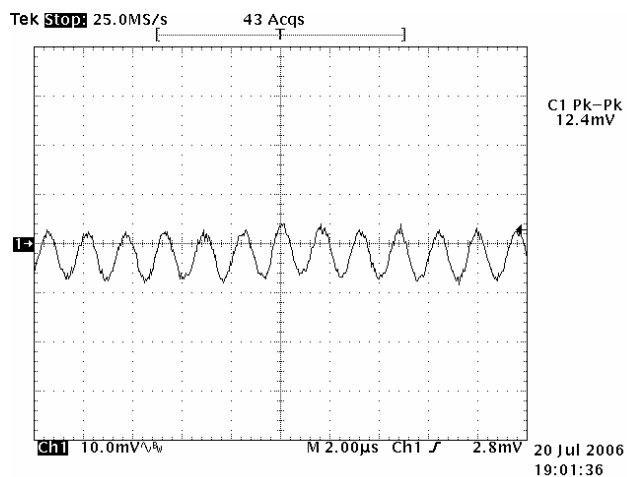

Figure 6: Output Ripple & Noise
($V_{in}=5.5V$, $V_{out}=2.5V/10A$, Environment Temp= $25^{\circ}C$)



ELECTRICAL CHARACTERISTICS CURVES (CON.)

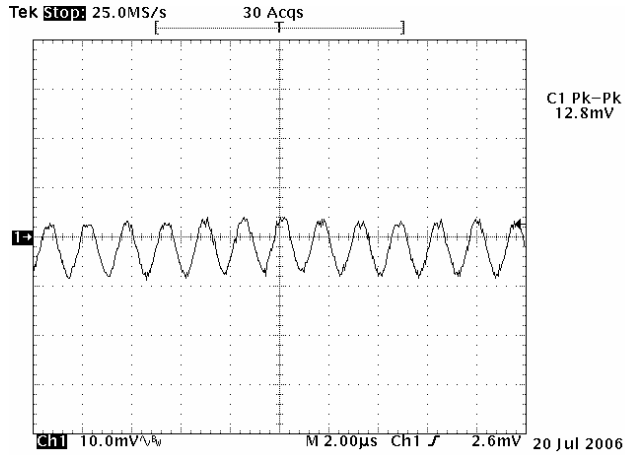

Figure 7: Output Ripple & Noise
($V_{in}=5.5V$, $V_{out}=3.3V/10A$, Environment Temp.= $25^{\circ}C$)

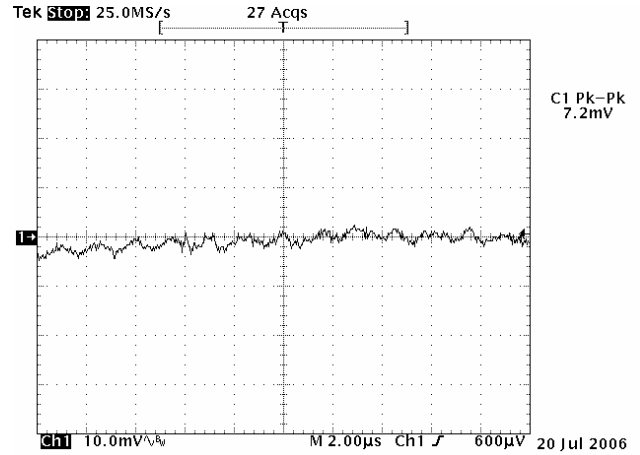

Figure 8: Output Ripple & Noise
($V_{in}=12V$, $V_{out}=0.59V/10A$, Environment Temp.= $25^{\circ}C$)

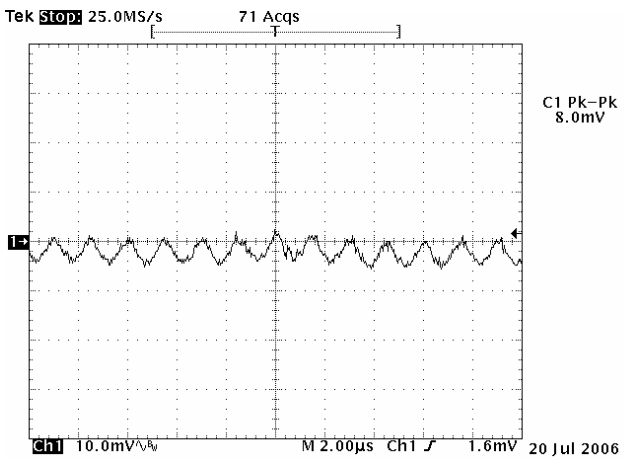

Figure 9: Output Ripple & Noise
($V_{in}=12V$, $V_{out}=1.5V/10A$, Environment Temp.= $25^{\circ}C$)

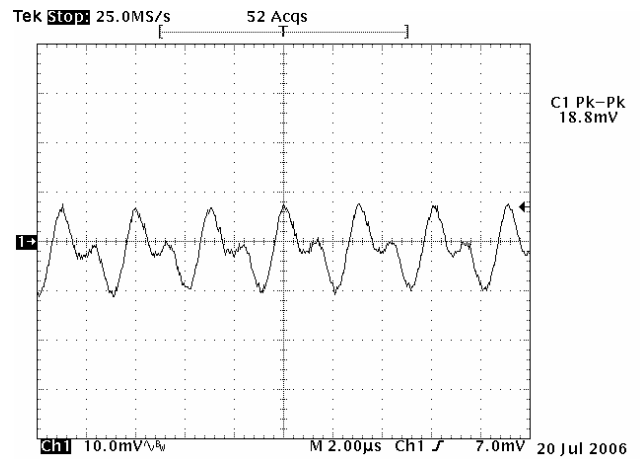

Figure 10: Output Ripple & Noise
($V_{in}=13.2V$, $V_{out}=2.5V/10A$, Environment Temp.= $25^{\circ}C$)

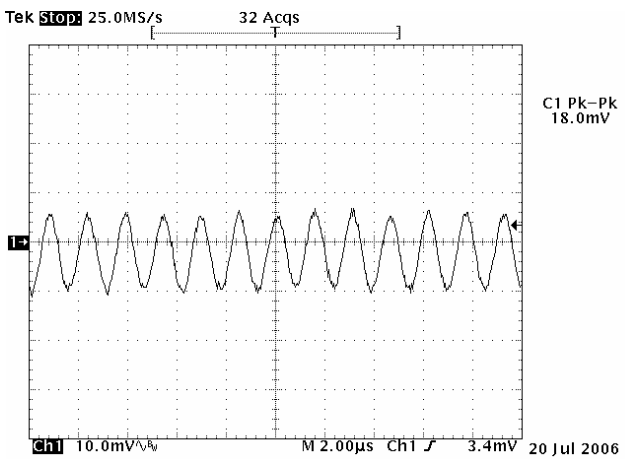

Figure 11: Output Ripple & Noise
($V_{in}=12V$, $V_{out}=3.3V/10A$, Environment Temp.= $25^{\circ}C$)

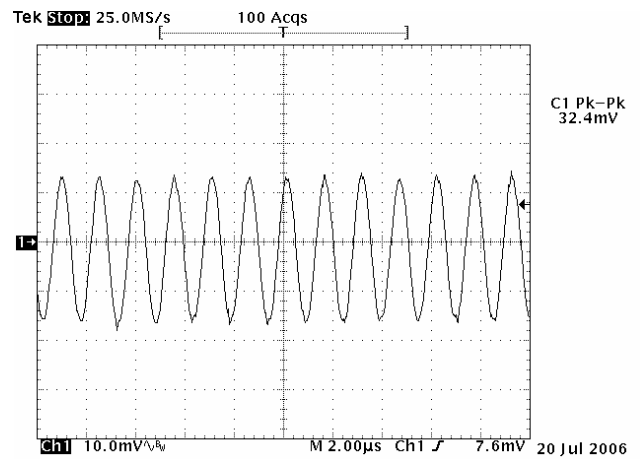

Figure 12: Output Ripple & Noise
($V_{in}=13.2V$, $V_{out}=5V/10A$, Environment Temp.= $25^{\circ}C$)



ELECTRICAL CHARACTERISTICS CURVES (CON.)

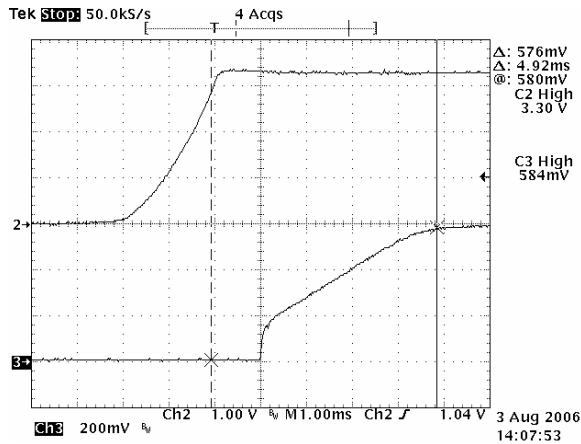

Figure 13: Turn on by Vin
 ($V_{in}=3.3V$, $V_{out}=0.59V/10A$, CH2: Vin, CH3: Vout)

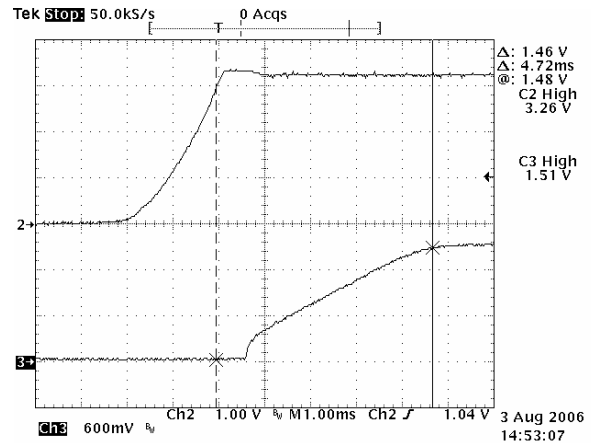

Figure 14: Turn on by Vin
 ($V_{in}=3.3V$, $V_{out}=1.5V/10A$, CH2: Vin, CH3: Vout)

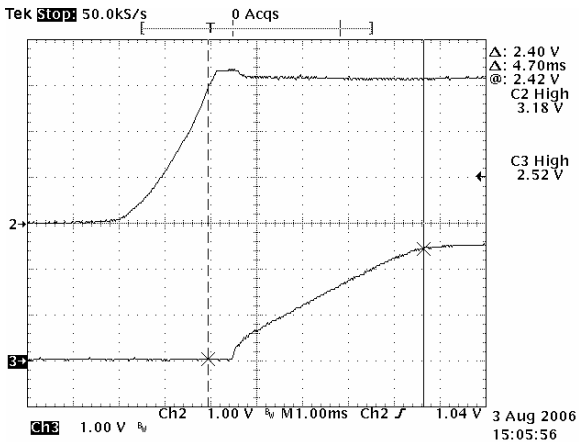

Figure 15: Turn on by Vin
 ($V_{in}=3.3V$, $V_{out}=2.5V/10A$, CH2: Vin, CH3: Vout)

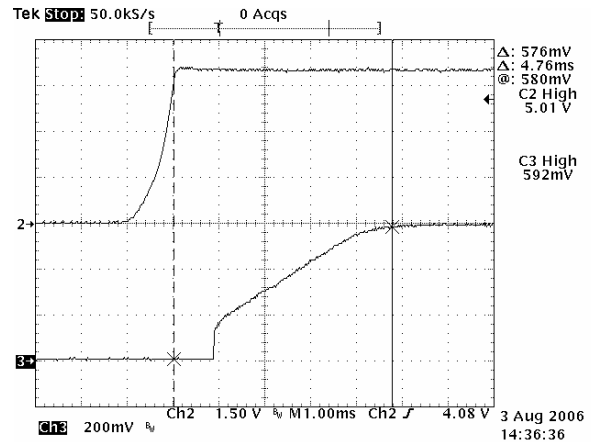

Figure 16: Turn on by Vin
 ($V_{in}=5V$, $V_{out}=0.59V/10A$, CH2: Vin, CH3: Vout)

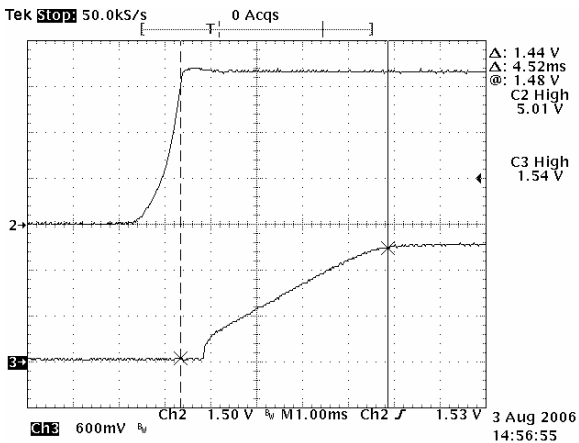

Figure 17: Turn on by Vin
 ($V_{in}=5V$, $V_{out}=1.5V/10A$, CH2: Vin, CH3: Vout)

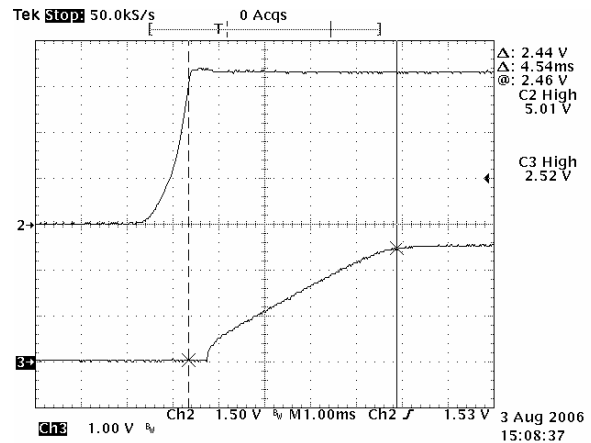

Figure 18: Turn on by Vin
 ($V_{in}=5V$, $V_{out}=2.5V/10A$, CH2: Vin, CH3: Vout)



ELECTRICAL CHARACTERISTICS CURVES (CON.)

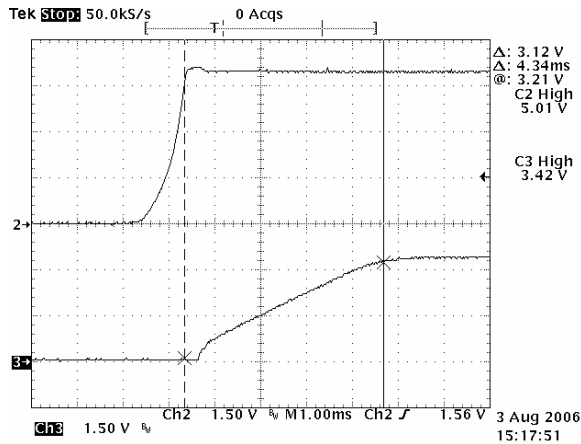

Figure 19: Turn on by V_{in}
 ($V_{in}=5V$, $V_{out}=3.3V/10A$, CH2: V_{in} , CH3: V_{out})

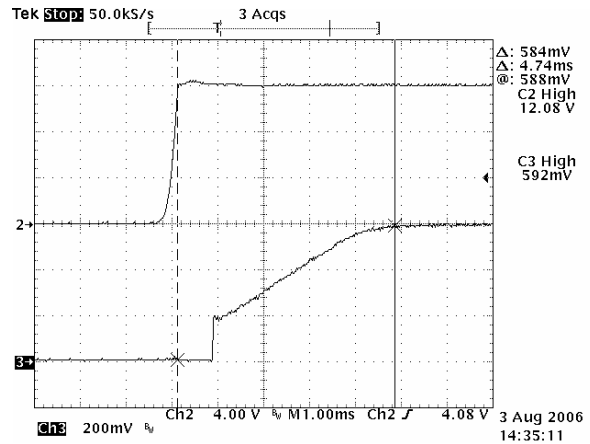

Figure 20: Turn on by V_{in}
 ($V_{in}=12V$, $V_{out}=0.59V/10A$, CH2: V_{in} , CH3: V_{out})

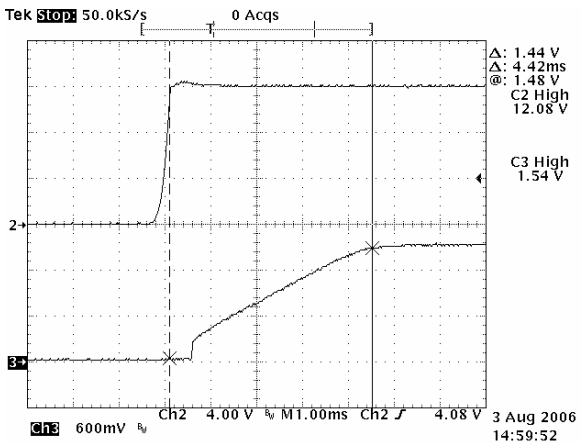

Figure 21: Turn on by V_{in}
 ($V_{in}=12V$, $V_{out}=1.5V/10A$, CH2: V_{in} , CH3: V_{out})

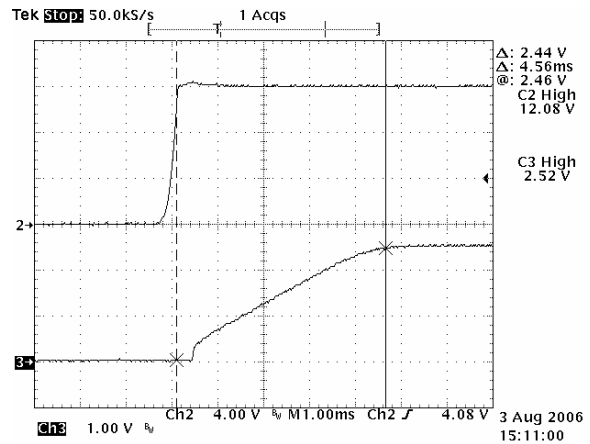

Figure 22: Turn on by V_{in}
 ($V_{in}=12V$, $V_{out}=2.5V/10A$, CH2: V_{in} , CH3: V_{out})

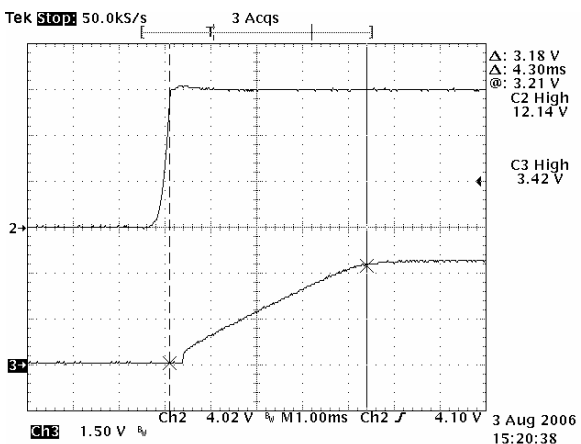

Figure 23: Turn on by V_{in}
 ($V_{in}=12V$, $V_{out}=3.3V/10A$, CH2: V_{in} , CH3: V_{out})

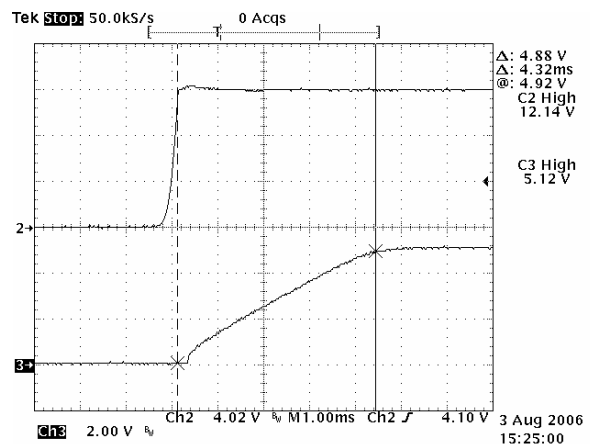

Figure 24: Turn on by V_{in}
 ($V_{in}=12V$, $V_{out}=5V/10A$, CH2: V_{in} , CH3: V_{out})



ELECTRICAL CHARACTERISTICS CURVES (CON.)

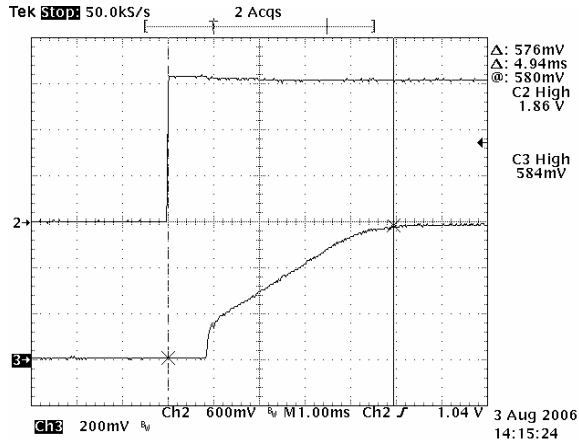

Figure 25: Turn on by on/off
 ($V_{in}=3.3V$, $V_{out}=0.59V/10A$, CH2: V_{in} , CH3: V_{out})

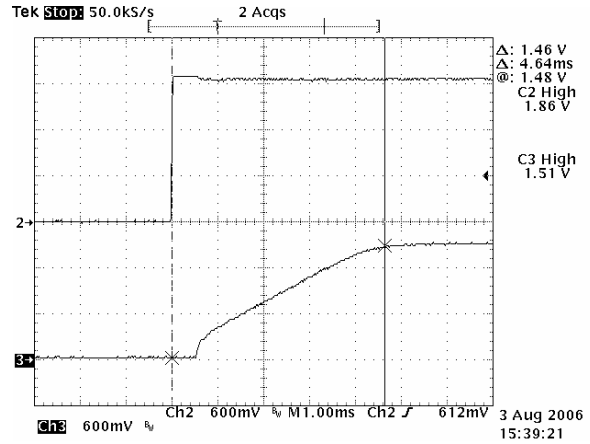

Figure 26: Turn on by on/off
 ($V_{in}=3.3V$, $V_{out}=1.5V/10A$, CH2: V_{in} , CH3: V_{out})

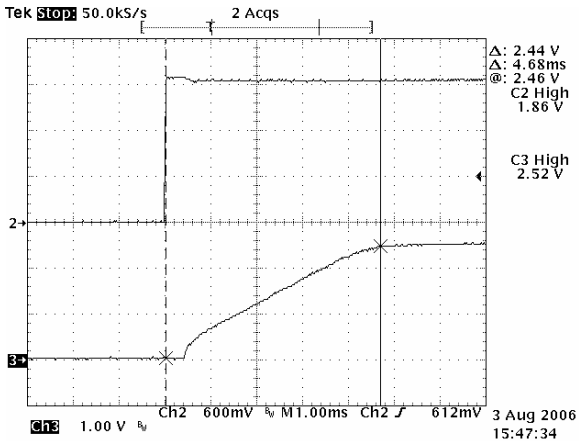

Figure 27: Turn on by on/off
 ($V_{in}=3.3V$, $V_{out}=2.5V/10A$, CH2: V_{in} , CH3: V_{out})

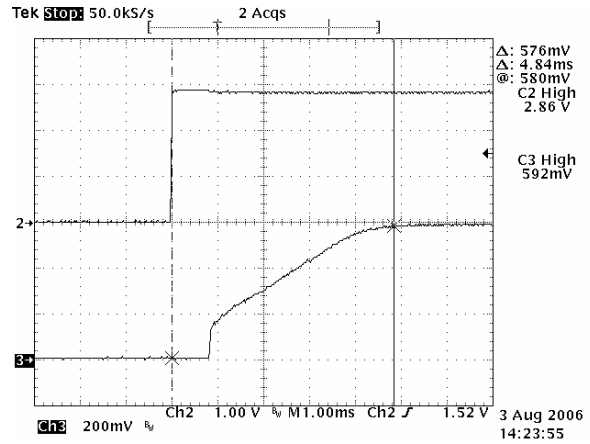

Figure 28: Turn on by on/off
 ($V_{in}=5V$, $V_{out}=0.59V/10A$, CH2: V_{in} , CH3: V_{out})

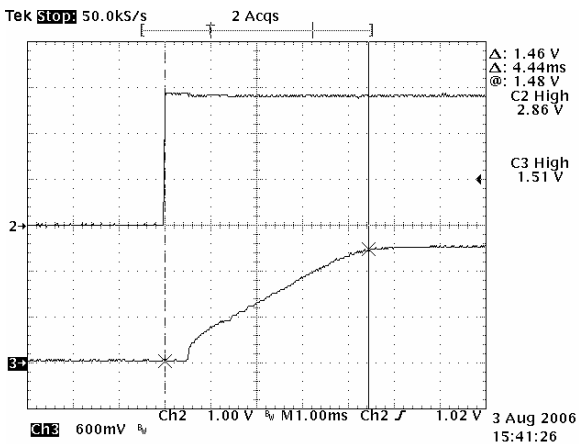

Figure 29: Turn on by on/off
 ($V_{in}=5V$, $V_{out}=1.5V/10A$, CH2: V_{in} , CH3: V_{out})

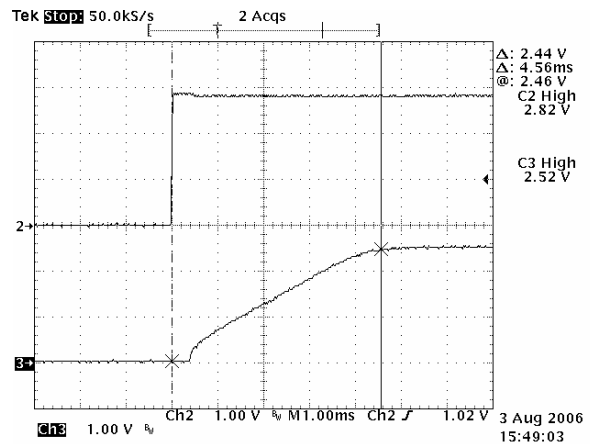

Figure 30: Turn on by on/off
 ($V_{in}=5V$, $V_{out}=2.5V/10A$, CH2: V_{in} , CH3: V_{out})



ELECTRICAL CHARACTERISTICS CURVES (CON.)

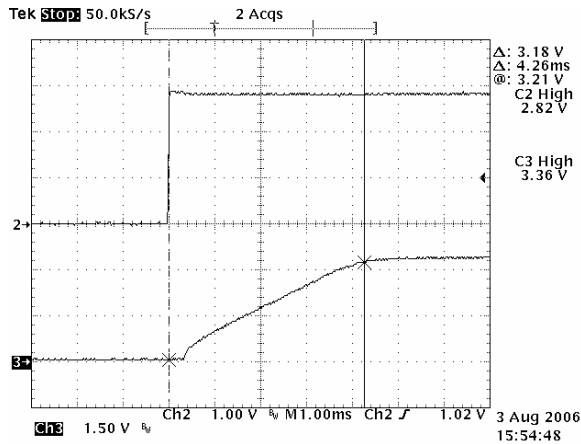

Figure 31: Turn on by on/off
($V_{in}=5V$, $V_{out}=3.3V/10A$, CH2: V_{in} , CH3: V_{out})

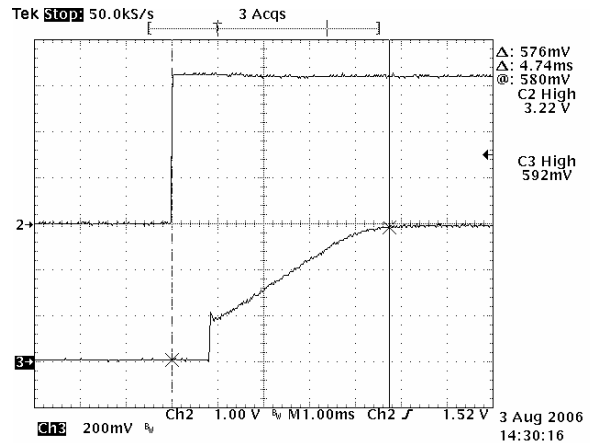

Figure 32: Turn on by on/off
($V_{in}=12V$, $V_{out}=0.59V/10A$, CH2: V_{in} , CH3: V_{out})

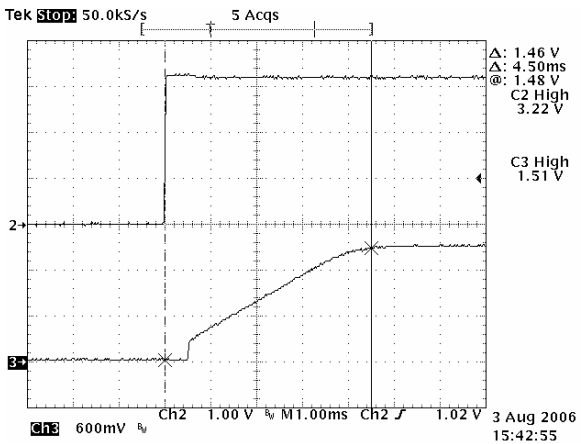

Figure 33: Turn on by on/off
($V_{in}=12V$, $V_{out}=1.5V/10A$, CH2: V_{in} , CH3: V_{out})

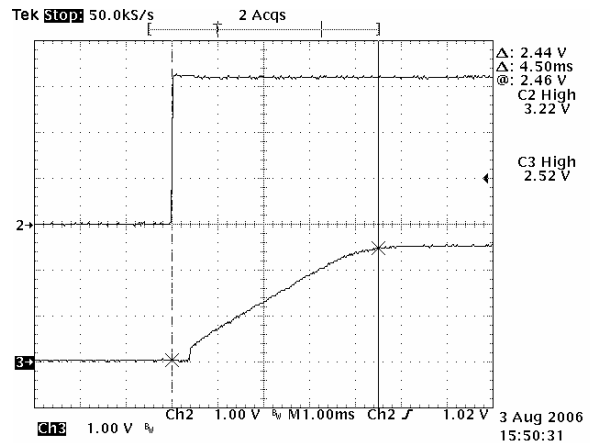

Figure 34: Turn on by on/off
($V_{in}=12V$, $V_{out}=2.5V/10A$, CH2: V_{in} , CH3: V_{out})

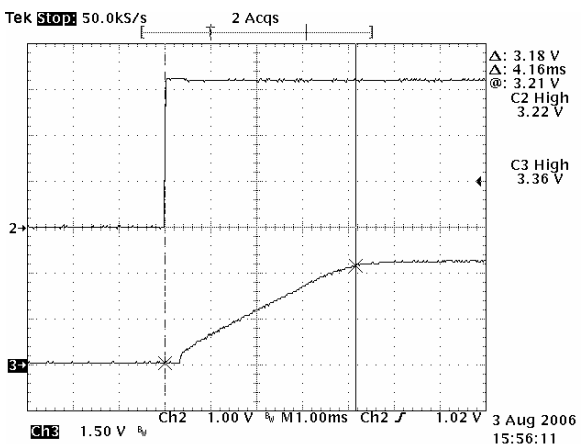

Figure 35: Turn on by on/off
($V_{in}=12V$, $V_{out}=3.3V/10A$, CH2: V_{in} , CH3: V_{out})

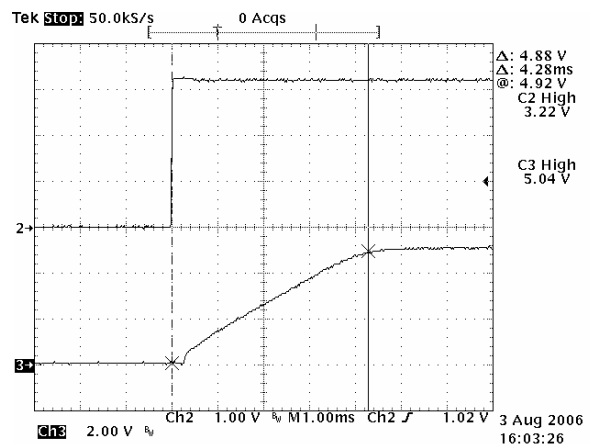

Figure 36: Turn on by on/off
($V_{in}=12V$, $V_{out}=5V/10A$, CH2: V_{in} , CH3: V_{out})



ELECTRICAL CHARACTERISTICS CURVES (CON.)

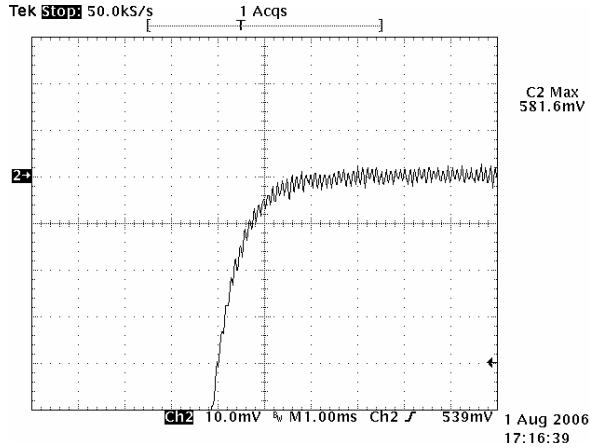

Figure 37: Turn on overshoot
($V_{in}=3.3V$, $V_{out}=0.59V/10A$, CH2: V_{out} (turn on by OE))

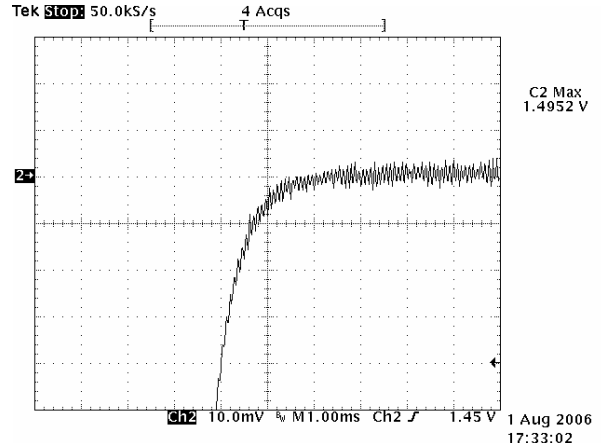

Figure 38: Turn on overshoot
($V_{in}=3.3V$, $V_{out}=1.5V/10A$, CH2: V_{out} (turn on by OE))

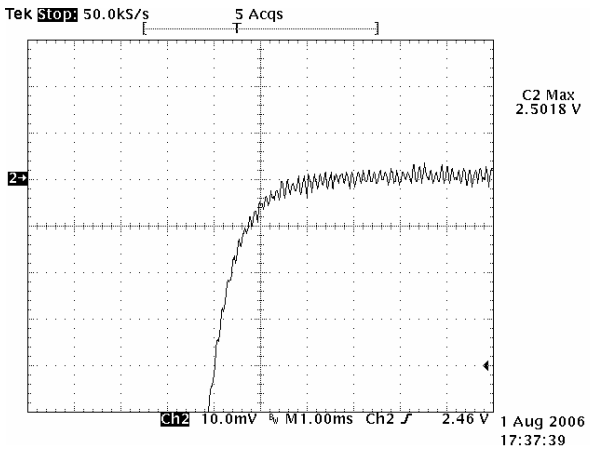

Figure 39: Turn on overshoot
($V_{in}=3.3V$, $V_{out}=2.5V/10A$, CH2: V_{out} (turn on by OE))

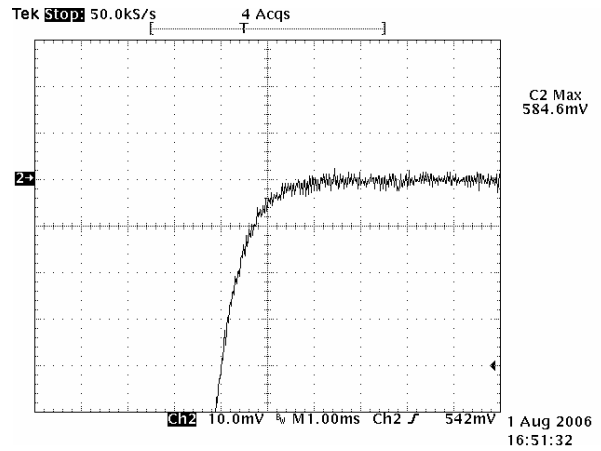

Figure 40: Turn on overshoot
($V_{in}=5V$, $V_{out}=0.59V/10A$, CH2: V_{out} (turn on by OE))

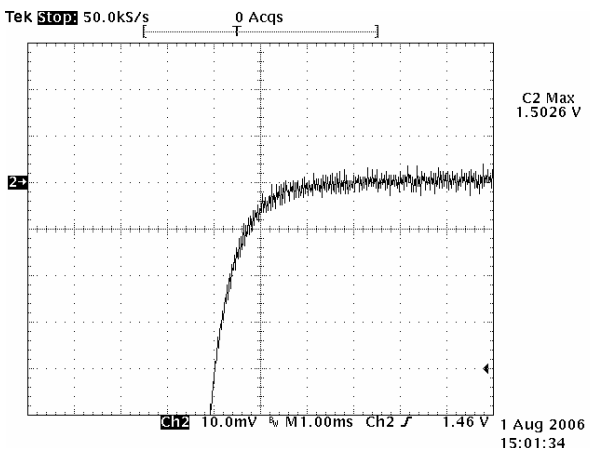

Figure 41: Turn on overshoot
($V_{in}=5V$, $V_{out}=1.5V/10A$, CH2: V_{out} (turn on by OE))

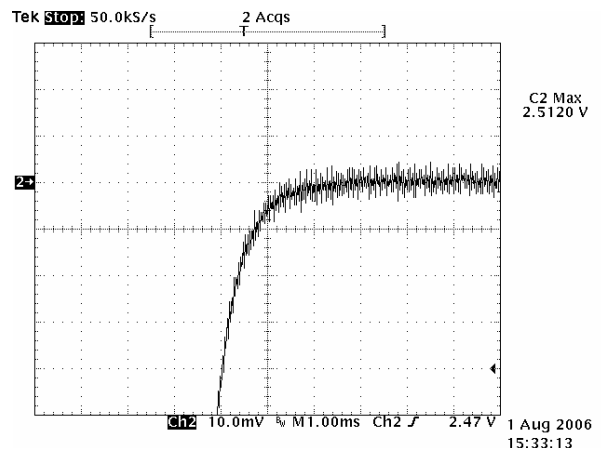

Figure 42: Turn on overshoot
($V_{in}=5V$, $V_{out}=2.5V/10A$, CH2: V_{out} (turn on by OE))



ELECTRICAL CHARACTERISTICS CURVES (CON.)

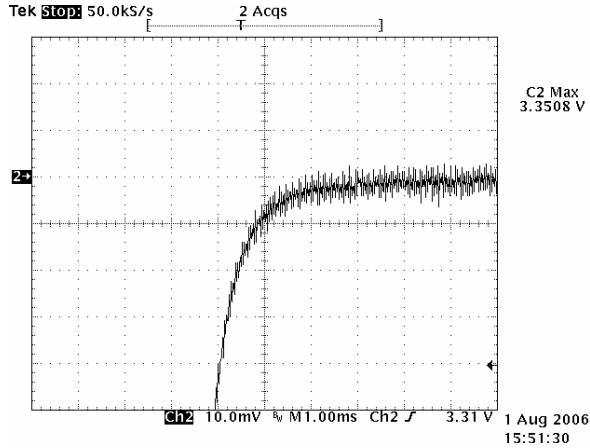

Figure 43: Turn on overshoot
($V_{in}=5V$, $V_{out}=3.3V/10A$, CH2: V_{out} (turn on by OE))

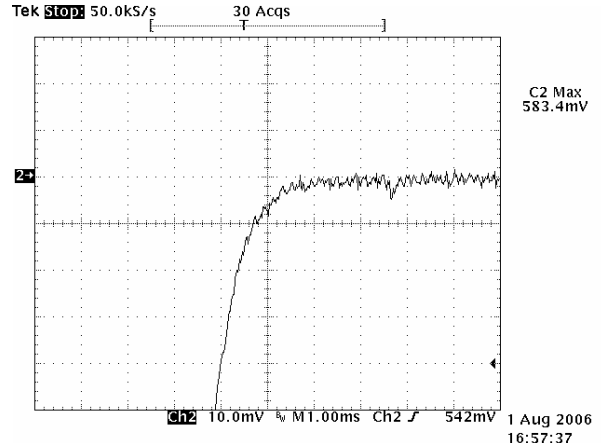

Figure 44: Turn on overshoot
($V_{in}=12V$, $V_{out}=0.59V/10A$, CH2: V_{out} (turn on by OE))

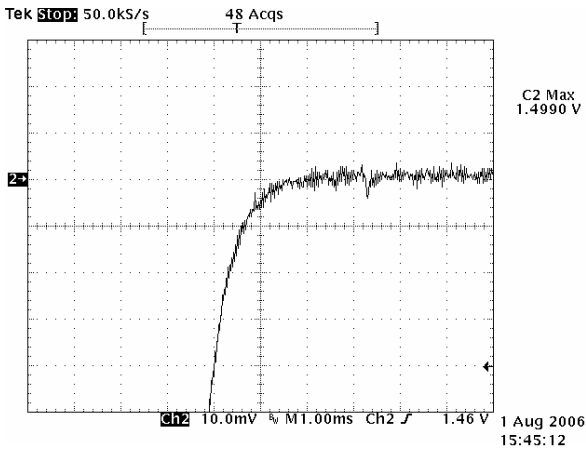

Figure 45: Turn on overshoot
($V_{in}=12V$, $V_{out}=1.5V/10A$, CH2: V_{out} (turn on by OE))

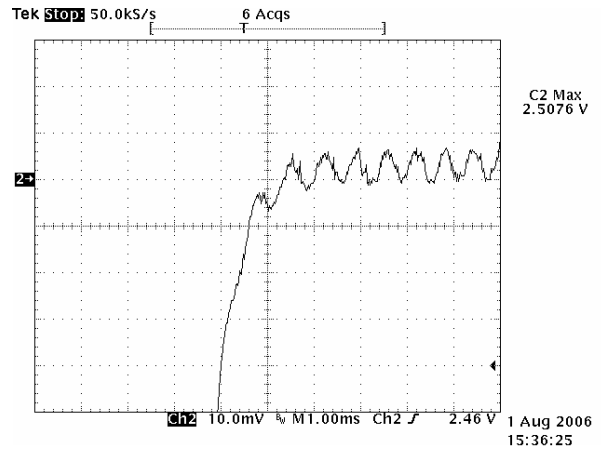

Figure 46: Turn on overshoot
($V_{in}=12V$, $V_{out}=2.5V/10A$, CH2: V_{out} (turn on by OE))

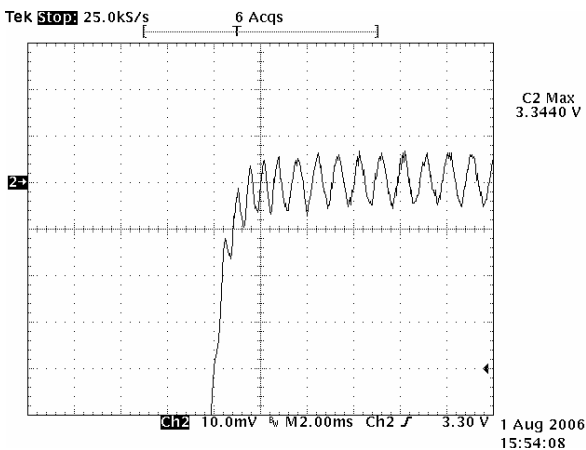

Figure 47: Turn on overshoot
($V_{in}=12V$, $V_{out}=3.3V/10A$, CH2: V_{out} (turn on by OE))

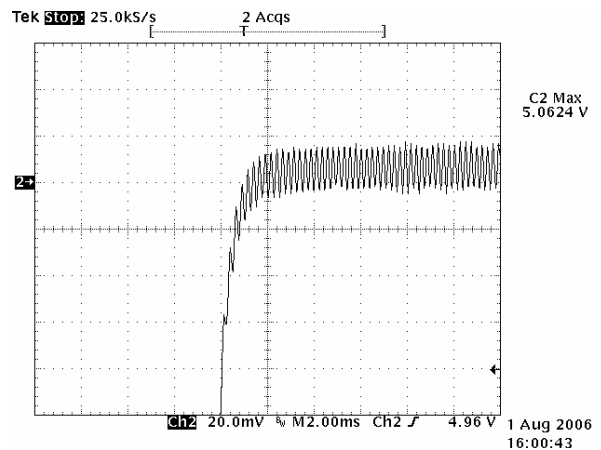

Figure 48: Turn on overshoot
($V_{in}=12V$, $V_{out}=5V/10A$, CH2: V_{out} (turn on by OE))



ELECTRICAL CHARACTERISTICS CURVES (CON.)

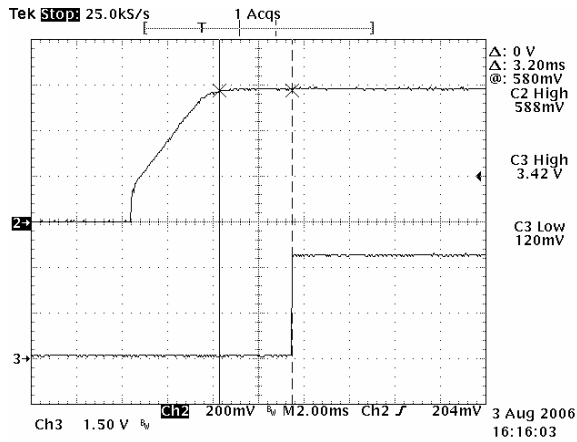

Figure 49: Power Good delay time by on/off
($V_{in}=3.3V$, $V_{out}=0.59V/10A$, CH2: V_{out} , CH3:PG)

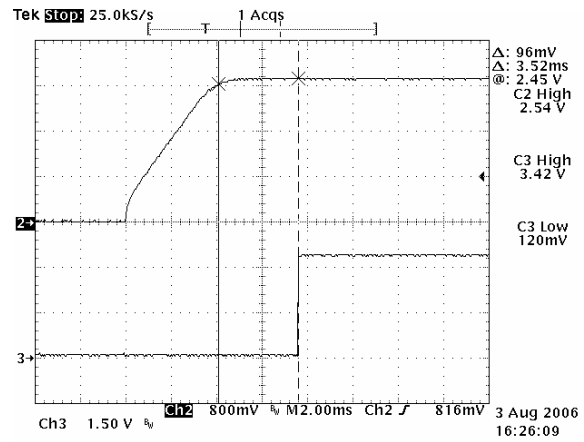

Figure 50: Power Good delay time by on/off
($V_{in}=3.3V$, $V_{out}=2.5V/10A$, CH2: V_{out} , CH3:PG)

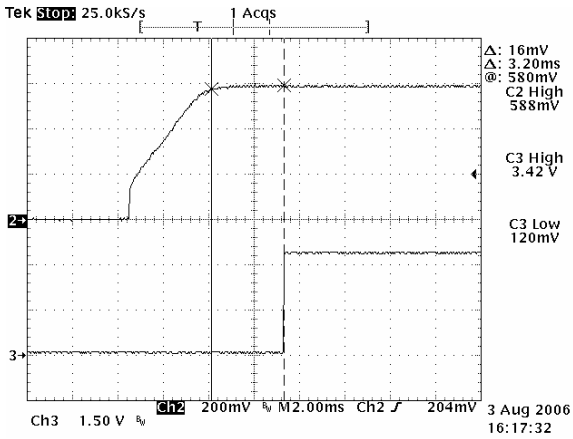

Figure 51: Power Good delay time by on/off
($V_{in}=5V$, $V_{out}=0.59V/10A$, CH2: V_{out} , CH3:PG)

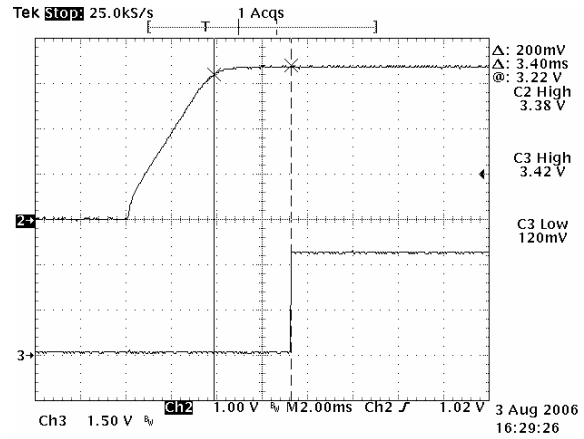

Figure 52: Power Good delay time by on/off
($V_{in}=5V$, $V_{out}=3.3V/10A$, CH2: V_{out} , CH3:PG)

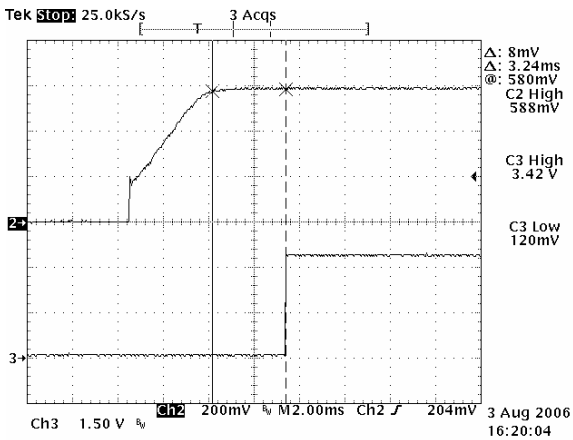

Figure 53: Power Good delay time by on/off
($V_{in}=12V$, $V_{out}=0.59V/10A$, CH2: V_{out} , CH3:PG)

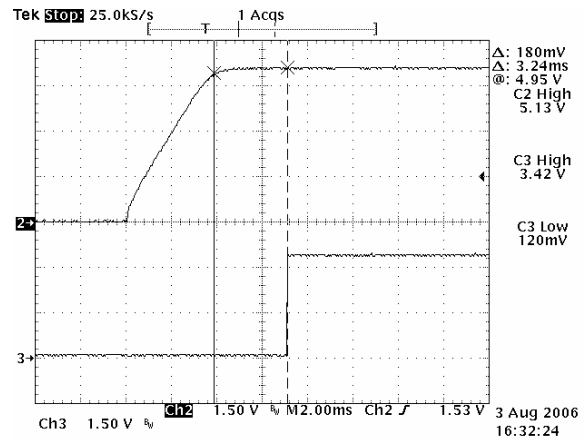

Figure 54: Power Good delay time by on/off
($V_{in}=12V$, $V_{out}=5V/10A$, CH2: V_{out} , CH3:PG)

DESIGN CONSIDERATIONS

The DUS1250Ex is a single phase and voltage mode controlled Buck topology. The output can be trimmed in the range of 0.59Vdc to 5Vdc by a resistor from Trim pin to Ground.

The converter can be turned ON/OFF by remote control with positive on/off (ENABLE pin) logic. The converter DC output is disabled when the signal is driven low (below 0.8V). The module will turn on when this pin is floating and the input voltage is higher than the threshold.

The converter can protect itself by entering hiccup mode against over current and short circuit condition. Also, the converter will shut down when an over voltage protection is detected.

Safety Considerations

It is recommended that the user to provide a very fast-acting type fuse in the input line for safety. The output voltage set-point and the output current in the application could define the amperage rating of the fuse.

Reflected Ripple Current and Output Ripple and Noise Measurement

The measurement set-up outlined in Figure 55 has been used for both input reflected/ terminal ripple current and output voltage ripple and noise measurements on DUS1250Ex series converters.

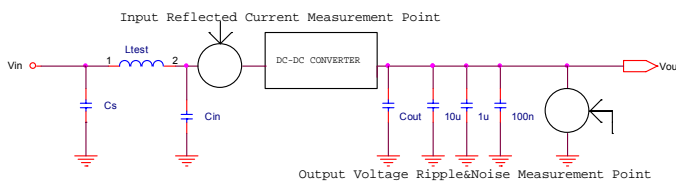

$C_s=270\mu F*1$, $L_{test}=2\mu H$, $C_{in}=270\mu F*1$

Figure 55: Input reflected ripple/ capacitor ripple current and output voltage ripple and noise measurement setup for DUS1250Ex

FEATURES DESCRIPTIONS

Enable (On/Off)

Positive ENABLE is available as standard. The SIP regulator accepts an open collector, open drain signal to enable the output. The SIP regulator pulls the ENABLE signal up to 3.3V or less. When ENABLE is pulled down to 0.4V or less by the host, the SIP regulator will remain off. The host must be able to sink 0.5 mA, minimum, for a logic low.

Power Good

The SIP regulator will provide an open collector Power Good signal. This signal will be open collector and 3.3V compatible. The converter will sink less than 1uA as a logic high and sink at least 1mA as a logic low. A logic low will be less than 0.4V while sinking 1mA. Signal transitions, with a 10K Ohm resistor pulling the output to 3.3V, will be clean (glitch free) and bounce free. The rise/fall time can be no slower than 5usec, measured at 10% and 90% points.

Power Good will transition to the open state between 1 msec and 10 msec of the output voltage reaching its regulation. This signal should transition to low before the output falls out of regulation. Any voltage glitch on Power Good signal is limited to less than 0.4V while the signal is at its high or low state.

Power Good monitors the output voltage. When the output Voltage is within +/-15% of nominal, Power Good will be high. Otherwise, it will be low.

Note to host: Power Good is indeterminate and must be ignored when V_{in} to the SIP is below 3.0V.

FEATURES DESCRIPTIONS (CON.)

Over-Current and Short-Circuit Protection

The DUS1250Ex series modules have non-latching over-current and short-circuit protection circuitry. When over current condition occurs, the module goes into the non-latching hiccup mode. When the over-current condition is removed, the module will resume normal operation.

Vin	Temperature	OCP	Vout					
			0.59V	1.5V	2.5V	3.3V	5.0V	
3.3	25°C	Cold start	15.0	15.0	13.8	/	/	
			Thermal	13.3	13.7	13.6	/	/
		Cold start	17.1	17.3	17.5	18.4	/	
			Thermal	16.0	16.0	16.5	17.4	/
5.0		Cold start	16.9	17.0	16.6	17.2	17.4	
			Thermal	15.4	15.3	14.9	15.0	15.1
3.3		50°C	Cold start	13.9	13.9	13.9	/	/
				Thermal	12.0	12.8	13.7	/
	Cold start		15.7	15.9	16.5	17.1	/	
			Thermal	14.6	14.6	15.3	16.0	/
5.0	Cold start		16.3	15.9	15.8	15.8	16.3	
			Thermal	14.2	13.9	13.8	13.6	13.8

Output Capacitance

There is output capacitor on the DUS1250Ex series modules. Hence, an external output capacitor is not required for stable operation for 0.9V and above. Please see page 2 for minimum output capacitance required for 0.59V to 0.8V output stable operation.

Paralleling

DUS1250Ex converters do not have built-in current sharing (paralleling) ability. Hence, paralleling of multiple DUS1250Ex converters are not recommended.

Output Voltage Programming

The output voltage of the DUS1250Ex series is trimmable by connecting an external resistor between the trim pin and output ground as shown Figure 56 and the typical trim resistor values are shown in Table 1.

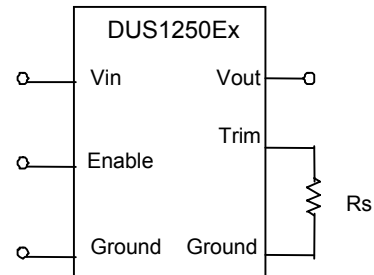

Figure 56: Trimming Output Voltage

The DUS1250Ex module has a trim range of 1.0V to 3.3V. The trim resistor equation for the DUS1250Ex is :

$$R_s(\Omega) = \frac{1180 \text{ DUS1250Ex}}{V_{out} - 0.59}$$

Vout is the output voltage setpoint

Rs is the resistance between Trim and Ground

Rs values should not be less than 240Ω

Output Voltage	Rs (Ω)
0.59V	open
+1.5 V	1.3K
+2.5 V	618
+3.3 V	435
+5.0V	267

Table 1: Typical trim resistor values



THERMAL CONSIDERATION

Thermal management is an important part of the system design. To ensure proper, reliable operation, sufficient cooling of the power module is needed over the entire temperature range of the module. Convection cooling is usually the dominant mode of heat transfer.

Hence, the choice of equipment to characterize the thermal performance of the power module is a wind tunnel.

Thermal Testing Setup

Delta's DC/DC power modules are characterized in heated wind tunnels that simulate the thermal environments encountered in most electronics equipment.

The following figure shows the wind tunnel characterization setup. The power module is mounted on a test PWB and is vertically positioned within the wind tunnel.

Thermal Derating

Heat can be removed by increasing airflow over the module. To enhance system reliability, the power module should always be operated below the maximum operating temperature. If the temperature exceeds the maximum module temperature, reliability of the unit may be affected.

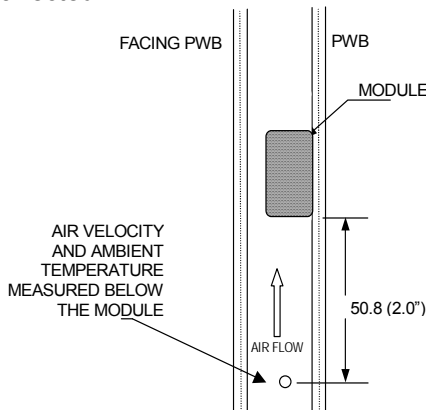

Note: Wind Tunnel Test Setup Figure Dimensions are in millimeters and (Inches)

Note: Wind tunnel test setup figure dimensions are in millimeters and (Inches)

Figure 57: Wind tunnel test setup

THERMAL CURVES (DUS1250EX)

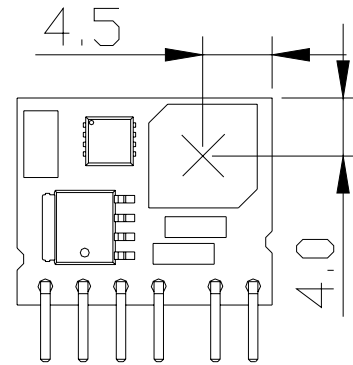

Figure 58: Hot spot temperature measured point (Unit of length is mm)

※The allowed maximum hot spot temperature is defined at 115°C

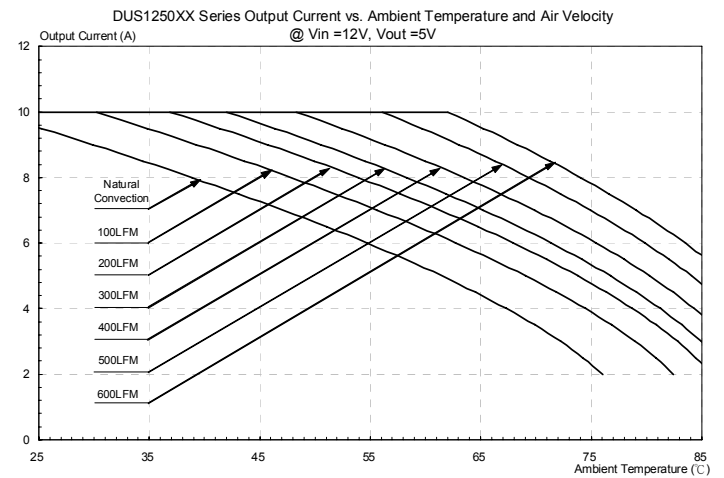

Figure 59: Output current vs. ambient temperature and air velocity @Vin=12V, Vout=5V

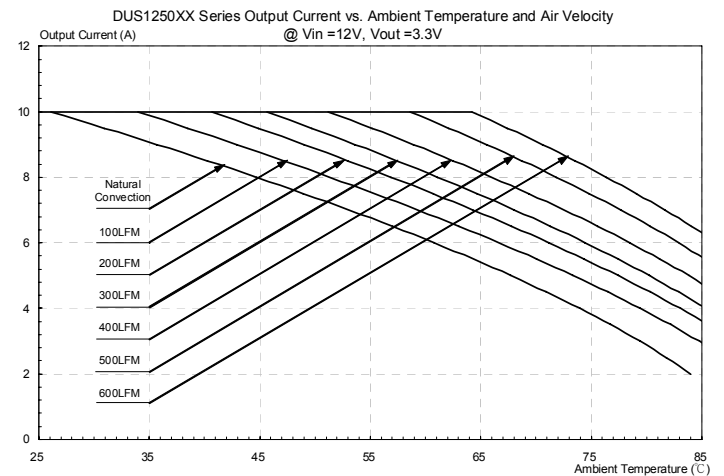

Figure 60: Output current vs. ambient temperature and air velocity @ Vin=12V, Vout=3.3V

THERMAL CURVES (DUS1250EX)

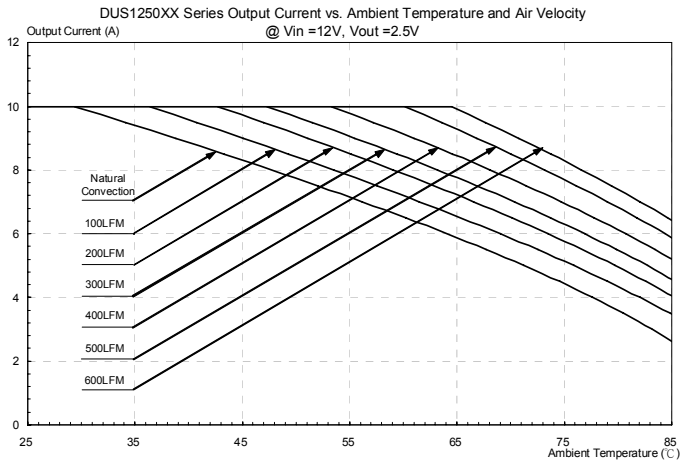

Figure 61: Output current vs. ambient temperature and air velocity @ Vin=12V, Vout=2.5V

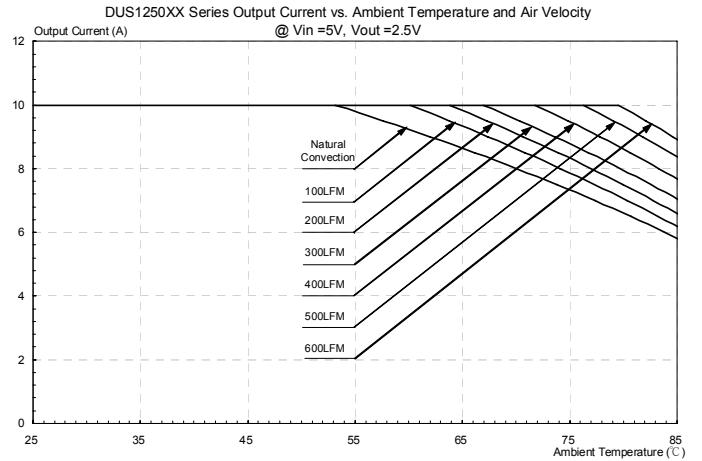

Figure 64: Output current vs. ambient temperature and air velocity @ Vin=5V, Vout=2.5V

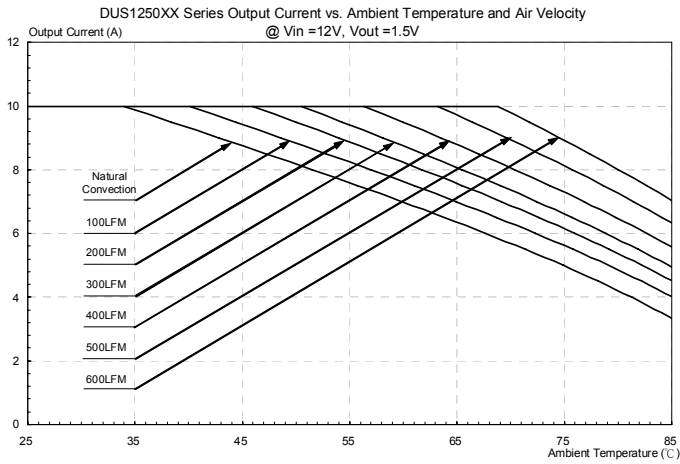

Figure 62: Output current vs. ambient temperature and air velocity @ Vin=12V, Vout=1.5V

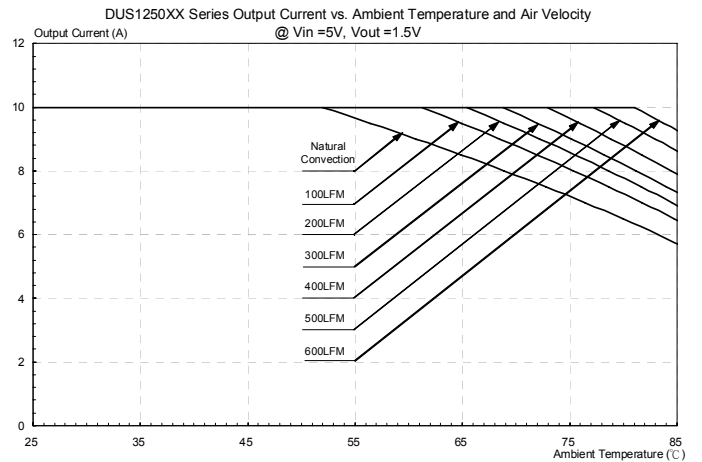

Figure 65: Output current vs. ambient temperature and air velocity @ Vin=5V, Vout=1.5V

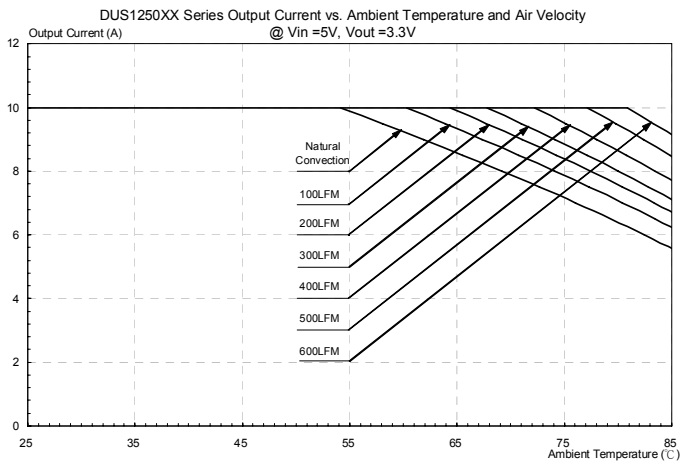
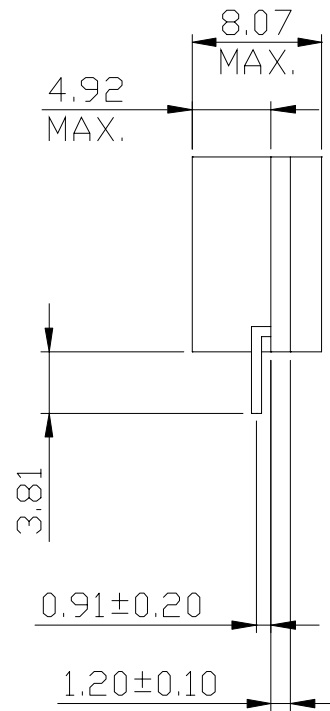
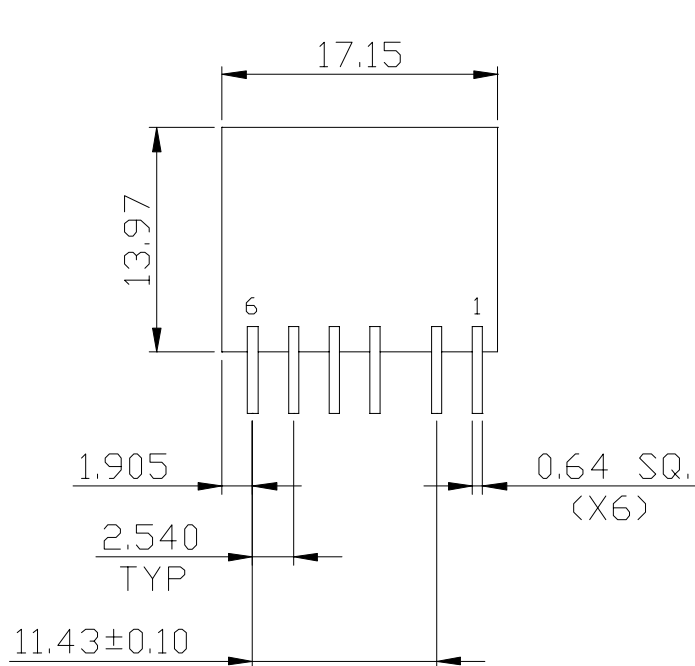
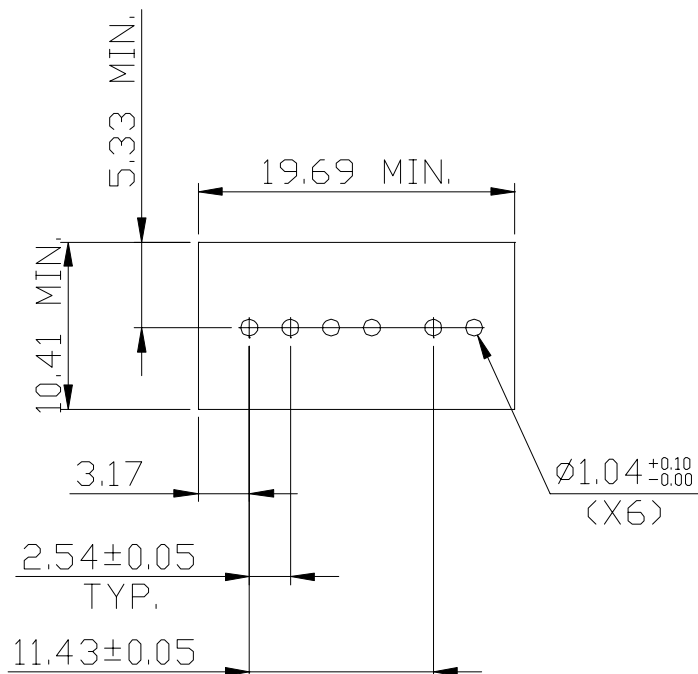

Figure 63: Output current vs. ambient temperature and air velocity @ Vin=5V, Vout=3.3V

MECHANICAL DRAWING



SUGGEST LAYOUT AREA



PIN ASSIGNMENT

PIN	FUNCTION
1	Vout
2	Trim
3	GND
4	PG
5	EN
6	Vin



MODEL LIST

Model Name	Lead Free Comparable	Input Voltage	Output Voltage	Output Current
DUS1250EF	RoHs 5	2.97V~ 13.2V	0.59V~5V	10A
DUS1250EG	RoHs 6	2.97V~ 13.2V	0.59V~5V	10A

CONTACT: www.delta.com.tw/dcdc

USA:

Telephone:
East Coast: (888) 335 8201
West Coast: (888) 335 8208
Fax: (978) 656 3964
Email: DCDC@delta-corp.com

Europe:

Telephone: +41 31 998 53 11
Fax: +41 31 998 53 53
Email: DCDC@delta-es.tw

Asia & the rest of world:

Telephone: +886 3 4526107 ext. 6220
Fax: +886 3 4513485
Email: DCDC@delta.com.tw

WARRANTY

Delta offers a two (2) year limited warranty. Complete warranty information is listed on our web site or is available upon request from Delta.

Information furnished by Delta is believed to be accurate and reliable. However, no responsibility is assumed by Delta for its use, nor for any infringements of patents or other rights of third parties, which may result from its use. No license is granted by implication or otherwise under any patent or patent rights of Delta. Delta reserves the right to revise these specifications at any time, without notice.