

The power behind competitiveness

Delta UPS - Ultron Family

DPS Series, Three Phase
160/ 200 kVA

User Manual

Save This Manual

This manual contains important instructions and warnings that you should follow during the installation, operation, storage and maintenance of this product. Failure to heed these instructions and warnings will void the warranty.

Copyright © 2018 by Delta Electronics Inc. All Rights Reserved. All rights of this User Manual ("Manual"), including but not limited to the contents, information, and figures are solely owned and reserved by Delta Electronics Inc. ("Delta"). The Manual can only be applied to the operation or the use of this product. Any disposition, duplication, dissemination, reproduction, modification, translation, extraction, or usage of this Manual in whole or in part is prohibited without the prior written permission of Delta. Given that Delta will continuously improve and develop the product, changes may be made to the information in this Manual at any time without obligation to notify any person of such revision or changes. Delta will make all possible efforts to secure the accuracy and the integrity of this Manual. Delta disclaims any kinds or forms of warranty, guarantee, or undertaking, either expressly or implicitly, including but not limited to the completeness, faultlessness, accuracy, non-infringement, merchantability or fitness for a particular purpose of the Manual.

Table of Contents

| | | |
|-----------|---|------------|
| 1. | Important Safety Instructions | 1-1 |
| 1.1 | Installation Warnings | 1-2 |
| 1.2 | Connection Warnings | 1-2 |
| 1.3 | Usage Warnings | 1-3 |
| 1.4 | Storage Warnings | 1-4 |
| 1.5 | Glossary of Symbols | 1-5 |
| 1.6 | Standard Compliance | 1-6 |
| 2. | Introduction | 2-1 |
| 2.1 | General Overview | 2-2 |
| 2.2 | Package Inspection | 2-2 |
| 2.3 | Functions & Features | 2-3 |
| 2.4 | Exterior | 2-5 |
| 2.4.1 | Mechanism Data | 2-5 |
| 2.4.2 | Other Views | 2-6 |
| 2.5 | Control Panel | 2-7 |
| 2.5.1 | LED Indicators | 2-7 |
| 2.5.2 | ON, OFF, and EPO Buttons | 2-8 |
| 2.5.3 | LCD Display | 2-8 |
| 2.5.4 | Function Keys | 2-9 |
| 2.6 | Internal Mechanisms | 2-9 |
| 2.6.1 | Input & Output Switches | 2-9 |
| 2.6.2 | Auxiliary Power Fuse and AC Outlet Fuse | 2-10 |
| 2.6.3 | Wiring Terminal Block | 2-11 |
| 2.6.4 | Communication Interfaces | 2-13 |
| 2.7 | Fans | 2-14 |
| 3. | Operation Modes | 3-1 |
| 3.1 | Normal Mode (Single) | 3-2 |
| 3.2 | Battery Mode (Single) | 3-3 |

| | | |
|-----------|--|------------|
| 3.3 | Bypass Mode (Single) | 3-4 |
| 3.4 | Manual Bypass Mode (Single) | 3-5 |
| 3.5 | ECO Mode | 3-6 |
| 3.6 | Normal Mode (Parallel) | 3-7 |
| 3.7 | Battery Mode (Parallel) | 3-8 |
| 3.8 | Bypass Mode (Parallel) | 3-9 |
| 3.9 | Manual Bypass Mode (Parallel) | 3-10 |
| 3.10 | Common Battery | 3-11 |
| 4. | Communication Interfaces | 4-1 |
| 4.1 | Smart Slots | 4-2 |
| 4.2 | RS-232 Port & USB Port | 4-3 |
| 4.3 | Dry Contacts | 4-3 |
| 4.4 | Parallel Ports | 4-5 |
| 4.5 | Parallel Switch | 4-5 |
| 4.6 | Output Dry Contacts | 4-5 |
| 5. | Installation and Wiring | 5-1 |
| 5.1 | Before Installation | 5-2 |
| 5.2 | Installation Environment | 5-2 |
| 5.3 | Transportation | 5-3 |
| 5.4 | Fixing the UPS | 5-4 |
| 5.5 | Wiring | 5-6 |
| 5.5.1 | Pre-wiring Warnings | 5-6 |
| 5.5.2 | Single Input/ Dual Input Modification | 5-8 |
| 5.5.3 | Single Unit Wiring | 5-10 |
| 5.5.4 | Parallel Unit Wiring | 5-14 |
| 5.6 | External Battery Cabinet Connection Warnings | 5-17 |
| 6. | UPS Operation | 6-1 |
| 6.1 | Single Unit Operation Procedures | 6-2 |
| 6.1.1 | Normal Mode Start-up Procedures (Single) | 6-3 |

| | | |
|-----------|---|------------|
| 6.1.2 | Battery Mode Start-up Procedures (Single) ----- | 6-5 |
| 6.1.3 | Bypass Mode Start-up Procedures (Single) ----- | 6-6 |
| 6.1.4 | Manual Bypass Mode Start-up Procedures (Single Unit)----- | 6-7 |
| 6.1.5 | Normal Mode Turn-off Procedures (Single) ----- | 6-10 |
| 6.1.6 | Battery Mode Turn-off Procedures (Single) ----- | 6-11 |
| 6.1.7 | Bypass Mode Turn-off Procedures (Single) ----- | 6-12 |
| 6.1.8 | Manual Bypass Mode Turn-off Procedure (Single)----- | 6-13 |
| 6.2 | Parallel Units Operation Procedures ----- | 6-13 |
| 6.2.1 | Normal Mode Start-up Procedures (Parallel) ----- | 6-15 |
| 6.2.2 | Battery Mode Start-up Procedures (Parallel) ----- | 6-17 |
| 6.2.3 | Bypass Mode Start-up Procedures (Parallel) ----- | 6-18 |
| 6.2.4 | Manual Bypass Mode Start-up Procedures (Parallel) ----- | 6-19 |
| 6.2.5 | Normal Mode Turn-off Procedures (Parallel) ----- | 6-24 |
| 6.2.6 | Battery Mode Turn-off Procedures (Parallel)----- | 6-27 |
| 6.2.7 | Bypass Mode Turn-off Procedures (Parallel) ----- | 6-29 |
| 6.2.8 | Manual Bypass Mode Turn-off Procedure (Parallel) ----- | 6-29 |
| 7. | LCD Display & Settings ----- | 7-1 |
| 7.1 | LCD Display Hierarchy----- | 7-2 |
| 7.2 | LCD Display & Function Keys----- | 7-3 |
| 7.3 | Password Entry ----- | 7-4 |
| 7.4 | Main Screen ----- | 7-5 |
| 7.5 | Main Menu ----- | 7-8 |
| 7.6 | Check System Readings ----- | 7-9 |
| 7.7 | UPS Configurations----- | 7-10 |
| 7.7.1 | Bypass setup----- | 7-10 |
| 7.7.2 | Output Setup ----- | 7-10 |
| 7.7.3 | Battery Setup----- | 7-11 |
| 7.7.4 | Charger Setup ----- | 7-12 |
| 7.7.5 | Parallel Setup ----- | 7-13 |
| 7.7.6 | Test, Buzzer and LED Setup, and Module Reset----- | 7-14 |
| 7.7.7 | Local Setup----- | 7-15 |

| | | |
|------------|--|-------------|
| 7.7.8 | Dust Filter Setup | 7-16 |
| 7.8 | System Maintenance | 7-17 |
| 7.8.1 | Check/ Clear Event Log | 7-17 |
| 7.8.2 | Check/ Clear Statistics | 7-18 |
| 7.8.3 | Check/ Upgrade Firmware | 7-19 |
| 7.8.4 | Force Bypass to Inverter | 7-20 |
| 7.8.5 | Others | 7-21 |
| 8. | Optional Accessories | 8-1 |
| 9. | Maintenance | 9-1 |
| 10. | Troubleshooting | 10-1 |
| | Appendix 1 : Technical Specifications | A1-1 |
| | Appendix 2 : Warranty | A2-1 |

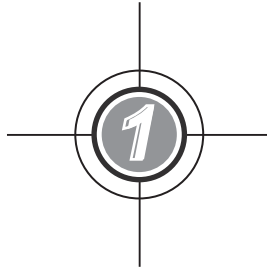

Important Safety Instructions

1.1 Installation Warnings

1.2 Connection Warnings

1.3 Usage Warnings

1.4 Storage Warnings

1.5 Glossary of Symbols

1.6 Standard Compliance

1.1 Installation Warnings

- This is a three-phase four-wire on-line UPS. It can be used for commercial and industrial applications.
- Install the UPS in a well-ventilated indoor area, away from excess moisture, heat, dust, flammable gas or explosives.
- Leave adequate space around all sides of the UPS for proper ventilation and maintenance. Please refer to **5.2 Installation Environment**.
- Only authorized Delta engineers or service personnel can perform installation and maintenance. If you want to install the UPS by yourself, please install it under the supervision of authorized Delta engineers or service personnel
- Follow the IEC 60364-4-42 standard to install the UPS.

1.2 Connection Warnings

- Before applying electrical power to the UPS, make sure the UPS is grounded to avoid a possible risk of current leakage.
- The installation of protective devices is highly recommended when the UPS is connected to power sources and critical loads.
- The protective devices connecting to the UPS must be installed near the UPS and must be easily accessible for operation.
- Protective Devices:
 1. It is suggested that you install appropriate protective devices between the UPS and input AC power. The protective devices should have the functions of over current protection, short circuit protection (160 kVA: cut-off current less than 5kA; 200 kVA: cut-off current less than 9kA), insulating protection and shunt trip feature.
 2. When you select the protective devices, please take each power cable's current capacity and the system's overload capacity (please refer to **Appendix 1: Technical Specifications**) into consideration. Besides, the short-circuit capacity of the upstream protective devices must be equal to or higher than the capacity of the UPS's input protective devices.
 3. For single input, when the UPS has abnormalities and input short current reaches 20kA, the UPS's internal semi-conductor fast-acting fuses need 8ms ~10ms to be fused. Thus, the upstream protective devices' reaction time should be more than 10ms to let the UPS's internal protective devices block breakdown and let the UPS transfer to bypass mode.
 4. For dual input, please install the protective devices between the UPS and the main AC source, and also install the protective devices between the UPS and the bypass source.

1.3 Usage Warnings

- The UPS can be used to power computers and associated peripheral devices, such as monitors, modems, cartridge tape drives, external hard drives, etc. If you want to connect inductive or capacitive loads to the UPS, it needs derating. Please contact Delta service personnel for derating information.
- The external slits and openings in the UPS are provided for ventilation. To ensure reliable operation of the UPS and to protect the UPS from overheating, these slits and openings must not be blocked or covered. Do not insert any object into the slits and openings that may hinder ventilation.
- Before usage, you must allow the UPS to adjust to room temperature (20°C~25°C) for at least one hour to avoid moisture condensing inside the UPS.
- Do not put beverages on the UPS, battery cabinet or any other accessory associated with the UPS.
- Do not open or remove the cover of the UPS to avoid high voltage electric shock. Only authorized Delta engineers or service personnel can do so for installation or maintenance. If you want to open or remove the cover, do it only under the supervision of authorized Delta engineers or service personnel.
- It is strictly forbidden to connect the UPS to the following loads:
 1. Regenerative loads
 2. Asymmetrical loads (ex. half-wave rectifier)
- If the UPS is supplied by a source whose neutral is grounded, the backfeed protective device installed as UPS input protection must be a 3-pole type. If the UPS is supplied by a source whose neutral is not grounded, the backfeed protective device installed as UPS input protection must be a 4-pole type.
- The recommended electrical rating of the backfeed protective device is:

| 160kVA | 200kVA |
|------------|------------|
| 690V/ 320A | 690V/ 400A |

- The risk of dangerous high voltage is possible when batteries are still connected to the UPS even though the UPS is disconnected from AC power sources. Before maintenance, please turn off the external battery cabinet's circuit breaker to cut off the battery power from the UPS.
- Do not dispose of the battery or batteries in a fire. The batteries may explode.
- Do not open or damage the battery or batteries. The released electrolyte is harmful to the skin and eyes and may be toxic.

- The UPS is electronic equipment that runs 24 hours continuously. To ensure its normal life-time, regular maintenance of the UPS and batteries is of vital importance and necessary.
- Some components like batteries, power capacitors, and fans will become worn-out due to long-term usage, and this will increase the risk of UPS failure. To replace and maintain the components, please contact Delta customer service department.
- A battery can present a risk of electric shock and high short-circuit current. The following precautions should be observed before replacement of batteries:
 1. Remove watches, rings, or other metal objects.
 2. Use tools with insulated handles.
 3. Wear insulating gloves and boots.
 4. Do not lay tools or metal parts on the top of batteries.
 5. Disconnect the charging source prior to connecting or disconnecting the batteries' terminals.
- You must contact Delta customer service department if either of the following events occur:
 1. Liquid is poured or splashed on the UPS.
 2. The UPS does not run normally after carefully following the instructions in this User Manual.





















NOTE: If you use the UPS in an area that generates or incurs dust, you should install dust filters in the UPS to ensure product life and function.

1.4 Storage Warnings

- Use the original packing material to pack the UPS to prevent any possible damage from rodents.
- If the UPS needs to be stored prior to installation, it should be placed in a dry indoor area. The allowable storage temperature is between -20°C ~ 70°C and relative humidity is below 95%.

1.5 Glossary of Symbols

| No. | Symbol | Description |
|-----|--|---|
| 1 | R | R-phase |
| 2 | S | S-phase |
| 3 | T | T-phase |
| 4 | N | Neutral |
| 5 |  | Grounding (Protective earthing conductor) |
| 6 |  | Bonded to ground |
| 7 | + | Positive battery terminal |
| 8 | - | Negative battery terminal |
| 9 |  | ON button |
| 10 |  | OFF button |
| 11 |  | EPO button |
| 12 | ~ | Main AC Source LED |
| 13 | ~ | Bypass AC Source LED |
| 14 |  | Inverter Start-up LED |
| 15 |  | Inverter Power Supply LED |
| 16 |  | Bypass Power Supply LED |
| 17 |  | Battery Power Supply LED |
| 18 |  | Output Switch LED |
| 19 | Fault  | Fault LED |
| 20 |  | Battery low |
| 21 |  | Battery normal |
| 22 |  | DC to AC conversion |
| 23 |  | AC to DC conversion |
| 24 |  | DC to DC conversion |
| 25 |  | Bypass AC source |
| 26 |  | Main AC source |
| 27 |  | Output |

| No. | Symbol | Description |
|-----|--------|--|
| 28 | | Input Switch/ Bypass Switch/ Manual Bypass Switch/ Output Switch is in the OFF position. |
| 29 | | Static Switch is in the OFF position. |
| 30 | | Input Switch/ Bypass Switch/ Manual Bypass Switch/ Output Switch/ Static Switch is in the ON position. |
| 31 | | Parallel cable is abnormal. |
| 32 | | Parallel cable connected. |
| 33 | | Bypass frequency unstable. |
| 34 | | Battery test cannot be executed. |
| 35 | | Cursor |
| 36 | | When the symbol changes to the symbol , it means that you can change your selected item's setting. |
| 37 | | Flashes when an alarm/ event occurs. |
| 38 | | Goes back to previous screen or cancels current selection. |
| 39 | | Moves up. |
| 40 | | Moves down. |
| 41 | | Moves left. |
| 42 | | Moves right. |
| 43 | | Increases number. |
| 44 | | Decreases number. |
| 45 | | Confirms selection. |

1.6 Standard Compliance

- EN 62040-1
- EN 62040-2 C3
- IEC 61000-4-2 Level 4
- IEC 61000-4-3 Level 3
- IEC 61000-4-4 Level 4
- IEC 61000-4-5 Level 4
- IEC 61000-4-6

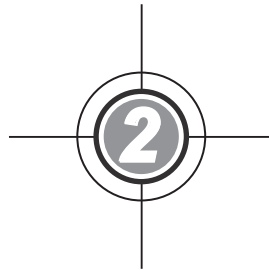

Introduction

2.1 General Overview

2.2 Package Inspection

2.3 Functions & Features

2.4 Exterior

2.5 Control Panel

2.6 Internal Mechanisms

2.7 Fans

2.1 General Overview

The DPS series UPS, a three-phase four-wire on-line uninterruptible power supply, is a dedicated design for large scale power systems such as data centers, communication systems, network rooms, emergency systems and factory facilities. The unit adopts advanced IGBT technology to provide perfect, clean, pure sine waves and high-quality output power to the critical loads connected. It features high efficiency, low heat generation, low noise, and high reliability.

Using the RS-232 port, you can connect the UPS to a PC to monitor relevant issues. With the installation of the included software CD-UPSentry 2012, you can monitor several UPSs placed in a computer room or a factory to facilitate centralized control. Besides, you can parallel at maximum eight UPS units without using any external parallel card to increase the system capacity and redundancy and enhance the unit's availability and reliability.

2.2 Package Inspection

- **External**

During UPS transportation, some unpredictable situations might occur. It is recommended that you inspect the UPS exterior packaging. If you notice any damage, please immediately contact the dealer from whom you purchased the unit.

- **Internal**

1. Check the rating label attached to the UPS and make sure the device No. and capacity match what you ordered.
2. Examine if any parts are loose or damaged.
3. The UPS package contains the following items. Please check if any items are missing.

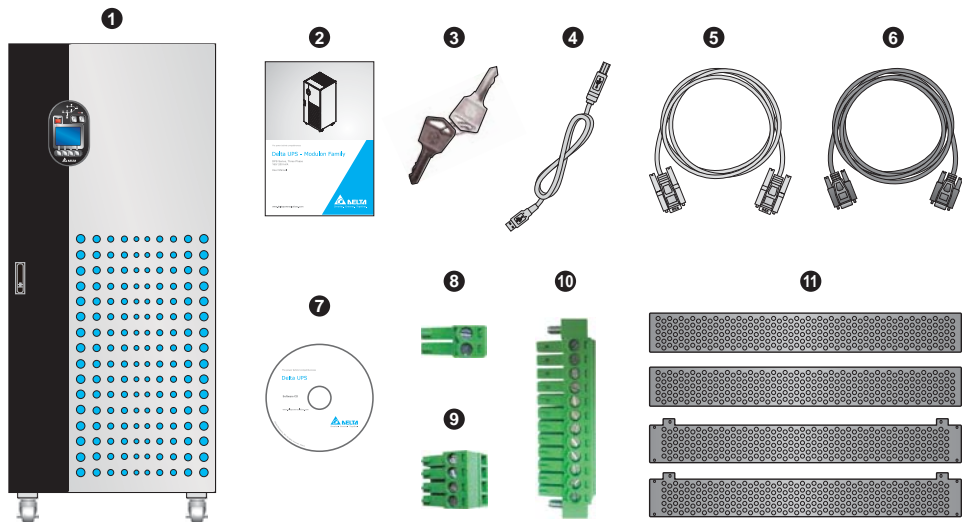

| No. | Item | Quantity |
|-----|-----------------------------------|---|
| ① | UPS | 1 pc |
| ② | User Manual | 1 pc |
| ③ | Key | 1 pc (two copies placed inside the UPS cabinet) |
| ④ | USB Cable | 1 pc |
| ⑤ | RS-232 Cable | 1 pc (1.8-meter long) |
| ⑥ | Parallel Cable | 1 pc (5-meter long) |
| ⑦ | Software CD-UPSentry 2012 | 1 pc |
| ⑧ | REPO Dry Contact Terminal Block | 1 set (2-Pin) |
| ⑨ | Input Dry Contact Terminal Block | 1 set (4-Pin) |
| ⑩ | Output Dry Contact Terminal Block | 1 set (12-Pin) |
| ⑪ | Rodent Shield | 1 set (4 pcs) |

4. If there is any damage or anything missing, please immediately contact the dealer from whom you purchased the unit.
5. If the UPS needs to be returned, carefully repack the UPS and all of the accessories using the original packing material that came with the unit.

2.3 Functions & Features

- True on-line double-conversion design UPS adopts DSP chip and IGBT technology to protect your sensitive electronic equipment from power interruption.
- Input power factor > 0.99 and input THDi < 3% save on installation cost and diminish power contamination.
- Efficiency > 96% saves on operation cost.
- Wide AC input voltage range (140Vac~276Vac) reduces frequent transfer from normal mode to battery mode to save battery consumption and prolong battery life.
- Batteries power on the UPS to provide stable AC power when there is no AC line available.
- Automatic input frequency detection enables operation at 50Hz or 60Hz.
- Optional ECO Mode: when input voltage and frequency are within the range of rating voltage $\pm 10\%$ and rating frequency $\pm 5\text{Hz}$, the UPS will transfer to bypass mode; otherwise, the UPS will transfer to normal mode to reach higher efficiency.

- Automatically detects whether bypass voltage is out of rating voltage. If yes, the UPS will stop supplying power to the critical loads to protect your electronic equipment.
- Dual-input design features an independent rectifier and a bypass switch.
- Built-in manual bypass switch.
- Automatic Restart
 1. The UPS will restart in normal mode automatically right after the AC line resumes following a low battery shutdown.
 2. The UPS returns automatically to normal mode from bypass mode after an overload condition or a short circuit condition is cleared.
- Surge protection and EMI filter functions.
- Both auxiliary power and control circuit adopt redundancy design, which doubly enhances UPS reliability.
- Connects several external battery cabinets (at maximum four) to extend backup time.
- Sets up battery test and battery replacement alarms.
- Smart battery charger design allows auto-charging or manual-charging to reduce charging time.
- Local and remote emergency power off functions.
- Attaches optional accessories like SNMP, Relay I/O, and MODBUS cards for network communication, dry contact, and MODBUS communication.
- Built-in RS-232 port allows monitoring and management of the UPS via the UPSentry 2012 software (<http://www.deltapowersolutions.com/en/mcis/software-center.php>).
- State-of-the-art microprocessor technology performs self-detection and displays the UPS status on LCD.
- Built-in SRAM records at maximum 500 event logs.
- Fans automatically adjust fan speed to prolong fan life and reduce noise when the critical loads decrease.
- AC start-up function even when the UPS is not connected to the batteries.



WARNING:

Please note that when the UPS is not connected to the batteries, it will not protect your equipment if the utility power is lost.

2.4 Exterior

On the front of the UPS, there is a control panel and a lockable door switch. On the top, there are fans to ventilate the UPS to prevent overheating. At the bottom, four casters are designed to move the UPS for short distances, and four levelers fix the UPS to the floor.

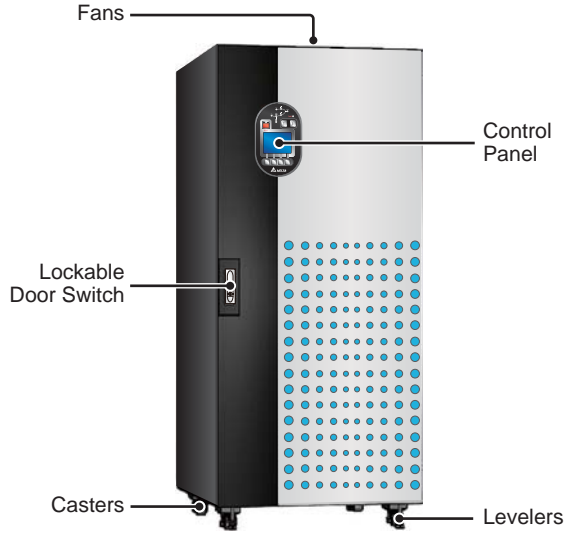

(Figure 2-1: UPS Exterior)

2.4.1 Mechanism Data

| DPS Series UPS Dimensions Table | | | |
|---------------------------------|------------|------------|-------------|
| Rating | Width (mm) | Depth (mm) | Height (mm) |
| 160kVA/ 200kVA | 850 | 865 | 1950 |

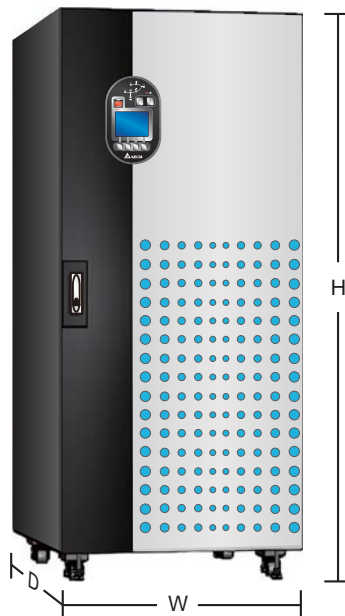

(Figure 2-2: Dimensions)

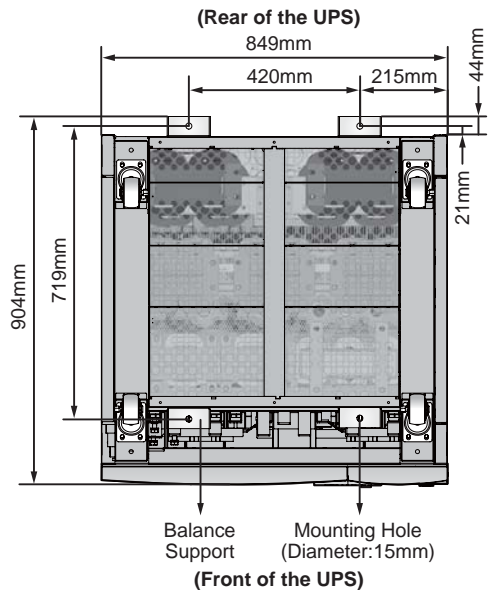

(Figure 2-3: Bottom View & Mounting Hole Diagram)

2.4.2 Other Views

- **Front view:** control panel, door handle, casters, and levelers (see **Figure 2-1**).
- **Open door view:** open front door (see **Figure 2-4**).
- **Front view with door open:** internal mechanisms (see **Figure 2-5**).

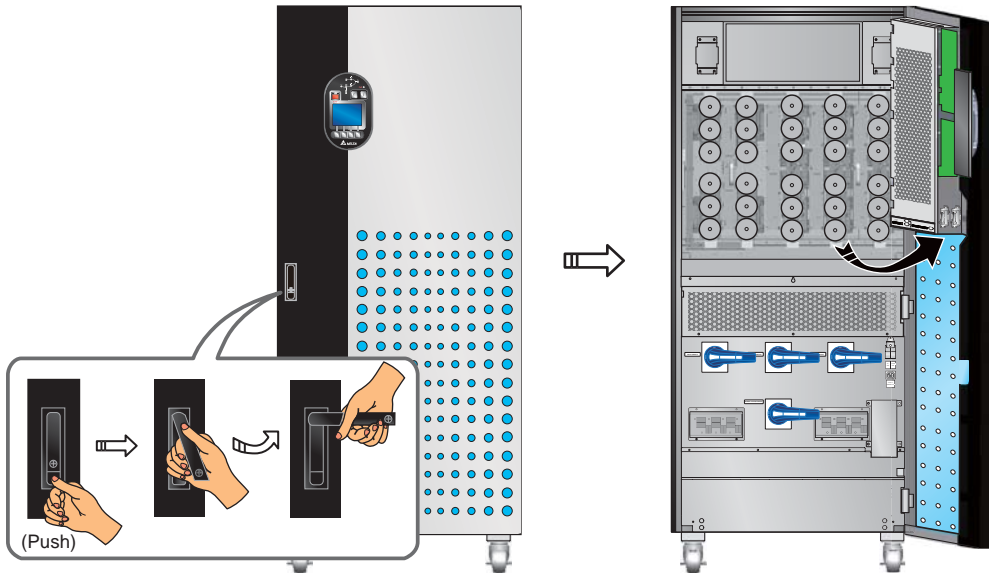

(Figure 2-4: Front View & Door Handle)

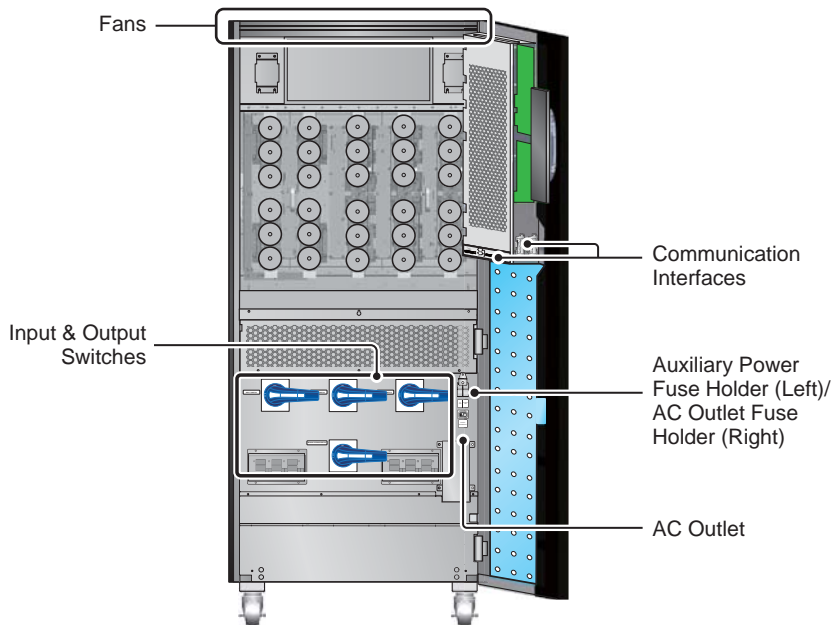

(Figure 2-5: Internal Mechanisms)

2.5 Control Panel

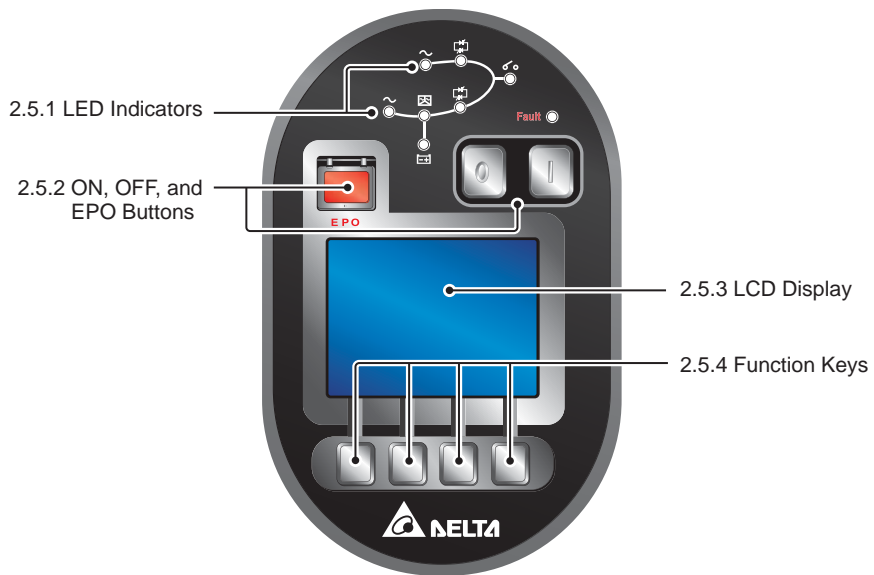

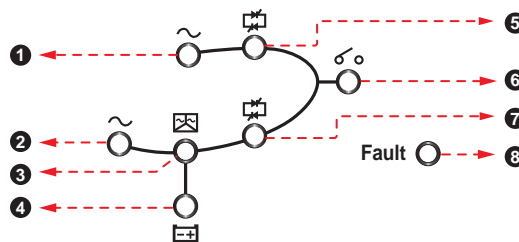

(Figure 2-6: UPS Control Panel)

2.5.1 LED Indicators





(Figure 2-7: LED Indicators)

| No. | LED Symbol | Indicates | LED On | Meaning |
|-----|------------|----------------------|--------|---|
| ① | ~ | Bypass AC Source | Green | When bypass AC Source is normal. |
| ② | ~ | Main AC Source | Green | When main AC Source is normal. |
| ③ | ⊠ | Inverter Start-up | Green | When the UPS's inverter starts up. |
| ④ | ⊠+ | Battery Power Supply | Yellow | When batteries supply power to the critical loads. |
| ⑤ | ⊠* | Bypass Power Supply | Yellow | When the bypass supplies power to the critical loads. |

| No. | LED Symbol | Indicates | LED On | Meaning |
|-----|--|-----------------------|--------|---|
| 6 |  | Output Switch | Green | When you turn on the Output Switch (Q4). |
| 7 |  | Inverter Power Supply | Green | When the inverter supplies power to the critical loads. |
| 8 | Fault  | Fault | Red | When problems occur. |

2.5.2 ON, OFF, and EPO Buttons

| Button | Name | Function |
|---|------------|---|
|  | ON Button | Press this button for three to ten seconds and release it after you hear one beep to start the UPS. If you do not release this button within ten seconds, the UPS will not start. |
|  | OFF Button | <p>Press this button for three to ten seconds, release it after you hear one beep and the system will show the message below.</p> <div style="text-align: center; border: 1px solid black; padding: 5px; width: fit-content; margin: 10px auto;"> SHUTDOWN UPS? YES NO </div> <p>Select 'YES' to turn off the UPS (the inverter will off). If you select 'YES' and the system detects there is a risk of power interruption during transfer from inverter to bypass, the UPS will show the following message.</p> <div style="text-align: center; border: 1px solid black; padding: 5px; width: fit-content; margin: 10px auto;"> RISK OF LOAD DROP! SHUTDOWN UPS? YES NO </div> <p>To confirm turning off the UPS, select 'YES' again. Please see 7. LCD Display and Settings for control panel operation.</p> |
|  | EPO Button | When an emergency occurs, press this button to shut down the UPS rectifier, inverter and output. |

2.5.3 LCD Display

The UPS supports multi-language LCD display. The language default setting is English. If you wish to change the language default setting, please refer to **7.7.7 Local Setup**.



NOTE: The language default setting may be different according to countries.

2.5.4 Function Keys

There are no symbols on the function keys. The functions of keys depend on symbols appearing on the LCD. Please see the table below.

| No. | Symbol | Function |
|-----|--------|--|
| 1 | ↻ | Goes back to previous screen or cancels current selection. |
| 2 | ▲ | Moves up. |
| 3 | ▼ | Moves down. |
| 4 | ◀ | Moves left. |
| 5 | ▶ | Moves right. |
| 6 | + | Increases number. |
| 7 | - | Decreases number. |
| 8 | ⏏ | Confirms selection or goes to Main Menu. |

2.6 Internal Mechanisms

2.6.1 Input & Output Switches

The input and output switches include Input Switch (Q1), Bypass Switch (Q2), Manual Bypass Switch (Q3) and Output Switch (Q4). Each switch has a switch and fuses.

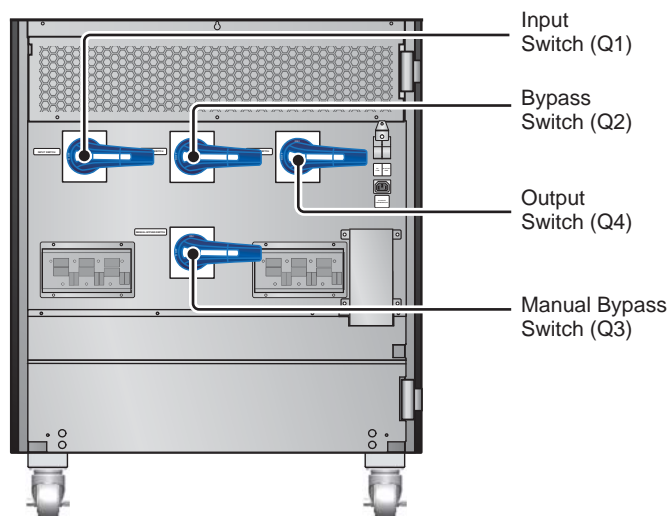

(Figure 2-8: Input & Output Switches)

Please see the following figure to turn on/ off a switch.

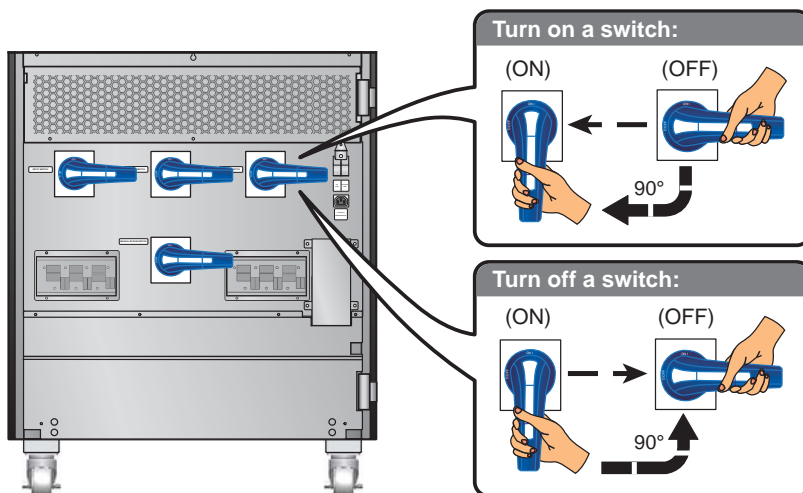

(Figure 2-9: Turn on/ off a Switch)

2.6.2 Auxiliary Power Fuse and AC Outlet Fuse

The auxiliary power fuse and the AC outlet fuse protect auxiliary power circuits and AC outlet circuits respectively to ensure the UPS's normal operation. Before turning on the UPS, please make sure you have closed the auxiliary power fuse holder. Please see the figures below to open/ close a fuse holder.

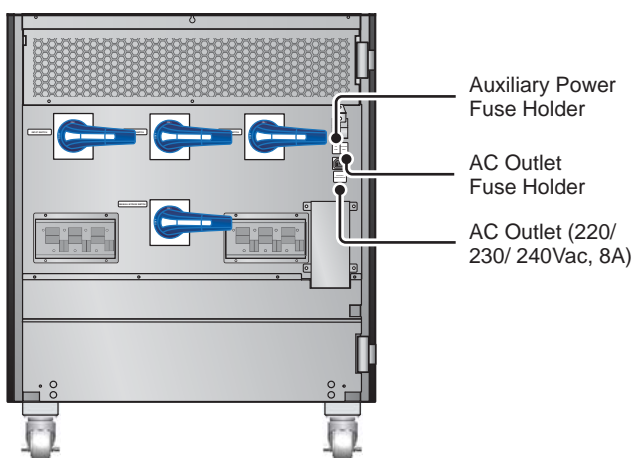

(Figure 2-10: Fuse Holder Location)



NOTE:

1. Only qualified service personnel can use the AC outlet. Before using the AC outlet, please close the AC outlet fuse holder.
2. The AC outlet (220/ 230/ 240Vac, 8A) is not a galvanic isolated output.

Please see the following figure to open/ close a fuse holder.

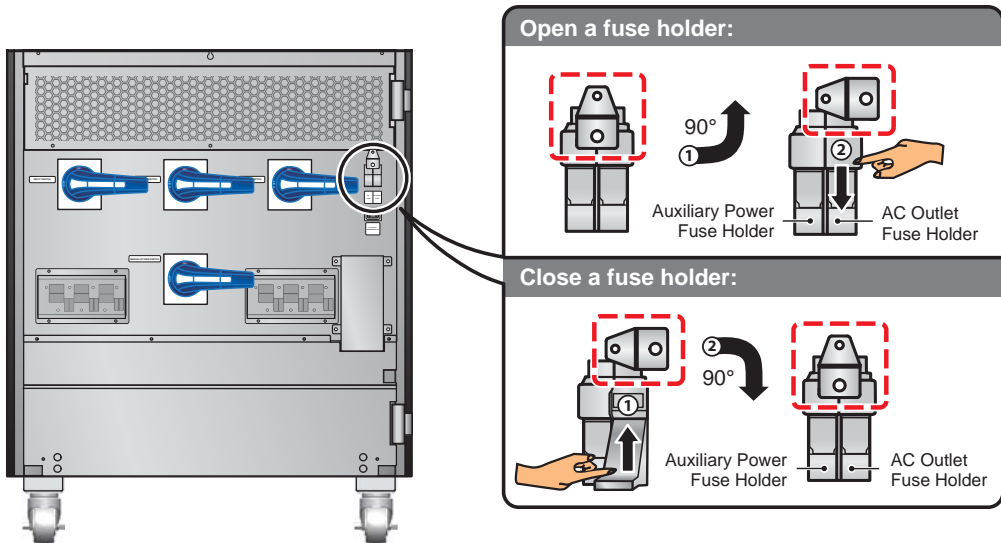

(Figure 2-11: Open/ Close a Fuse Holder)

2.6.3 Wiring Terminal Block

Remove the two panels (❶ and ❷) shown in **Figure 2-12**. For panel ❶, there are four M4 nuts; for panel ❷, there are five M4 screws and one M4 nut. After removing the two panels, you can see the wiring terminal block shown in **Figure 2-13**.

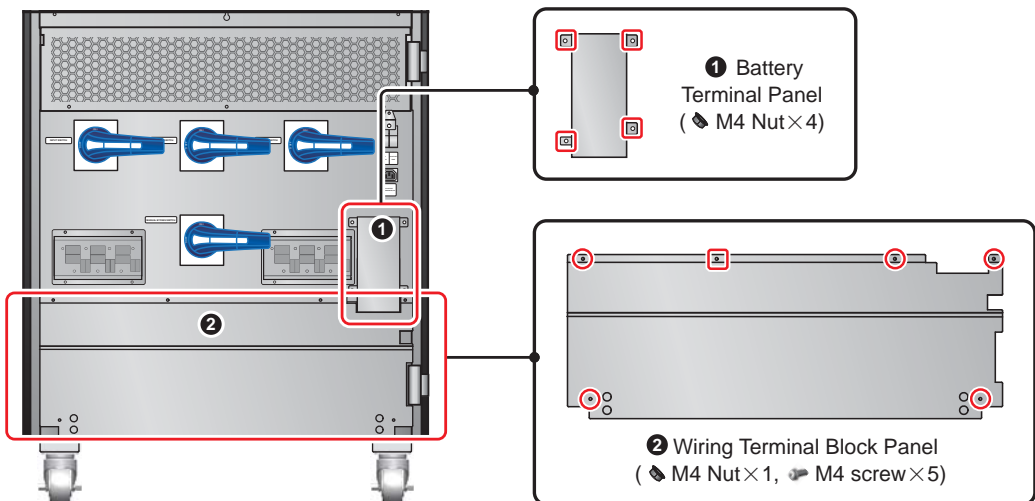

(Figure 2-12: Panel Location)

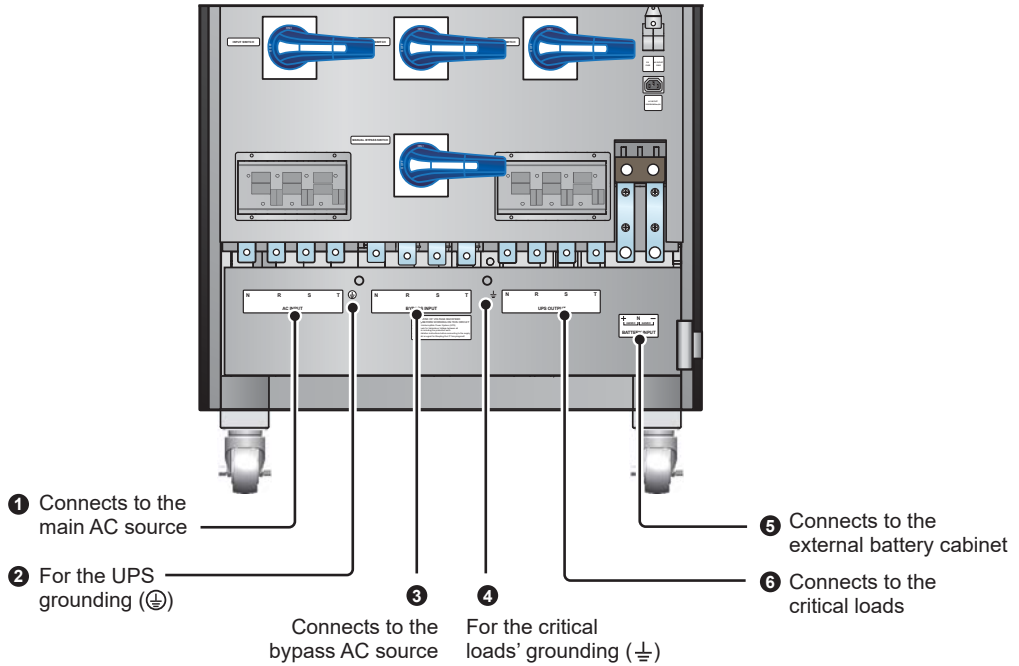

(Figure 2-13: Wiring Terminal Block)

| No. | Item | Function | Description |
|-----|---------------------|--------------------------------------|--|
| 1 | AC Input Block | Connects the main AC source | Includes three phases (R, S, T) and one neutral (N) terminals. |
| 2 | ⊕ | For the UPS grounding (safety) | Includes one grounding terminal. |
| 3 | Bypass Input Block | Connects the bypass AC source | Includes three phases (R, S, T) and one neutral (N) terminals. |
| 4 | ⊕ | For the critical loads' grounding | Includes one grounding terminal. |
| 5 | Battery Input Block | Connects an external battery cabinet | Includes positive (+), negative (-) and neutral (N) terminals. |
| 6 | UPS Output Block | Connects the critical loads | Includes three phases (R, S, T) and one neutral (N) terminals. |

**NOTE:**

1. Only authorized Delta engineers or service personnel can remove the panel of the wiring terminal block and perform wiring. If you want to remove the panel and perform wiring by yourself, you must do it under the supervision of authorized Delta engineers or service personnel.
2. Phase symbols may be different for each country. Please refer to the table below.

| USA/ Asia | Europe | India |
|-----------|--------|-------|
| R | U | R |
| S | V | Y |
| T | W | B |

2.6.4 Communication Interfaces

Communication interfaces include two smart slots, an RS-232 port, a USB port, dry contacts, parallel ports, a parallel switch, and output dry contacts as shown in the figure below. Please see **4. Communication Interfaces for details.**

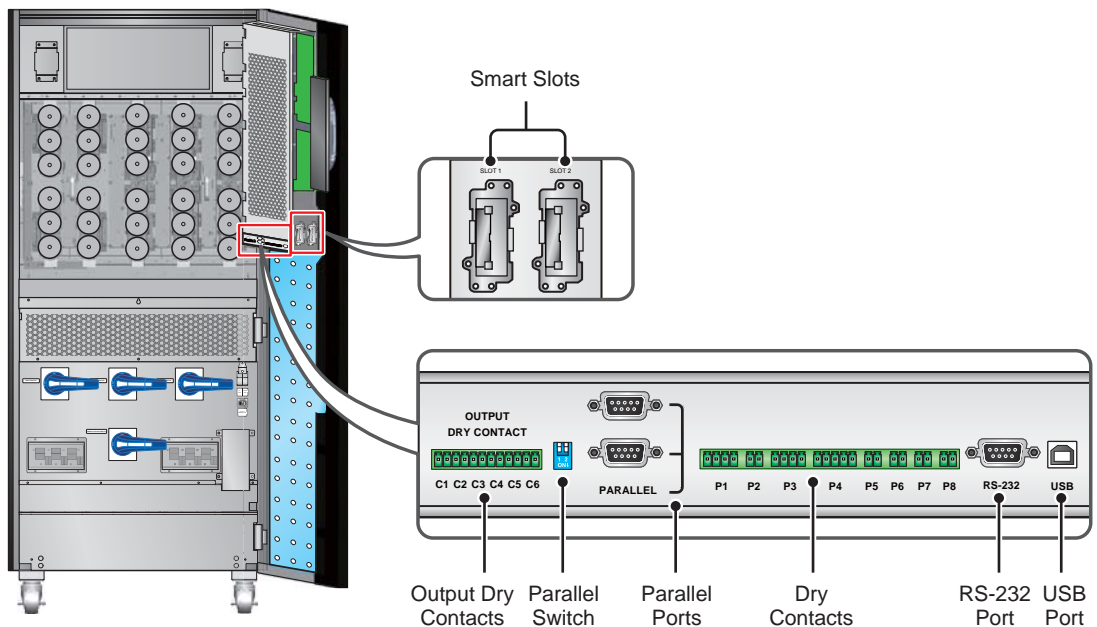

(Figure 2-14: Communication Interfaces)

2.7 Fans

There are fans on the top of the UPS to assist ventilation. Please see **Figure 2-15** for fans location. The system senses the critical loads connected and decides the fan speed. Fans will run at the highest speed only when an over-current condition occurs (battery over temperature is excluded).

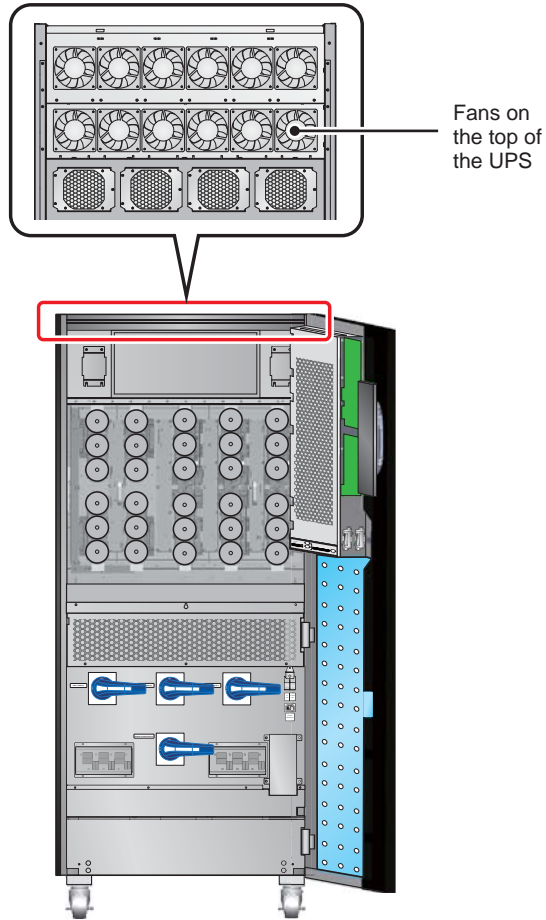

(Figure 2-15: UPS Fan Location)

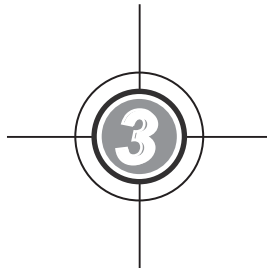

Operation Modes

- 3.1 Normal Mode (Single)
- 3.2 Battery Mode (Single)
- 3.3 Bypass Mode (Single)
- 3.4 Manual Bypass Mode (Single)
- 3.5 ECO Mode
- 3.6 Normal Mode (Parallel)
- 3.7 Battery Mode (Parallel)
- 3.8 Bypass Mode (Parallel)
- 3.9 Manual Bypass Mode (Parallel)
- 3.10 Common Battery

The UPS system supplies power to the connected critical loads with four basic operation modes, which are normal mode, battery mode, bypass mode and manual bypass mode. The unit automatically switches between these modes as required to make sure that the critical loads are protected from power interruption. Besides these four operation modes, the UPS is also designed for common battery and ECO mode functions. Please see the following sections for single unit and parallel units' operation modes, common battery and ECO mode configurations.



NOTE:

Q1, Q2, Q3 and Q4 Switches shown in the following diagrams represent Input Switch, Bypass Switch, Manual Bypass Switch, and Output Switch respectively.

3.1 Normal Mode (Single)

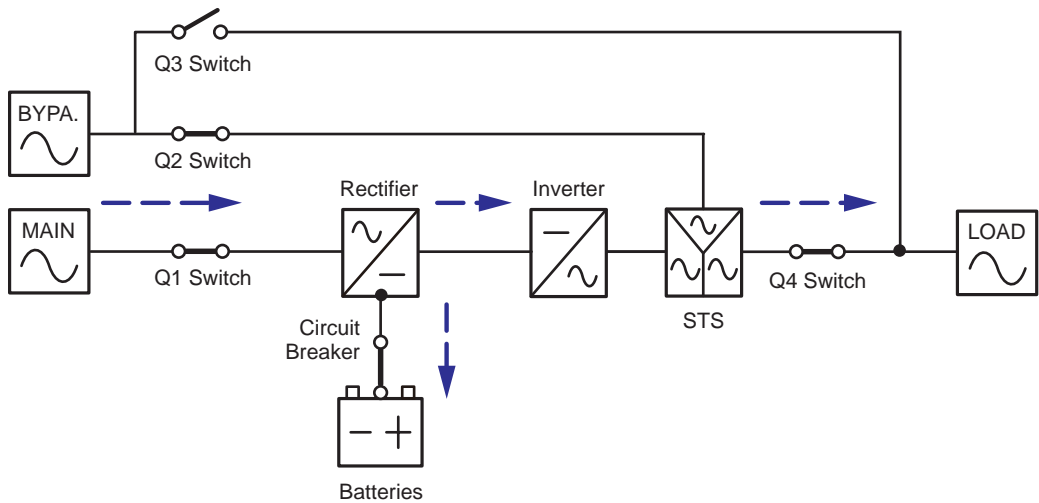

(Figure 3-1: Path of Electrical Power through the UPS in Normal Mode)

In normal mode, the main AC source supplies AC power via the Input Switch (Q1) to the rectifier, and the rectifier converts the AC power to DC power and supplies the DC power to the inverter. In the meantime, the rectifier provides charging power to the batteries. After receiving the DC power, the inverter converts it into clean and stable AC power before the static switch. After that, the inverter supplies the AC power via the static switch and the Output Switch (Q4) to the connected critical loads. During normal mode, LEDs illuminate as follows.

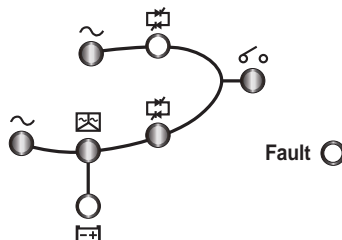

3.2 Battery Mode (Single)

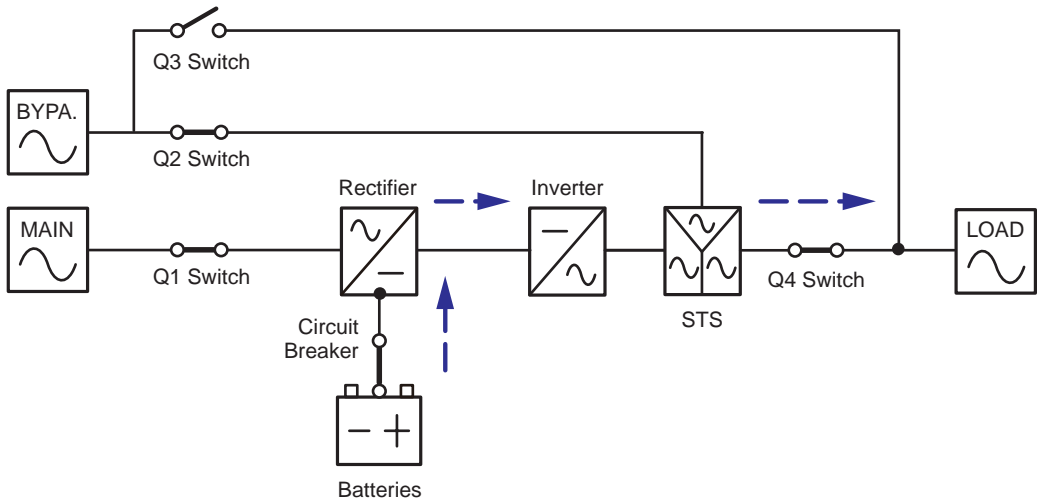

(Figure 3-2: Path of Electrical Power through the UPS in Battery Mode)

The UPS transfers to battery mode automatically if the main AC source cannot supply power, for example, when unstable voltage or a power outage occurs. In battery mode, the batteries provide DC power and the inverter converts it into AC power and supplies it to the connected critical loads via the static switch and the Output Switch (Q4). During the conversion process, output voltage remains the same, and during battery mode, LEDs illuminate as follows.

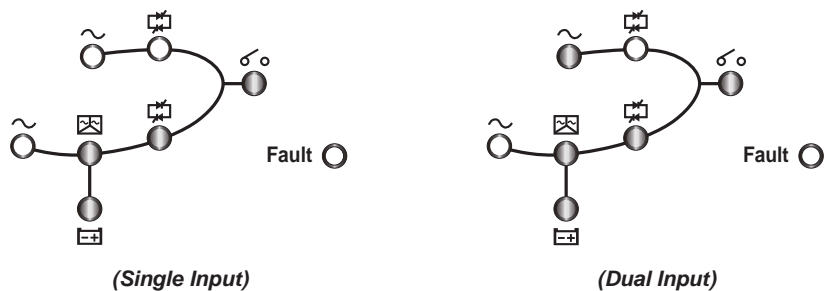

NOTE: The default setting is single input. Please refer to **5.4.2 Single Input/ Dual Input Modification**.

3.3 Bypass Mode (Single)

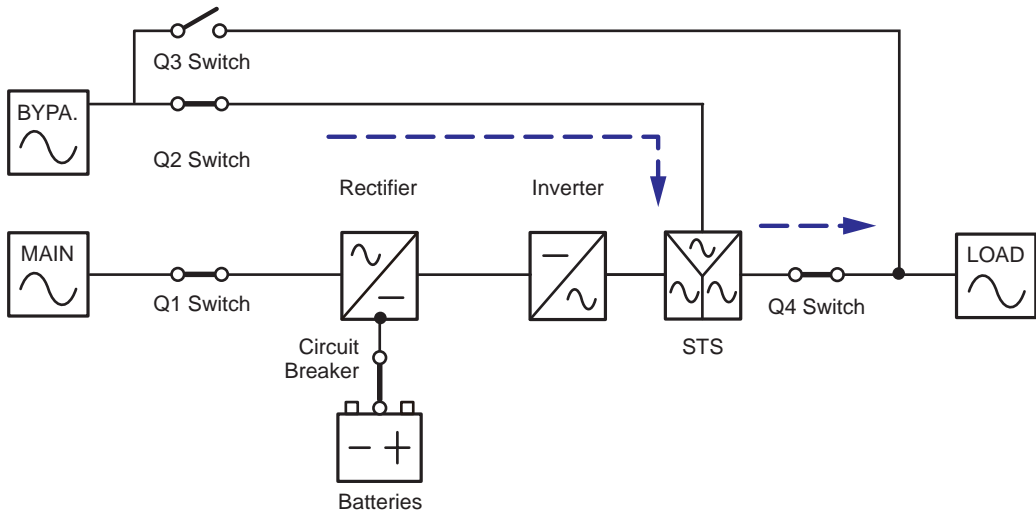

(Figure 3-3: Path of Electrical Power through the UPS in Bypass Mode)

When the inverter encounters abnormal situations such as over temperature, overload, short circuit, abnormal output voltage and battery depletion, it will automatically shut itself down to protect the UPS system. Meanwhile, if the UPS detects the bypass AC source is normal, it will automatically switch to bypass mode to protect the connected critical loads from power interruption. After the abnormalities mentioned above are eliminated, the UPS will switch back to normal mode from bypass mode. During bypass mode, LEDs illuminate as follows.

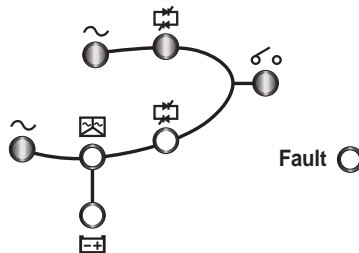

3.4 Manual Bypass Mode (Single)

When the UPS needs maintenance, you can manually switch the UPS to manual bypass mode after you have confirmed the bypass AC source is normal. In manual bypass mode, all power inside the UPS is completely cut off and maintenance personnel can perform maintenance safely. During manual bypass mode, no LED illuminates.

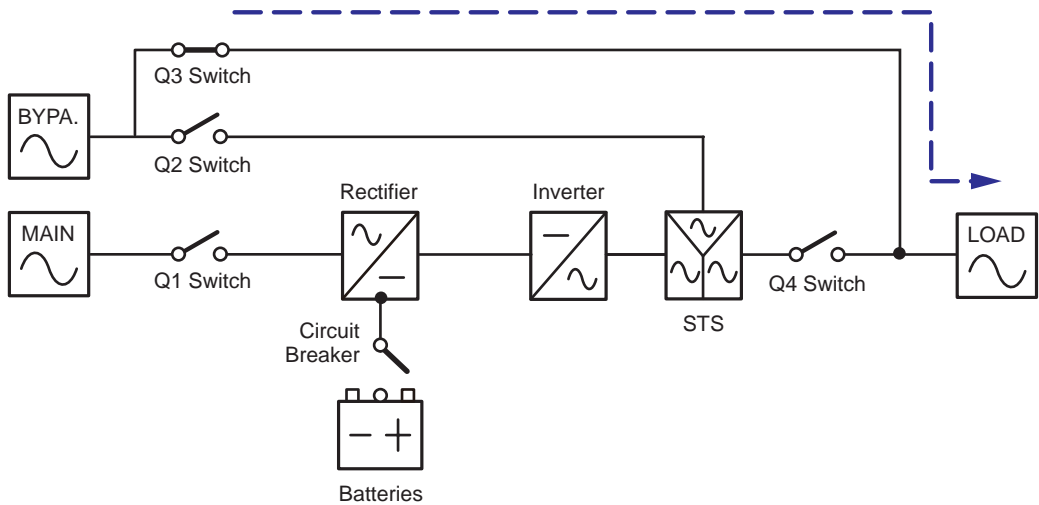

(Figure 3-4: Path of Electrical Power through the UPS in Manual Bypass Mode)



NOTE:

After the power inside the UPS has been completely cut off, there is no high voltage inside the UPS except the wiring terminals and the Manual Bypass Switch (Q3). Do not touch the wiring terminals or the Manual Bypass Switch (Q3) to avoid electrical shock(Q3).

3.5 ECO Mode

You can only use ECO mode for a single unit but not for parallel units. Please refer to **7.4 Main Screen** and **7.7.2 Output Setup**.

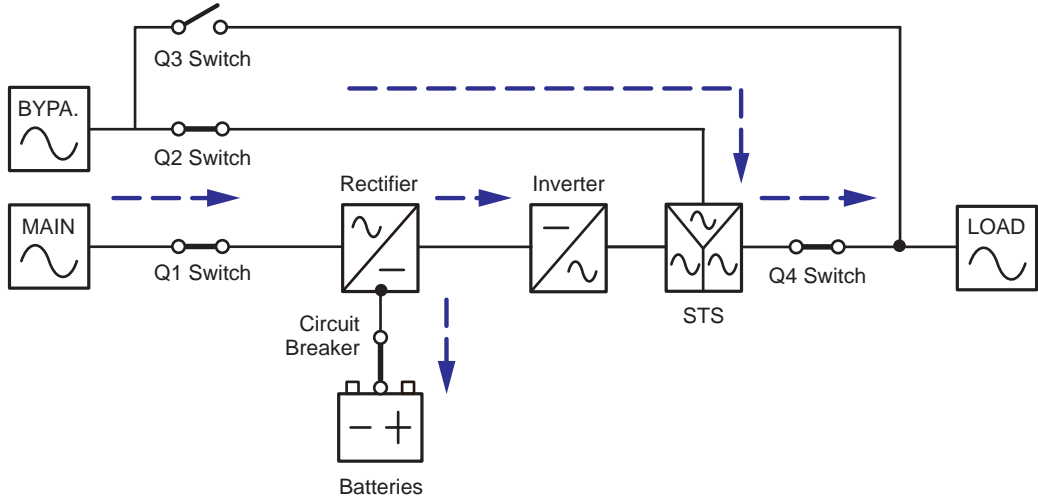

(Figure 3-5: Path of Electrical Power through the Single UPS in ECO Mode)

In ECO mode, when bypass AC source's input voltage and frequency are within the range of rating voltage $\pm 10\%$ and rating frequency $\pm 5\text{Hz}$, the UPS works in bypass mode and LEDs illuminate as follows.

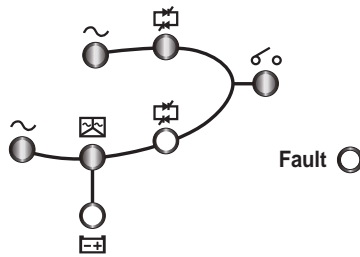

Otherwise, the UPS will work in normal mode. Under these circumstances, LEDs illuminate as follows.

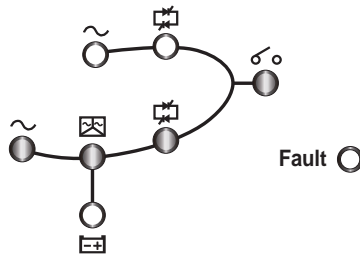

3.6 Normal Mode (Parallel)

The UPS can be paralleled (at maximum eight) to increase capability and redundancy. UPSs with the same capacity, voltage and frequency can be paralleled.

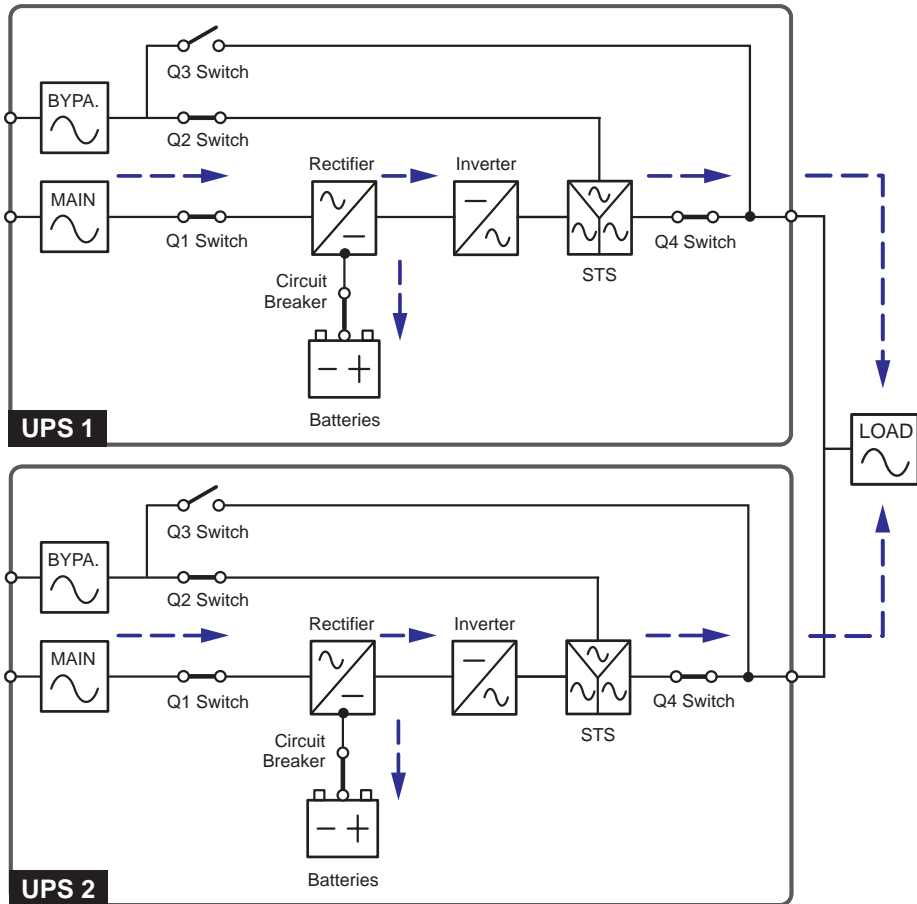

(Figure 3-6: Path of Electrical Power through the Parallel UPSs in Normal Mode)

In normal mode (parallel), the total load will be equally shared by parallel UPSs. If one of the parallel units fails and its load is less than the total capacity of the remaining parallel units, the failing UPS output will be switched off and its load will be equally shared by the other units. If the failing UPS load is larger than the total capacity of the remaining parallel units, all UPSs' inverters will turn off and the total load will be supplied by bypass power. During normal mode, all parallel UPSs' LEDs illuminate as follows.

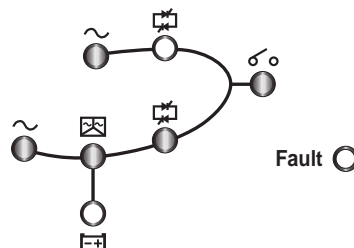

3.7 Battery Mode (Parallel)

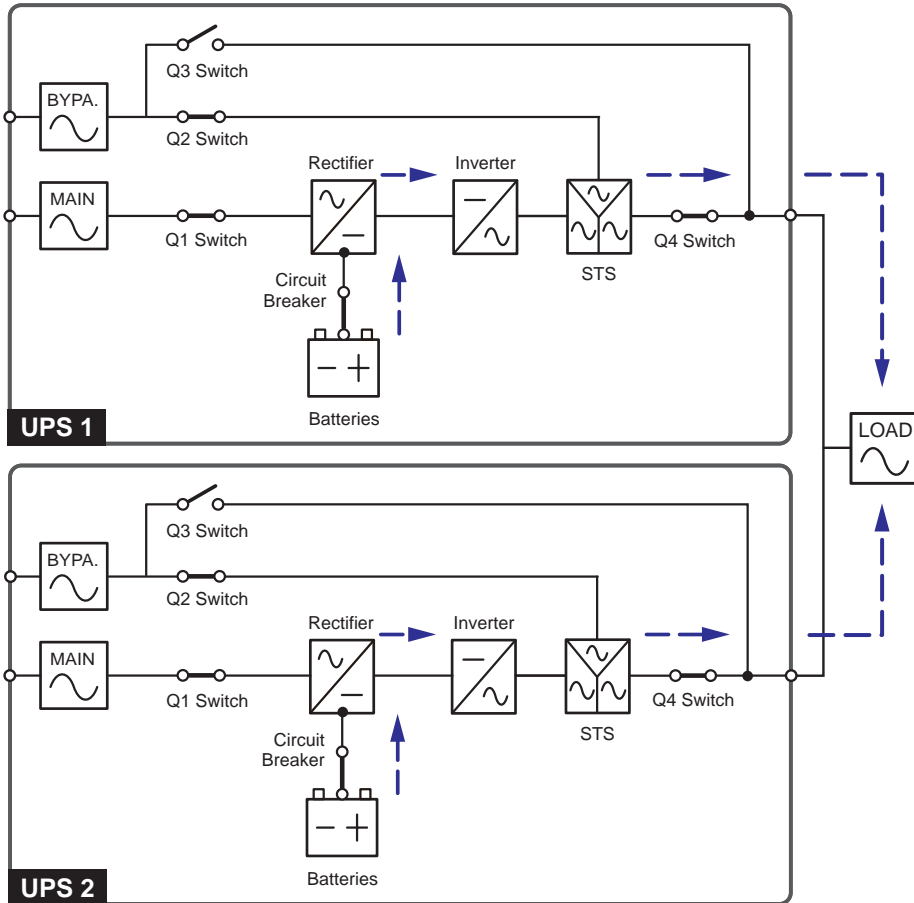

(Figure 3-7: Path of Electrical Power through the Parallel UPSs in Battery Mode)

If the main AC source cannot supply power, for example, when unstable voltage or a power outage occurs, all parallel UPSs will automatically transfer from normal mode to battery mode. During the transfer process, output voltage remains the same, and during battery mode, all parallel UPSs' LEDs illuminate as follows.

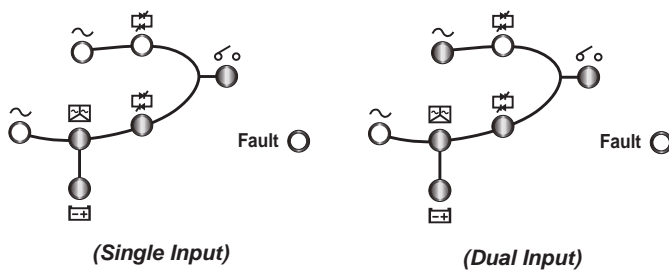

NOTE:

The default setting is single input. Please refer to **5.4.2 Single Input/ Dual Input Modification.**

3.8 Bypass Mode (Parallel)

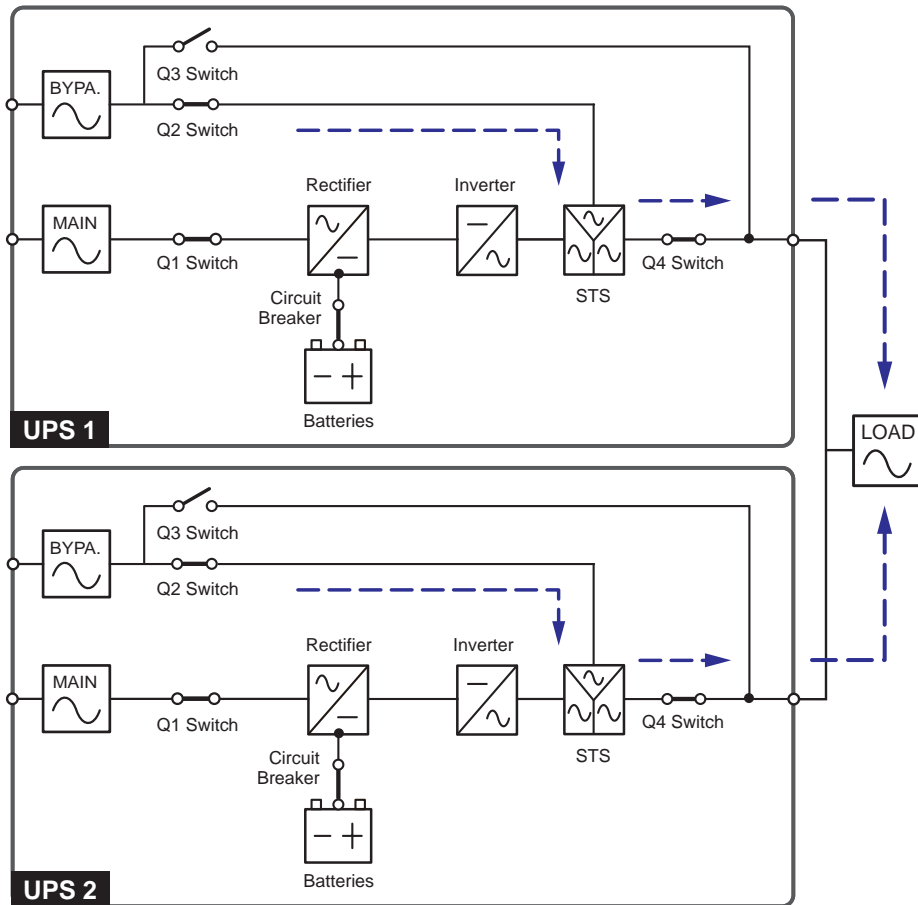

(Figure 3-8: Path of Electrical Power through the Parallel UPSs in Bypass Mode)

In parallel mode, when all inverters encounter abnormal situations such as over temperature, overload, short circuit, abnormal output voltage and battery depletion, they will automatically shut themselves down to protect the UPSs' systems. Meanwhile, if all UPSs detect the bypass AC source is normal, they will automatically switch to bypass mode to protect the connected critical loads from power interruption. The critical loads will be equally shared by all parallel units. After the abnormalities mentioned above are eliminated, the UPSs will switch back to normal mode from bypass mode. During bypass mode, all parallel UPSs' LEDs illuminate as follows.

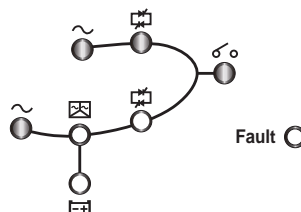

3.9 Manual Bypass Mode (Parallel)

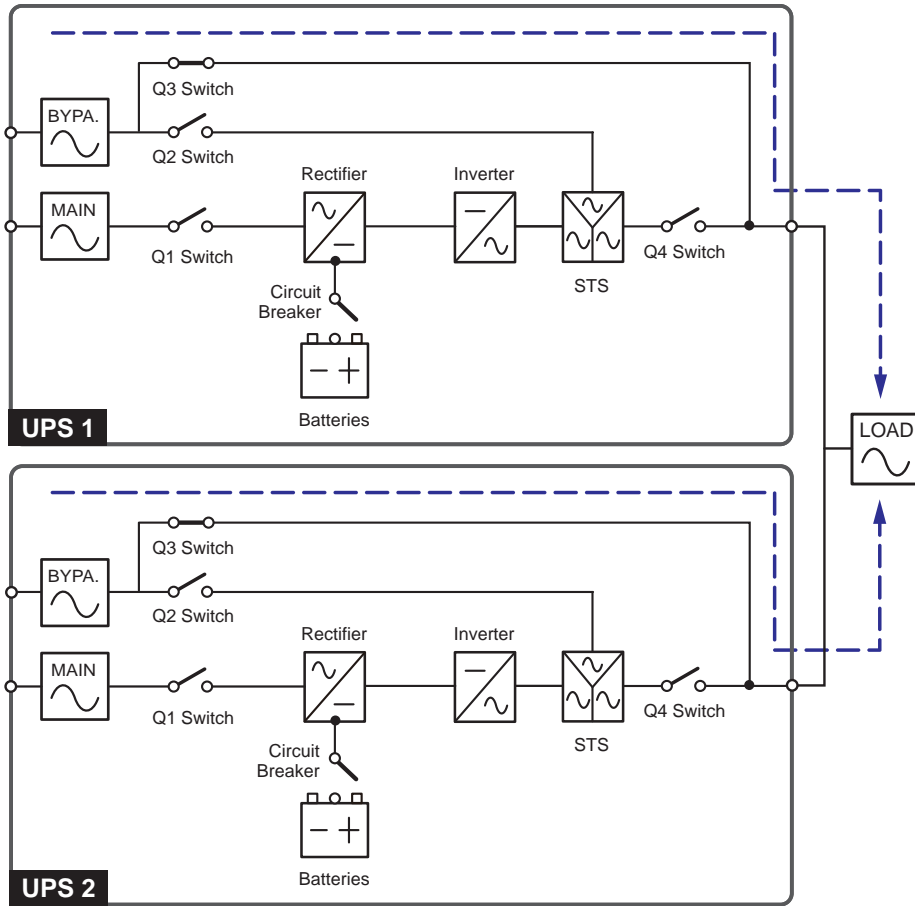

(Figure 3-9: Path of Electrical Power through the Parallel UPSs in Manual Bypass Mode)

In parallel mode, if you want a UPS to run in manual bypass mode, please confirm that the bypass AC source is normal. After confirmation, you can manually switch all UPSs to manual bypass mode. In manual bypass mode, all power inside the UPSs is completely cut off and maintenance personnel can perform maintenance safely. The connected critical loads will be equally supplied by the parallel units see **Figure 3-9**. During manual bypass mode, no LED illuminates.



NOTE:

1. After the power inside all parallel UPSs has been completely cut off, there is no high voltage inside the UPSs except the wiring terminals and the Manual Bypass Switch (Q3). Do not touch the wiring terminals or Manual Bypass Switch (Q3) to avoid electrical shock.
2. For parallel UPSs, if you want to turn off one of the parallel UPSs for maintenance, please make sure the connected critical loads will not exceed the remaining parallel units' total capacity.

3.10 Common Battery

To save on your costs and installation space, parallel UPSs can share external battery cabinets. In common battery mode, please install an isolated switch between each UPS and its connected battery cabinets. Please see **Figure 3-10** for two parallel UPSs sharing one external battery cabinet.

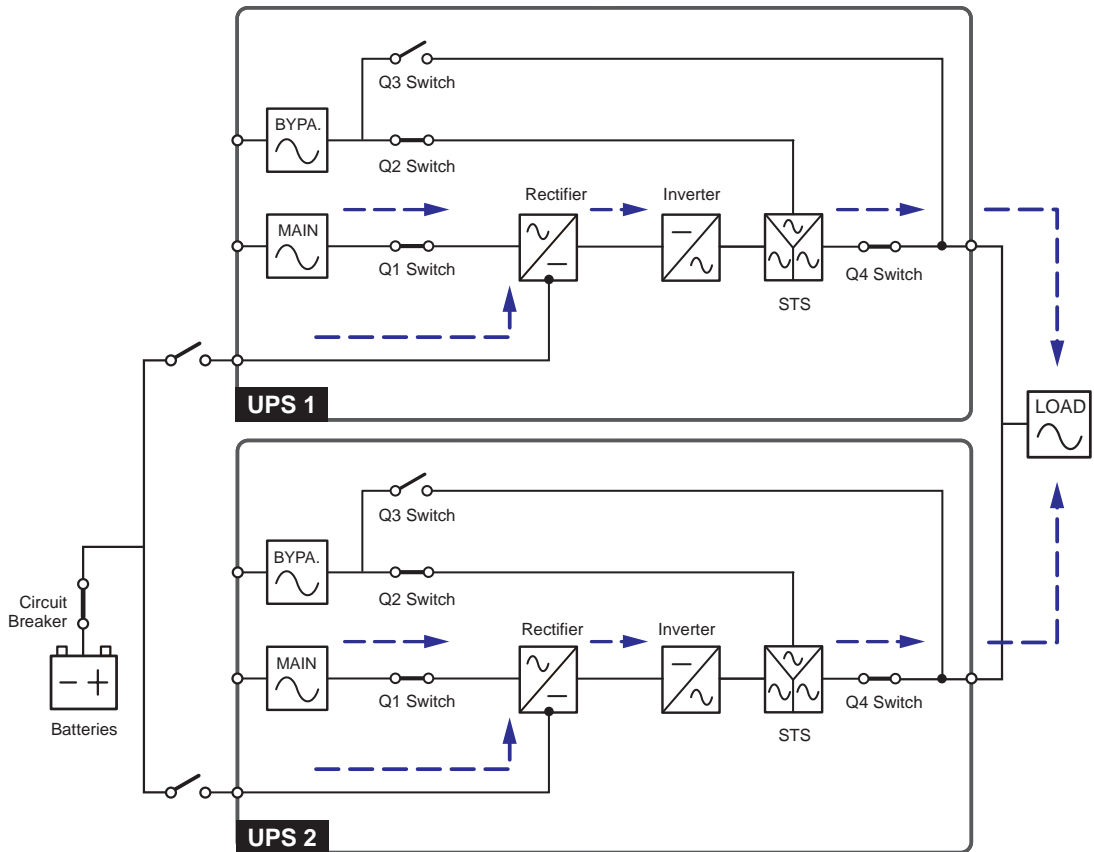

(Figure 3-10: Path of Electrical Power through the Parallel UPSs in Common Battery Mode)

If parallel UPSs share external battery cabinets, you should use the control panel to set up 'TYPE(AH)', 'BAT STRINGS', 'FLOAT CHARGE VOLT(V)', 'BOOST CHARGE VOLT(V)', and 'CHARGE CURRENT(A)'. Please refer to **7.7.3 Battery Setup** and **7.7.4 Charger Setup**.



NOTE:

Please note that you should set each UPS float voltage (default: 272V) the same, each UPS boost voltage (default: 288V) the same, and set each UPS charge current even. For example, when two UPSs are paralleled, they share one battery cabinet, battery type is 120AH, and you want to set the battery cabinet's charge current as 20A. You should set each UPS 'TYPE(AH)' as 60AH, 'BAT STRINGS' as 1, and 'CHARGE CURRENT(A)' as 10A.

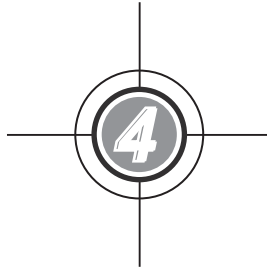

Communication Interfaces

- 4.1 Smart Slots
- 4.2 RS-232 Port & USB Port
- 4.3 Dry Contacts
- 4.4 Parallel Ports
- 4.5 Parallel Switch
- 4.6 Output Dry Contacts

Communication interfaces include two smart slots, an RS-232 port, a USB port, dry contacts, parallel ports, a parallel switch, and output dry contacts as shown in the figure below.

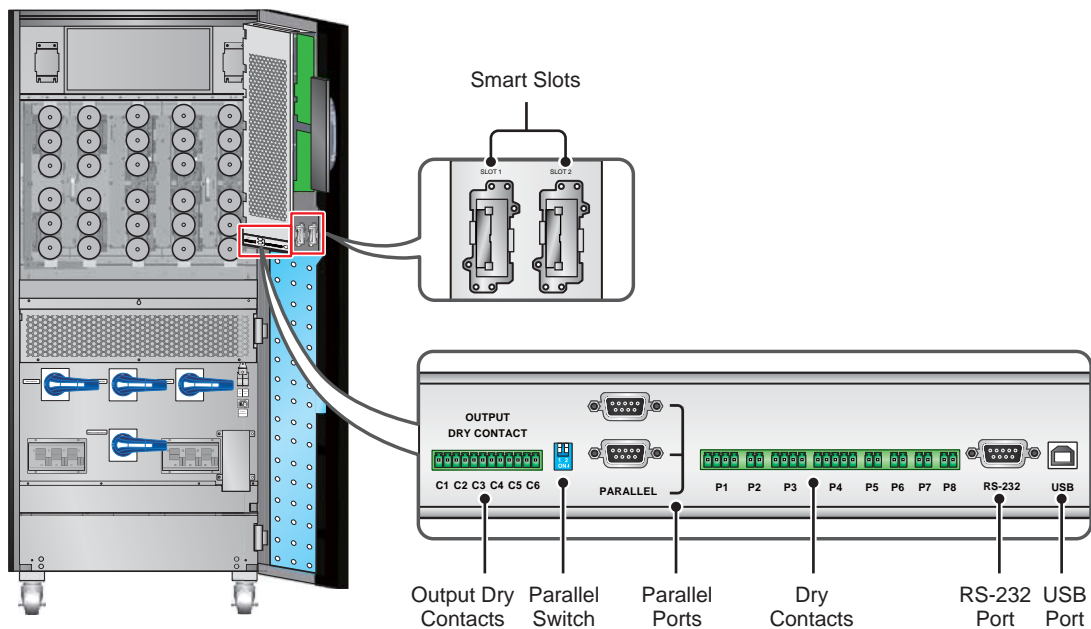

(Figure 4-1: Communication Interfaces)

4.1 Smart Slots

The UPS provides two smart slots. You can choose optional cards to monitor the UPS or to enhance the UPS function. You can use the two slots at the same time and it won't influence the function of the RS-232 port. The list of optional cards is shown in the table below.

| Optional Card | Function |
|--------------------------|--|
| SNMP Card (IPv4 or IPv6) | Helps you remotely monitor the status of the UPS via internet. |
| Relay I/O Card | Increases the quantity of dry contacts. |
| MODBUS Card | Lets the UPS have MODBUS communication. |



NOTE: If you need any optional card, please contact your local dealer or customer service.

4.2 RS-232 Port & USB Port

You can use the provided RS-232 cable or the USB cable to connect the UPS with a computer and use the included CD to install the UPSentry 2012 software (<http://www.deltapowersolutions.com/en/mcis/software-center.php>) to record UPS power events, set up alarms, and shut down the UPS safely. If you wish to monitor several UPSs placed in a computer room or a factory to facilitate centralized control, please contact your local dealer.



NOTE: Do not use the RS-232 port and the USB port at the same time.

4.3 Dry Contacts

The UPS provides eight sets of dry contacts to receive external information of devices connected to the dry contacts. The function of each dry contact is described as follows.

P1: Input dry contacts (two sets)

P2: REPO

P3: External breaker status detection

P4: External battery cabinet status detection

P5: External battery cabinet temperature detection 1

P6: External battery cabinet temperature detection 2

P7: External battery cabinet temperature detection 3

P8: External battery cabinet temperature detection 4

- **P1: Input Dry Contacts (Two Sets)**

In normal conditions, the dry contacts are normally open. If you need to modify the default settings, please contact your local dealer.

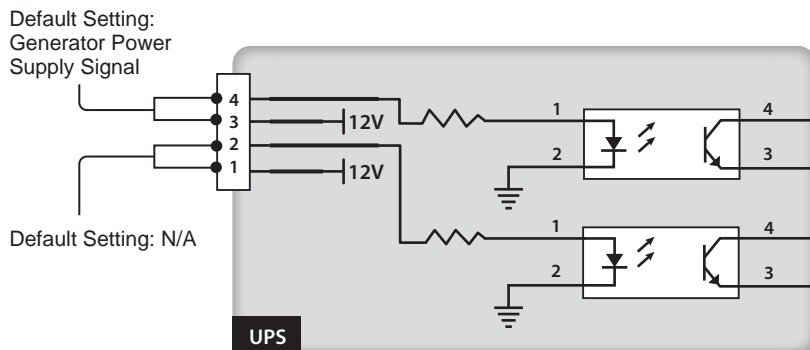

(Figure 4-2: Input Dry Contacts (Two Sets))

- **P2: REPO**

This dry contact provides you with a quick and convenient interface to safely shut down the UPS when an emergency occurs. Connect this dry contact to a user-supplied switch and you can remotely shut down the UPS. The REPO dry contact is normally open in normal circumstances.

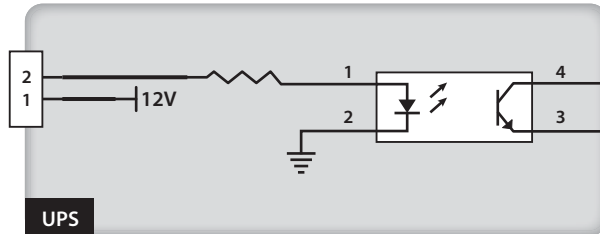

(Figure 4-3: Dry Contacts for REPO)

- **P3: External Breaker Status Detection**

The P3 dry contacts detect the status of the external manual bypass breaker and external input breaker. In normal circumstances, the P3 dry contacts are normally open.

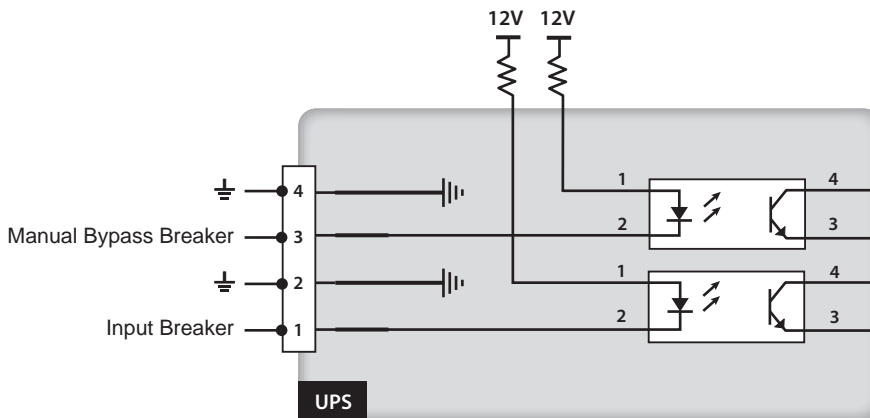

(Figure 4-4: Dry Contacts for External Breakers)

- **P4: External Battery Cabinet Status Detection**

You can use an appropriate cable to connect the UPS's P4 dry contacts and one external battery cabinet to obtain the external battery cabinet's status. Please contact service personnel for cable information.

- **P5~P8: External Battery Cabinet Temperature Detection**

You can purchase a battery cabinet temperature sensor cable (optional) to connect the UPS's dry contacts (P5, P6, P7 or P8) and one external battery cabinet to detect the battery cabinet's temperature. You can use at maximum four temperature sensor cables to connect the UPS and four external battery cabinets.



NOTE: To purchase optional accessories, contact your service personnel. To learn more about all available accessories, please refer to **8. Optional Accessories**.

4.4 Parallel Ports

The two parallel ports are for UPS parallel communication. UPSs (at maximum eight) with the same capacity, voltage and frequency can be coupled via the provided parallel cable to run in parallel mode to increase capability and redundancy.



WARNING:

1. The provided parallel cable is placed in the accessory package. Using other types of cables to connect the UPSs may cause malfunctions.
2. The provided parallel cable's pin design is one-to-one, not crossed.



4.5 Parallel Switch

When you parallel UPSs, you need to set up the parallel switch to activate parallel function. Please see **6.2 Parallel Units Operation Procedures** for parallel switch settings.

4.6 Output Dry Contacts

The UPS provides six sets of programmable output dry contacts for you to receive UPS events. The output dry contacts are normally open and have no default setting. There are 21 events for you to select, and you can choose six of them to set up the output dry contacts. To learn more how to set up, please contact your local dealer. For the nineteen events, please refer to the table below.

| No. | Event | Description |
|-----|--------------------------------------|---|
| 1 | Load on inverter | The UPS works in normal mode. |
| 2 | Load on bypass | The UPS works in bypass mode. |
| 3 | Battery discharge/ Main input NOK | When the main AC source fails, the batteries supply power to the critical loads. |
| 4 | Low battery | When the UPS runs in battery mode, battery voltage is lower than the setup limit, 220Vdc. |
| 5 | Bypass input NOK | The bypass voltage, frequency or phase sequence is abnormal. |
| 6 | Battery test fail or battery missing | During the battery test, the battery voltage is out of the setup limit. |

| No. | Event | Description |
|-----|--|---|
| 7 | Internal communication failure | Power unit's internal communication is abnormal. |
| 8 | External parallel communication loss | In parallel mode, parallel communication is abnormal. |
| 9 | Output overload warning/ shutdown | The UPS is overloaded or the UPS shuts down to let the bypass supply power to the critical loads. |
| 10 | Power module fault shutdown | The power unit has abnormalities and it shuts down the UPS to let the bypass supply power to the critical loads. |
| 11 | Power module warning | The power unit has abnormalities but the UPS still runs in normal mode. |
| 12 | EPO activated | The EPO button  was pressed to urgently power off the UPS. |
| 13 | Load on manual bypass | The Manual Bypass Switch (Q3) is turned on and the UPS transfers to manual bypass mode. |
| 14 | Battery cabinet over temperature warning/ shutdown | The external battery cabinet's temperature is too high. |
| 15 | Abnormal inverter voltage | The output voltage is too high or too low. |
| 16 | Battery needs replacement | Battery replacement date is due. |
| 17 | Bypass over temperature warning/ shutdown | Bypass static switch temperature is too high. |
| 18 | Bypass static switch fault | The bypass static switch has open/ short issue. |
| 19 | General alarm | When any UPS alarm occurs. |
| 20 | External battery breaker shunt trip | The UPS will send a signal to trip the external battery breaker when the EPO button  is pressed. |
| 21 | Backfeed protection | When the UPS has backfeed voltage. |

• Output Dry Contacts Design

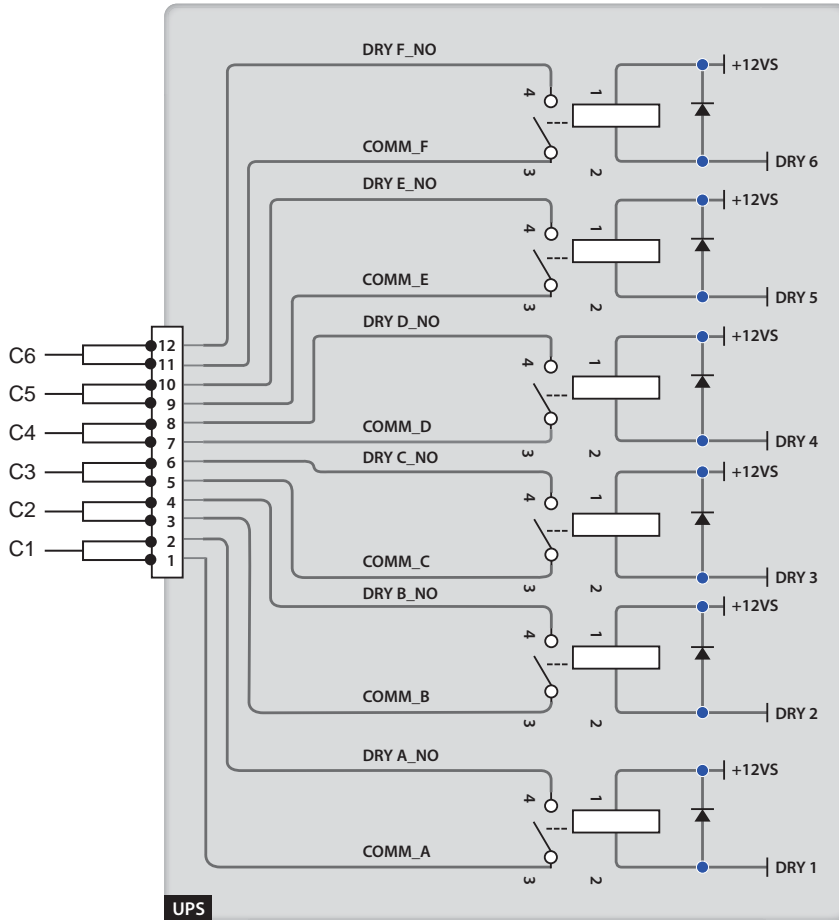

(Figure 4-5: Output Dry Contacts Design)

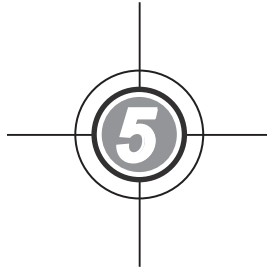

Installation and Wiring

5.1 Before Installation

5.2 Installation Environment

5.3 Transportation

5.4 Fixing the UPS

5.5 Wiring

5.6 External Battery Cabinet
Connection Warnings

5.1 Before Installation

Due to different installation environments, it is highly recommended that you read this user manual before installation. Only authorized Delta engineers or service personnel can perform installation and maintenance. If you want to install the UPS by yourself, installation must be under the supervision of authorized Delta engineers or service personnel. If you use a forklift or other equipment to move the UPS, please make sure its load bearing is sufficient. Please refer to **Table 5-1**.

5.2 Installation Environment

- Install the UPS indoors. Do not place it outdoors.
- Make sure that transportation routes (e.g. corridor, door gate, elevator, etc.) and installation area can accommodate and bear the weight of the UPS, external battery cabinets and forklifts. Please see **Table 5-1** for floor weight loading information.

Table 5-1: DPS UPS Floor Weight Loading Table

| DPS UPS | | |
|-------------------------------------|-----|-----|
| Rating (kVA) | 160 | 200 |
| Weight (Kg) | 583 | 583 |
| Weight Loading (kg/m ²) | 795 | 795 |

- Keep the installation area clean. Please note that wiring routes must be hermetic to prevent possible damage from rodents.
- Ensure that the installation area is big enough for maintenance and ventilation. Since the fans of the UPS ventilate from bottom to top (please see **Figure 5-1**) and external battery cabinets must be placed next to the UPS, we suggest that you:
 1. Keep a distance of 100cm from the front of the UPS for maintenance and ventilation.
 2. Keep a distance of 60cm from the back of the UPS for maintenance and ventilation.
 3. Keep a distance of 100cm from the top of the UPS for maintenance.

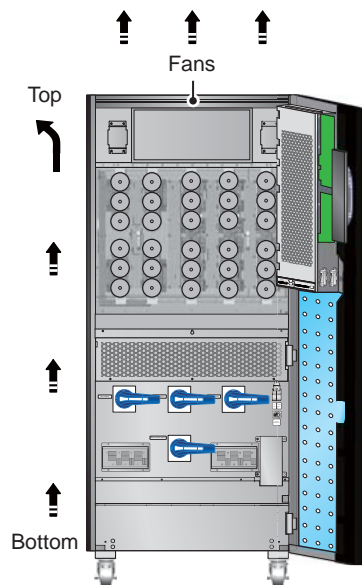

(Figure 5-1: Fan Ventilation Direction)

- Keep the installation area's temperature around 25°C and humidity within 90%. The highest operating altitude is 1000 meters above sea level.
- For safety concerns, we suggest that you:
 1. Equip surroundings of the installation area with CO₂ or dry powder fire extinguishers.
 2. Install the UPS in an environment where fireproof materials are used to construct the walls, floors and ceilings.
- Do not allow unauthorized personnel to enter the installation area. Assign specified personnel to keep the UPS key.

**WARNING:**

Do not use air conditioners or similar equipment to blow into the top of the UPS and hinder ventilation.

5.3 Transportation

- At the bottom of the UPS, there are four casters to help you to move the UPS to a designated area. Before you move the UPS, please turn the four levelers counterclockwise to raise them off the ground. This protects the levelers from damage when moving the UPS. Please use sufficient manpower (at least six people) and equipment (e.g. forklift) to carefully move the UPS from pallet to ground. Please pay attention to the movement of the casters to avoid accidents.

**WARNING:**

The UPS is fixed on the pallet with four balance supports. When taking apart the four balance supports from the UPS, please pay attention to the movement of the casters to avoid accidents. Please refer to the **Unpacking Guide** attached to the UPS external wooden box for location of balance supports.

- The casters are designed to move on level ground. Do not move the UPS on an uneven surface. This might cause damage to the casters or tip the UPS which could damage the unit.
- After the UPS has been removed from the pallet to ground, we suggest that at least three people move the UPS to the installation area. One person use their hands to hold a lateral side of the UPS, one person hold the other lateral side of the UPS with their hands, and one person use their hands to push the UPS either from the front side or from the backside to move the unit to the installation area and avoid tipping the UPS.

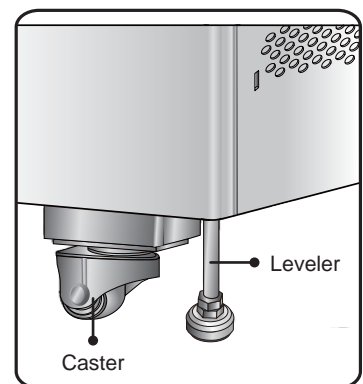

(Figure 5-2: Caster and Leveler)

- If you need to move the UPS over a long distance, please use appropriate equipment like a forklift. Do not use the UPS casters to move the unit over a long distance.

5.4 Fixing the UPS

Please follow the steps below:

- 1 Before fixing the UPS in a designated area, please double check whether the area's floor weight loading is sufficient to bear the UPS and Delta external battery cabinets to avoid accidents. Please refer to **Table 5-1**.
- 2 After moving the UPS to the designated area, please use a 17mm combination wrench to stabilize the four levelers on the floor. Please note that the UPS must stand on the floor firmly and levelly without any tipping.
- 3 To prevent possible damage from rodents, please take the provided four rodent shields (including 12 M4 screws) out of the accessory package and install them on the UPS.
- 4 Use the supplied four M4 screws to fix one long rodent shield with two rodent short shields. Please see **Figure 5-3**.
- 5 Use the supplied two M4 screws to fix the assembled rodent shields (□ shape) on the UPS. Please see **Figure 5-3**.

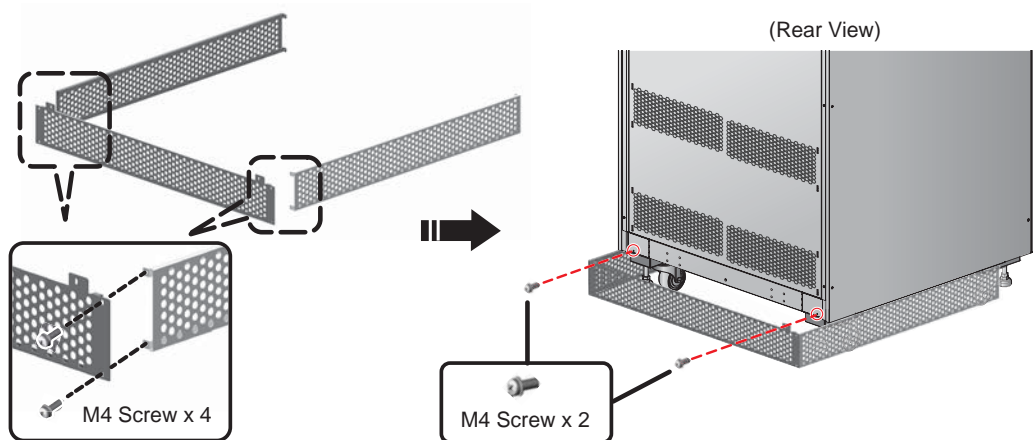

(Figure 5-3: Install the Rodent Shields at the Rear of DPS)

- 6 Use a 10mm bushing tool and eight M6 screws ❶ (originally fixed the UPS's balance supports on the pallet) to install the two balance supports (removed from the UPS during the unpacking process) at the rear of the UPS. Use two expansion screws ❷ to fix the balance supports on the ground to a void UPS movement. Service personnel should provide the expansion screws. Please see **Figure 5-4**.

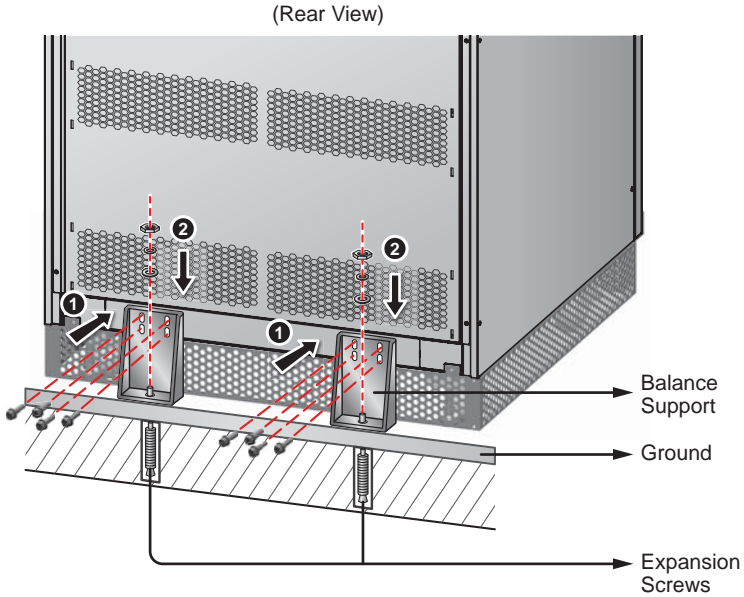

(Figure 5-4: Install the Balance Supports at the Rear of DPS)

- 7 Remove the two panels shown in **Figure 2-12**. Follow **5.5 Wiring** to perform wiring.
- 8 Use a 10mm bushing tool and eight M6 screws ① (originally fixed the UPS's balance supports on the pallet) to install the two balance supports (removed from the UPS during the unpacking process) at the front of the UPS. Use two expansion screws ② to fix the balance supports on the ground to avoid UPS movement. Service personnel should provide the expansion screws. Please see **Figure 5-5**.

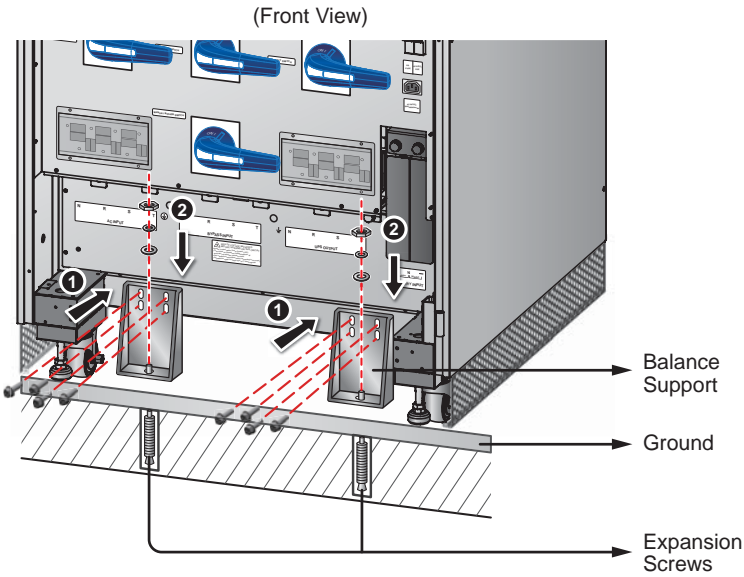

(Figure 5-5: Install the Balance Supports at the Front of DPS)

- 9 After wiring, reinstall the two panels shown in **Figure 2-12**, fix the remaining long rodent shield on the front of the UPS using the provided two M4 screws **1**, and use the remaining four M4 screws **2** to fix the long rodent shield with the two short rodent shields shown. Please see **Figure 5-6**.

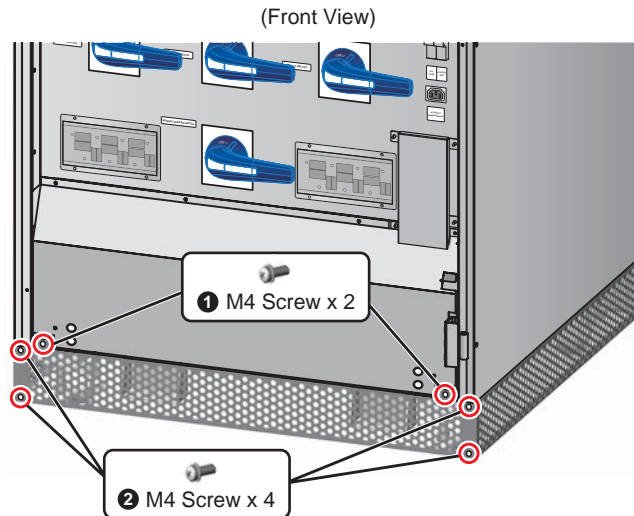

(Figure 5-6: Install the Rodent Shields at the Front of DPS)



WARNING:

If you don't use the balance supports to fix the UPS, the unit might topple over. For safety concerns, please use the balance supports to fix the UPS to the floor.

5.5 Wiring

5.5.1 Pre-wiring Warnings

- Before wiring or making any electrical connection, make sure the power supplied to the input and output of the UPS is completely cut off.
- Check that the size, diameter, phase, and polarity are correct for each cable that needs connecting to the UPS. Please refer to **Table 5-2**.

Table 5-2: Input/ Output Electrical Data

| UPS Rating | 160kVA | 200kVA |
|----------------------|--|---|
| Input Voltage | 220/ 380 Vac or 230/ 400 Vac or 240/ 415 Vac | 220/ 380 Vac or 230/ 400 Vac or 240/ 415 Vac |
| Output Voltage | 220/ 380 Vac or 230/ 400 Vac or 240/ 415 Vac | 220/ 380 Vac or 230/ 400 Vac or 240/ 415 Vac |
| Input Cable | 50mm ² × 2 PCS or 185mm ² × 1 PC | 95mm ² × 2 PCS or 240mm ² × 1 PC |
| Bypass Switch | 400A | 400A |
| Bypass Cable | 50mm ² × 2 PCS or 185mm ² × 1 PC | 95mm ² × 2 PCS or 240mm ² × 1 PC |
| Manual Bypass Switch | 400A | 400A |
| Output Switch | 400A | 400A |
| Output Cable | 50mm ² × 2 PCS or 185mm ² × 1 PC | 95mm ² × 2 PCS or 240mm ² × 1 PC |
| Battery Cable | 70mm ² × 2 PCS or 240mm ² × 1 PC or 000kcmil × 2 PCS or 500kcmil × 1 PC | 95mm ² × 2 PCS or 300mm ² × 1 PC or 0000kcmil × 2 PCS or 600kcmil × 1 PC |
| Battery Fuse | 400A | 500A |
| Grounding Cable | 50mm ² × 2 PCS or 185mm ² × 1 PC | 95mm ² × 2 PCS or 240mm ² × 1 PC |

**NOTE:**

1. Please refer to national and local electrical codes for acceptable non-fuse breakers and cable size.
2. In accordance with **National Electrical Codes (NEC)**, please install a suitable conduit and bushing.
3. Cables with PVC material and with temperature resistance up to 105°C are suggested.
4. The tightening torque for M8 screws should be 150 ±5kgf·cm, and for M10 screws, 250 ±5kgf·cm.

- To avoid UPS failure, the input of the UPS must be a Y connection and the UPS neutral (N) must be connected. Do not connect the UPS neutral (N) with the ground (⊕).
- If there is a floating voltage between the input power's neutral (N) and the ground (⊕), and you require that the VNG of the UPS should be zero, we suggest that you install an isolation transformer in front of the input side of the UPS, and connect the UPS neutral (N) with the ground (⊕).

- **AC Power Source Connection**

Three phases (R/ S/ T) of the AC power source must be in positive phase sequence, and R, S, T and N cables of the AC power source must be connected to the 'R', 'S', 'T' and 'N' interfaces marked on the Main Input Block and the Bypass Input Block accordingly.

- **External Battery Cabinet Connection**

Connect positive and negative poles and the neutral terminal of an external battery cabinet to the '+', '-' and 'N' interfaces marked on the Battery Input Block. Do not make a wrong connection.

- **External Battery Cabinet Grounding**

Connect an external battery cabinet's grounding terminal to the terminal of ground (⊕). Do not connect the grounding terminal of the external battery cabinet to any other grounding system.

- The terminal of ground (⊕) must be grounded. Please use ring-type terminals for wiring.



WARNING:

1. Wrong wiring will cause damage to the UPS and electric shock.
2. The UPS will not work normally if the input power's neutral (N) is not firmly connected or not connected to the Main Input Block's neutral (N) terminal.

5.5.2 Single Input/ Dual Input Modification



WARNING:

Only authorized Delta engineers or service personnel can modify single input/ dual input setup.

The UPS default setting is single input. If you want to modify it into dual input, please follow the following steps.

- 1 Remove the three panels shown in **Figure 5-7**.

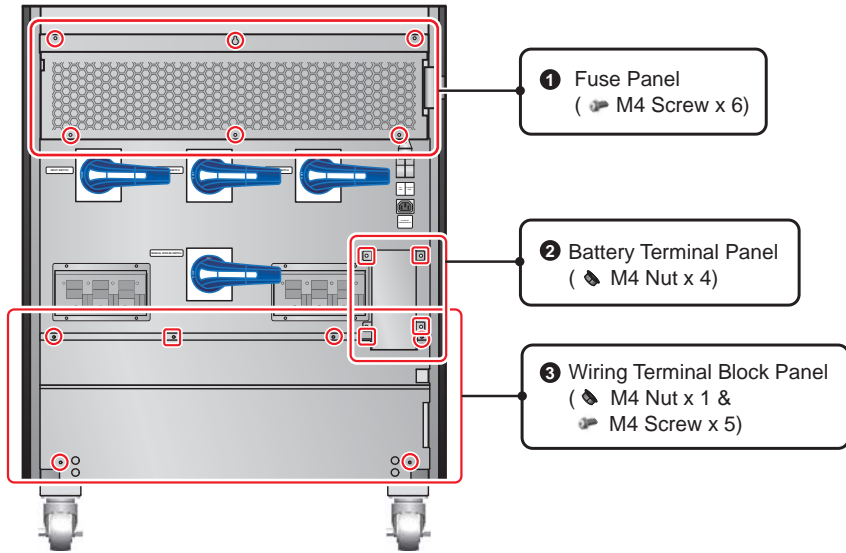

(Figure 5-7: Remove the Three Panels)

- 2 Remove the Input Switch (Q1), Bypass Switch (Q2), Manual Bypass Switch (Q3) and Output Switch (Q4). To remove a switch, please remove its two screw covers 1 and two screws 2 shown in **Figure 5-8**.

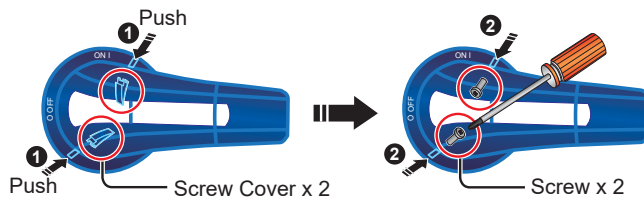

(Figure 5-8: How to Remove a Switch)

- 3 Unscrew the 6 screws shown in **Figure 5-9** to remove the switch panel shown.

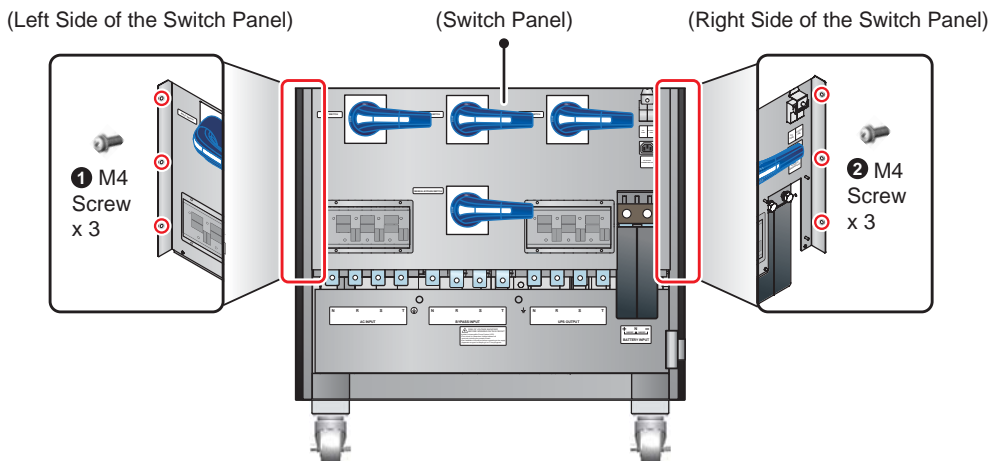

(Figure 5-9: How to Remove the Switch Panel)

- 4 After removing the panels, please use a socket wrench to loosen the six screws shown in **Figure 5-10**, remove the three copper bars and re-install the six screws back to the original location (tightening torque: $250\pm 5\text{kgf}\cdot\text{cm}$) to modify the UPS into dual input.

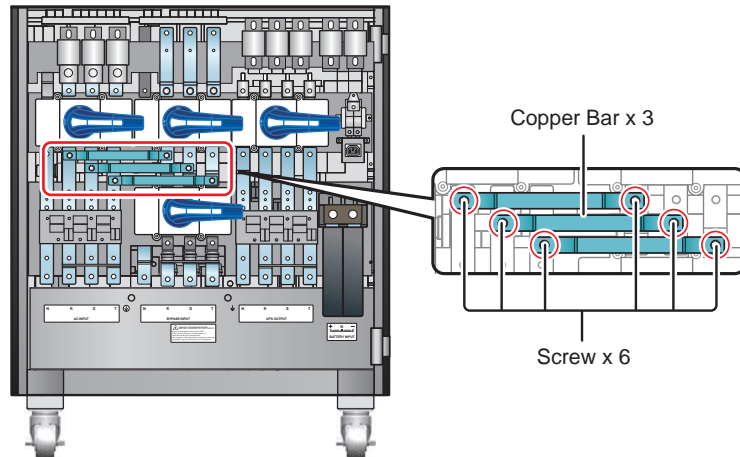

(Figure 5-10: Location of Six Screws and Three Copper Bars)



NOTE: If you want to modify the UPS from dual input into single input, please use the socket wrench to reinstall the three copper bars back.

5.5.3 Single Unit Wiring



NOTE: Before wiring, please read **5.5.1 Pre-wiring Warnings**.

- **Single Input (Single Unit)**

When there is only one AC power source, single unit wiring procedures are as follows.

- 1 Open the front door and follow the steps 1 ~ 3 stated in **5.5.2 Single Input/ Dual Input Modification** to remove the according panels. After that, you will see the wiring terminal block shown in **Figure 5-11**.
- 2 The wiring terminal block includes:

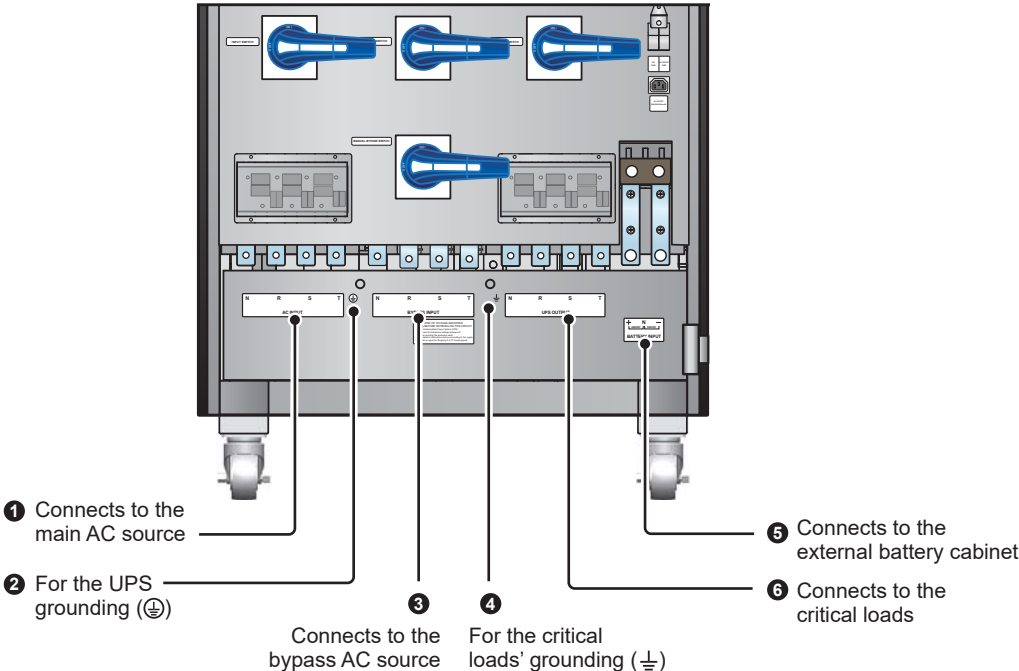

(Figure 5-11: Wiring Terminal Block)

| No. | Item | Description | Function |
|----------|---------------------|----------------------------------|---|
| 1 | AC Input Block | Includes R/ S/ T/ N terminals. | Connects to the main AC source. |
| 2 | ⊕ | Includes one grounding terminal. | For the UPS grounding. |
| 3 | Bypass Input Block | Includes R/ S/ T/ N terminals. | Connects to the bypass AC source. |
| 4 | ⊕ | Includes one grounding terminal. | For the critical loads' grounding. |
| 5 | Battery Input Block | Includes +/ -/ N terminals. | Connects to the external battery cabinet. |
| 6 | UPS Output Block | Includes R/ S/ T/ N terminals. | Connects to the critical loads. |

- 3 The UPS rating voltage is 220/380Vac, 230/400Vac or 240/415Vac.
- 4 The battery rating voltage is $\pm 240\text{Vdc}$.
- 5 Make sure the Input Switch (Q1), Bypass Switch (Q2), Manual Bypass Switch (Q3) and Output Switch (Q4) are in the **OFF** position. Please see **Figure 5-12** for switch location.

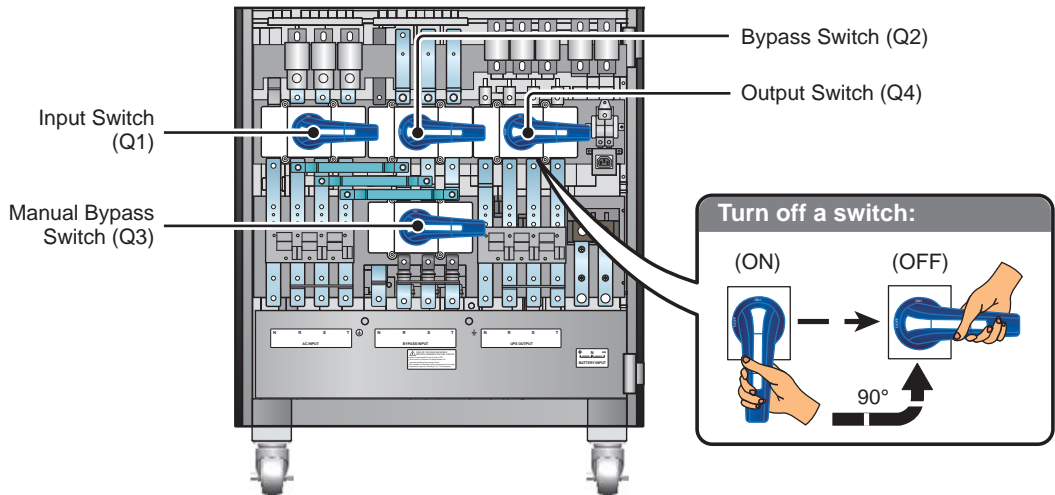

(Figure 5-12: Switch Location and Turn off a Switch)

- 6 Follow UPS model No. to select appropriate input/ output cables. Please refer to **Table 5-2**.
- 7 Connect the main AC source/ UPS output/ external battery cabinet cables to the wiring terminal block. Please refer to **Figure 5-13** and **5.6 External Battery Cabinet Connection Warnings**.
- 8 Ground the UPS.

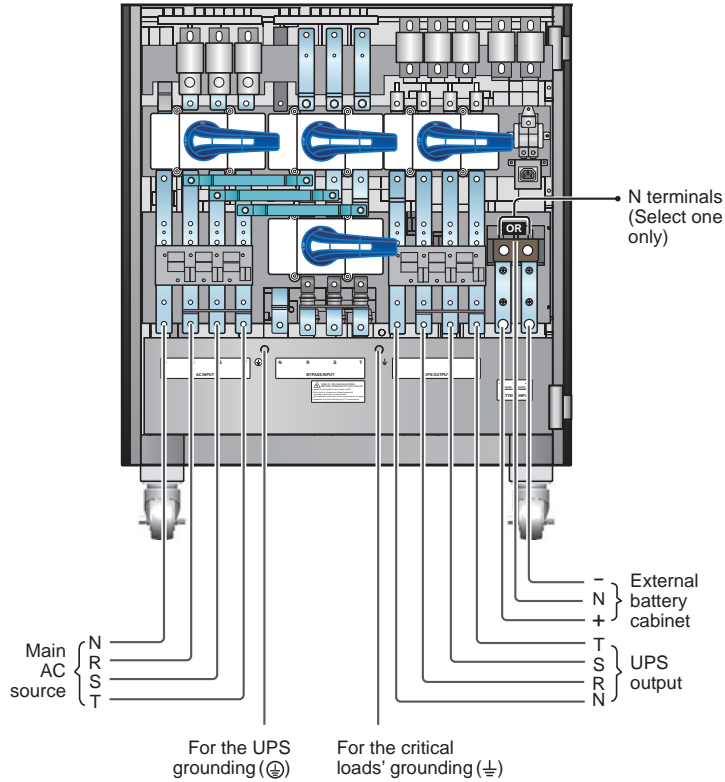

(Figure 5-13: Single Unit Single Input Wiring Diagram)

• Dual Input (Single Unit)

When there are two AC power sources, single unit wiring procedures are as follows.

- 1 Follow **5.5.2 Single Input/ Dual Input Modification** to modify the UPS into dual input.
- 2 Refer to the procedures 1 ~ 6 stated in the section of **Single Input (Single Unit)**.
- 3 Connect the main AC source/ bypass AC source/ UPS output/ external battery cabinet cables to the wiring terminal block. Please refer to **Figure 5-14** and **5.6 External Battery Cabinet Connection Warnings**.
- 4 Ground the UPS.

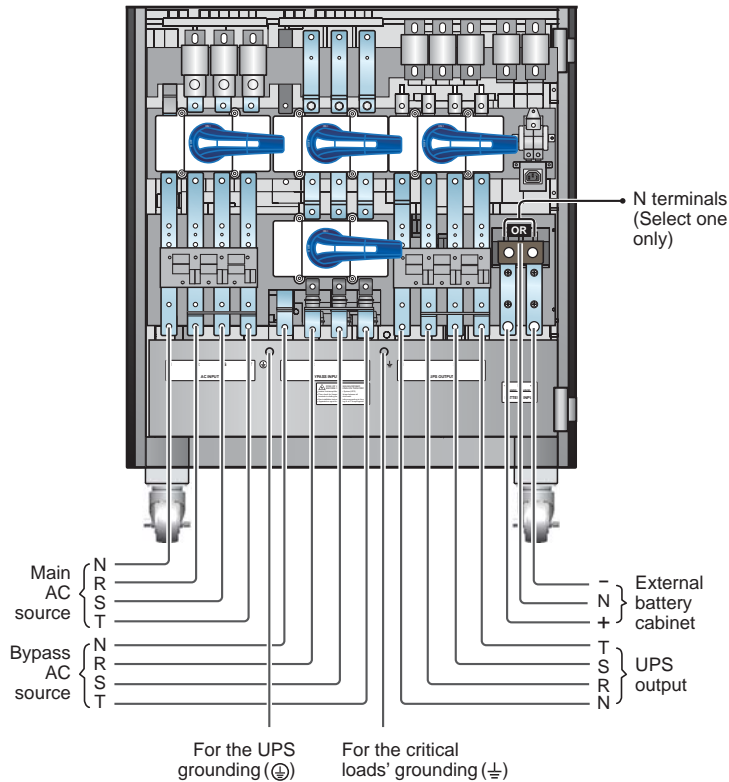

(Figure 5-14: Single Unit Dual Input Wiring Diagram)

5.5.4 Parallel Unit Wiring



NOTE: Before wiring, please read **5.5.1 Pre-wiring Warnings**.

- **Single Input (Parallel Units)**

When there is only one AC power source, parallel units' wiring procedures are as follows.

- 1) Follow the procedures 1) ~ 6) stated in the section of **Single Input (Single Unit)**.
- 2) Connect the main AC source/ UPS output/ external battery cabinet cables to the wiring terminal block. Please refer to **Figure 5-13**, **Figure 5-15** and **5.6 External Battery Cabinet Connection Warnings**.
- 3) Use the provided parallel cable to connect the parallel ports on the parallel units. Please see **Figure 4-1** for parallel port location.
- 4) Ground the parallel UPSs.

**WARNING:**

1. When UPSs are paralleled, the length of each unit's input cables plus output cables must be the same. This ensures that the parallel UPSs can equally share the critical loads in bypass mode.
2. Only UPSs with the same capacity, voltage and frequency can be paralleled; otherwise, parallel functions will fail.

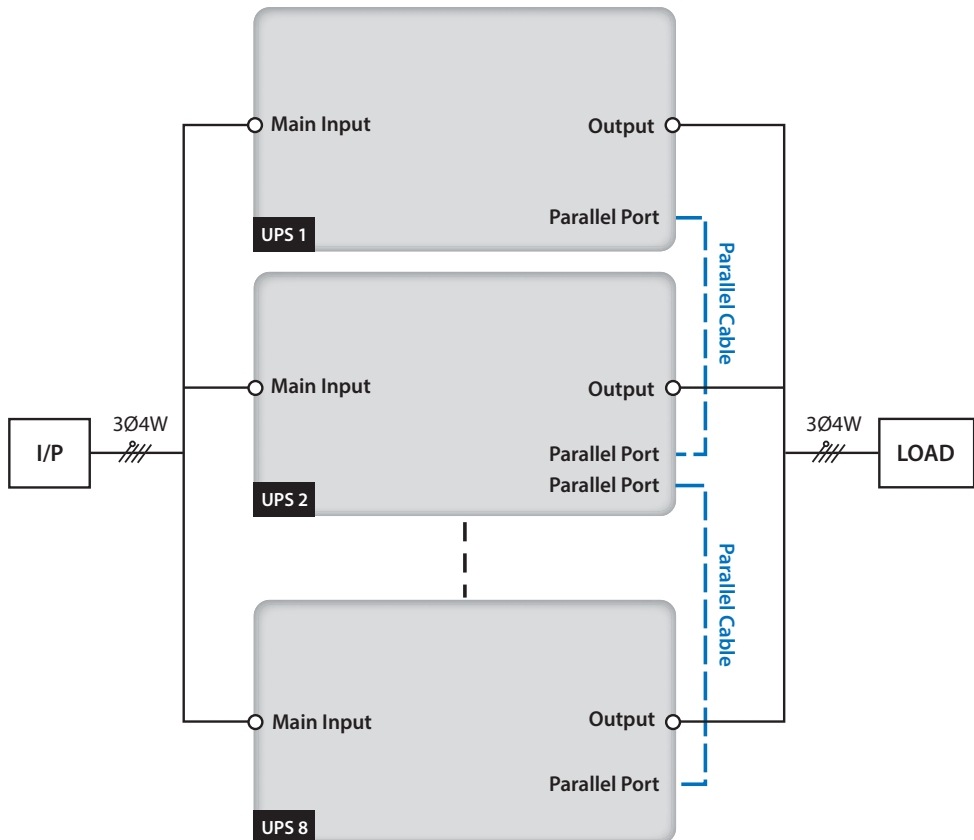

(Figure 5-15: Parallel Units Single Input Wiring Diagram)

- **Dual Input (Parallel Units)**

When there are two AC power sources, parallel units' wiring procedures are as follows.

- ① Follow **5.5.2 Single Input/ Dual Input Modification** to modify the parallel UPSs into dual input.
- ② Follow the procedures ① ~ ⑥ stated in the section of **Single Input (Single Unit)**.

- 3) Connect the main AC source/ bypass AC source/ UPS output/ external battery cabinet cables to the wiring terminal block. Please refer to **Figure 5-14**, **Figure 5-16** and **5.6 External Battery Cabinet Connection Warnings**.
- 4) Use the provided parallel cable to connect the parallel ports on the parallel units. Please see **Figure 4-1** for parallel port location.
- 5) Ground the parallel UPSs.



WARNING:

1. When UPSs are paralleled, the length of each unit's input cables (bypass AC source) plus output cables must be the same. This ensures that the parallel UPSs can equally share the critical loads in bypass mode.
2. Only UPSs with the same capacity, voltage and frequency can be paralleled; otherwise, parallel functions will fail.

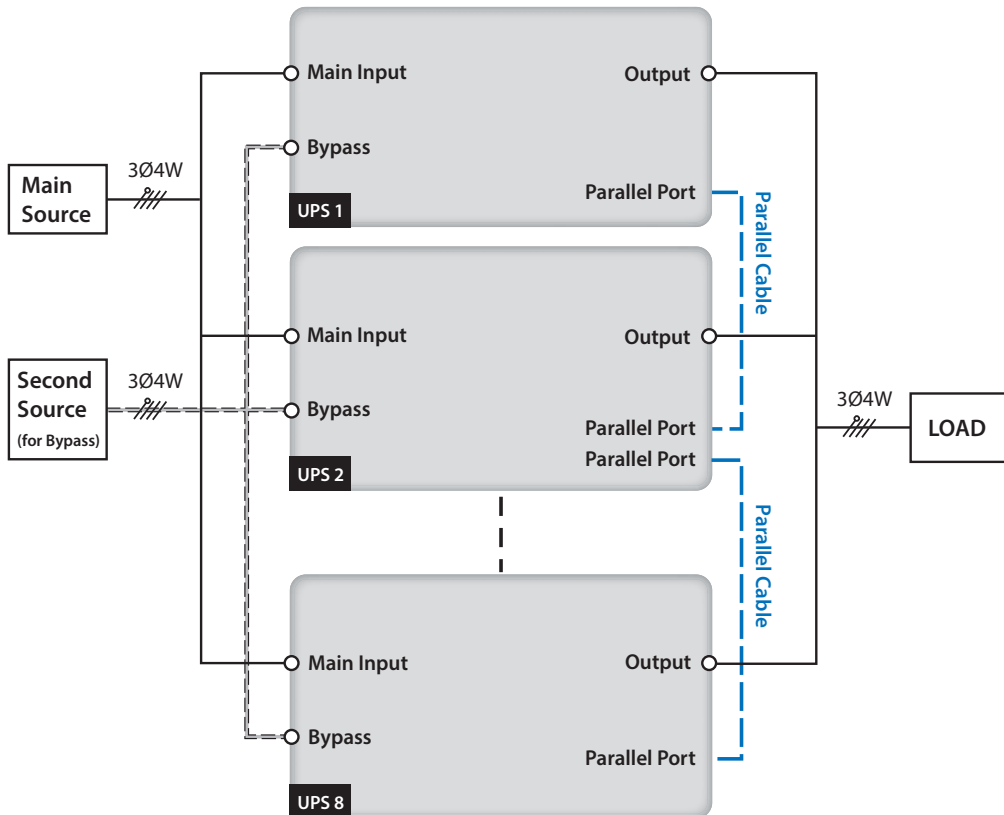

(Figure 5-16: Parallel Units Dual Input Wiring Diagram)

5.6 External Battery Cabinet Connection Warnings

You should connect the DPS series UPS with at least one external battery cabinet to ensure that the critical loads connected are protected when a power failure occurs. You can connect at maximum four external battery cabinets to the UPS.

- To ensure that the batteries are fully charged, please charge the batteries at least 8 hours before initial use of the UPS. The charging procedures are as follows.
 1. Connect the UPS to an AC power source and the external battery cabinet. Please see **5. Installation and Wiring**.
 2. Follow **6. UPS Operation** to turn on the UPS and the external battery cabinet. After the UPS is turned on, the unit will automatically charge the batteries.



WARNING:

You can connect the critical loads to the UPS only after the batteries are fully charged. This guarantees that the UPS can provide sufficient backup power to the critical loads connected when a power failure occurs.

- **Battery**

1. Charge voltage:
 - 1) Float voltage: $\pm 272\text{Vdc}$ (default)
 - 2) Boost voltage: $\pm 288\text{Vdc}$ (default)
2. Charge Current:
 - 1) Min: $\pm 5\text{A}$
 - 2) Max: $\pm 130\text{A}$
 - 3) Default: 10A



NOTE: If you want to modify the charge current default setting, please contact your local dealer or customer service.

3. Low Battery Shutdown: $\pm 190\sim 220\text{Vdc}$ (default: 200Vdc)



NOTE: If you want to modify the low battery shutdown default setting, please contact your local dealer or customer service.

4. The number of batteries: $12\text{V} \times 40\text{ PCS}$



NOTE: You can also choose $12\text{V} \times 38\text{ PCS}$ or $12\text{V} \times 42\text{ PCS}$ batteries. Please contact your local dealer or customer service for battery selection, installation and replacement.

- Only use the same type of batteries from the same supplier. Never use old, new and different Ah batteries at the same time.
- The number of batteries must meet UPS requirements.
- Do not connect the batteries in reverse.
- Use a voltage meter to measure whether the total voltage, after battery connection, is around $12.5\text{Vdc} \times$ the total number of batteries.
- The default number of batteries is 40 pcs of 12V batteries connected in string, and you should connect the external battery cabinet's neutral to the middle 20th and 21st batteries. You should use battery cables to connect the external battery cabinet with the '+', '-', and 'N' terminals marked on the UPS. Please refer to **Figure 5-17**.

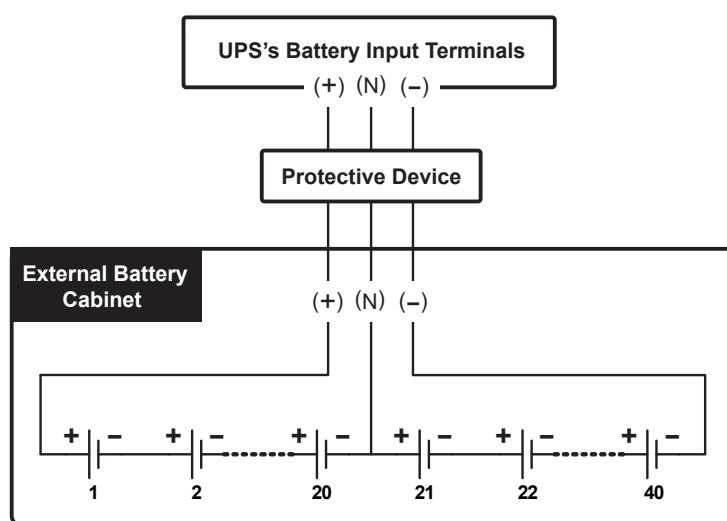

(Figure 5-17: External Battery Cabinet Connection)



WARNING:

A battery leak can short-circuit the batteries and lead to serious accidents. For safety's sake, you must insulate the batteries from their touched metal cabinets by installing insulated devices (e.g. insulated trays or boxes) in between. For relevant information about the insulated materials for such application, please contact Delta customer service.

- Please follow your UPS rating to install an appropriate protective device for each external battery cabinet. There are four installation methods for selection.
 - (1) A 4-pole DC circuit breaker or DC isolated switch connected in series with a DC fuse
 - (2) A 3-pole DC circuit breaker or DC isolated switch connected in series with a DC fuse
 - (3) A 4-pole DC circuit breaker
 - (4) A 3-pole DC circuit breaker

For relevant values, please refer to **Table 5-3**; for relevant installation diagrams, please refer to **Figure 5-19 ~ Figure 5-22**.

Table 5-3: External Battery Cabinet’s Protective Device
(Battery Default Q’ty: 12Vdc × 40 PCS)

| UPS Rating | 4-Pole DC Circuit Breaker or 4-Pole DC Isolated Switch (Per Pole Voltage ≥ 250Vdc) | 3-Pole DC Circuit Breaker or 3-Pole DC Isolated Switch (Per Pole Voltage ≥ 500Vdc) | DC Fuse (Voltage ≥ 500Vdc) | Battery Cable |
|------------|--|--|----------------------------|--|
| 160kVA | 400A | 400A | 400A | 70mm ² × 2 PCS or 240mm ² × 1 PC or 000kcmil × 2 PCS or 500kcmil × 1 PC |
| 200kVA | 500A | 500A | 500A | 95mm ² × 2 PCS or 300mm ² × 1 PC or 0000kcmil × 2 PCS or 600kcmil × 1 PC |



NOTE:

1. **Table 5-3** is based on 12Vdc × 40 PCS batteries (default). If you install a different number of batteries, please contact Delta service personnel for protective device’s current and voltage.
2. The above-mentioned DC circuit breaker, DC isolated switch and DC fuse are optional. If you want to buy any of them, please contact Delta service personnel.
3. If you need to parallel multiple units of external battery cabinets, please contact Delta service personnel for relevant information.
4. To extend backup time, you can parallel up to four units of external battery cabinets to the UPS. Please note that (1) the number of batteries in each of the parallel external battery cabinets and (2) the cable length of each string of the batteries must be the same.

- Please follow **Table 5-3: External Battery Cabinet's Protective Device (Battery Default Q'ty: 12Vdc x 40 PCS)** and **Figure 5-18: External Battery Cabinet Wiring** to connect an external battery cabinet to the UPS. Please note that only authorized Delta engineers or service personnel can perform wiring or you can perform wiring only under the supervision of authorized Delta engineers or service personnel.

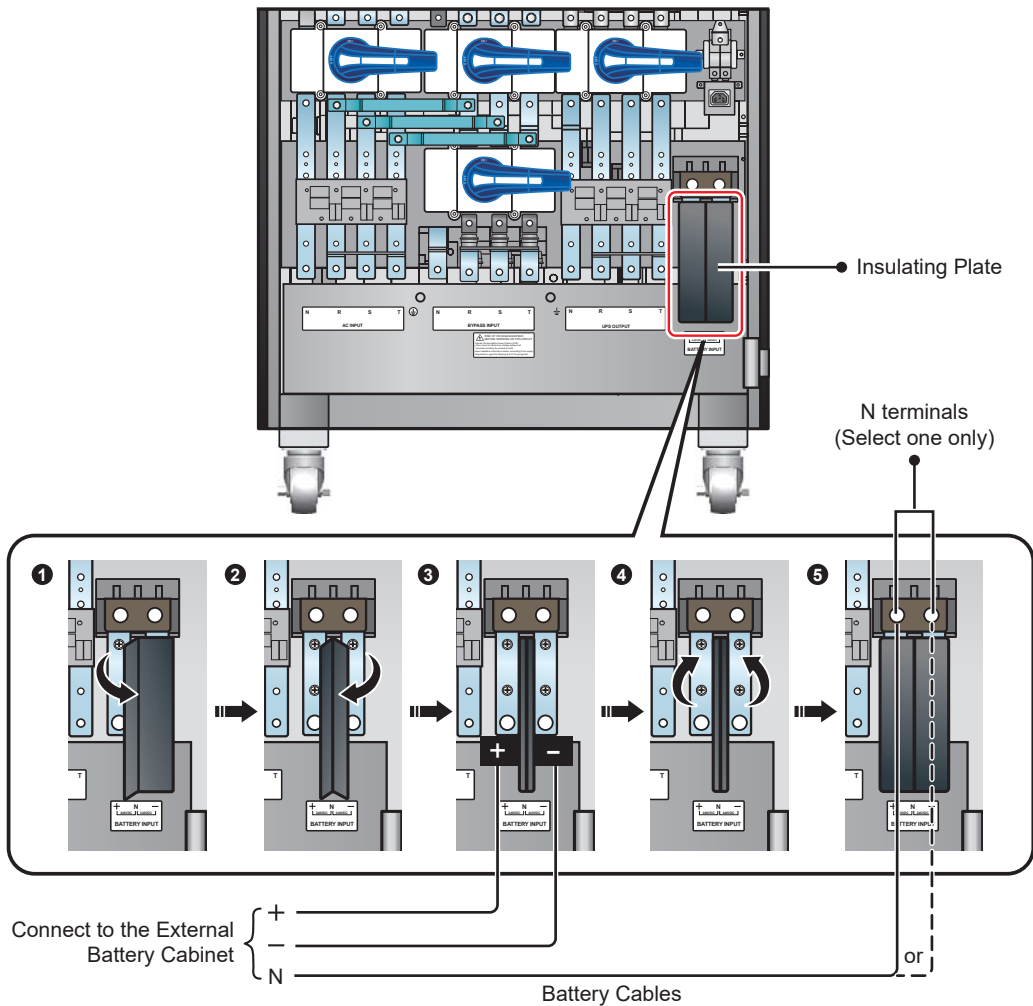

(Figure 5-18: External Battery Cabinet Wiring)

- To save on your costs and installation space, the parallel UPSs can share their connected external battery cabinet(s). Please refer to **3.10 Common Battery**.
- The external battery cabinet's protective device must be planned and designed by qualified service personnel. For installation of the external battery cabinet's protective device, there are four selections, which are (1) a 4-pole DC circuit breaker or DC isolated switch connected in series with a DC fuse, (2) a 3-pole DC circuit breaker or DC isolated switch connected in series with a DC fuse, (3) a 4-pole DC circuit breaker and (4) a 3-pole DC circuit breaker. For relevant values, please refer to **Table 5-3**. When choosing the external battery cabinet's protective device, please take the following factors into consideration: (1) over current between the UPS and battery circuit, (2) short circuit, (3) wire/ cable materials, and (4) local electrical regulations. If you have any questions about the external battery cabinet's protective device, please contact Delta service personnel. For installation methods of the external battery cabinet's protective device, please refer to **Figure 5-19 ~ Figure 5-22**.
- The protective device is optional, and its type must be fast-acting DC circuit breaker or/ and fast-acting DC fuse. When choosing the protective device, please follow the instructions below.
 - (1) The protective device's rated current must comply with the current values shown in **Table 5-3**.
 - (2) The specifications of the protective device's short-circuit protection (i.e. the tripping current of the fast-acting DC circuit breaker or/ and the melting current of the fast-acting DC fuse) must be 4~6 times the values shown in **Table 5-3**. Besides, the response time of the protective device must be less than 20ms.
 - (3) For the choice of the fast-acting DC fuse mentioned above, the A50QS series from the supplier **Ferraz Shawmut** is suggested. Please contact Delta customer service for relevant information.
 - (4) The maximum tripping current of the fast-acting DC circuit breaker or/ and the maximum melting current of the fast-acting DC fuse mentioned above are 6 times the values shown in **Table 5-3**. These maximum values are suggested for general applications only. For actual maximum values, the maximum short-circuit capacity of the on-site batteries must be taken into consideration. Please contact Delta customer service for relevant information.

- The external battery cabinet's protective device installation methods are as follows.

Option 1: Installation of a 4-pole DC circuit breaker or DC isolated switch (per pole voltage $\geq 250\text{Vdc}$) connected in series with a DC fuse (voltage $\geq 500\text{Vdc}$)

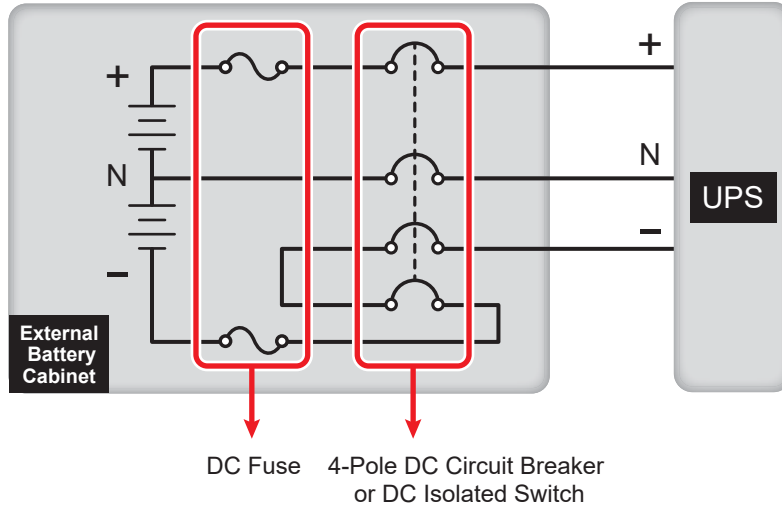

(Figure 5-19: Installation of a 4-Pole DC Circuit Breaker or DC Isolated Switch Connected in Series with a DC Fuse)

Option 2: Installation of a 3-pole DC circuit breaker or DC isolated switch (per pole voltage $\geq 500\text{Vdc}$) connected in series with a DC fuse (voltage $\geq 500\text{Vdc}$)

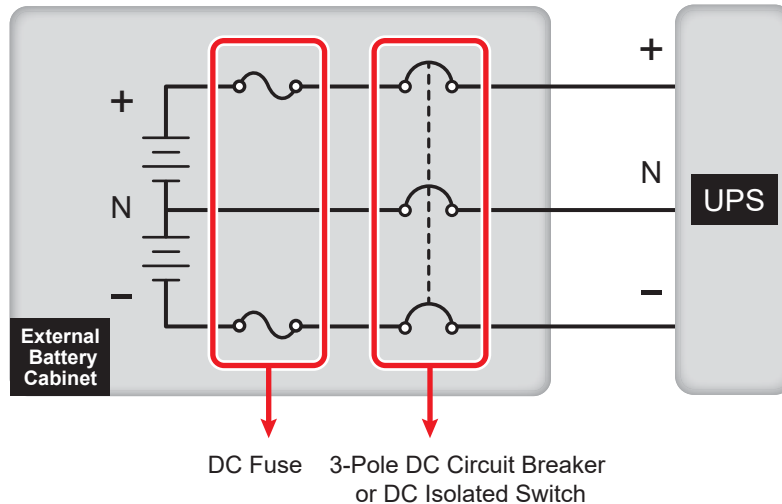

(Figure 5-20: Installation of a 3-Pole DC Circuit Breaker or DC Isolated Switch Connected in Series with a DC Fuse)

Option 3: Installation of a 4-pole DC circuit breaker (per pole voltage $\geq 250\text{Vdc}$)

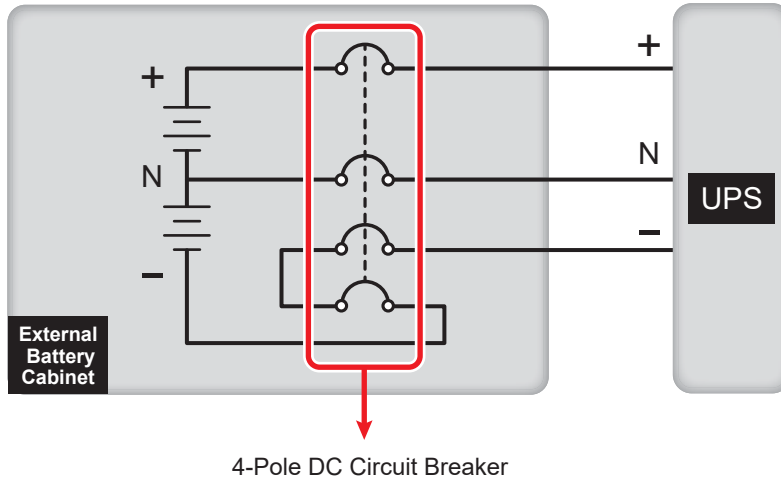

(Figure 5-21: Installation of a 4-Pole DC Circuit Breaker)

Option 4: Installation of a 3-pole DC circuit breaker (per pole voltage $\geq 500\text{Vdc}$)

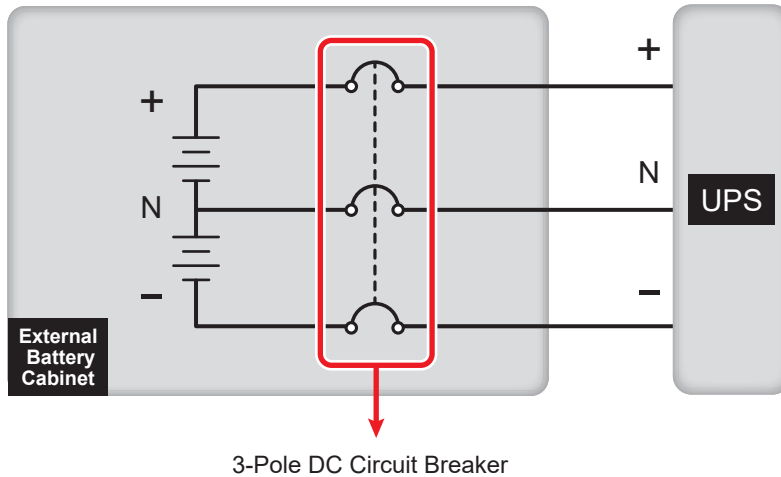

(Figure 5-22: Installation of a 3-Pole DC Circuit Breaker)



NOTE:

1. Before performing battery/ battery cabinet replacement, please turn off each external battery cabinet's breaker to completely disconnect the battery power from the UPS.
2. A battery can present a risk of electric shock and high short-circuit current. Servicing of batteries and battery cabinets must be performed or supervised by qualified personnel knowledgeable in batteries, battery cabinets and required precautions. Keep unauthorized personnel away from batteries and battery cabinets.

- **External Battery Cabinet Alarm**

When an external battery cabinet connected to the UPS has the following problems, the UPS system will sound an alarm. Please see the table below.

| No. | External Battery Cabinet Status | Alarm |
|------------|--|--|
| 1 | Battery Ground Fault | Long beep. |
| 2 | Battery Cabinet Over Temp | Sounds every 0.5 second (Beep is ON for 0.25 second & Beep is OFF for 0.25 second). |
| 3 | Battery Test Fail | Sounds every 10 seconds (Beep is ON for 0.5 second & Beep is OFF for 9.5 seconds). |
| 4 | Battery Low Warning | Sounds every 0.5 second (Beep is ON for 0.25 second & Beep is OFF for 0.25 second). |
| 5 | Battery Low Shutdown | Sounds every 3 seconds (Beep is ON for 0.5 second & Beep is OFF for 2.5 seconds). |
| 6 | Battery Replacement | Sounds every 10 seconds (Beep is ON for 0.5 second & Beep is OFF for 9.5 seconds). |
| 7 | Battery Over Charge | Long beep. |
| 8 | Battery Missing | Sounds every 0.5 second (Beep is ON for 0.25 second & Beep is OFF for 0.25 second). |
| 9 | Battery Breaker Off | Sounds every 0.5 second (Beep is ON for 0.25 second & Beep is OFF for 0.25 second). |

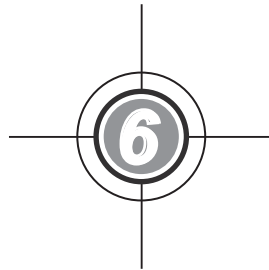

UPS Operation

- 6.1 Single Unit Operation Procedures
- 6.2 Parallel Units Operation Procedures



NOTE:

All of the unit No., date, time, and event No. (e.g. 004) shown in the LCD diagrams presented in this section are for reference only. Actual readings depend on the operation of the UPS.

6.1 Single Unit Operation Procedures

- **Pre Start-up Warnings for Single Unit**

1. Make sure all switches including the circuit breakers or fuses of all external battery cabinets are switched to the OFF position.
2. Ensure that the voltage difference between the Neutral (N) and the Ground (\oplus) is < 3V.
3. Check if the wiring is correct and the AC power source's voltage, frequency, phase and battery type meet UPS requirements.
4. Inspect if the auxiliary power fuse holder is closed. Please see **Figure 6-1**.

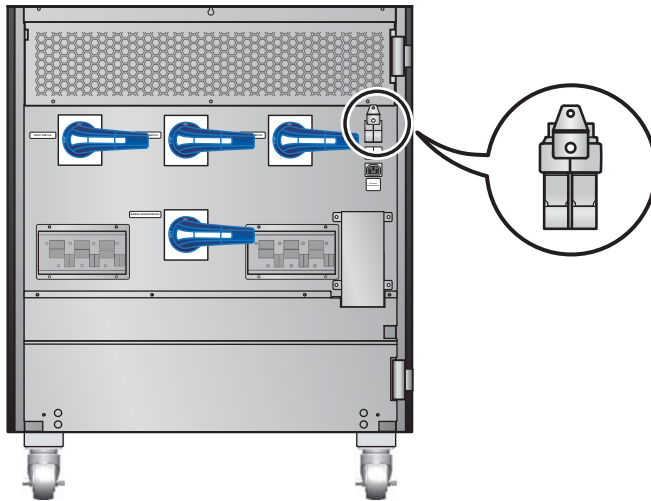



(Figure 6-1: Close the Auxiliary Power Fuse Holder)

- **Pre Turn-off Warnings for Single Unit**

If you perform turn-off procedures for single unit, all power supplies will be completely cut off. Please make sure the critical loads connected to the UPS have already been safely shutdown before you perform the turn-off procedures.

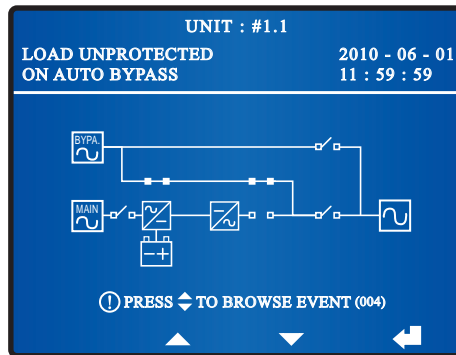

6.1.1 Normal Mode Start-up Procedures (Single)

- ① Switch on the circuit breakers or fuses of all external battery cabinets, and ensure that the Manual Bypass Switch (Q3) is in the OFF position.
- ② Switch on the Bypass Switch (Q2). After initialization, all fans start running, the Bypass AC Source LED  and the Bypass Power Supply LED  illuminate, and the following screen appears.



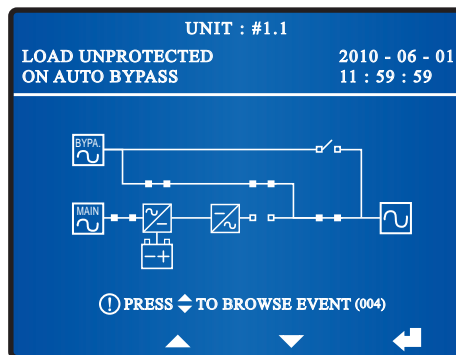

- ③ Turn on the Output Switch (Q4), the Output Switch LED  illuminates and the following screen appears. Now the bypass supplies power to the output.

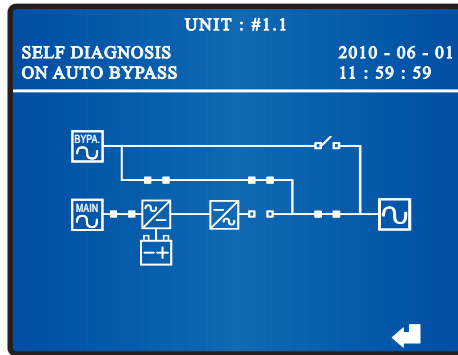

- 4 Turn on the Input Switch (Q1), the Main AC Source LED  illuminates, and the UPS's DC BUS voltage starts establishing.
- 5 Press the **ON** button  on the control panel for three to ten seconds and release it after you hear one beep. The following screen appears.



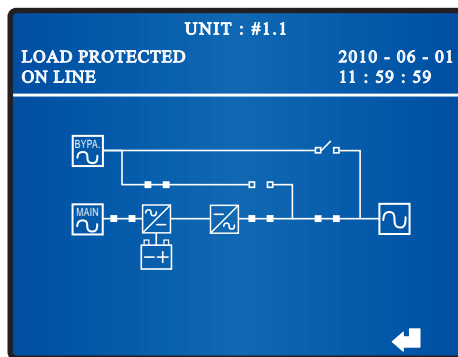

- 6 During start-up testing period, the system starts up the inverter and the Inverter Start-up LED  lights up. The system begins synchronization with the bypass AC source.
- 7 After synchronization, the UPS will automatically switch from bypass mode to inverter mode, and the inverter will supply power to the output. In the meantime, the Bypass Power Supply LED  shuts off, the Inverter Power Supply LED  illuminates and the following screen appears.



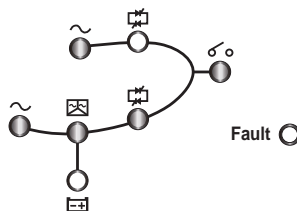



- 8 After you complete the normal mode start-up procedures, LEDs illuminate as follows.

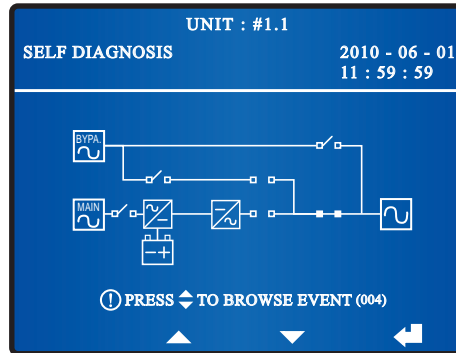

6.1.2 Battery Mode Start-up Procedures (Single)

- 1 Switch on the circuit breakers or fuses of all external battery cabinets, ensure the Manual Bypass Switch (Q3) is in the **OFF** position, and turn on the Output Switch (Q4).
- 2 Press the **ON** button  on the control panel for three to ten seconds and release it after you hear one beep. The Output Switch LED  lights up and the following screen appears.



- 3 The UPS's power module starts running and the DC BUS voltage starts establishing. After that, the inverter will start up with default frequency. During the inverter start-up process, the Inverter Start-up LED  and the Battery Power Supply LED  illuminate.
- 4 After the inverter starts up, the UPS will transfer to battery mode. At this moment, all fans start running, the Inverter Power Supply LED  lights up and the following screen appears.

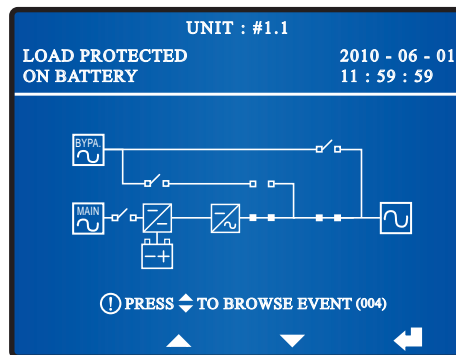

- 5 After you complete the battery mode start-up procedures, LEDs illuminate as follows.

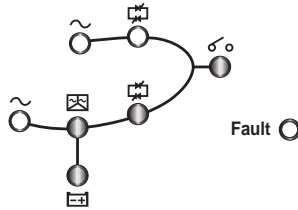

6.1.3 Bypass Mode Start-up Procedures (Single)

- 1 Switch on the Bypass Switch (Q2). After initialization, all fans start running, the Bypass AC Source LED \sim and the Bypass Power Supply LED ⏏ illuminate, and the following screen appears.

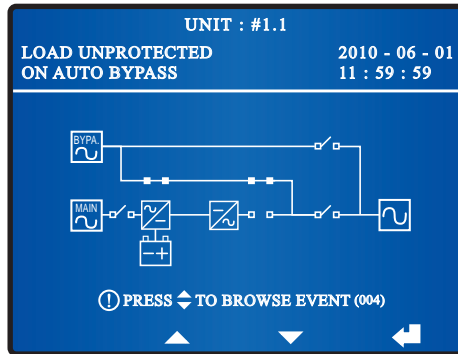

- 2 Turn on the Output Switch (Q4). The Output Switch LED ⏏ illuminates and the following screen appears. The bypass supplies power to the output.

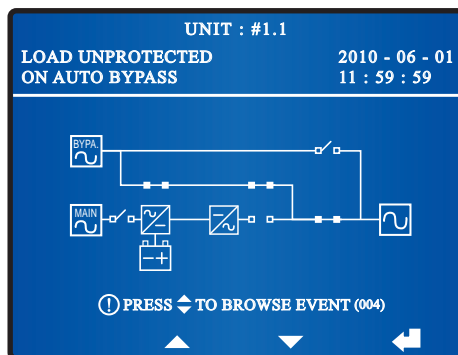

- 3 After you complete the bypass mode start-up procedures, LEDs illuminate as follows.

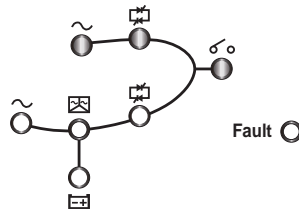

6.1.4 Manual Bypass Mode Start-up Procedures (Single Unit)







WARNING:

1. Please note that you can only turn on the Manual Bypass Switch (Q3) when the UPS needs maintenance. This ensures that the supply of power to the critical loads will continue. If you turn on the Manual Bypass Switch (Q3) during normal mode, the inverter will shut down, the UPS will transfer from normal mode to manual bypass mode, and the output won't be protected.
2. In manual bypass mode, the manual bypass supplies power to the critical loads and maintenance personnel can perform maintenance without interrupting the power supply to the loads.
3. When the UPS is in manual bypass mode, there is no high voltage inside the UPS except the wiring terminal block and the Manual Bypass Switch (Q3). Do not touch the wiring terminal.

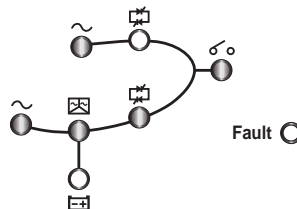
• From Normal Mode to Manual Bypass Mode (Single)

- 1 During normal mode, LEDs illuminate as follows.



- 2 Press the **OFF** button  on the control panel for three to ten seconds and release it after you hear one beep. The LCD will show the message: '**SHUTDOWN UPS?**'. Select '**YES**' and press the function key below the symbol '' to confirm your selection. At this moment, the UPS transfers to bypass mode, the Inverter Start-up LED  and the Inverter Power Supply LED  shuts off, and the following screen appears.

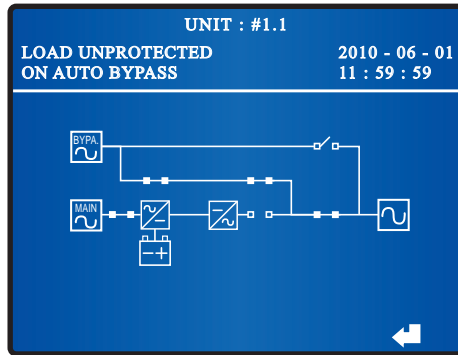

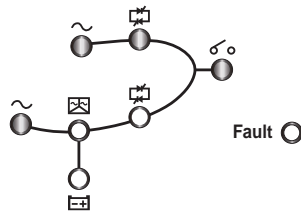

3) Check if LEDs illuminate as follows to ensure that the UPS is in bypass mode.

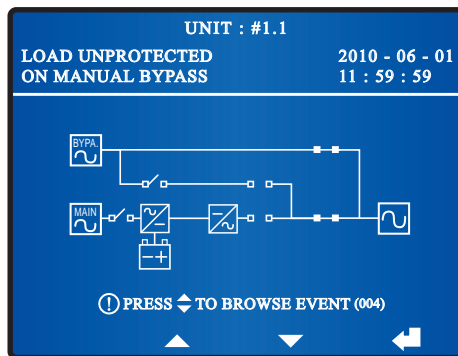

4) Turn on the Manual Bypass Switch (Q3) and turn off the Input Switch (Q1) and Bypass Switch (Q2). All LEDs are off and the following screen appears.



5) When the UPS's power module performs discharging, the Inverter Start-up LED  illuminates. After the power module finishes discharging, the Inverter Start-up LED  turns off, the UPS shuts down, and no screen appears.

6) Turn off the Output Switch (Q4) and switch off the circuit breakers or fuses of all external battery cabinets.

7) Open the auxiliary power fuse holder.

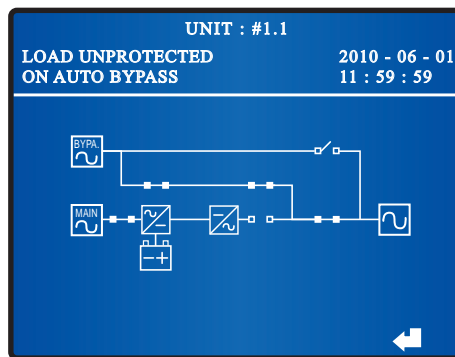

- **From Manual Bypass Mode to Normal Mode (Single)**

- ① Close the auxiliary power fuse holder.
- ② Switch on the circuit breakers or fuses of all external battery cabinets.
- ③ Turn on the Input Switches (Q1), the Bypass Switch (Q2) and the Output Switch (Q4). After initialization, all fans start running and the UPS's DC BUS voltage starts establishing.
- ④ Switch off the Manual Bypass Switch (Q3). The bypass supplies power to the critical loads, the following screen appears and LEDs illuminate as follows.

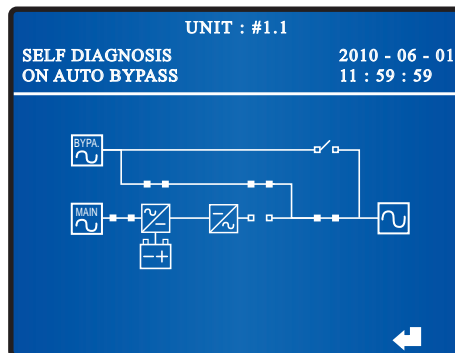

- ⑤ Press the **ON** button  on the control panel for three to ten seconds and release it after you hear one beep. The following screen appears.



- ⑥ During the start-up testing period, the system starts up the inverter, the Inverter Start-up LED  lights up, and the system begins synchronization with the bypass AC source.
- ⑦ After synchronization, the UPS will automatically switch from bypass mode into inverter mode, and the inverter will supply power to the output. In the meantime, the Bypass Power Supply LED  turns off, the Inverter Power Supply LED  illuminates, and the following screen appears.

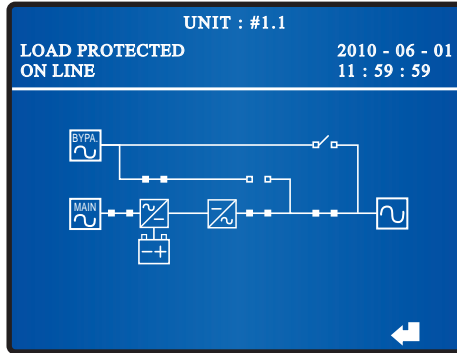

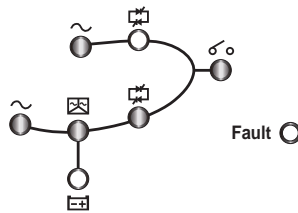

8) During normal mode, LEDs illuminate as follows.



6.1.5 Normal Mode Turn-off Procedures (Single)

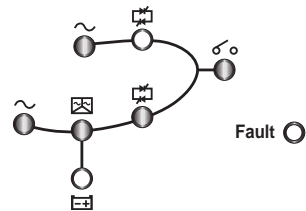
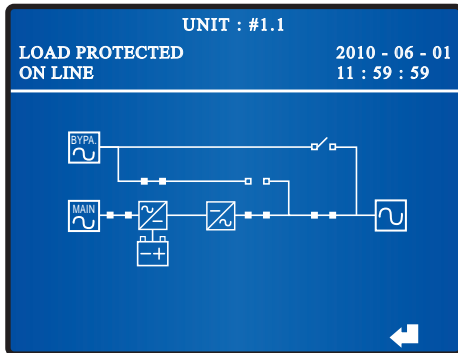

1) During normal mode, the following screen appears and LEDs illuminate as follows.

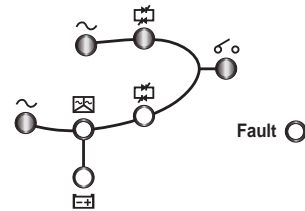
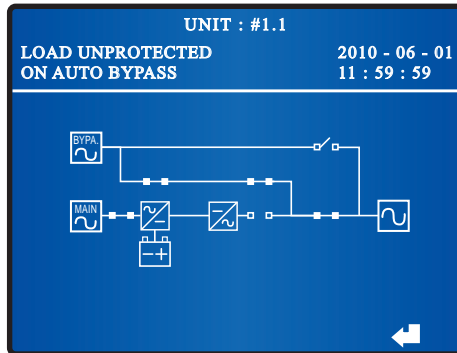

2) Press the **OFF** button  on the control panel for three to ten seconds and release it after you hear one beep. The LCD shows the message: '**SHUTDOWN UPS?**'. Select '**YES**' and press the function key below the symbol  to confirm your selection.

3) After you confirm your selection, the UPS transfers from normal mode into bypass mode, the following screen appears and LEDs illuminate as follows.





- 4 Switch off the Input Switch (Q1) and the Main AC Source LED  shuts off.
- 5 When the UPS's power module performs discharging, the Inverter Start-up LED  illuminates. After the power module finishes discharging, the Inverter Start-up LED  shuts off.
- 6 Turn off the circuit breakers or fuses of all external battery cabinets and turn off the Bypass Switch (Q2) and the Output Switch (Q4). All LEDs are off and no screen appears.

6.1.6 Battery Mode Turn-off Procedures (Single)

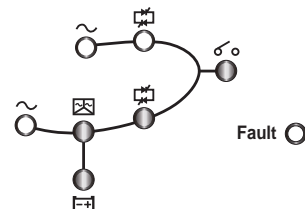
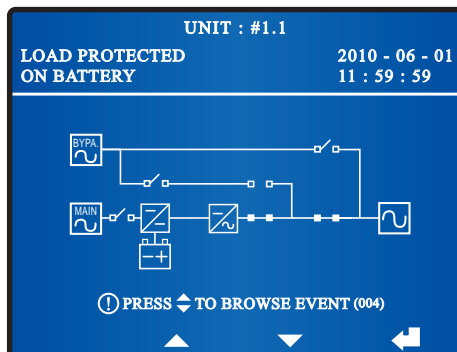
- 1 During battery mode, the following screen appears and LEDs illuminate as follows.



- 2 Press the **OFF** button  on the control panel for three to ten seconds and release it after you hear one beep. The LCD shows the message: 'SHUTDOWN UPS?'. Select 'YES' and press the function key below the symbol  to confirm your selection.
- 3 After you confirm your selection, the UPS turns off the inverter and cuts off the output. The following screen appears and LEDs illuminate as follows.

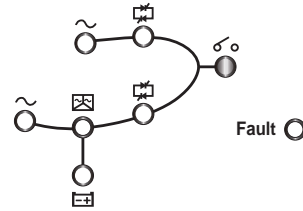
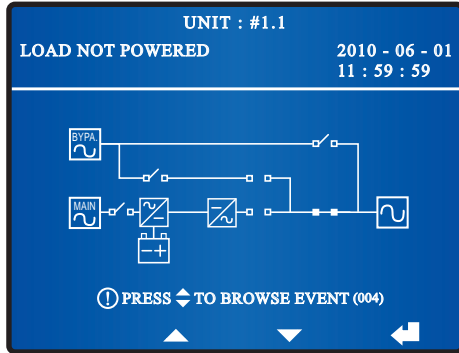

- 4 When the power module performs discharging, the Inverter Start-up LED lights up. After the power module finishes discharging, the Inverter Start-up LED shuts off.
- 5 Turn off the Output Switch (Q4). All LEDs are off, and after 30 seconds, the LCD shuts down.
- 6 Switch off the circuit breakers or fuses of all external battery cabinets to discontinue power supply to the UPS.

6.1.7 Bypass Mode Turn-off Procedures (Single)

- 1 During bypass mode, the following screen appears and LEDs illuminate as follows.

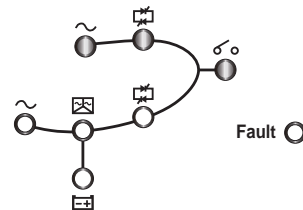
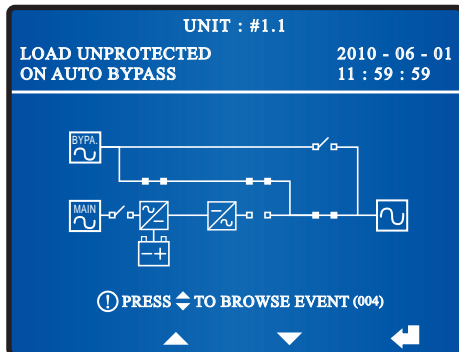

- 2 Turn off the Bypass Switch (Q2). When the power module performs discharging, the Inverter Start-up LED lights up. After the power module finishes discharging, the Inverter Start-up LED shuts off.
- 3 Turn off the circuit breakers and fuses of all external battery cabinets and switch off the Output Switch (Q4).

6.1.8 Manual Bypass Mode Turn-off Procedure (Single)

During manual bypass mode, no LED illuminates and no screen appears on the LCD. Just turn off the Manual Bypass Switch (Q3) to shut down the UPS.

6.2 Parallel Units Operation Procedures

- **Pre Start-up Warnings for Parallel Units**

1. Make sure all switches including the circuit breakers or fuses of all external battery cabinets are switched to the OFF position.
2. Ensure that the voltage difference between the Neutral (N) and the Ground (\oplus) is < 3V.
3. Check if the wiring is correct and the AC power source's voltage, frequency, phase and battery type meet UPS requirements.
4. Inspect if the auxiliary power fuse holder is closed. Please see **Figure 6-2**.

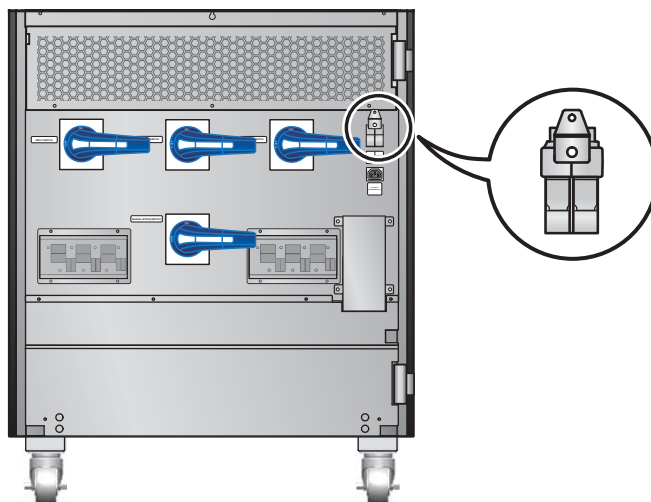

(Figure 6-2: Close the Auxiliary Power Fuse Holder)

5. Before paralleling UPSs, please confirm that each unit's capacity, voltage and frequency are the same. After confirmation, use the provided parallel cable to connect the UPSs and make sure the parallel cable is firmly fixed.

- **Pre Turn-off Warnings for Parallel Units**

1. If you want to turn off one of the parallel UPSs, please check whether the remaining parallel UPSs' total capacity exceeds the total critical loads. If the remaining parallel UPSs' total capacity is less than the total critical loads, it will be the bypass that supplies power to the critical loads. Once a power event occurs, your critical loads won't be protected.
2. If you perform turn-off procedures for all parallel UPSs, all power supplies will be completely cut off. Please make sure the critical loads connected to the parallel UPSs have already been safely shutdown before you perform the turn-off procedures.

- **Parallel Switch Operation Warning**

1. UPSs only with the same capacity, voltage and frequency can be paralleled.
2. If you want to parallel UPSs (at maximum eight), you should use the control panel to set each UPS's parallel group ID No. and parallel ID No. Please see **7.7.5 Parallel Setup**.
3. When paralleling UPSs, you should set up the parallel switch marked in the circle shown in **Figure 6-3**. The parallel switch includes two DIP switches. To turn on a DIP switch, set the DIP switch to the down position. To turn off a DIP switch, set the DIP switch to the up position.
 - 1) When two UPSs are paralleled, turn on each UPS's DIP switches.
 - 2) When three UPSs are paralleled, turn off the middle UPS's DIP switches and turn on the remaining UPSs' DIP switches.
 - 3) When four UPSs are paralleled, turn off the middle two UPSs' DIP switches and turn on the remaining UPSs' DIP switches.
 - 4) When five UPSs are paralleled, turn off the middle three UPSs' DIP switches and turn on the remaining UPSs' DIP switches.
 - 5) When six UPSs are paralleled, turn off the middle four UPSs' DIP switches and turn on the remaining UPSs' DIP switches.
 - 6) When seven UPSs are paralleled, turn off the middle five UPSs' DIP switches and turn on the remaining UPSs' DIP switches.
 - 7) When eight UPSs are paralleled, turn off the middle six UPSs' DIP switches and turn on the remaining UPSs' DIP switches.

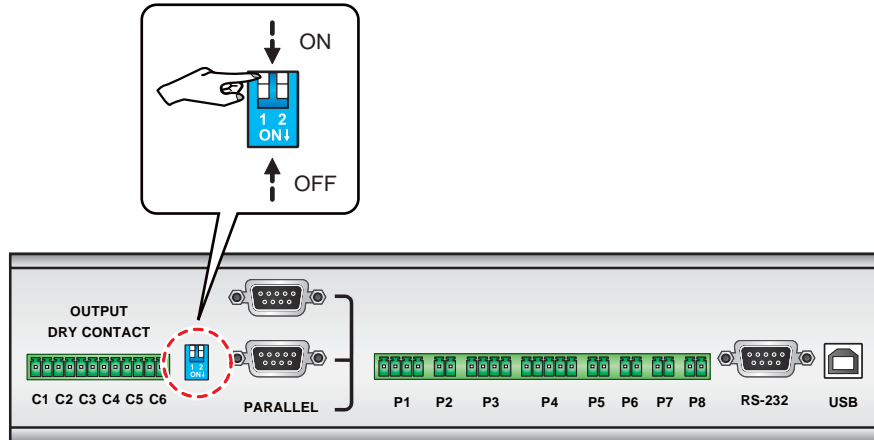



(Figure 6-3: Set up the Parallel Switch)



NOTE: The icon  shown in the LCD diagrams means that the UPS is in parallel mode.

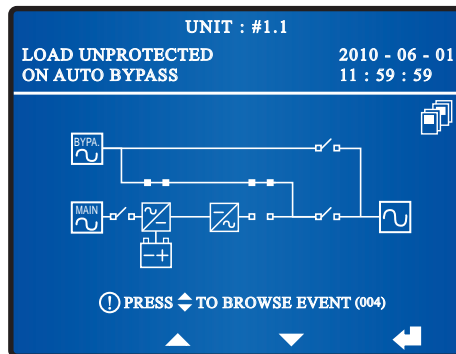

6.2.1 Normal Mode Start-up Procedures (Parallel)

- 1 Turn on the circuit breakers or fuses of all external battery cabinets.
- 2 Switch on the Bypass Switch (Q2). After initialization, all fans start running, the Bypass AC Source LED  and the Bypass Power Supply LED  illuminate, and the following screen appears.

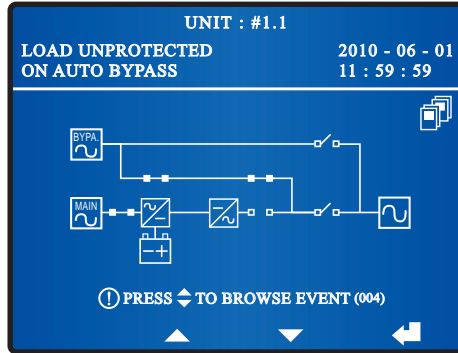

- 3 Turn on each UPS's Input Switch (Q1), each UPS's Main AC Source LED  illuminates, and each UPS's DC BUS voltage starts establishing.



- 4 Press each UPS's **ON** button  for three to ten seconds and release it after you hear one beep. In the meantime, each unit's inverter starts up, each unit's Inverter Start-up LED  is on, each UPS is in bypass mode, and the following screen appears on each unit's LCD.

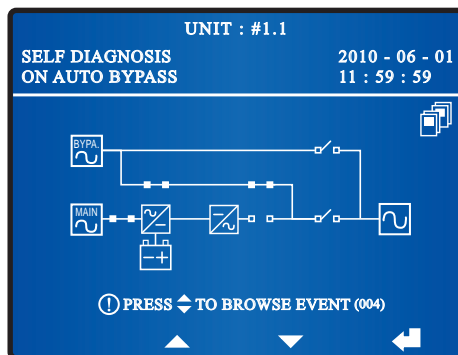

- 5 After each unit's inverter voltage establishes, all parallel UPSs will transfer to normal mode. At this moment, each UPS's Inverter Power Supply LED  illuminates and each UPS's LCD shows the following screen.

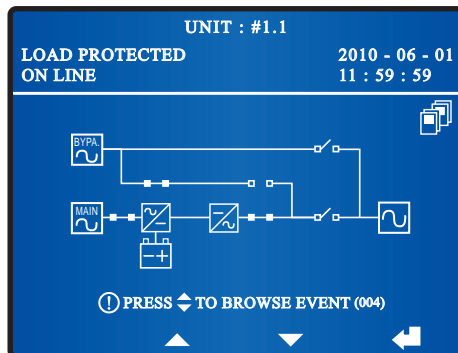

- 6 Measure each UPS's voltage difference between phases (should be below 5V). If normal, turn on each UPS's Output Switch (Q4). At this moment, each unit's Output Switch LED  lights on and each UPS's LCD shows the following screen. If abnormal, please contact maintenance personnel.

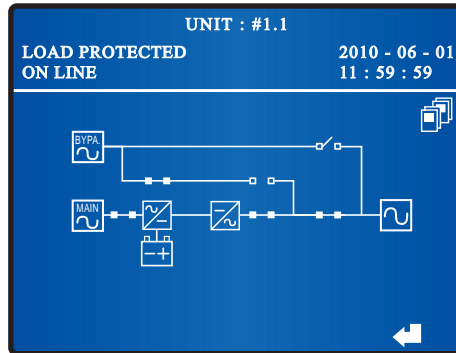



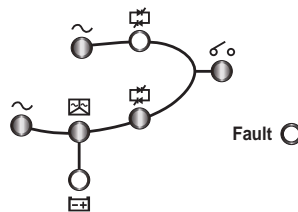

- 7 After you complete the normal mode start-up procedures, each UPS's LEDs illuminate as follows.

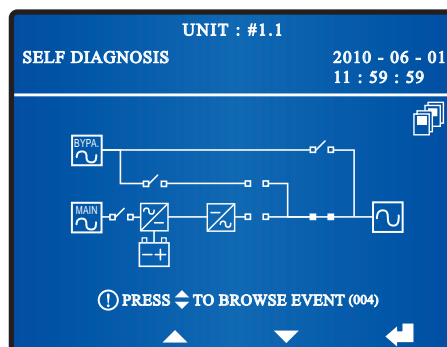

6.2.2 Battery Mode Start-up Procedures (Parallel)

- 1 Turn on the circuit breakers or fuses of all external battery cabinets. Turn off each UPS's Manual Bypass Switch (Q3) and turn on each unit's Output Switch (Q4).
- 2 Press each unit's **ON** button  on the control panel for three to ten seconds and release it after you hear one beep. Each UPS's LCD shows the following screen.



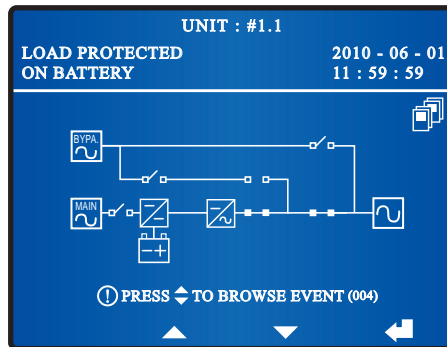

- 3) Each unit's power module starts running, DC BUS voltage begins establishing, and inverter starts up with the default frequency. During inverter start-up process, each unit's Inverter Start-up LED  and Battery Power Supply LED  illuminate
- 4) After each unit's inverter starts up, each UPS will transfer into battery mode. At this moment, all fans start running, each UPS's Inverter Power Supply LED  lights up and each UPS's LCD shows the following screen.



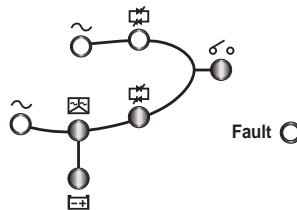

- 5) After you complete the battery mode start-up procedures, each unit's LEDs illuminate as follows.

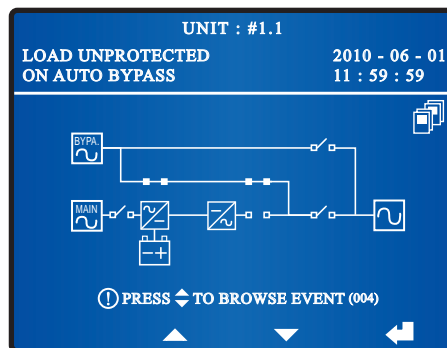

6.2.3 Bypass Mode Start-up Procedures (Parallel)

- 1) Switch on the Bypass Switch (Q2). After initialization, all fans start running, the Bypass AC Source LED  and the Bypass Power Supply LED  illuminate, and the following screen appears.



- 2 Turn on each unit's Output Switch (Q4). Each unit's Output Switch LED  illuminates and each unit's LCD shows the following screen. At this moment, the bypass supplies power to the output.

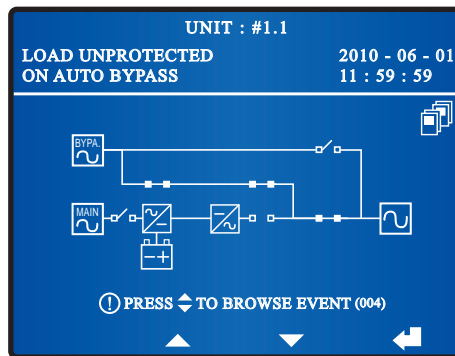

- 3 After you complete the bypass mode start-up procedures, each unit's LEDs illuminate as follows.

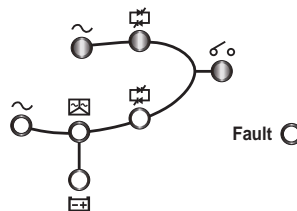



6.2.4 Manual Bypass Mode Start-up Procedures (Parallel)



WARNING:

1. Please note that you can only turn on the Manual Bypass Switch (Q3) when the UPS needs maintenance. This ensures that the supply of power to the critical loads will continue. If you turn on the Manual Bypass Switch (Q3) during normal mode, the inverter will shut down, the UPS will transfer from normal mode to manual bypass mode, and the output won't be protected.
2. In manual bypass mode, the manual bypass supplies power to the critical loads and maintenance personnel can perform maintenance without interrupting the power supply to the loads.
3. When the UPS is in manual bypass mode, there is no high voltage inside the UPS except the wiring terminal block and the Manual Bypass Switch (Q3). Do not touch the wiring terminal.

- **From Normal Mode to Manual Bypass Mode (Parallel)**

1) Press the **OFF** button  of one of the parallel UPSs for three to ten seconds and release it after you hear one beep. The LCD shows the message: **'SHUTDOWN UPS?'**. Select **'YES'** and press the function key below the symbol  to confirm your selection.

1) If the remaining parallel UPSs' total capacity exceeds the total critical loads, the inverter of the UPS that you turned off will automatically shut down, and the critical loads will be shared equally by the remaining parallel UPSs.

The status of LCD and LEDs for the UPS that you turned off:

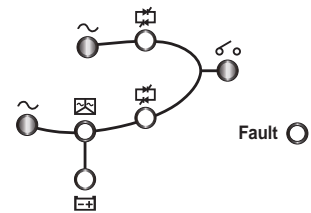
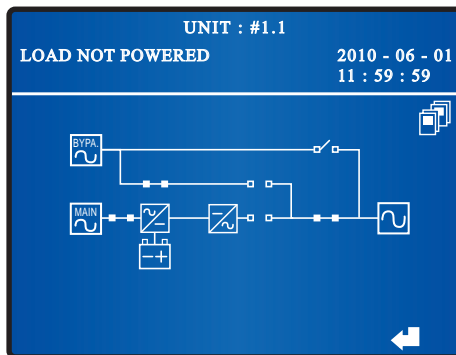

The status of LCD and LEDs for the remaining parallel UPSs:

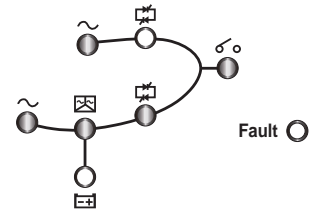
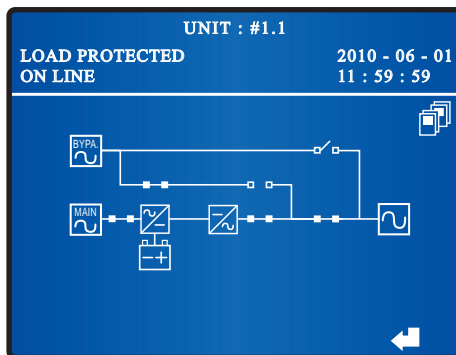

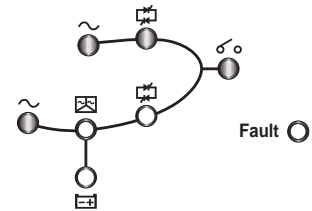
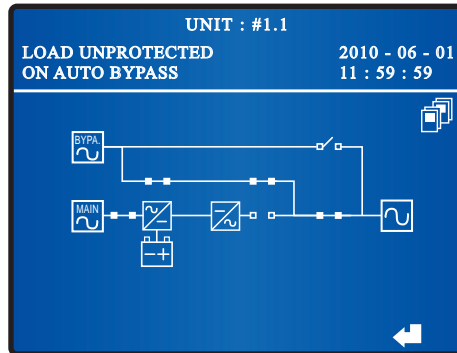

2) If the total critical loads exceed the remaining parallel UPSs' total capacity, all of the parallel UPSs' inverters will shut down, inverter static switches will automatically turn off, and all parallel UPSs will transfer to bypass mode. The total critical loads will be shared equally by all parallel UPSs, and the status of LCD and LEDs for each of the parallel UPSs is as follows.

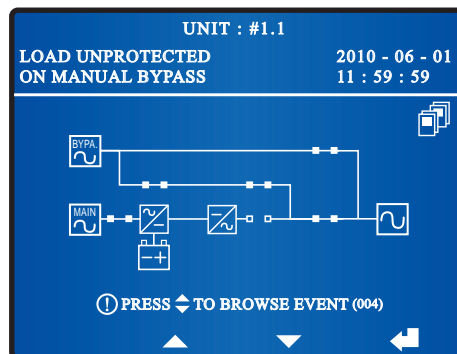

- ② If the UPS that you turned off matches 1) situation, repeat the procedures stated in ① to continually switch the remaining parallel UPSs into bypass mode.

If the UPS that you turned off matches 2) situation, please turn on each UPS's Manual Bypass Switch (Q3). After that, the manual bypass supplies power to the connected loads and each UPS's LCD shows 'LOAD UNPROTECTED ON MANUAL BYPASS' as follows.



- ③ Turn off each UPS's Input Switch (Q1), and each UPS's starts discharging. During the discharging process, each UPS's Inverter Start-up LED  illuminates. After discharging, per unit's Inverter Start-up LED  turns off.
- ④ Turn off each UPS's Bypass Switch (Q2). After that, the manual bypass supplies power to the connected loads and each UPS's LCD shows 'LOAD UNPROTECTED ON MANUAL BYPASS'.
- ⑤ Turn off each UPS's Output Switch (Q4) and all external battery cabinets' circuit breakers or fuses. Now, all fans stop running, and each UPS's LCD and LEDs shut down.
- ⑥ Open each UPS's auxiliary fuse holder.

- **From Manual Bypass Mode to Normal Mode (Parallel)**

- 1) Close each UPS's auxiliary power fuse holder.
- 2) Turn on all external battery cabinets' circuit breakers or fuses.
- 3) Switch on each unit's Bypass Switch (Q2) and Output Switch (Q4). After that, all fans start running. Each unit's LCD shows the following screen and each UPS's LEDs illuminate as follows.

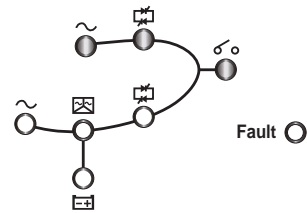
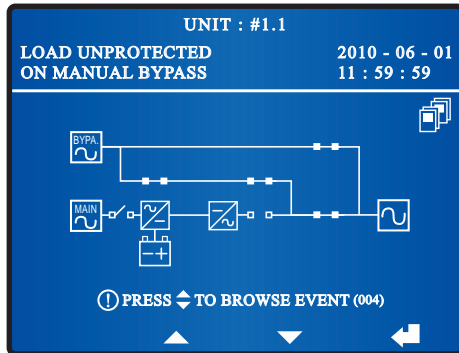

- 4) Turn off each UPS's Manual Bypass Switch (Q3). Per unit transfers into bypass mode, each UPS's LEDs illuminate without any change and each UPS's LCD shows the following screen.

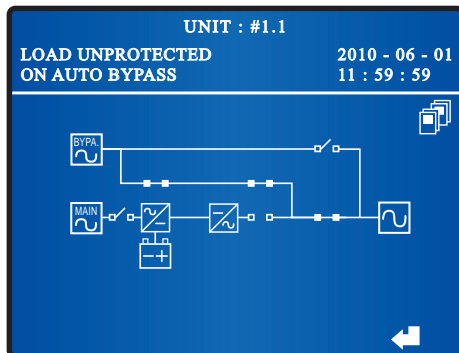

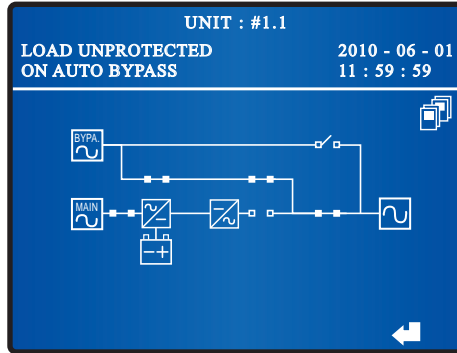

- 5) Turn on each UPS's Input Switch (Q1), each unit's Main AC Source LED ~ illuminates, and each UPS's LCD shows the following screen.



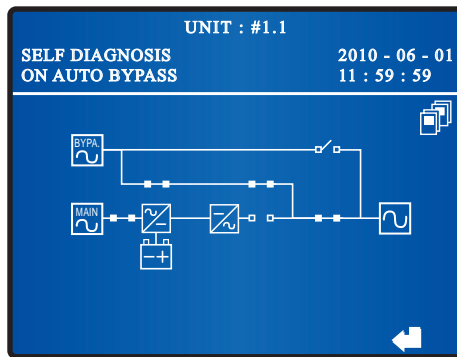

- 6 Press each UPS's **ON** button  on the control panel for three to ten seconds and release it after you hear one beep. At this moment, each UPS's LEDs illuminate without any change and each unit's LCD shows the following screen.

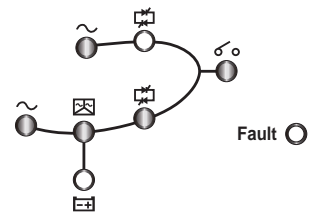
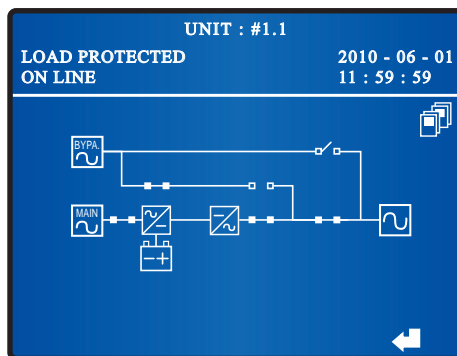

- 7 After each UPS's inverter voltage establishes, all parallel UPSs will transfer into normal mode. At this moment, each UPS's Bypass Power Supply LED  turns off, each UPS's Inverter Start-up LED  and Inverter Power Source LED  illuminates. Each unit's LCD shows the following screen and LEDs are on as follows.



6.2.5 Normal Mode Turn-off Procedures (Parallel)

- Press the **OFF** button  of one of the parallel UPSs for three to ten seconds and release it after you hear one beep. The LCD shows the message: **'SHUTDOWN UPS?'**. Select **'YES'** and press the function key below the symbol  to confirm your selection.

1. If the remaining parallel UPSs' total capacity exceeds the total critical loads, the inverter of the UPS that you turned off will automatically shut down, and the critical loads will be shared equally by the remaining parallel UPSs.

The status of the LCD and LEDs for the UPS that you turned off:

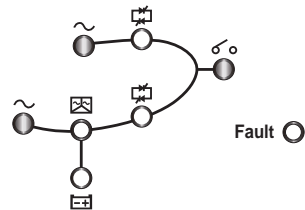
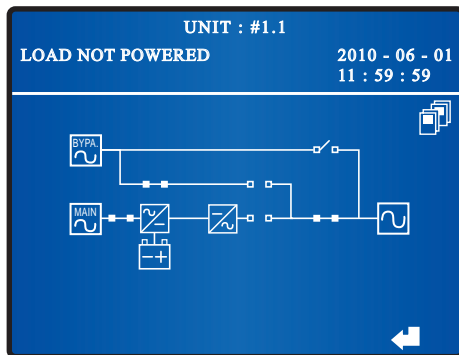

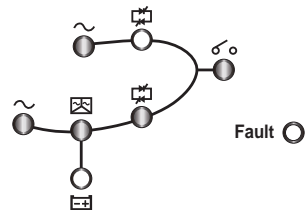
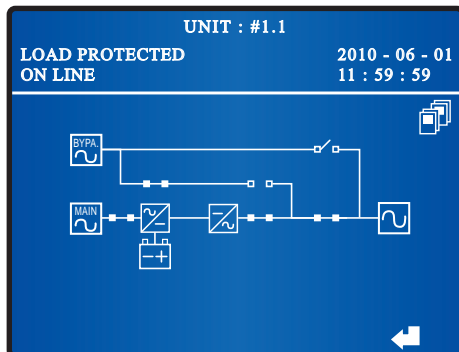

The status of the LCD and LEDs for the remaining parallel UPSs:

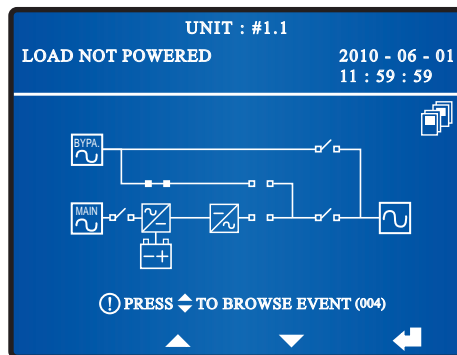

- 1 Turn off the Input Switch (Q1) and the Output Switch (Q4) of the UPS that you turned off, and the following screen appears.



- 2 Wait until the UPS's power module finishes discharging. During the discharging process, the Inverter Start-up LED  illuminates. After the power module finishes discharging, the Inverter Start-up LED  shuts off.
- 3 Switch off the Bypass Switch (Q2) of the UPS that you turned off and all of its connected external battery cabinets' circuit breakers or fuses. After that, all LEDs are off and no screen appears on the LCD.



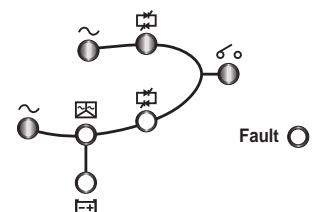
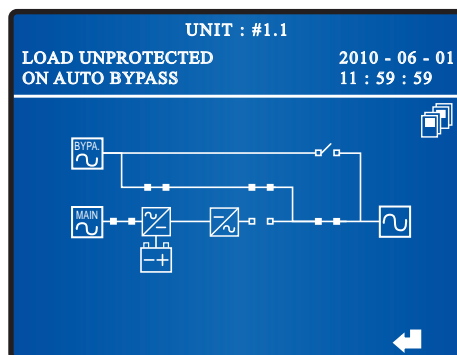

NOTE: If you need to turn off the remaining parallel UPSs, please repeat the procedures above.

2. If the total critical loads exceed the remaining parallel UPSs' total capacity, all parallel UPSs' inverters will shut down, inverter static switches will automatically turn off, and all parallel UPSs will transfer to bypass mode. The total critical loads will be shared equally by all parallel UPSs, and each of the parallel UPSs has the status of the LCD and LEDs as follows.



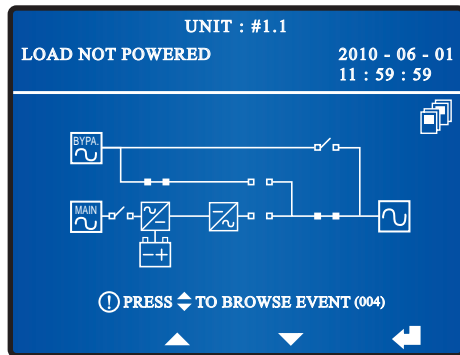

- 1 Since all parallel UPSs are in bypass mode, the critical loads won't be protected if a power failure occurs. Please confirm whether the critical loads should be shut down or not.
- 2 After confirmation, turn off all parallel UPSs' Input Switches (Q1), and the following screen appears on each of the parallel UPSs' LCDs.



- 3 Wait until all parallel UPSs' power modules finish discharging. During the discharging process, each UPS's Inverter Start-up LED  illuminates. After the power modules finish discharging, each UPS's Inverter Start-up LED  is off.
- 4 Switch off each UPS's Bypass Switch (Q2) and Output Switch (Q4) and all of the connected external battery cabinets' circuit breakers or fuses. After that, each unit's LCD and LEDs are off.

6.2.6 Battery Mode Turn-off Procedures (Parallel)

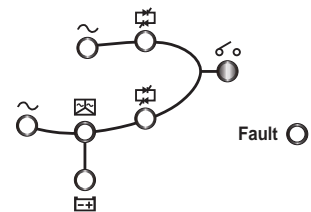
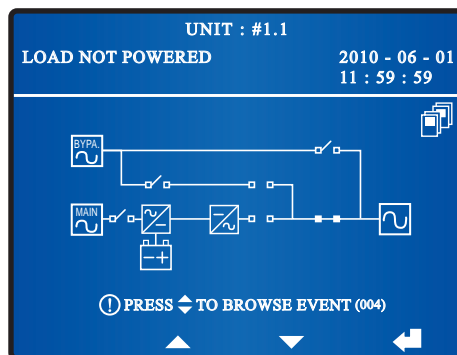

- Press the **OFF** button  of one of the parallel UPSs for three to ten seconds and release it after you hear one beep. The LCD shows the message: **'SHUTDOWN UPS?'**. Select **'YES'** and press the function key below the symbol  to confirm your selection.
1. If the remaining parallel UPSs' total capacity exceeds the total critical loads, the inverter of the UPS that you turned off will automatically shut down, and the critical loads will be equally shared by the remaining parallel UPSs.

The status of the LCD and LEDs for the UPS that you turned off:

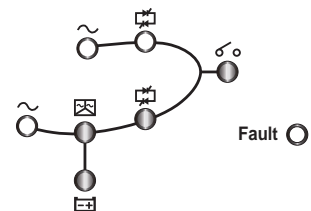
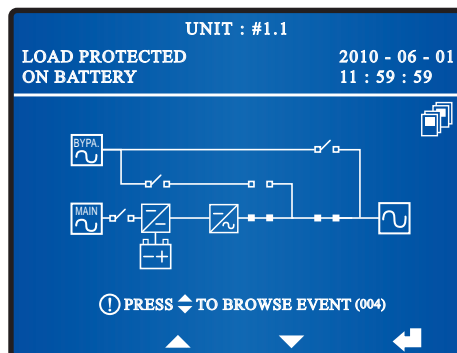

The status of the LCD and LEDs for the remaining parallel UPSs:



- ① Switch off the Output Switch (Q4) of the UPS that you turned off, and wait until the UPS's power module finishes discharging. During the discharging process, the Inverter Start-up LED  illuminates. After the power module finishes discharging, the Inverter Start-up LED  is off.

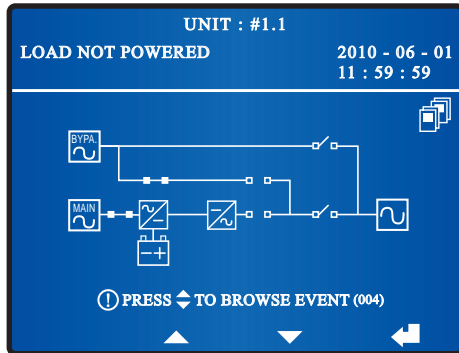



- ② Switch off the UPS's connected external battery cabinets' circuit breakers or fuses.



NOTE: If you need to turn off the remaining parallel UPSs, please repeat the procedures above.

2. If the total critical loads exceed the remaining parallel UPSs' total capacity, all parallel UPSs' inverters will shut down and inverter static switches will automatically turn off. At this moment, no power supplies to the critical loads.

- ① Wait until all parallel UPSs' power modules finish discharging. During the discharging process, each Inverter Start-up LED  illuminates. After the power modules finish discharging, each Inverter Start-up LED  is off.

- ② Turn off each unit's Output Switch (Q4) and each unit's connected external battery cabinets' circuit breakers or fuses.

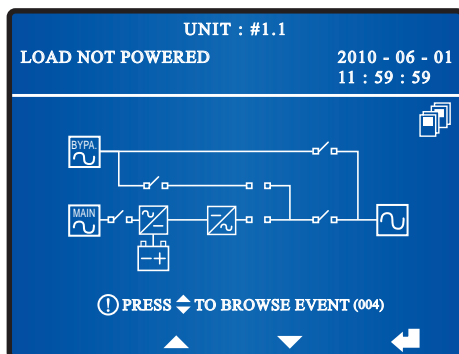

6.2.7 Bypass Mode Turn-off Procedures (Parallel)

- 1 During bypass mode, the status of the LCD and LEDs for each of the parallel UPSs are as follows.

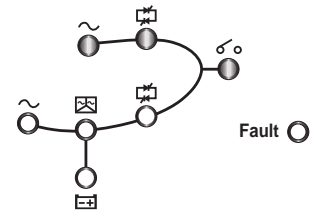
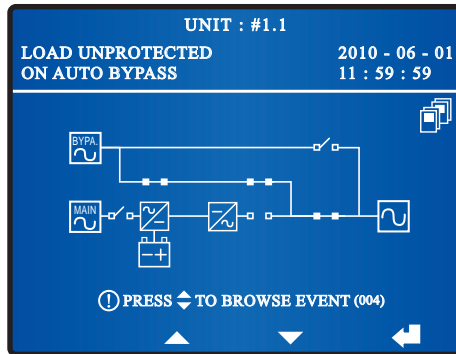

- 2 Turn off one of the parallel UPSs' Bypass Switch (Q2) and Output Switch (Q4), and the UPS's all LEDs and LCD are off. If you need to turn off the remaining parallel UPSs, please repeat the procedures above.

6.2.8 Manual Bypass Mode Turn-off Procedure (Parallel)

During manual bypass mode, no LED illuminates and no screen appears. Turn off each UPS's Manual Bypass Switch (Q3) to shut down the parallel UPSs.

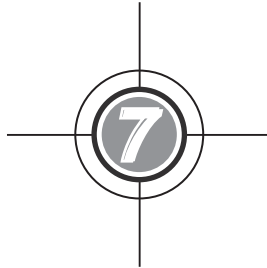

LCD Display & Settings

7.1 LCD Display Hierarchy

7.2 LCD Display & Function Keys

7.3 Password Entry

7.4 Main Screen

7.5 Main Menu

7.6 Check System Readings

7.7 UPS Configurations

7.8 System Maintenance

7.1 LCD Display Hierarchy

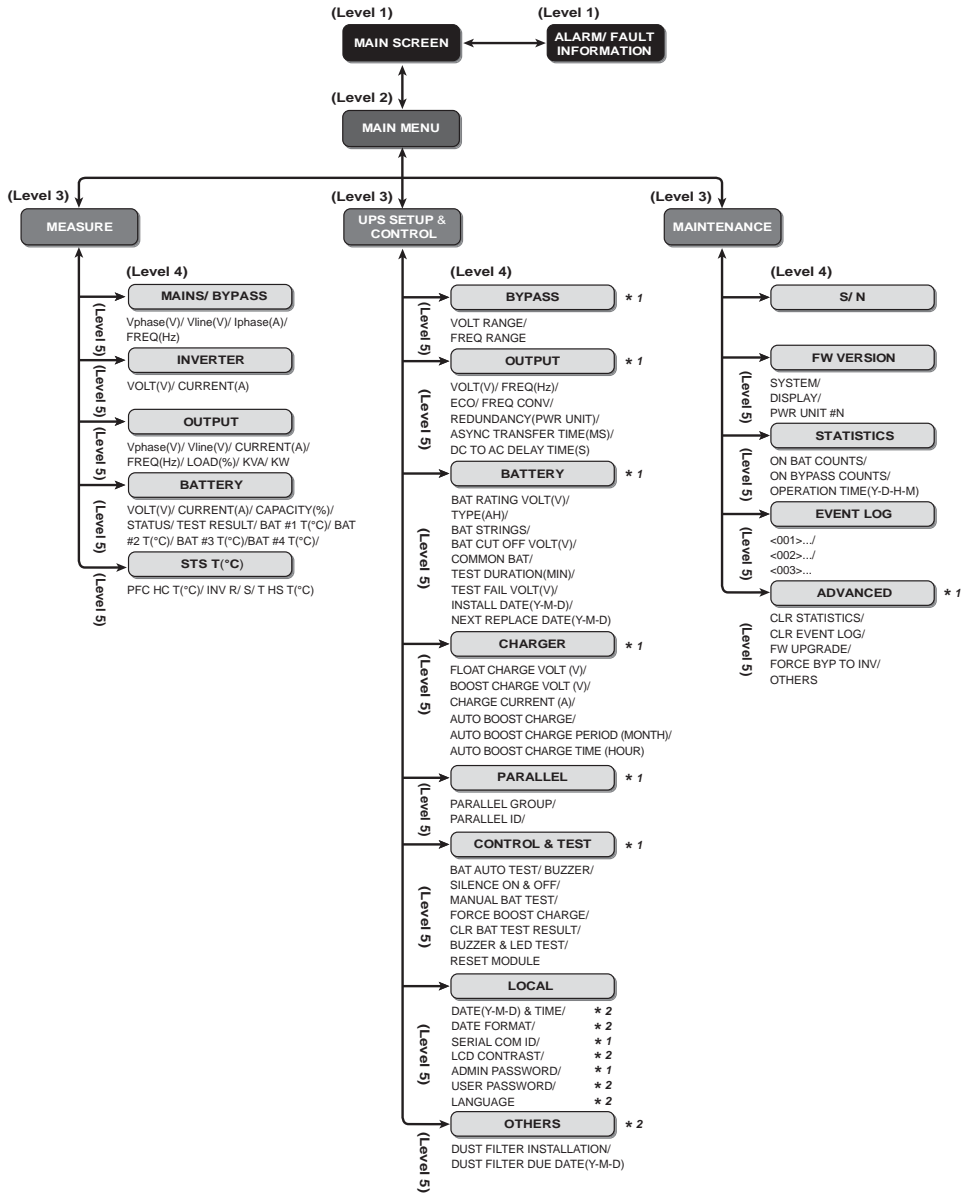

(Figure 7-1: LCD Display Hierarchy)



NOTE:

- *1 means that **ADMINISTRATOR** password is needed and *2 means that **USER** password is needed. For password information, please refer to **7.3 Password Entry**.
- All unit No., UPS status, date, time, and event No. (e.g. 004) shown in the LCD diagrams presented in **7. LCD Display and Settings** are for reference only. Actual readings depend on the operation of the UPS.

7.2 LCD Display & Function Keys

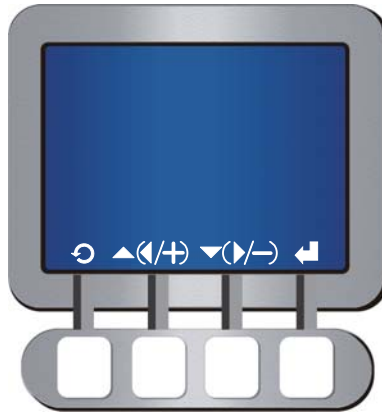

(Figure 7-2: LCD Display)

On the front of the UPS, there is an LCD display that lets you check the status of the UPS. There is no symbol on the function keys. The functions of keys depend on the symbols appearing on the LCD display. Please see the symbol table below.

| No. | Symbol | Function |
|-----|--------|--|
| 1 | ↻ | Goes back to previous screen or cancels current selection. |
| 2 | ▲ | Moves up. |
| 3 | ▼ | Moves down. |
| 4 | ◀ | Moves left. |
| 5 | ▶ | Moves right. |
| 6 | + | Increases number. |
| 7 | - | Decreases number. |
| 8 | ⏏ | Confirms selection or goes to Main Menu. |

As for other symbols shown on the LCD display, please see the following and refer to **1.5 Glossary of Symbols**.

| No. | Symbol | Function |
|-----|--------|--|
| 1 | ▶▶ | Cursor |
| 2 | ✎ | When the symbol ▶▶ changes to the symbol ✎, it means that you can change your selected item's setting. |
| 3 | ⓘ | Flashes when an alarm/ event occurs. |

If a screen is idle for 5 minutes, backlight shuts off. Press any function key to resume the backlight. In a **Main Screen**, press the function key below the symbol '⏏' to enter into **Main Menu** (please see **7.4 Main Screen** and **7.5 Main Menu**).

The language default setting is English. If you want to change the default setting, please go to **Main Menu** → **UPS SETUP & CONTROL** → **LOCAL** → **LANGUAGE** to change your setting.



NOTE: The language default setting may be different according to countries.

7.3 Password Entry

There are two levels of password protection:

- **ADMINISTRATOR** password allows qualified installation and maintenance personnel to view and change all settings.
- **USER** password only allows general users to set up (1) DATE & TIME, (2) DATE FORMAT, (3) LCD CONTRAST, (4) USER PASSWORD, (5) LANGUAGE, (6) DUST FILTER INSTALLATION and (7) DUST FILTER DUE DATE (Y-M-D).

The default setting for **USER** password is 0000. For **ADMINISTRATOR** password, please contact service personnel. When you try to change a setting, the following screen prompts you to enter a corresponding password.

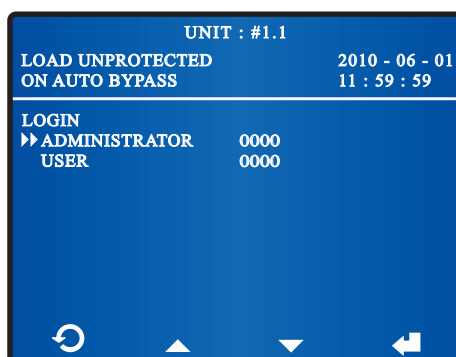

If an interval between settings is over five minutes, you have to login and enter the password again. If the password is wrong, the system will go back to the screen that you have selected the item for setup change.

7.4 Main Screen

When you turn on the Bypass Switch (Q2) and the Output Switch (Q4), the UPS starts up and the following screen appears. The system shows different screens depending on the status of the UPS. There are nine statuses, and each is called **Main Screen**.

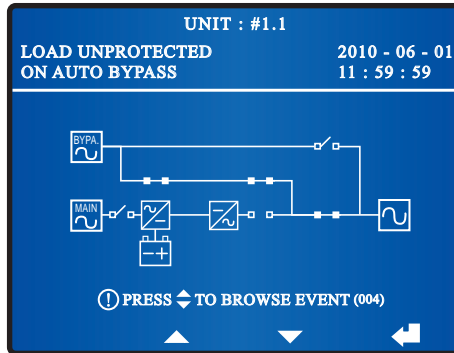

The nine statuses of the UPS shown in the LCD display are as follows.

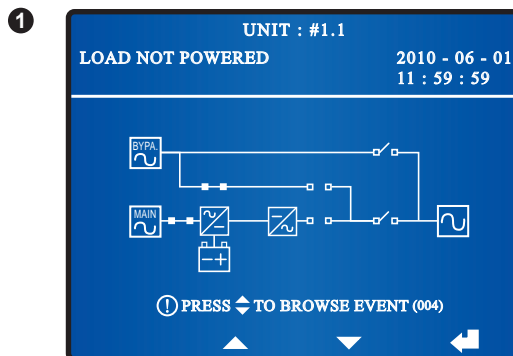

When the screen above appears, it means that no power is supplied to the critical loads connected.

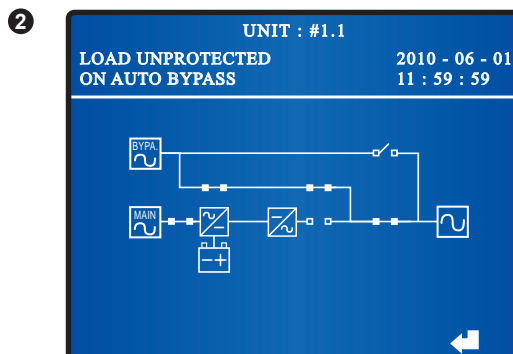

When the screen above appears, it means the bypass is supplying power to the critical loads.

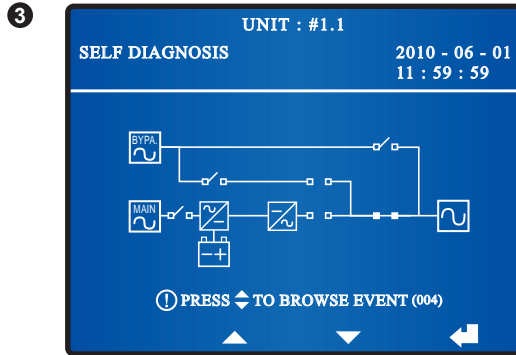

When the screen above appears, it means that batteries have started up the UPS.

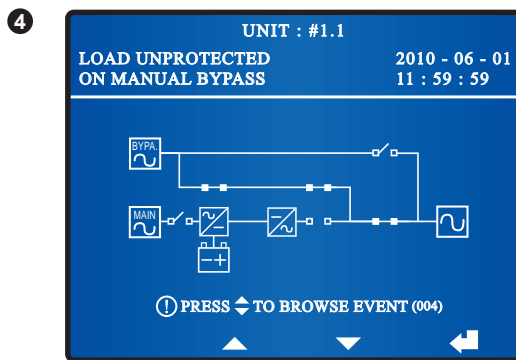

When the screen above appears, it means that the UPS is in bypass mode. If the bypass AC source fails, the critical loads won't be protected.

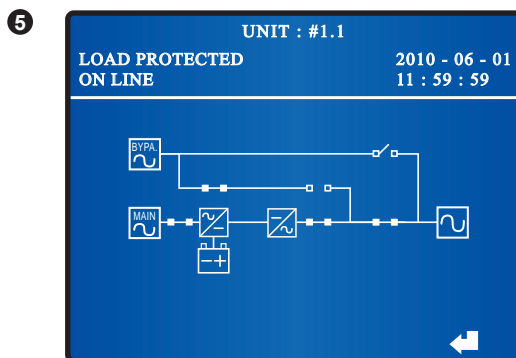

When the screen above appears, it means that the UPS is in normal mode.

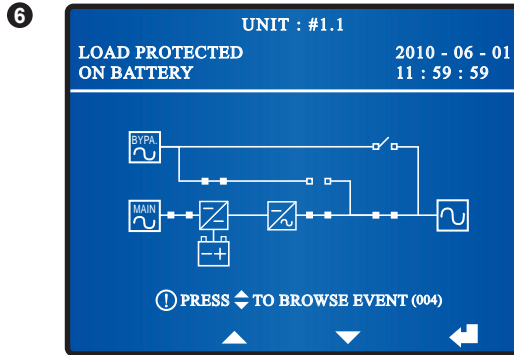

When the screen above appears, it means that the UPS is in battery mode.

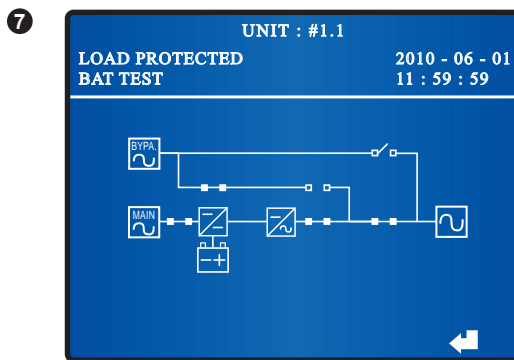

When the screen above appears, it means that the UPS is executing a battery test.

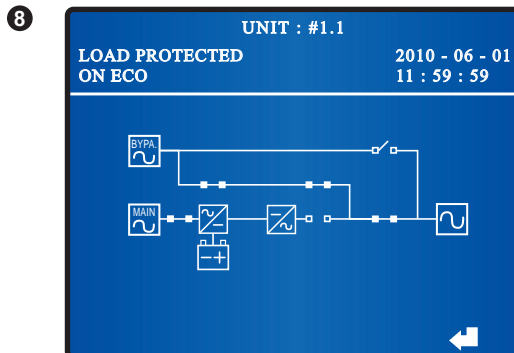

When the screen above appears, it means that the UPS is in ECO mode and the bypass supplies power to the critical loads. Please see **7.7.2 Output Setup** for ECO mode setup.



NOTE:

To ensure power supply quality, it is recommended that you set up the UPS in ECO mode only when the line power is stable. Only maintenance personnel can set up ECO mode.

9

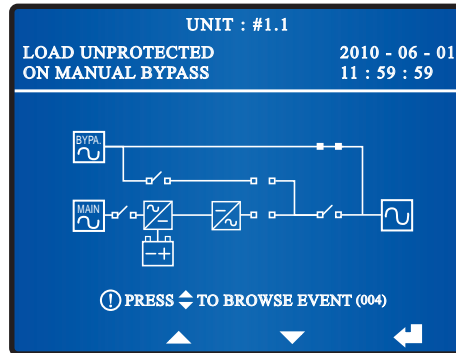

When the screen above appears, it means that the UPS is in manual bypass mode. Before maintenance, do not forget to switch the UPS into manual bypass mode and cut off the main AC source and batteries. During this mode, if the bypass AC source fails, the critical loads won't be protected.

7.5 Main Menu

In a **Main Screen**, press the function key below the symbol '←' to enter into the **Main Menu** shown below.

- **MEASURE**

Check the unit's mains, bypass, inverter, output, battery, and STS T(°C) readings.

- **UPS SETUP & CONTROL**

Configure UPS's setup including bypass, output, battery, charger, parallel, buzzer, LEDs, test and module reset.

- **MAINTENANCE**

Check/ clear the UPS's event log and statistics, check/ upgrade the UPS's firmware version, and check the UPS's power module information.

7.6 Check System Readings

Route: Main Screen → Main Menu → Measure

Use the function keys below the symbols '▲' and '▼' to check the unit's mains, bypass, inverter, output, battery, and STS T(°C) readings.

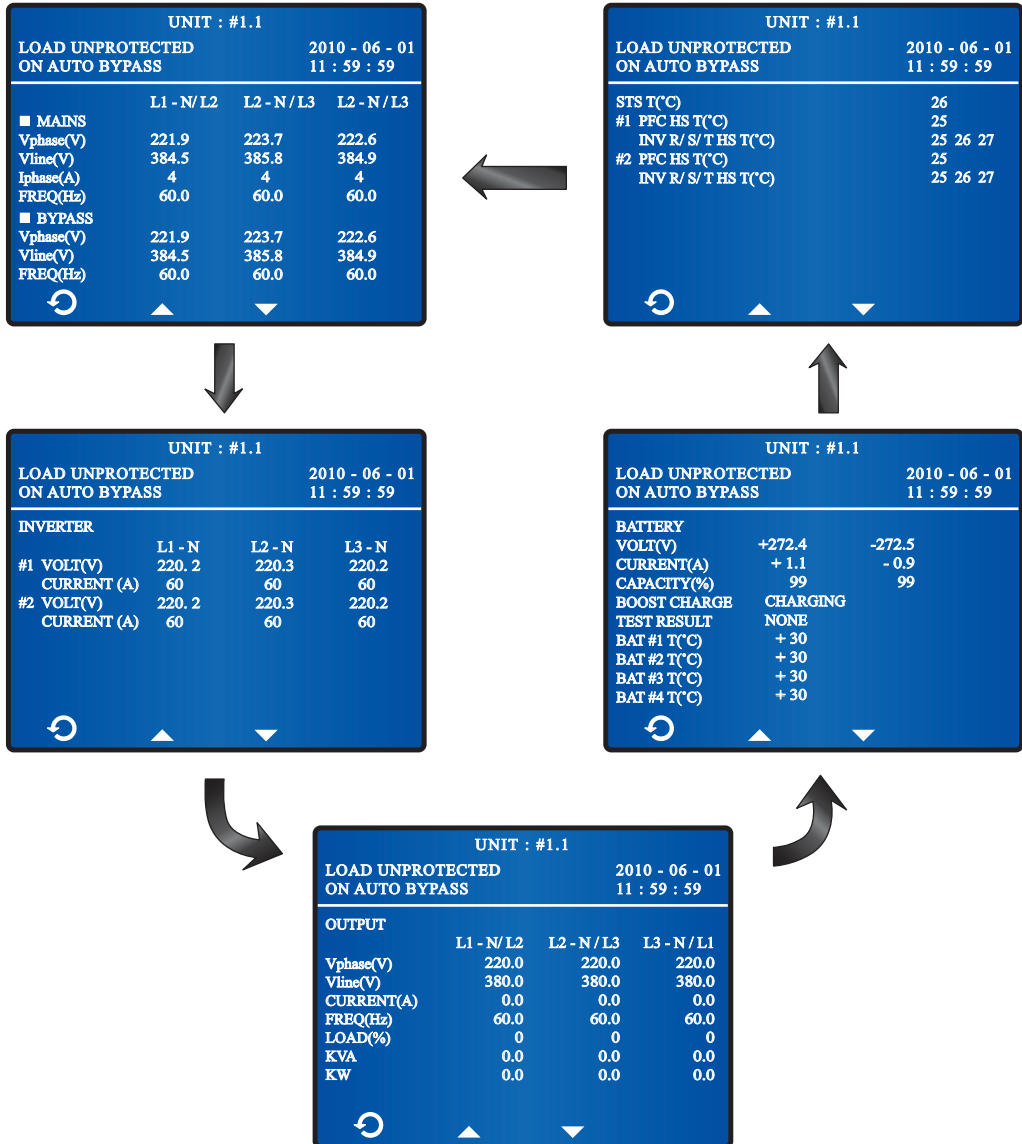

7.7 UPS Configurations

7.7.1 Bypass setup

Route: Main Screen → Main Menu → UPS Setup & Control → Bypass

In the **BYPASS SETUP** screen shown below, you can set up bypass mode's voltage range and frequency range. Out of the range, the system will disable the bypass function.

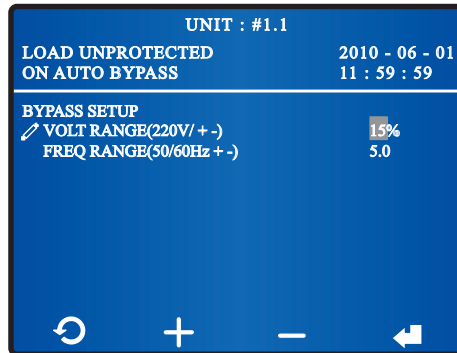

7.7.2 Output Setup

Route: Main Screen → Main Menu → UPS Setup & Control → Output

In the **OUTPUT SETUP** screen shown below, you can set up the following items.

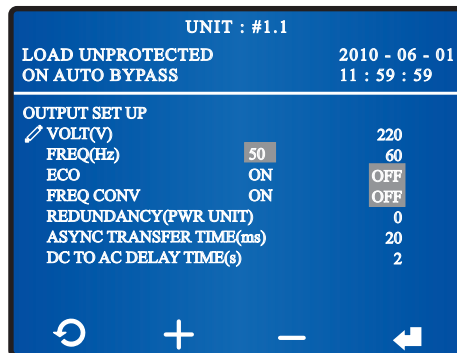

- **VOLT (V)**

Set up the output voltage.

- **FREQ (Hz)**

The system will automatically select the bypass source's output frequency.

- **ECO**

Set up the UPS in ECO mode. In ECO mode, it is the bypass to supply power to the critical loads. To ensure power supply quality, it is recommended that you set up the UPS in ECO mode only when the line power is stable. Only maintenance personnel can set up ECO mode.

- **FREQ CONV**

Enable or disable frequency converter mode. Only in bypass mode can you set up this item. After enabling the frequency converter mode, you can press the **ON** button  to start up the UPS.

- **REDUNDANCY (PWR UNIT)**

Set up how many power units that you want to reserve for redundancy.

- **ASYNC TRANSFER TIME (ms)**

Based on the connected loads to set up the asynchronous transfer time (for normal mode to bypass mode only).

- **DC TO AC DELAY TIME (s)**

Set up the DC to AC delay time.

7.7.3 Battery Setup

Route: Main Screen → Main Menu → UPS Setup & Control → Battery

After entering the **BATTERY SETUP** screen shown below, you can set up the following items.

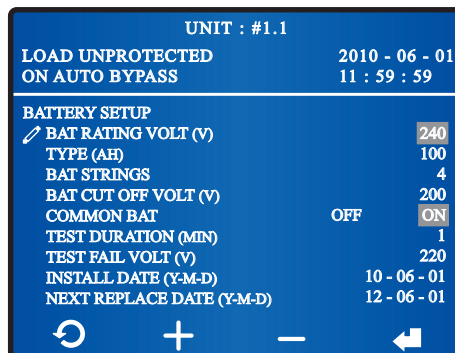

- **BAT RATING VOLT (V)**

Set up battery voltage.

- **TYPE (AH)**

Set up battery type.

- **BAT STRINGS**

Set up how many battery strings are used.

- **BAT CUT OFF VOLT (V)**

Set up battery low voltage. In battery mode, when the battery low voltage is reached, the battery power will cut off, the UPS will shut down, and the connected loads won't be protected.

- **COMMON BAT**

Set up whether batteries need to be shared in parallel mode.

- **TEST DURATION (MIN)**

Set up how long the battery test should last.

- **TEST FAIL VOLT (V)**

Set up test fail voltage. When the battery voltage is under the test fail voltage, it means battery fail.

- **INSTALL DATE (Y-M-D)**

Set up battery installation date.

- **NEXT REPLACE DATE (Y-M-D)**

Set up battery replacement date.

7.7.4 Charger Setup

Route: Main Screen → Main Menu → UPS Setup & Control → Charger Setup

In the **CHARGER SETUP** screen shown below, you can set up float charge voltage, boost charge voltage, and charge current.

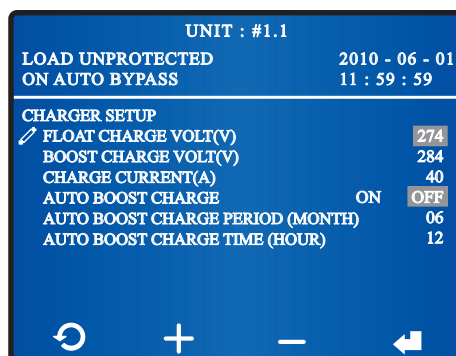

- **FLOAT CHARGE VOLT (V)**
Set up float charge voltage.
- **BOOST CHARGE VOLT (V)**
Set up boost charge voltage.
- **CHARGE CURRENT (A)**
Set up charge current.
- **AUTO BOOST CHARGE**
Set up 'AUTO BOOST CHARGE' as ON or OFF.
- **AUTO BOOST CHARGE PERIOD (MONTH)**
Set up auto boost charge period (month).
- **AUTO BOOST CHARGE TIME (HOUR)**
Set up auto boost charge time (hour).

7.7.5 Parallel Setup

Route: Main Screen → Main Menu → UPS Setup & Control → Parallel Setup

If you parallel UPSs, please go to **PARALLEL SETUP** screen shown below to set up a parallel group ID No. and a parallel ID No. for each parallel UPS.

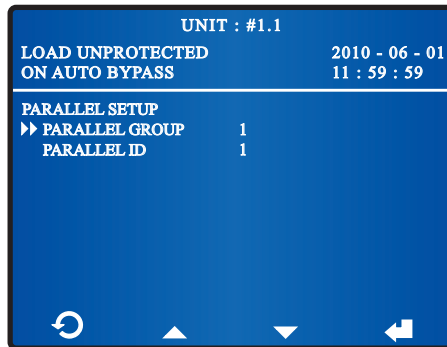

- **PARALLEL GROUP**

Set up a parallel group ID No. (1~2) for each parallel UPS.

If all parallel UPSs connect to the same group of critical loads, set each parallel UPS's parallel group ID No. as 1.

If parallel UPSs connect to different groups of critical loads (maximum group: two), set each UPS's parallel group ID No. as 1 or 2 accordingly.

- **PARALLEL ID**

Set up a parallel ID No. (1~8) for each parallel UPS. You can parallel at maximum eight UPS units.

7.7.6 Test, Buzzer and LED Setup, and Module Reset

Route: Main Screen → Main Menu → UPS Setup & Control → Control & Test

In the **CONTROL & TEST** screen shown below, you can execute some tests, enable/disable buzzer, clear battery test result, and reset module.

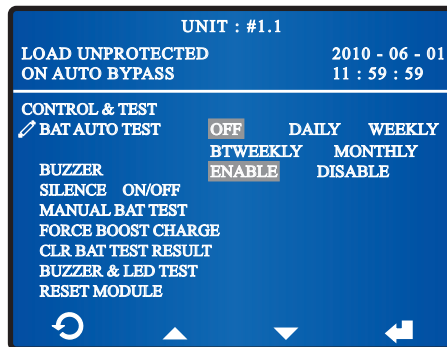

- **BAT AUTO TEST**

Enable or disable battery auto test. If you wish to enable the battery auto test, please select an auto test frequency.

- **BUZZER**

Enable/ disable buzzer.

- **SILENCE ON/OFF**

Silence the buzzer. Please note that the UPS will trigger the buzzer again if the same abnormality re-occurs.

- **MANUAL BAT TEST**

Manually force the unit to perform a battery test. However, if the icon  appears on the Main Screen, a battery test won't be executed even you have set up to active the manual battery test. For the meaning of the icon, please refer to **1.5 Glossary of Symbols**.

- **FORCE BOOST CHARGE**

Manually force the unit to execute boost charge to charge the batteries.

- **CLR BAT TEST RESULT**

Clear battery test result.

- **BUZZER & LED TEST**

Perform buzzer and LED test.

- **RESET MODULE**

In bypass mode, if you press the **ON** button  to start up the UPS and there is no response, please use the LCD to reset module. After the module is reset, you can press the **ON** button  to start up the UPS.



NOTE: After entering each of the following selections, **SILENCE ON/OFF**, **MANUAL BAT TEST**, **FORCE BOOST CHARGE**, **CLR BAT TEST RESULT**, **BUZZER & LED TEST** and **RESET MODULE**, use the function keys below the symbols '◀' and '▶' to select 'YES' or 'NO', and then press the function key below the symbol '◀' to complete your setup.

7.7.7 Local Setup

Route: Main Screen → Main Menu → UPS Setup & Control → Local

In the **LOCAL** screen shown below, you can set up the items as follows.

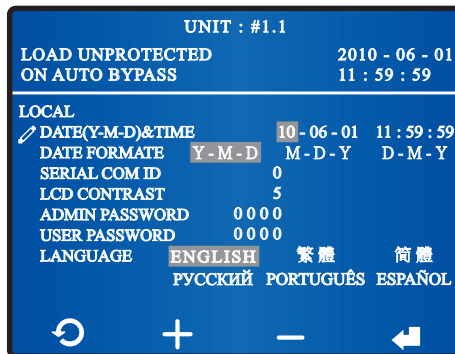

- **DATE (Y-M-D) & TIME**

Set up date and time.

- **DATE FORMAT**

Select a date format you like.

- **SERIAL COM ID**

For standard RS-232 connection, this ID is meaningless. If you use other brand's RS-485/ RS-422 converter to connect to the UPS's RS-232 port, this ID should be set (0~99). Please consult qualified service personnel.

- **LCD CONTRAST**

Adjust the LCD display contrast. The default setting is 5.

- **ADMIN PASSWORD**

Change administrator password (four digits).

- **USER PASSWORD**

Change user password (four digits).

- **LANGUAGE**

Change display language. The default setting is ENGLISH.

7.7.8 Dust Filter Setup

Route: Main Screen → Main Menu → UPS Setup & Control → Others

In the **OTHERS SETUP** screen shown below, you can set up dust filter installation date and dust filter due date.

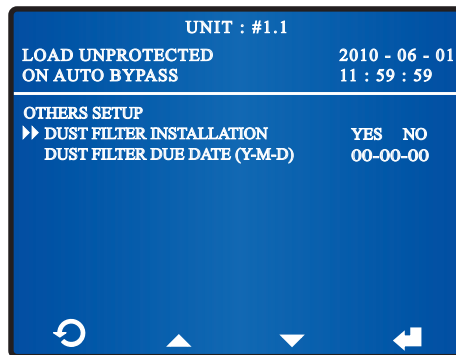

- **DUST FILTER INSTALLATION**

Select 'YES' if you have installed dust filters.

- **DUST FILTER DUE DATE (Y-M-D)**

Set up a replacement/ clean date for the dust filters. When the date is due, the LCD will automatically show '**PLS CLEAN/ REPLACE DUST FILTERS**' message.

7.8 System Maintenance

7.8.1 Check/ Clear Event Log

- * To check event log, go to:

Main Screen → Main Menu → Maintenance → Event Log

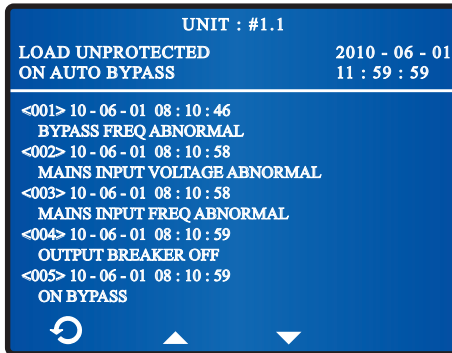

The screen above provides event No., event date, time, and event descriptions. Use the function keys below the symbols '▲' and '▼' to view other events.

The greater the event number, the newer the event. The event code is shown in the < >.

Old events will be overwritten when the total number of events exceeds storage capacity (up to 500 entries can be saved).

- * To check event log, go to:

Main Screen → Main Menu → Maintenance → Advanced → Clr Event Log

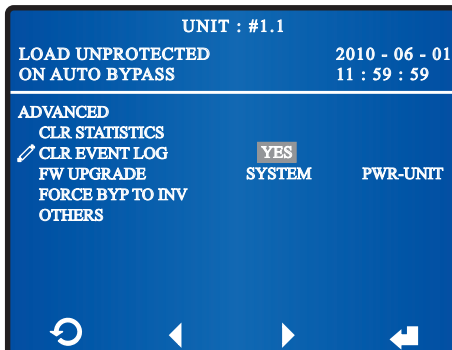

Use the function keys below the symbols '◀' and '▶' to select 'YES' or 'NO'. Once you select 'YES' and press the function key below the symbol '◀', all events in the log will be cleared. The administrator password is required.



NOTE:

The event log provides important information for system analysis and maintenance. Do not clear the event log without the consent of qualified service personnel.

7.8.2 Check/ Clear Statistics

* To check statistics, go to:

Main Screen → Main Menu → Maintenance → Statistics

| UNIT : #1.1 | |
|-----------------------|----------------|
| LOAD UNPROTECTED | 2010 - 06 - 01 |
| ON AUTO BYPASS | 11 : 59 : 59 |
| STATISTICS | |
| ON BAT COUNTS | 11 |
| ON BYPASS COUNTS | 121 |
| OPERATION TIME(Y-D-H) | 00 / 231 / 22 |



- **ON BAT COUNTS**

It means how many times the UPS runs in battery mode.

- **ON BYPASS COUNTS**

It means how many times the UPS runs in bypass mode.

- **OPERATION TIME (Y-D-H)**

Total operation time.

* To clear statistics, go to:

Main Screen → Main Menu → Maintenance → Advanced →Clr Statistics

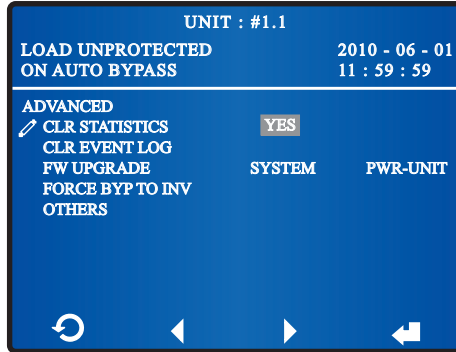

Use the function keys below the symbols '◀' and '▶' to select 'YES' or 'NO'. Once you select 'YES' and press the function key below the symbol '◀', all statistics will be cleared. The administrator password is required.



NOTE:

The statistics provide important information for system analysis and maintenance. Do not clear the statistics without the consent of qualified service personnel.

7.8.3 Check/ Upgrade Firmware

- * To check firmware version, go to:

Main Screen → Main Menu → Maintenance → FW Version

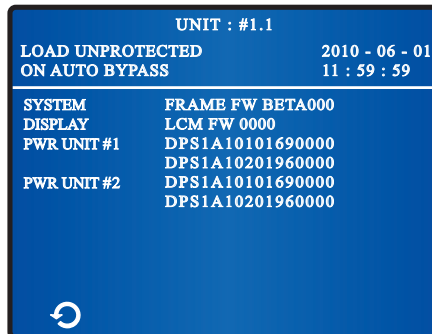

The firmware version screen above shows you the system, display and power unit's firmware versions.

* To upgrade firmware version, go to:

Main Screen → Main Menu → Maintenance → Advanced → FW Upgrade

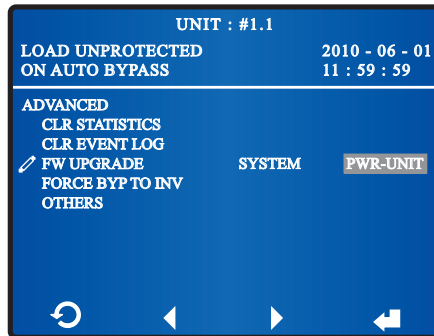

If you select 'SYSTEM', the UPS will upgrade system's firmware. If you choose 'PWR-UNIT', the UPS will upgrade power unit's firmware. After you select 'PWR-UNIT', the following screens appear in order.

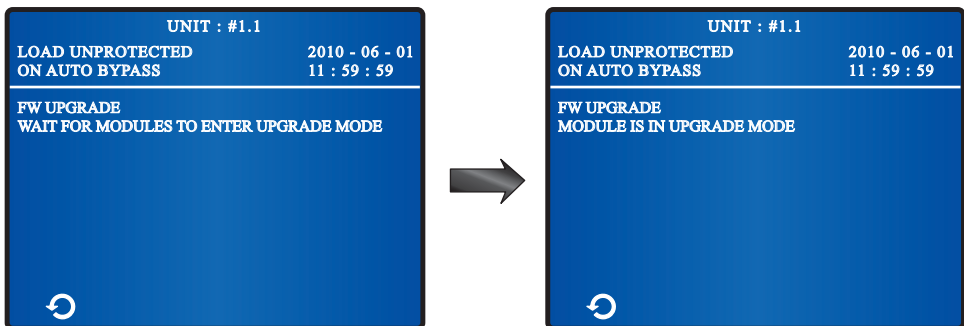

7.8.4 Force Bypass to Inverter

* If the UPS runs in bypass mode and you wish to transfer bypass mode into inverter mode, please go to:

Main Screen → Main Menu → Maintenance → Advanced → Force BYP to INV

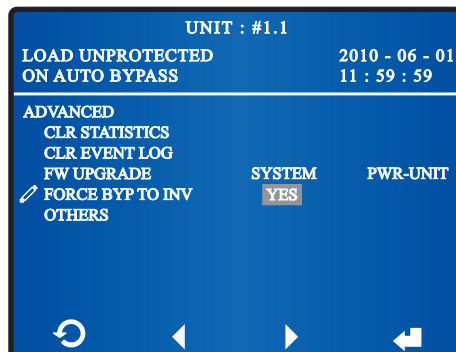

Use the function keys below the symbols '◀' and '▶' to select 'YES' or 'NO'. Once you select 'YES' and press the function key below the symbol '◀', the system will transfer from bypass mode into inverter mode. The administrator password is required.

7.8.5 Others

- * If you want to know the UPS's PWR UNIT #n PFC status, DC bus voltage, static switch status, charge voltage and charge current, please go to:

Main Screen → Main Menu → Maintenance → Advanced → Others

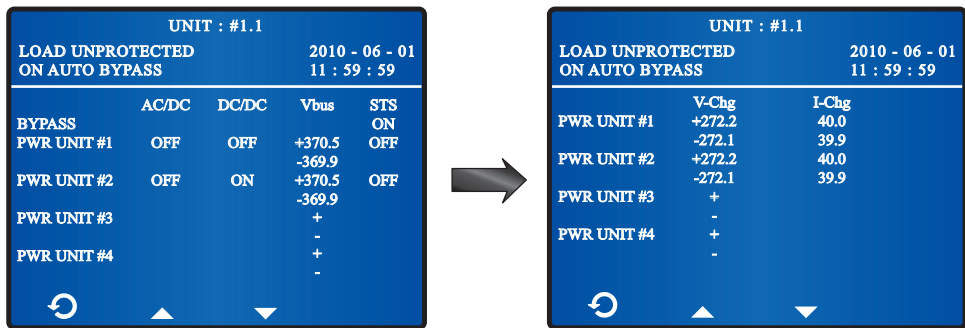

AC/DC & DC/DC, Vbus, STS, V-Chg, and I-Chg mean PWR UNIT #n PFC status, DC bus voltage, static switch status, charge voltage and charge current respectively.

- * If you want to know the UPS's serial No., please go to:

Main Screen → Main Menu → Maintenance → S/N

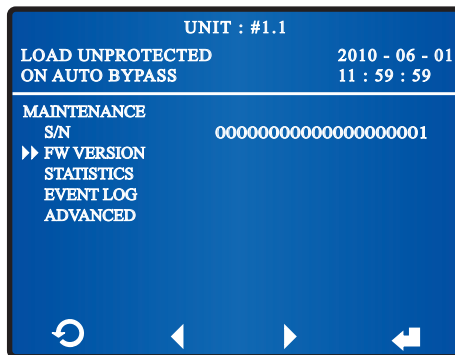

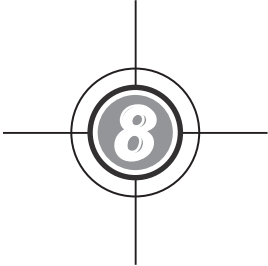

Optional Accessories

There are several optional accessories available for this DPS series UPS. Please refer to the table below for the optional accessories and their descriptions.

| No. | Item | Function |
|-----|--|---|
| 1 | Dust Filter | Prevents dust from entering into the UPS to ensure UPS reliability and to prolong product life. |
| 2 | SNMP Card (IPv4 or IPv6) | Monitors the status of the UPS via internet. |
| 3 | Relay I/O Card | Increases the quantity of dry contacts. |
| 4 | MODBUS Card | Lets the UPS have MODBUS communication function. |
| 5 | Battery Cabinet Temperature Sensor Cable | Detects the temperature of an external battery cabinet connected to the UPS. |



REFERENCE:

1. For detailed installation and operation of any accessory mentioned above, please refer to the **Quick Guide, User Guide, or Installation & Operation Guide** included in the package of the relevant optional accessory.
2. If you want to buy any accessory mentioned above, please contact your local dealer or customer service.



Maintenance

- **UPS**

1. UPS Cleaning:

Regularly clean the UPS, especially the slits and openings, to ensure that the air freely flows into the UPS to avoid overheating. If necessary, use an air-gun to clean the slits and openings to prevent any object from blocking or covering these areas.

2. UPS Regular Inspection:

Regularly check the UPS every half year and inspect:

- 1) Whether the UPS, LEDs, and alarm function are operating normally.
- 2) Whether the UPS works in bypass mode (normally, the UPS will work in normal mode). If yes, check if any error, overload, internal fault, etc. occurs.
- 3) Whether battery voltage is normal. If the battery voltage is too high or too low, find the root cause.

- **Battery**

The DPS series UPS uses sealed lead-acid batteries. The battery life depends on the temperature, the usage, and the charging/ discharging frequency. High temperature environments and high charging/ discharging frequency will quickly shorten the battery life. Please follow the suggestions below to ensure a normal battery lifetime.

1. Keep usage temperature between 15°C ~ 25°C (59°F ~ 77°F).
2. When the UPS needs to be stored for an extended period of time, the batteries must be recharged once every three months and the charging time must not be less than 24 hours each time.

- **Fan**

Higher temperatures shorten fan life. When the UPS is running, please check if all fans on the top of the UPS and two fans used to cool the charger work normally and make sure if the ventilation air can move freely around and through the UPS. If not, replace the fans.



NOTE:

Please ask your local dealer or customer service for more maintenance information. Do not perform maintenance if you are not trained for it.



Troubleshooting

When you see the following alarm messages appear on the LCD, please follow the solutions shown below.

| No. | Alarm Message | Possible Cause | Solution |
|-----|--|--|--|
| 1 | MAINS INPUT VOLT OR FREQ NOK | <ol style="list-style-type: none"> The Input Switch (Q1) is turned off. The main AC source's voltage or frequency is abnormal. | <ol style="list-style-type: none"> Check whether the Input Switch (Q1) is turned off. If yes, turn it on. If the Input Switch (Q1) is turned on but the alarm still exists, contact service personnel. Check if the main AC source's voltage or frequency is abnormal. If yes, please wait until the main AC source becomes normal. |
| 2 | MAINS INPUT PHASE SEQ NOK | Wrong wiring. | Check if the main AC source's wiring and phase sequence are correct. If not, please contact service personnel. |
| 3 | PWR UNIT #n PFC FUSE OPEN SHUTDOWN | PFC fuse is fused. | Contact service personnel. |
| 4 | PWR UNIT #n INV FUSE OPEN SHUTDOWN | Inverter fuse is fused. | Contact service personnel. |
| 5 | PWR UNIT #n GENERAL FAULT | Power unit's control circuit has abnormalities, e.g. abnormal auxiliary power, failing soft start, etc. | Contact service personnel. |
| 6 | SYSTEM GENERAL FAULT | System's auxiliary power is abnormal. | Contact service personnel. |
| 7 | BAT CABINET OVER HEAT | <ol style="list-style-type: none"> Battery cabinet's temperature is too high. Battery cabinet has abnormalities. | <ol style="list-style-type: none"> Decrease the battery cabinet's temperature. Check if the battery cabinet has any abnormality. If yes, contact service personnel. |
| 8 | BAT TEST FAIL | <ol style="list-style-type: none"> Wrong battery wiring. Battery abnormality. | <ol style="list-style-type: none"> Check if battery grounding is correct or not. If not, contact service personnel. Check if battery has abnormalities. If yes, contact service personnel to replace battery. |

| No. | Alarm Message | Possible Cause | Solution |
|-----|------------------------------------|--|--|
| 9 | BAT LOW WARNING | Battery voltage is lower than warning limit. | If there is no backup power, immediately shut down the critical loads connected to the UPS. |
| 10 | LOW BAT CUT OFF | Battery voltage is lower than shutdown limit. | If there is no backup power, the UPS will automatically discontinue power supply to the critical loads to protect battery until battery power recovers. |
| 11 | BAT REPLACE REQUIRED | <ol style="list-style-type: none"> 1. System date is wrongly set. 2. Battery replacement date is due. | <ol style="list-style-type: none"> 1. Check if system date is set correctly. If not, correct it. 2. Check if battery replacement date is due. If yes, contact service personnel to replace battery(ies). |
| 12 | PWR UNIT #n CHARGER FAIL | Charger temperature is too high. | Contact service personnel. |
| 13 | BAT OVER CHARGE | Charger is abnormal. | Contact service personnel. |
| 14 | BAT MISSING | <ol style="list-style-type: none"> 1. Wrong battery wiring. 2. Insufficient battery voltage. | <ol style="list-style-type: none"> 1. Check if battery wiring is correct or not. If not, contact service personnel. 2. Check if battery voltage is abnormal or not. If yes, contact service personnel. |
| 15 | PWR UNIT #n PFC OVER HEAT WARNING | <ol style="list-style-type: none"> 1. Fans have abnormalities. 2. Foreign matter is stuck in the fans. | Check if fans work abnormally or foreign matter is blocking a fan. If yes, contact service personnel. If not, please decrease some critical loads. |
| 16 | PWR UNIT #n PFC OVER HEAT SHUTDOWN | <ol style="list-style-type: none"> 1. Fans have abnormalities. 2. Foreign matter is stuck in the fans. | Check if fans work abnormally or foreign matter is blocking a fan. If yes, contact service personnel. If not, please decrease some critical loads. |
| 17 | PWR UNIT #n INV OVER HEAT WARNING | <ol style="list-style-type: none"> 1. Fans have abnormalities. 2. Foreign matter is stuck in the fans. | Check if fans work abnormally or foreign matter is blocking a fan. If yes, contact service personnel. If not, please decrease some critical loads. |

| No. | Alarm Message | Possible Cause | Solution |
|-----|--|---|--|
| 18 | PWR UNIT #n INV OVER HEAT SHUTDOWN | <ol style="list-style-type: none"> 1. Fans have abnormalities. 2. Foreign matter is stuck in the fans. | Check if fans work abnormally or foreign matter is blocking a fan. If yes, contact service personnel. If not, please decrease some critical loads. |
| 19 | PFC SCR FAULT | <ol style="list-style-type: none"> 1. PFC SCR is damaged. 2. Driving circuit is damaged. | Contact service personnel. |
| 20 | PWR UNIT #n DC BUS NOK | DC BUS voltage is too high or too low. | Contact service personnel. |
| 21 | PWR UNIT #n INV OUTPUT NOK SHUTDOWN | Inverter's output voltage is too high or too low. | Contact service personnel. |
| 22 | UPS OUTPUT FAULT SHUTDOWN | Inverter's output voltage is too high or too low. | Contact service personnel. |
| 23 | INV OVER CURRENT | Output might have shorting issues. | Contact service personnel. |
| 24 | PWR UNIT #n INV SHORT CIRCUIT SHUTDOWN | Output might have shorting issues. | Contact service personnel. |
| 25 | PWR UNIT #n INV STS FAIL SHUTDOWN | <ol style="list-style-type: none"> 1. Inverter's static switch is damaged. 2. Inverter's driving circuit is damaged. | Contact service personnel. |
| 26 | BYPASS STS OVER HEAT | <ol style="list-style-type: none"> 1. Fans have abnormalities. 2. Foreign matter is stuck in the fans. 3. The UPS is overloaded. | Check if fans work abnormally or foreign matter is blocking a fan. If yes, contact service personnel. If not, please decrease critical loads. |
| 27 | BYPASS INPUT VOLT OR FREQ NOK | <ol style="list-style-type: none"> 1. The Bypass Switch (Q2) is turned off. 2. Bypass voltage or frequency is abnormal. | <ol style="list-style-type: none"> 1. Check if the Bypass Switch (Q2) is turned off. If yes, turn it on. 2. If the Bypass Switch (Q2) is turned on but the alarm still exists, contact service personnel. 3. Check if bypass voltage or frequency is abnormal. If yes, please wait until bypass AC source becomes normal. |

| No. | Alarm Message | Possible Cause | Solution |
|-----|--------------------------------|---|--|
| 28 | BYPASS INPUT PHASE SEQ NOK | Wrong wiring. | Check if the bypass AC source's wiring and phase sequence are correct. If not, contact service personnel. |
| 29 | BYPASS STS OVER CURRENT | The UPS is overloaded. | Decrease some critical loads. |
| 30 | BYPASS STS FAIL | <ol style="list-style-type: none"> 1. Bypass static switch is damaged. 2. Bypass driving circuit is damaged. | Contact service personnel. |
| 31 | EMERGENCY POWER OFF | Emergent shutdown is executed. | Shut down the UPS. After emergency events are eliminated, follow turn-on procedures to start up the UPS. |
| 32 | PWR UNIT #n COMMUNICATION NOK | <ol style="list-style-type: none"> 1. Internal communication cable is not firmly connected. 2. Communication circuit is abnormal. | Contact service personnel. |
| 33 | EXT PARALLEL COMMUNICATION NOK | Parallel cable is not firmly connected. | Check if parallel cable is firmly connected or not. If not, connect it firmly. |
| 34 | PARALLEL FAIL | <ol style="list-style-type: none"> 1. Parallel UPSs are not compatible. 2. There are conflicts between parallel UPSs' IDs. | <ol style="list-style-type: none"> 1. Check if there are conflicts between parallel UPSs' IDs. If yes, contact service personnel. 2. Check if parallel UPSs are compatible or not. If not, contact service personnel. |
| 35 | ON MANUAL BYPASS | The Manual Bypass Switch (Q3) is turned on. | <ol style="list-style-type: none"> 1. Check if the Manual Bypass Switch (Q3) is turned on. If yes, turn it off. 2. If the Manual Bypass Switch (Q3) is turned off and the alarm still exists, contact service personnel. |
| 36 | REDUNDANCY LOSS | Overload causes redundancy failure. | Decrease critical loads and reset redundancy. |

| No. | Alarm Message | Possible Cause | Solution |
|-----|------------------------------|---|--|
| 37 | INPUT TRANSFORMER OVER HEAT | <ol style="list-style-type: none"> 1. Fans have abnormalities. 2. Foreign matter is stuck in the fans. 3. The UPS is overloaded. | Check if fans work abnormally or foreign matter is blocking a fan. If yes, contact service personnel. If not, decrease critical loads. |
| 38 | OUTPUT TRANSFORMER OVER HEAT | <ol style="list-style-type: none"> 1. Fans have abnormalities. 2. Foreign matter is stuck in the fans. 3. The UPS is overloaded. | Check if fans work abnormally or foreign matter is blocking a fan. If yes, contact service personnel. If not, please decrease critical loads. |
| 39 | LCM COMMUNICATION LOSS | <ol style="list-style-type: none"> 1. LCM communication cable is not firmly connected. 2. LCM communication circuit is abnormal. | <ol style="list-style-type: none"> 1. Check if the LCM communication cable is firmly connected. If not, connect it firmly. 2. If the LCM communication cable is firmly connected but the alarm still exists, the LCM communication circuit might have abnormalities. Please contact service personnel. |
| 40 | PWR UNIT #n NOT CALIBRATED | EEPROM is damaged. | Contact service personnel. |
| 41 | SYSTEM COMMUNICATION NOK | System's communication circuit is abnormal. | Contact service personnel. |
| 42 | OUTPUT OVERLOAD WARNING | The UPS is overloaded. | Decrease critical loads. |
| 43 | OUTPUT OVERLOAD SHUTDOWN | The UPS is overloaded. | Decrease critical loads. |
| 44 | PWR UNIT #n ABNORMAL CHANGE | Power unit's control circuit is abnormal. | Contact service personnel. |
| 45 | OUTPUT BREAKER OFF | The Output Switch (Q4) is turned off. | <ol style="list-style-type: none"> 1. Check if the Output Switch (Q4) is turned off. If yes, turn it on. 2. If the Output Switch (Q4) is turned on but the alarm still exists, contact service personnel. |

| No. | Alarm Message | Possible Cause | Solution |
|-----|-------------------------------------|--|---|
| 46 | BATTERY BREAKER OFF | Battery circuit breaker is turned off. | <ol style="list-style-type: none"> 1. Check if the battery circuit breaker is turned off. If yes, turn it on. 2. If the battery circuit breaker is turned on but the alarm still exists, contact service personnel. |
| 47 | EXT PARALLEL UNCOMPATIBLE | The firmware versions between parallel UPSs are not compatible. | Contact service personnel. |
| 48 | FRAME OVER AUTO RECOVER LIMIT | System's repeated auto protection frequency is over limit. | Contact service personnel. |
| 49 | PWR UNIT #n OVER AUTO RECOVER LIMIT | Power unit's repeated auto protection frequency is over limit. | Contact service personnel. |
| 50 | OUT OF ECO RANGE | Bypass voltage or frequency is out of ECO mode limit. | Check the bypass voltage and frequency. If abnormal, contact service personnel. |
| 51 | FAN MODULE FAIL | <ol style="list-style-type: none"> 1. System fans or module fans are abnormal. 2. Foreign matter is stuck in the fans. | <ol style="list-style-type: none"> 1. Check if the fans have abnormalities. If yes, contact service personnel. 2. If foreign matter is blocking a fan, remove it. After removing the foreign matter, double check whether all fans can run normally. If not, contact service personnel. |
| 52 | DUST FILTER REPLACEMENT REQUIRED | <ol style="list-style-type: none"> 1. System date is wrongly set. 2. Dust filter replacement/ clean date is due. | <ol style="list-style-type: none"> 1. Check if the system date is set correctly. 2. Replace/ clean the dust filters and reset the replacement/ clean date. |
| 53 | MAINS INPUT BREAKER OFF | The Input Switch (Q1) is turned off. | <ol style="list-style-type: none"> 1. Check if the Input Switch (Q1) is turned off. If yes, turn it on. 2. If the Input Switch (Q1) is turned on but the alarm still exists, contact service personnel. |

| No. | Alarm Message | Possible Cause | Solution |
|-----|--|---------------------------------------|---|
| 54 | BYPASS BREAKER OFF | The Bypass Switch (Q2) is turned off. | <ol style="list-style-type: none"> 1. Check if the Bypass Switch (Q2) is turned off. If yes, turn it on. 2. If the Bypass Switch (Q2) is turned on but the alarm still exists, contact service personnel. |
| 55 | PWR UNIT #n PFC INPUT CURRENT UNBALANCE | PFC is abnormal. | Contact service personnel. |
| 56 | INHIBIT ECO TRANSFER | Bypass source quality is not good. | Please check the bypass source. |
| 57 | PWR UNIT #n CHARGER FUSE BLEW | Charger is abnormal. | Contact service personnel. |
| 58 | PWR UNIT #4 INV CURRENT SHARING ABNORMAL | IVN is abnormal. | Contact service personnel. |



NOTE:

If all possible causes are eliminated but the alarm still appears, please contact your local dealer or customer service.

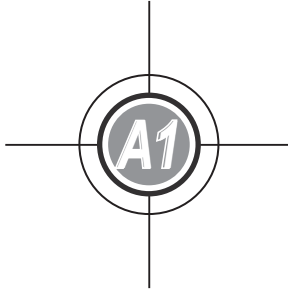

Technical Specifications

| Model | | DPS-160K | DPS-200K |
|-------------|----------------------------------|--|----------|
| Input | Nominal Voltage | 220/380, 230/400, 240/415 Vac (3Φ4W) | |
| | Voltage Range | 140~276/ 242~477 Vac *1 | |
| | Frequency | 50/60 Hz | |
| Output | Nominal Voltage | 220/380, 230/400, 240/415 Vac (3Φ4W) | |
| | Voltage Harmonic Distortion | ≤ 1.5% (linear load) | |
| | Power Factor | 0.9 | |
| | Frequency | 50/60 Hz | |
| | Overload Capability | <125% : 10 minutes, <150% : 1 minute, >150% : 1 second | |
| Display | | LED indicators; LCD (multi-language supported) | |
| Interface | Standard | USB port x 1, RS-232 port x 1, Smart slot x 2, Output dry contact x 6, Input dry contact x 2, Battery cabinet temperature sensor port x 4, Battery cabinet status sensor port x 1, External breaker status detection port x 1, Parallel port x 1, REPO x 1 | |
| Efficiency | Online Mode | Up to 96% | |
| | ECO Mode | Up to 99% | |
| Battery | Nominal Voltage | 240Vdc | |
| | Charge Voltage _ Float Charge | ±272V (±2Vdc) | |
| | Charge Voltage _ Boost Charge | ±280V (±2Vdc) | |
| | Charge Current | 65A | |
| Environment | Operating Altitude | 1000 meters (without derating) | |
| | Operating Temperature | 0 ~ 40°C | |
| | Relative Humidity | < 95% (non-condensing) | |
| | Audible Noise | < 76 dBA (at one meter) | |
| | IP Degree of Protection | IP 20 | |
| Others | Parallel Redundancy & Expansion | Yes | |
| | Emergency Power Off | Yes | |
| Physical | Dimensions (W x D x H) | 850 x 865 x 1950 mm | |
| | Weight | 580 kg | |



NOTE:

1. Please refer to the rating label for the safety rating.
2. All specifications are subject to change without prior notice.

*1: When the total load is 70%~100% of the UPS capacity, the allowable input voltage range could be down to 140/242~187/324Vac.

The logo consists of a central circle containing the text 'A2'. This circle is surrounded by a larger, fainter circle. Four thin lines extend from the center of the circles towards the top, bottom, left, and right edges of the page.

Warranty

Seller warrants this product, if used in accordance with all applicable instructions, to be free from original defects in material and workmanship within the warranty period. If the product has any failure problem within the warranty period, Seller will repair or replace the product at its sole discretion according to the failure situation.

This warranty does not apply to normal wear or to damage resulting from improper installation, operation, usage, maintenance or irresistible force (i.e. war, fire, natural disaster, etc.), and this warranty also expressly excludes all incidental and consequential damages.

Maintenance service for a fee is provided for any damage out of the warranty period. If any maintenance is required, please directly contact the supplier or Seller.



WARNING!

The individual user should take care to determine prior to use whether the environment and the load characteristic are suitable, adequate or safe for the installation and the usage of this product. The User Manual must be carefully followed. Seller makes no representation or warranty as to the suitability or fitness of this product for any specific application.

No. 501324080202
Version : V 2.2
Release Date : 2018_09_28



5013240802