

The power behind competitiveness

Delta UPS - Amplon Family

RT Series, Single Phase
5/ 6/ 8/ 10 kVA

User Manual

www.deltapowersolutions.com

 **DELTA**
Smarter. Greener. Together.

SAVE THIS MANUAL

This manual contains important instructions and warnings that you should follow during the installation, operation, storage and maintenance of this product. Failure to heed these instructions and warnings will void the warranty.

Copyright © 2019 by Delta Electronics Inc. All Rights Reserved. All rights of this User Manual (“Manual”), including but not limited to the contents, information, and figures are solely owned and reserved by Delta Electronics Inc. (“Delta”). The Manual can only be applied to the operation or the use of this product. Any disposition, duplication, dissemination, reproduction, modification, translation, extraction, or usage of this Manual in whole or in part is prohibited without the prior written permission of Delta. Given that Delta will continuously improve and develop the product, changes may be made to the information in this Manual at any time without obligation to notify any person of such revision or changes. Delta will make all possible efforts to secure the accuracy and the integrity of this Manual. Delta disclaims any kinds or forms of warranty, guarantee, or undertaking, either expressly or implicitly, including but not limited to the completeness, faultlessness, accuracy, non-infringement, merchantability or fitness for a particular purpose of the Manual.

Table of Contents

Chapter 1 : Important Safety Instructions -----	1
1.1 Safety Instructions-----	1
1.2 Standard Compliance-----	4
1.3 Storage-----	4
Chapter 2 : Introduction -----	5
2.1 General Overview -----	5
2.2 Exterior & Dimensions-----	5
2.3 Package List -----	6
Chapter 3 : Operation Panel-----	8
3.1 LED Indicators-----	8
3.2 Multi-function Buttons-----	9
3.3 LCD Display-----	12
3.3.1 Icon/ Display Definition-----	13
3.3.2 Operation Mode Diagram Definition -----	14
Chapter 4 : Rear Panel -----	16
Chapter 5 : Communication Interfaces -----	21
5.1 RS-232 Port-----	21
5.2 REPO Port-----	22
5.3 MINI Slot -----	22
5.4 USB Port-----	22
5.5 Dry Contacts -----	23
5.6 External Battery Connector -----	23
Chapter 6 : Installation -----	26
6.1 Rack Mounting -----	26
6.2 Tower Mounting -----	28
6.3 PDB Disassembly & Installation -----	30
6.3.1 Precautions Prior to PDB Disassembly -----	30

6.3.2	PDB Disassembly	31
6.3.3	PDB Assembly	32
6.3.4	PDB Rack-installation	32
6.4	Battery/ Battery Pack Replacement	33
Chapter 7 : Connection and Wiring		35
7.1	UPS Connection Warnings	35
7.2	Input/ Output Connection	36
Chapter 8 : Operation		39
8.1	Start-up	39
8.2	Turn-off	41
8.3	Operation Mode	42
Chapter 9 : LCD Display & Settings		43
9.1	Initial Setting Screen	43
9.2	Main Menu	45
9.2.1	Measurement Menu	48
9.2.2	Setting Menu	48
9.2.3	Control Menu	54
9.2.4	Maintenance Menu	55
Chapter 10 : Optional Accessories		60
Chapter 11 : Troubleshooting		61
Chapter 12 : Maintenance		63
12.1	UPS	63
12.2	Batteries	63
12.3	Fans	64
Appendix 1 : Technical Specifications		65
Appendix 2 : Warranty		68

Chapter 1 : Important Safety Instructions

1.1 Safety Instructions

Installation Warnings





- Before installation and usage, please read this **User Manual** thoroughly. This helps you to use the product correctly and safely.
- Install the UPS in a well-ventilated area, away from excess moisture, heat, dust, flammable gas or explosives.
- To avoid fire accidents and electric shock, please install the UPS in a temperate and humidity well-controlled indoor area free of conductive contaminants. For the temperature and humidity specifications, please refer to **Appendix 1 : Technical Specifications**.
- Leave adequate space (at least 50cm) around all sides of the UPS for proper ventilation.

Connection Warnings

- The UPS must be well grounded due to a possible risk of current leakage.
- The installation of upstream and downstream protective devices is highly recommended when the UPS is connected to the mains and the loads.
- The protective devices connecting to the UPS must be installed near the UPS and must be easily accessible for operation.
- If you need to move the UPS or perform re-wiring, please turn off the AC input power and ensure that the UPS has been safely shutdown. Otherwise, the output end might still be energized, which might cause electric shock.

Usage Warnings

- This is a class-A product. In a domestic environment, this product may cause radio interference, in which case, the user is required to take adequate measures.
- The UPS can be used to power computers and associated peripheral devices, such as monitors, modems, cartridge tape drives, external hard drives, etc.



- It is strictly forbidden to connect the UPS with:
 1. Any regenerative loads.
 2. Any asymmetrical loads.
- To ensure reliable operation of the UPS and to protect the UPS from overheating, the slits and openings in the UPS must not be blocked or covered.
- Before usage, you must allow the UPS to adjust to room temperature for at least one hour to avoid moisture condensing inside the UPS.
- Do not pour and splash any liquid on the UPS. Do not insert any object into the UPS's slits and openings. Do not put beverage containers on or around the UPS.
- When an emergency occurs, (1) press and hold the **ON/ OFF** button () for 3 seconds, (2) release it after you hear one beep, (3) use the Scrolling UP or Down button ( / ) to select 'Yes', and (4) press the Enter button () to confirm your selection to turn off the UPS. After that, cut off the input power to completely shut down the UPS.
- Do not use any cleaning liquid or cleaning spray to clean the UPS. Before cleaning, please make sure that the UPS has been completely shut down, the UPS's input power cord has been unplugged, and the batteries have been disconnected.
- All maintenance services must be performed by qualified service personnel.
- Forbid opening or removing the cover of the UPS yourself to avoid high voltage electric shock.
- You must contact qualified service personnel if either of the following events occurs:
 1. Liquid is poured or splashed on the UPS.
 2. The UPS does not run normally after this **User Manual** is carefully observed.



NOTE :

If you use the UPS in an area that generates or incurs dust, you should install a dust filter (optional) in the 5/ 6kVA UPS and two in the 8/ 10kVA UPS to ensure normal product life and function.

Battery Warnings

- Keep the batteries away from heat sources. Do not open or mutilate the batteries.
- Do not dispose of batteries in a fire. The batteries may explode.
- The released electrolyte is harmful to the skin and eyes and may be toxic.
- A battery can present a risk of electric shock and high short-circuit current.
- Servicing of batteries and battery packs must be performed or supervised by qualified service personnel knowledgeable in batteries, battery packs and the required precautions. Keep unauthorized personnel away from batteries and battery packs.
- The risk of electric shock and short-circuit current is possible when the batteries are connected to the UPS. Before maintenance, disconnect all batteries to cut off the battery power.
- For battery replacement, only use the same number and type of batteries.
- Observe the following before replacing the batteries:
 1. Remove watches, rings, or other metal objects.
 2. Use tools with insulated handles.
 3. Wear rubber gloves and boots.
 4. Do not lay tools or metal parts on the top of batteries.
 5. Disconnect charging source prior to connecting or disconnecting battery terminals.
 6. Remove battery grounds during installation and maintenance to reduce likelihood of shock. Remove the connection from ground if any part of the battery is determined to be grounded.
- Do not connect the batteries in reverse; otherwise, a risk of electric shock or fire accidents might occur.
- The batteries might lose their power during shipment or storage. Before you use the UPS for the first time, please fully charge the batteries until the battery capacity percentage shown on the UPS's LCD is 100% ( 100%). If the UPS needs to be stored for an extended period of time, please charge the batteries every three months and ensure that, every time after charging, the battery capacity percentage shown on the UPS's LCD is 100% ( 100%).



WARNING:

1. The risk of electric shock and short-circuit current is possible when the batteries are still connected to the UPS even though the UPS is disconnected from the mains. Do not forget to cut off the battery source before maintenance.
2. When the UPS is connected to external battery packs, the installation of appropriate protective devices, such as a DC fuse or a DC non-fuse breaker, is required.

1.2 Standard Compliance





- CE
- EN 62040-1
- UL, cUL
- EN 62040-2 Category C2

1.3 Storage

• Prior to installation

If the UPS needs to be stored prior to installation, it should be placed in a dry and well-ventilated area. The allowable storage temperature is between -15°C and $+50^{\circ}\text{C}$ ($5^{\circ}\text{F}\sim 122^{\circ}\text{F}$).

• After usage

(1) Press and hold the **ON/ OFF** button () for 3 seconds, (2) release it after you hear one beep, (3) use the Scrolling UP or Down button ( / ) to select 'Yes', and (4) press the Enter button () to confirm your selection to turn off the UPS. Make sure the UPS is shutdown, disconnect the UPS from the utility AC power, remove all loads/ equipment from the UPS, and store the UPS in a dry and well-ventilated area at a temperature between -15°C and $+50^{\circ}\text{C}$ ($5^{\circ}\text{F}\sim 122^{\circ}\text{F}$).

Idle batteries must be recharged fully approximately every three months if the UPS needs to be stored for an extended period of time. Ensure that, every time after charging, the battery capacity percentage shown on the UPS's LCD is 100% ()



NOTE :

After storage and before start-up of the UPS, you must allow the UPS to adjust to room temperature ($20^{\circ}\text{C}\sim 25^{\circ}\text{C}$ or $68^{\circ}\text{F}\sim 77^{\circ}\text{F}$) for at least one hour to avoid moisture condensing inside the UPS.

Chapter 2 : Introduction

2.1 General Overview

The RT series UPS is a single-phase input, single-phase output on-line uninterruptible power supply which provides reliable and consistent sine-wave quality power to your electronic equipment. It adopts the latest technology and the highest quality components providing output power factor up to unity, and its efficiency in on-line mode reaches up to 95.5%. The UPS not only provides safe, reliable and uninterrupted power to your sensitive electronic equipment at all times, but also produces greater electronic power efficiency at less cost. There are four different ratings, 5kVA, 6kVA, 8kVA and 10kVA, for your selection.

2.2 Exterior & Dimensions

The product that you receive is composed of three parts, a UPS, a battery pack and a PDB (Power Distribution Box). Please refer to **Figure 2-1** and **Figure 2-2**.



NOTE :

When handling or moving the product, please note that the force area of the product is at the bottom of the battery pack, but not at the PDB.

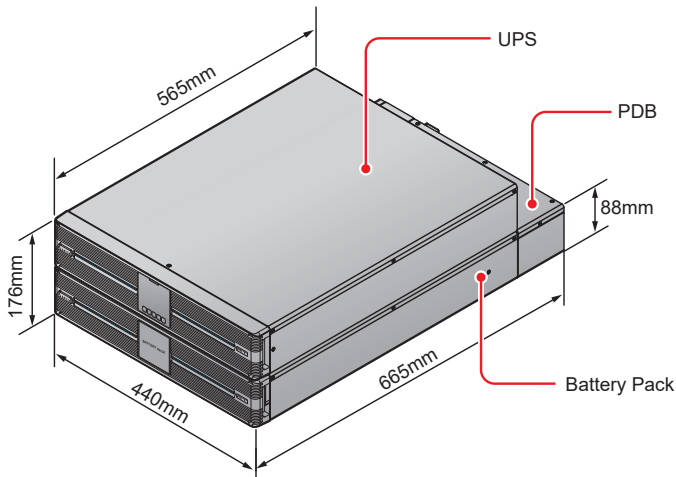

(Figure 2-1: Standard Runtime Model - 5/ 6KVA Exterior & Dimensions)

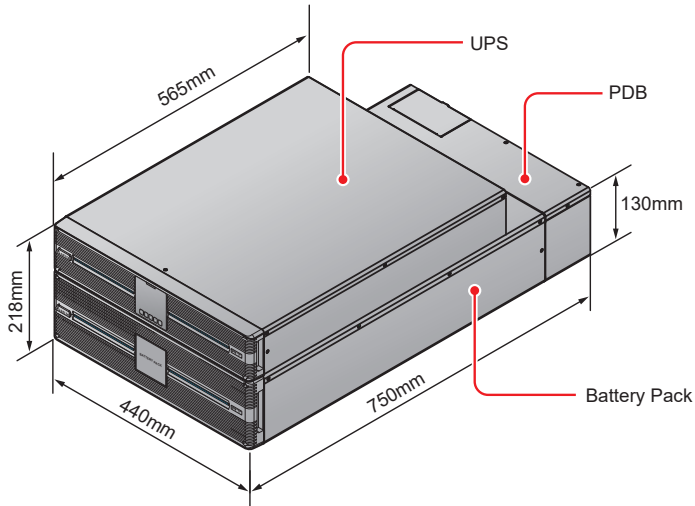

(Figure 2-2: Standard Runtime Model - 8/ 10KVA Exterior & Dimensions)

2.3 Package List

The package contains the following items. Please check if any item is missing. If there is anything missing, please contact the dealer immediately.

**Models: UPS502R2RT0B0B8/ UPS602R2RT0B0B8/ UPS802R2RT0B0B8/
UPS103R2RT0B0B8/ UPS502R2RT0B035/ UPS602R2RT0B035/
UPS802R2RT0B035/ UPS103R2RT0B035**

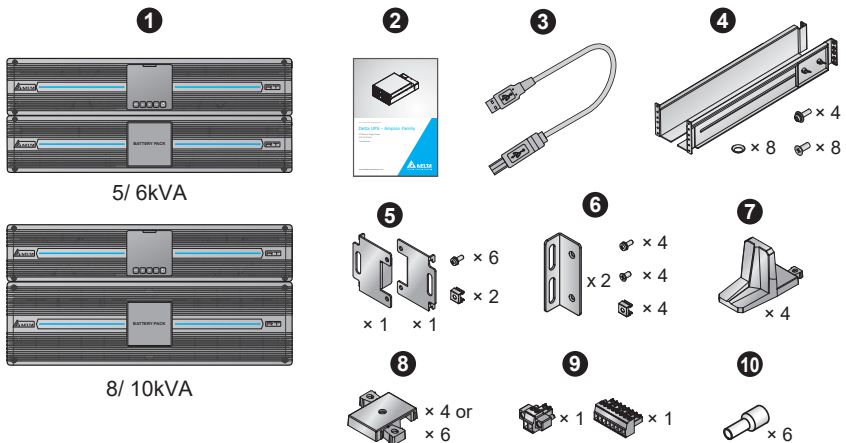

No.	Item	5kVA (0B8)	6kVA (0B8)	8/ 10kVA (0B8)	5/ 6kVA (035)	8/ 10kVA (035)
①	UPS	1 PC	1 PC	1 PC	1 PC	1 PC
②	User Manual	1 PC	1 PC	1 PC	1 PC	1 PC
③	USB Cable	1 PC	1 PC	1 PC	1 PC	1 PC
④	Rail Kit	1 SET	1 SET	1 SET	N/A	N/A
⑤	Bracket Ear for PDB	1 SET	1 SET	1 SET	1 SET	1 SET
⑥	Bracket Ear for UPS	1 SET	1 SET	1 SET	1 SET	1 SET
⑦	Tower Stand	4 PCS	4 PCS	4 PCS	4 PCS	4 PCS
⑧	Tower Stand Expander	4 PCS	4 PCS	6 PCS	4 PCS	6 PCS
⑨	Pluggable Terminal	2 PCS	2 PCS	2 PCS	2 PCS	2 PCS
⑩	Cord End Terminal	N/A	6 PCS	6 PCS	6 PCS	6 PCS



NOTE:

1. If there is any damage or anything missing, please immediately contact the dealer from whom you purchased the unit.
2. If the UPS needs to be returned, carefully repack the UPS and all of the accessories using the original packing material that came with the unit.

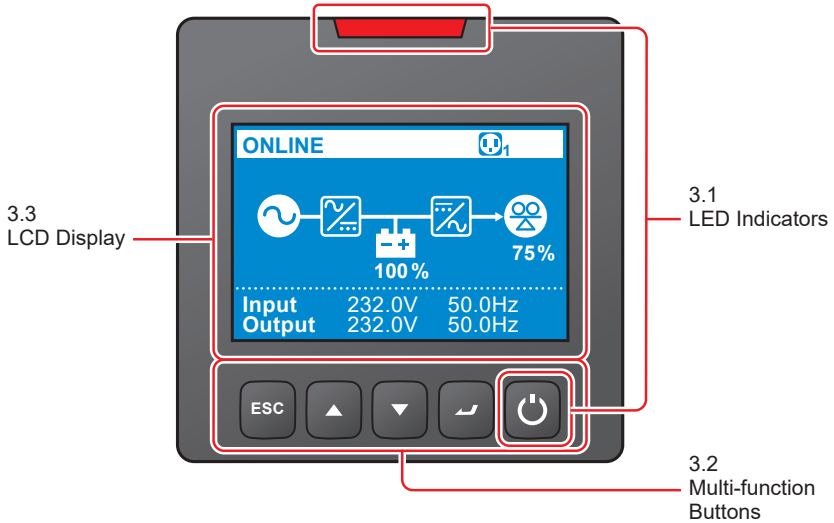

Chapter 3 : Operation Panel

On the front panel of the UPS, you'll see two LED indicators, a LCD display, and multi-function buttons.







(Figure 3-1: Operation Panel)



3.1 LED Indicators

No.	LED	Description
1		<ol style="list-style-type: none"> ON: The output is protected. OFF: The output is not protected.
2		<ol style="list-style-type: none"> ON: The UPS detects an internal fault or an environmental fault. OFF: The UPS is in normal state. Flashing: The UPS shows the warning message(s). Please check the corresponding warning message(s) in Chapter 11: Troubleshooting.

3.2 Multi-function Buttons

No.	Multi-function Button	Description
1	 <p>ON/ OFF Button</p>	<p>The button has multiple functions. Please refer to the following for detailed information.</p> <p>1. Turn-on</p> <ul style="list-style-type: none"> • In standby/ bypass mode, press and hold the button for 3 seconds, release it after you hear one beep and the UPS will run in on-line mode. • Cold start: When there is no AC input, press and hold the button for 3 seconds, release it after you hear one beep and the UPS will run in battery mode. <p>2. Turn-off</p> <ul style="list-style-type: none"> • In on-line mode, (1) press and hold the button for 3 seconds, (2) release it after you hear one beep, (3) use the Scrolling UP or Down button (▲ / ▼) to select 'Yes', and (4) press the Enter button (↵) to confirm your selection. After that, the inverter will be off and the UPS will transfer to run in standby or bypass mode. <p>The UPS will keep charging the batteries when the UPS is in standby/ bypass mode. To fully turn off the UPS, it is advised to disconnect the UPS from the AC power.</p> <ul style="list-style-type: none"> • In battery mode, (1) press and hold the button for 3 seconds, (2) release it after you hear one beep, (3) use the Scrolling UP or Down button (▲ / ▼) to select 'Yes', and (4) press the Enter button (↵) to confirm your selection. After that, the UPS will be turned off. <p>3. Fault Clear</p> <ul style="list-style-type: none"> • When the UPS has a fault condition, press and hold the button for 3 seconds, release it after you hear one beep and the UPS will try to clear the fault condition.

No.	Multi-function Button	Description
		 NOTE: <ol style="list-style-type: none"> 1. When the UPS clears the fault condition, it means that the buzzer/ warning message has been turned off. To eliminate the fault detected, please refer to Chapter 11: Troubleshooting for relevant solutions. 2. The function mentioned above is only applicable to the condition when the UPS has a fault situation and the inverter is off.
2	 <p>Enter Button</p>	<p>The button has multiple functions. Please refer to the following for detailed information.</p> <p>1. Entering into the setup mode</p> <p>In the Main Screen (that shows the current operation mode), press the button for 0.1 second and the UPS will enter into the Main Menu (setup mode). Please refer to Chapter 9: LCD Display & Settings.</p> <p>2. Selecting and confirming the parameter in setup mode</p> <p>In setup mode, press the button to choose the parameter you want to change, and the parameter will flash. Press the Scrolling Up or the Scrolling Down button to change the parameter and press the button again to confirm the change.</p>
3	 <p>Scrolling Up Button</p>	<p>The button has multiple functions. Please refer to the following for detailed information.</p> <p>1. Scrolling Up/ Increasing Number</p> <ul style="list-style-type: none"> • In the Main Screen, press the button for 0.1 second and the UPS will directly enter into the Measurement Menu's level 3 (see Figure 9-1: Menu Tree), which contains related Output information. • In setup up mode, the button is used to navigate the setting items. Press the button for 0.1 second to go to the previous setting item.

No.	Multi-function Button	Description
3	 <p>Scrolling Up Button</p>	<ul style="list-style-type: none"> The button is also used to navigate or set up the setting parameter. Press the button for 0.1 second to go to the previous display or to increase a number. If the button is pressed for more than 2 seconds, the number will be increased single digit every 0.2 second automatically until the button is released or the number reaches its highest value. <p>2. LCD Reset</p> <ul style="list-style-type: none"> Press the Scrolling Up and the Scrolling Down buttons together for 3 seconds to reset the LCD display.
4	 <p>Scrolling Down Button</p>	<p>The button has multiple functions. Please refer to the following for detailed information.</p> <p>1. Scrolling Down/ Decreasing Number</p> <ul style="list-style-type: none"> In the Main Screen, press the button for 0.1 second and the UPS will directly enter into the Measurement Menu's level 3 (see Figure 9-1: Menu Tree), which contains related Output information. In setup up mode, the button is used to navigate the setting items. Press the button for 0.1 second to go to the next setting item. The button is also used to navigate or set up the setting parameter. Press the button for 0.1 second to go to the next display or to decrease a number. If the button is pressed for more than 2 seconds, the number will be decreased single digit every 0.2 second automatically until the button is released or the number reaches its lowest value. <p>2. LCD Reset</p> <ul style="list-style-type: none"> Press the Scrolling Up and the Scrolling Down buttons together for 3 seconds to reset the LCD display.

No.	Multi-function Button	Description
5	 Escape Button	<p>The button has multiple functions. Please refer to the following for detailed information.</p> <ul style="list-style-type: none"> • Back to the Previous Menu Level In setup mode, press the button for 0.1 second to go back to the previous menu level.









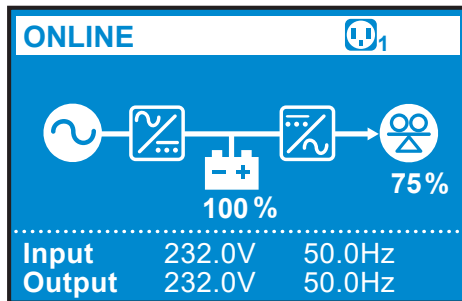

NOTE:

If the LCD display goes dim, press any button mentioned above for 0.1 second to wake up the LCD display and enable each button function.





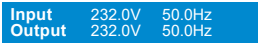
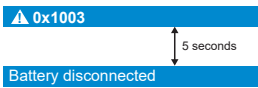



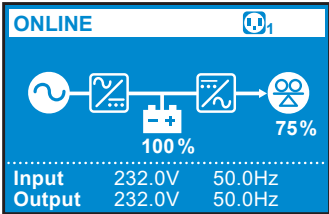

3.3 LCD Display

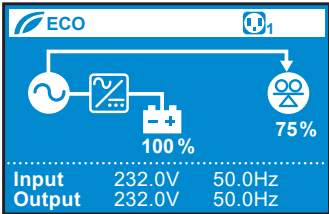

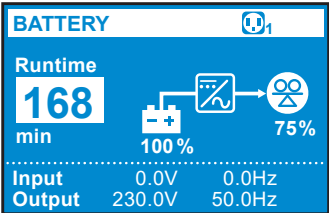

3.3.1 Icon/ Display Definition

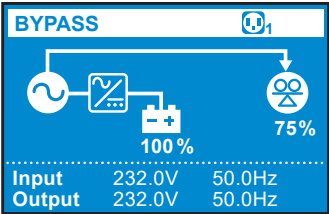
No.	Icon/ Display	Description
1		Indicates that the load bank status is ON.
		Indicates that the load bank status is OFF.
2		Indicates the battery capacity level.
		Indicates that the battery is abnormal and needs replacement. If the battery is abnormal, the battery capacity icon () will be off.
3		Indicates the load level (%).
4		When the UPS runs normally, the display will show the input/ output voltage and frequency.
		When the UPS has abnormalities or is in fault condition, the display will show an error code and its corresponding fault or warning message.  NOTE : The error code and the fault/ warning message will appear alternatively for every 5 seconds.
5		Indicates that the buzzer is muted.

3.3.2 Operation Mode Diagram Definition

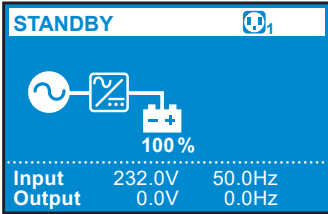
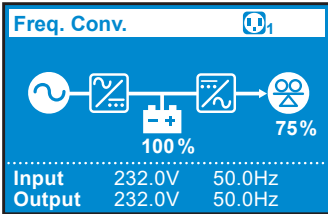
No.	Diagram	Description
1	 <p>ONLINE </p> <p>Input 232.0V 50.0Hz Output 232.0V 50.0Hz</p>	Indicates ONLINE mode.
2	 <p>ECO </p> <p>Input 232.0V 50.0Hz Output 232.0V 50.0Hz</p>	Indicates ECO mode.  NOTE: In ECO mode, the diagram's power flow will change according to the UPS input voltage and frequency. However, the ECO icon () shown on the upper-left corner will not change even if the UPS transfers to online mode or battery mode.
3	 <p>BATTERY </p> <p>Runtime 168 min</p> <p>Input 0.0V 0.0Hz Output 230.0V 50.0Hz</p>	Indicates BATTERY mode.
4	 <p>BYPASS </p> <p>Input 232.0V 50.0Hz Output 232.0V 50.0Hz</p>	Indicates BYPASS mode.

No.	Diagram	Description
5	 <p>The diagram shows a blue panel with the text 'STANDBY' and a battery icon in the top right. The main area contains an AC input symbol, a battery icon with a plus sign, and '100%' below it. At the bottom, a table shows: Input 232.0V 50.0Hz, Output 0.0V 0.0Hz.</p>	<p>Indicates AC STANDBY mode.</p>
6	 <p>The diagram shows a blue panel with the text 'Freq. Conv.' and a battery icon in the top right. The main area contains an AC input symbol, a battery icon with a plus sign and '100%' below it, an inverter symbol, and an output symbol with '75%' below it. At the bottom, a table shows: Input 232.0V 50.0Hz, Output 232.0V 50.0Hz.</p>	<p>Indicates Frequency Conversion mode.</p> <p> NOTE: In Frequency Conversion mode, the diagram's power flow will change according to the UPS input voltage and frequency. However, the text Freq. Conv. (Freq. Conv.) shown on the upper-left corner will not change even if the UPS transfers to battery mode.</p>

Chapter 4 : Rear Panel

- Model: UPS502R2RT0B0B8

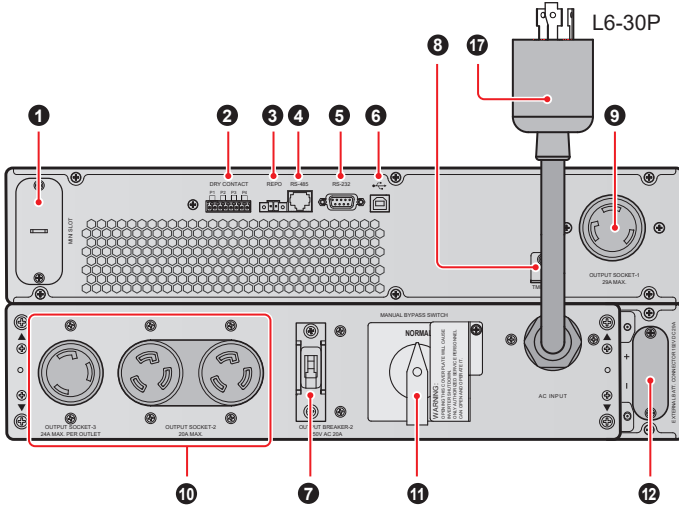

(Figure 4-1: 5kVA Rear Panel)

- Model: UPS602R2RT0B0B8

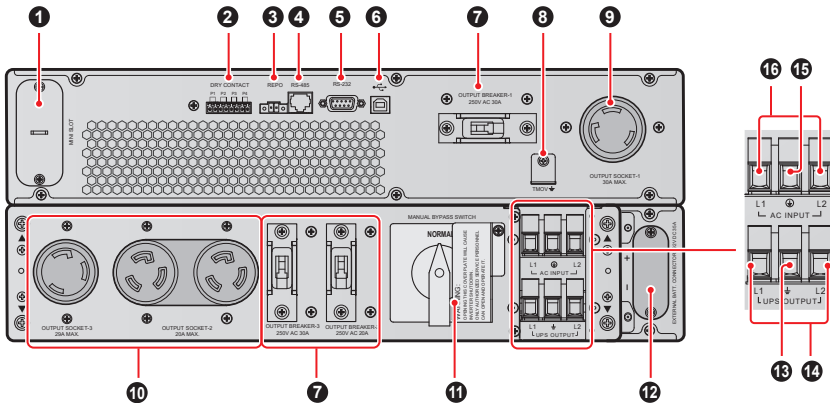

(Figure 4-2: 6kVA Rear Panel)

• Models: UPS502R2RT0B035 & UPS602R2RT0B035

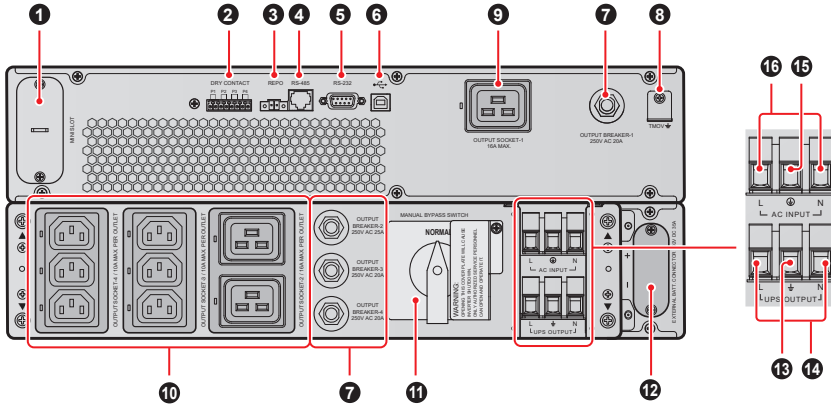

(Figure 4-3: 5kVA/ 6kVA Rear Panel)

• Models: UPS802R2RT0B0B8 & UPS103R2RT0B0B8

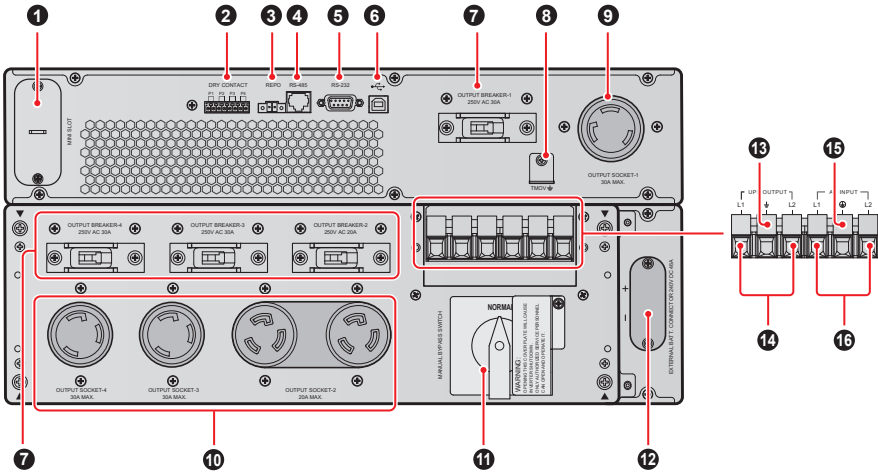



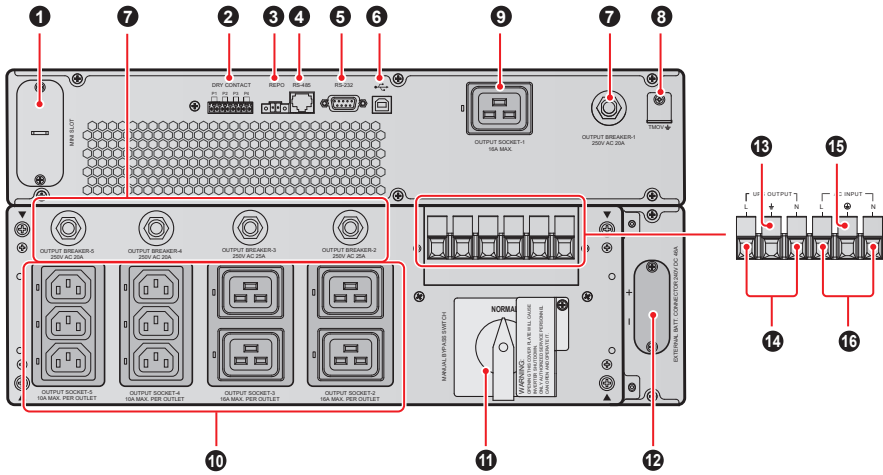

(Figure 4-4: 8kVA/ 10kVA Rear Panel)

• Models: UPS802R2RT0B035 & UPS103R2RT0B035



(Figure 4-5: 8kVA/ 10kVA Rear Panel)

No.	Item	Functions
1	MINI Slot	Connects to a Mini SNMP IPv6 / Mini Relay I/O / Mini MODBUS card. For more information, please refer to 5.3 MINI Slot .
2	Dry Contacts	<ol style="list-style-type: none"> 1. Output dry contacts: Receive the UPS's event information to indicate the UPS status or internal messages. 2. Input dry contacts: Let the UPS to receive external control signals. 3. For more information, please refer to 5.5 Dry Contacts.
3	REPO Port	When emergency events occur, it can shut down the UPS safely and immediately. Please refer to 5.2 REPO Port for details.
4	RS-485 Port	Connects to a computer so you can monitor the UPS status.

No.	Item	Functions
5	RS-232 Port	<p>Connects to a computer so you can build up RS-232 communication, configure the UPS and upgrade the UPS firmware.</p> <p>Please refer to 5.1 RS-232 Port for more information.</p> <p> NOTE: The USB port and the RS-232 port must not be used simultaneously.</p>
6	 (USB Port)	<p>Connects to a computer so you can monitor the state of the UPS, configure the UPS parameters and update the management software. Please refer to 5.4 USB Port for more information.</p> <p> NOTE: The USB port and the RS-232 port must not be used simultaneously.</p>
7	Output Breaker(s)	Prevent(s) the output socket from damage caused by overload.
8		For input TMOV's grounding.
9	Output Socket (with load bank function)	Connects to the loads.
10	Output Sockets	Connect to the loads.
11	Manual Bypass Switch	Switches the UPS into manual bypass mode for maintenance without power supply interruption.
12	External Batt. Connector	<p>Connects to the external battery pack (optional).</p> <p>5K: 192V DC 29A 6K: 192V DC 35A 8K: 240V DC 37A 10K: 240V DC 46A</p>

No.	Item	Functions
13	⊥	For loads' grounding.
14	UPS Output Terminal Block* (L1 & L2 for suffix B8 model; L & N for suffix 35 model)	Connects to the loads.
15	⊕	For UPS grounding.
16	AC Input Terminal Block* (L1 & L2 for suffix B8 model; L & N for suffix 35 model)	Connects to the mains.
17	Input Power Cord	Connects to a wall socket.



NOTE :

* Remove the terminal cover plate and you will see the wiring terminal blocks.

Chapter 5 : Communication Interfaces



NOTE :

1. The UPS can still function properly without making the connections below.
2. For the location of the following communication interfaces, please refer to *Figure 4-1~Figure 4-5*.

5.1 RS-232 Port

You can use a RS-232 cable (user supplied) to connect the UPS with a computer and install the UPSentry 2012 software*¹ to check and monitor the UPS status.

- **The RS-232 port provides the following functions**

1. RS-232 communication (baud rate: 2400/ 9600)
2. UPS configuration
3. Firmware upgrade (baud rate: 9600)

- **Pin Assignment**

1. PIN 2: TXD <Transmitting Data>
2. PIN 3: RXD <Receiving Data>
3. PIN 5: GND <Signal Ground>

- **Hardware**

1. Baud Rate: 2400/ 9600bps
2. Data Length: 8 bit
3. Stop Bit: 1 bit
4. Parity: None



NOTE :

1. *¹ You can download the software from the following link:
<http://www.deltapowersolutions.com/en/mcis/ups-software.php>.
2. Do not use the USB port and the RS-232 port simultaneously. If you connect the USB cable (user-supplied) to the USB port, the RS-232 port will be disabled right away.

5.2 REPO Port

The REPO port can be connected to an external switch. After the external switch is turned to the '**CLOSED**' position, the UPS will switch off the inverter immediately and cut off the UPS output without transferring to bypass mode.



NOTE:

1. You can use the management software to configure the REPO port as normally open (NO) or normally closed (NC). The factory default setting is normally open (NO).
2. The REPO port can also be used for ROO application, which allows you remotely turn on/ off the inverter. If you need detailed ROO information or ROO setup service, please contact your local dealer or customer service. Please note that this port can only be modified by qualified service personnel.

5.3 MINI Slot

The MINI slot is for mini-size cards. You can install the Mini SNMP IPv6, Mini Relay I/O, or Mini MODBUS card in this slot to let the system have network communication, dry contact function, and MODBUS communication respectively.

5.4 USB Port

Please use the provided USB cable to connect the UPS with a computer and install the UPSentry 2012 software*1 to check and monitor the UPS status. The USB port has the following functions:

1. HID USB communication
2. UPS configuration with EEPROM programming
3. UPS firmware upgrade
4. Event logs download
5. Dry contacts setup



NOTE:

1. *1 You can download the software from the following link:
<http://www.deltapowersolutions.com/en/mcis/ups-software.php>.
2. Do not use the USB port and the RS-232 port simultaneously. If you connect the USB cable (user-supplied) to the USB port, the RS-232 port will be disabled right away.

5.5 Dry Contacts

The RT UPS provides one input dry contact for you to receive external control signals. You can set up relevant items in the **Dry Contact Setting** screen, which includes Disable/ ROO/ RPO/ Remote shutdown/ Forced bypass/ On generator. Besides, there are three configurable output dry contacts for you to receive UPS events. The output dry contacts are normally open (NO). You can set up relevant items in the **Dry Contact Setting** screen, which includes Disable/ On bat/ Low bat/ Bat fault/ Bypass/ UPS OK/ Load protected/ Load powered/ General alarm/ Overload alarm. Please refer to **9.2.2 Setting Menu** and **9.2.4 Maintenance Menu** for relevant information.

5.6 External Battery Connector

The connector is for connection to the external battery pack(s). Please see below for relevant information.

- **Battery**

UPS	Charge Voltage	Charge Current	Low Battery Shutdown	The Number Of Batteries
5kVA/ 6kVA	219.2Vdc	1A (default)	168V±3%	12V × 16 PCS
8kVA/ 10kVA	274Vdc	1.5A (default)	210V±3%	12V × 20 PCS



WARNING:

1. Please refer to the table below to select the charge current for 5kVA/ 6kVA/ 8kVA/ 10kVA UPS.
2. If you need to modify the charge current default setting, please contact your local dealer or customer service.

5kVA/ 6kVA UPS	Level 1	Level 2	Level 3	Level 4
Total Battery Capacity	5~9Ah	9~17Ah	18~30Ah	27~40Ah
Charge Current	1A	2A	3A	4A

8kVA/ 10kVA UPS	Level 1	Level 2	Level 3	Level 4
Total Battery Capacity	9~17Ah	17~20Ah	20~30Ah	27~40Ah
Charge Current	1.5A	2A	3A	4A

- **External Battery Pack**

1. To increase the battery backup time, you can connect several external battery packs to the UPS.
2. Delta external battery pack is optional. Please refer to the Quick Guide, User Manual or Installation & Operation Guide included in the package of the external battery pack.
3. When connecting the external battery pack with the UPS, you must install an appropriate non-fuse DC breaker or the fast-acting fuse that meets the safety certification. Do not use an AC breaker.
4. The breaker must be a 2-pole non-fuse DC breaker with characteristics of 1-pole 250Vdc, 2-pole 500Vdc and 35kA (or above) DC breaking capacity.

- **Battery/ Battery Pack Connection Warnings**

1. Only use the same type of batteries from the same supplier. Never use old, new and different Ah batteries at the same time.
2. The number of batteries must meet UPS requirements.
3. Do not connect the batteries in reverse.
4. Use the voltage meter to measure whether the total voltage, after battery pack connection, is around $12.5\text{Vdc} \times$ the total number of batteries.



NOTE :

1. Turn off the UPS and cut off the AC source before performing battery/ battery pack replacement.
2. A battery can present a risk of electric shock and high short-circuit current.
3. Servicing of batteries and battery packs must be performed or supervised by qualified service personnel knowledgeable in batteries, battery packs and the required precautions. Keep unauthorized personnel away from batteries and battery packs.

• Alarm



When any external battery pack connected to the UPS has the following problems, the UPS system will sound an alarm. Please see the table below.

No.	External Battery Pack Status	Description
1	Battery Mode	The alarm beeps once every 2 seconds.
2	Battery Low Warning	The alarm beeps once every 0.5 second.
3	Battery Missing/ Weak Battery/ Battery Replacement	The alarm beeps once every 2 seconds.
4	Overload	1. Overload_105%~125%: The alarm beeps once every 2 seconds. 2. Overload_125%~150%: The alarm beeps once every 0.5 second.
5	Fault	The alarm beeps continuously for 5 seconds when the UPS detects an internal fault. After the 5-seconds long beep, the alarm beeps once every 2 seconds.



NOTE :

*: After reconnecting or replacing the batteries, it might take a while for the UPS to switch off the alarm automatically. If, after a period of time, the audible alarm still exists, please manually initiate a battery test. Please follow the route below to execute the manual battery test in order to clear the alarm.

Route: press the button  for 0.1 second → tap the icon  → select **Test** → select **Start Battery Test**. For relevant information, please refer to **9.2 Main Menu**.

Chapter 6 : Installation

Please refer to the system block diagram and related information below for correct installation.

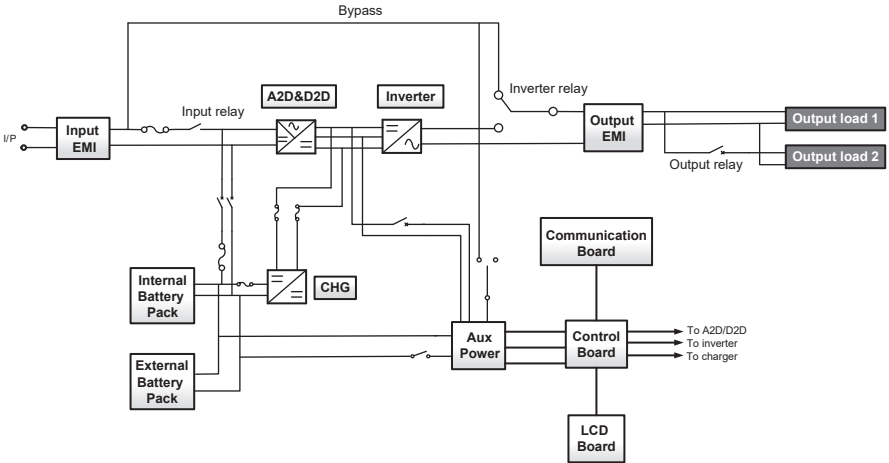

6.1 Rack Mounting

Use the included bracket ears and screws to mount the UPS in a rack by following the procedures below.

- 1 Attach the included bracket ears to the lateral mounting holes of the UPS. See **Figure 6-1**.

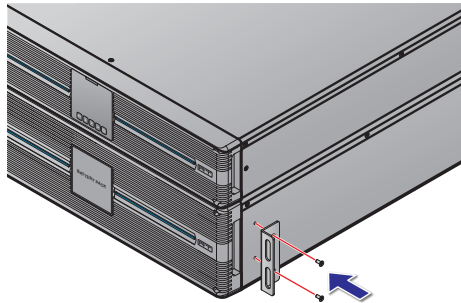

(Figure 6-1: UPS Bracket Ear Installation)

2 Follow steps 1 to 4 to install the UPS in Delta's rail kit (optional). See **Figure 6-2**.

Step 1 : Adjust the length of the rail according to the rack.

Step 2 : Tighten the nuts.

Step 3 : Fix the rail on the rack.

Step 4 : Insert the UPS in the rack and tighten the screws.

3 If you want to use a non-Delta rail kit, please only follow step 4 .

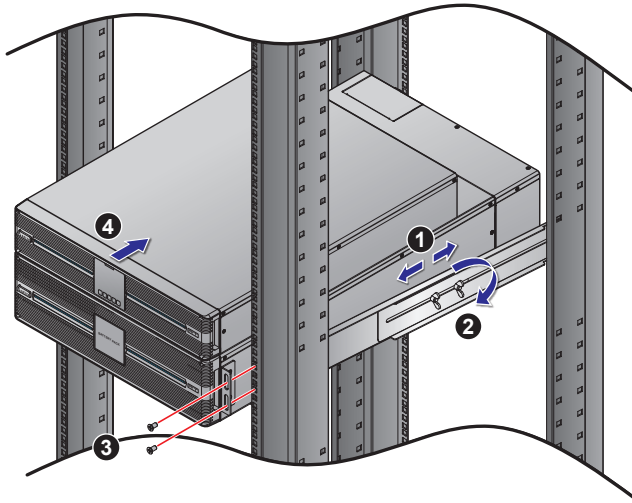

(Figure 6-2: Rack Mounting)



NOTE: If you need the optional rail kit, please contact your local dealer.

6.2 Tower Mounting

Use the included tower stands to mount the UPS in an upright tower position by following the steps below.

- 1 Assemble the tower stands and the tower stand expanders 1 according to the size of the UPS (see **Figure 6-3** & **Figure 6-4**).

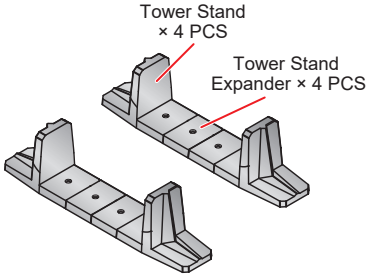

(Figure 6-3: Assemble the Tower Stands for 5/ 6kVA UPS)

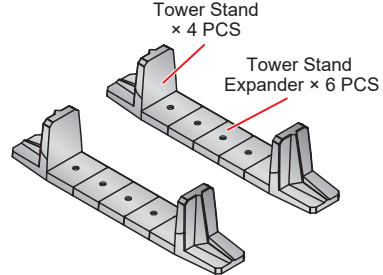

(Figure 6-4: Assemble the Tower Stands for 8/ 10kVA UPS)

- 2 Pull out the two panels and the two Delta logo nameplates 2, rotate them 90° clockwise 3 and re-insert them (see **Figure 6-5**).

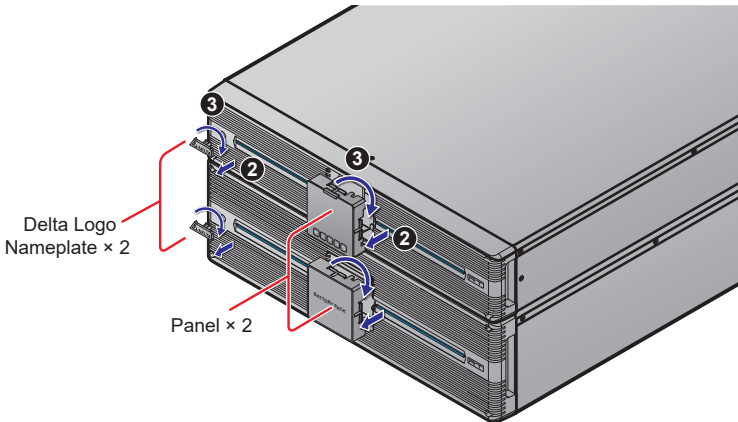

(Figure 6-5: Rotate the Two Panels and Two Delta Logo Nameplates)

- 3 Carefully lift the whole unit upright 4 with the Delta logo nameplates and the icons shown on the panels facing up.

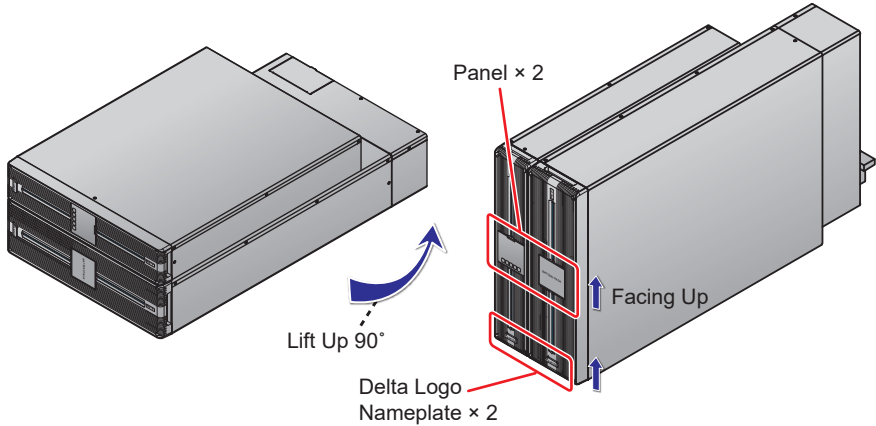

(Figure 6-6: Place the Whole Unit Upright)

- 4 Place the whole unit inside the tower stands 5.

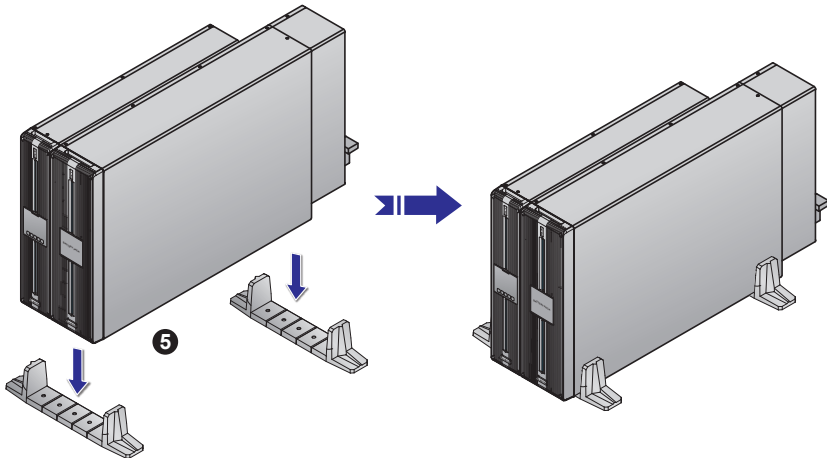

(Figure 6-7: Place the Whole Unit inside the Tower Stands)

Leave adequate space (at least 50 cm) around all sides of the unit for good ventilation.



NOTE: A minimum of two people are required to execute 3 and 4.

6.3 PDB Disassembly & Installation

6.3.1 Precautions Prior to PDB Disassembly

1. The PDB is assembled with the UPS when it is shipped out from the Delta factory. Disassembly of the PDB must be performed by trained professional personnel.
2. To carry out UPS maintenance without interrupting its power supply, please follow the procedures below to turn the PDB's manual bypass switch to the **Bypass** position to let the UPS automatically shut down.
 - 1 Uncrew the screw shown below to remove the cover plate of the manual bypass switch.

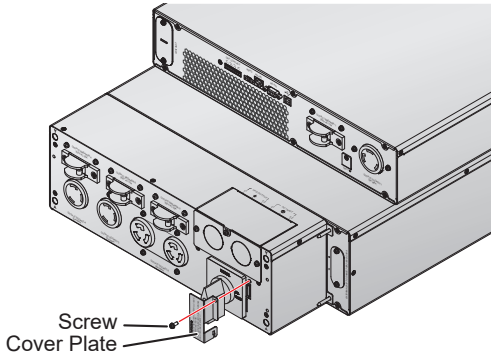

(Figure 6-8: Remove the Cover Plate of the Manual Bypass Switch)

- 2 Turn the manual bypass switch to the **Bypass** position.

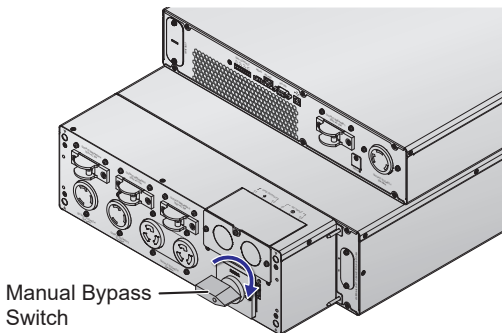

(Figure 6-9: Turn the Manual Bypass Switch to the Bypass Position)

- 3 Remove the battery pack's front bezel and disconnect the battery terminals before disassembling the PDB (see **Figure 6-10**).

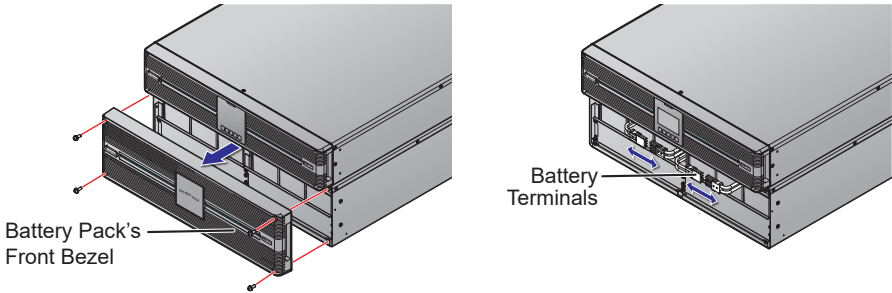

(Figure 6-10: Disconnect the Battery Power)

6.3.2 PDB Disassembly



NOTE:

Before PDB disassembly, please ensure that you have followed **6.3.1 Precautions Prior to PDB Disassembly**.

- 1 Unscrew the four screws from the PDB (see **Figure 6-11_1**).
- 2 Disassemble the PDB from the rear of battery pack (see **Figure 6-11_2**).

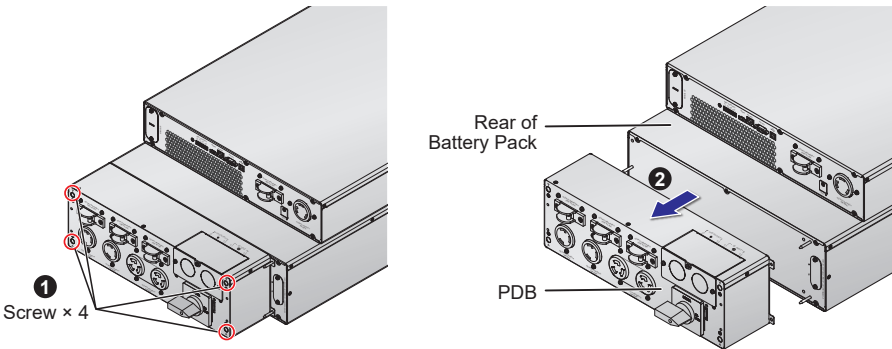

(Figure 6-11: Disassemble the PDB)

6.3.3 PDB Assembly

- 1 Align the PDB's three holes (1) with the three guideposts (2) on the rear of battery pack.
- 2 Attach the PDB to the rear of the battery pack, and use a cross-head screwdriver (3) and four screws (4) to firmly attach the PDB to the rear of battery pack (see **Figure 6-12**).

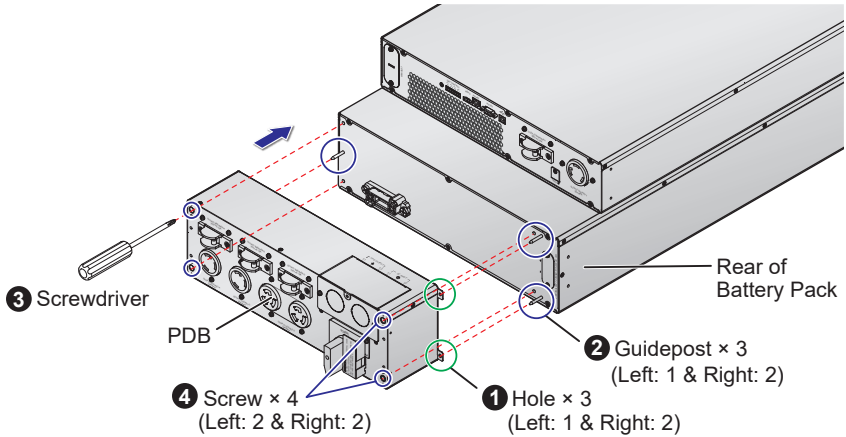

(Figure 6-12: Assemble the PDB)

6.3.4 PDB Rack-installation

If you need to install the PDB on a rack, please follow the steps below.

- 1 Attach the provided mounting brackets to the PDB using the screws that came with the brackets.

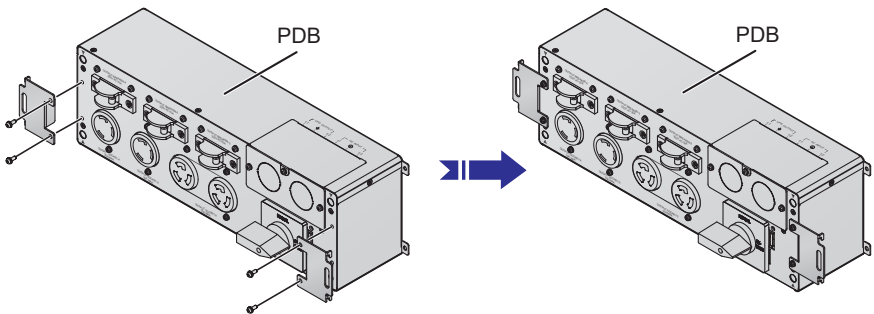

- 2 Attach the provided M5 nuts to the rack. Use the provided M5 screws to firmly install the PDB on the rack. Ensure that the screws are tightly fixed.

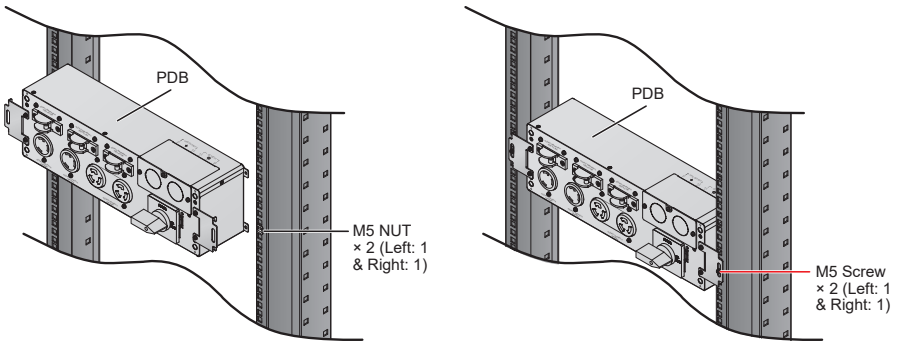

6.4 Battery/ Battery Pack Replacement



NOTE:

1. Turn off the UPS and cut off the AC source before performing battery/ battery pack replacement.
2. A battery can present a risk of electric shock and high short-circuit current.
3. Servicing of batteries and battery packs must be performed or supervised by qualified service personnel knowledgeable in batteries, battery packs and the required precautions. Keep unauthorized personnel away from batteries and battery packs.

Replace the battery/ battery pack by following the procedures below.

- 1 Unscrew the screws and remove the battery pack's front bezel 1.
- 2 Disconnect the battery terminals 2.
- 3 Use the Phillips screwdriver to remove the screws from the protective cover located in front of the battery 3.

- 4 Pull out the battery from the left battery compartment and insert a new one. Follow the same procedure to replace the battery in the right battery compartment 4.



NOTE: A minimum of two people are required to execute 3 and 4.

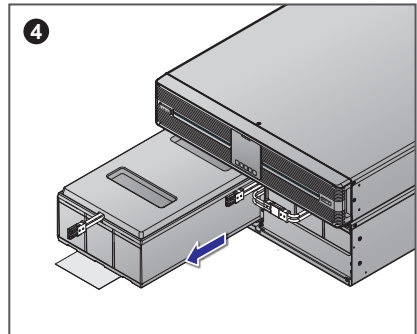
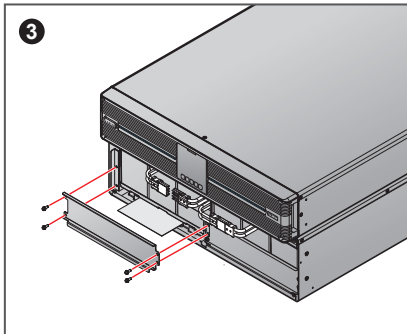
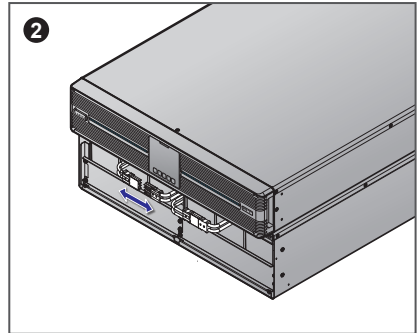
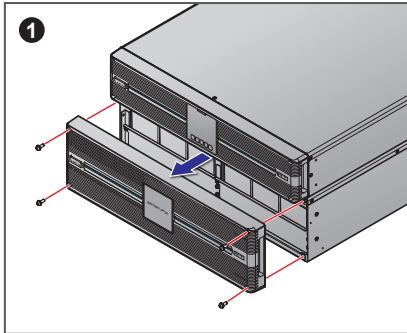

- 5 Reassemble the battery pack in reverse order.

Chapter 7 : Connection and Wiring

7.1 UPS Connection Warnings

- 1 When connecting the UPS to the mains and the loads, it is highly recommended that you install the protective devices. Please refer to the table and diagram below.

UPS Power Rating	Suggested Protective Device	Suggested Supplier
5kVA	D curve-30A circuit breaker	DELIXI
6kVA	D curve-50A circuit breaker	DELIXI
8/ 10kVA	D curve-80A circuit breaker	DELIXI

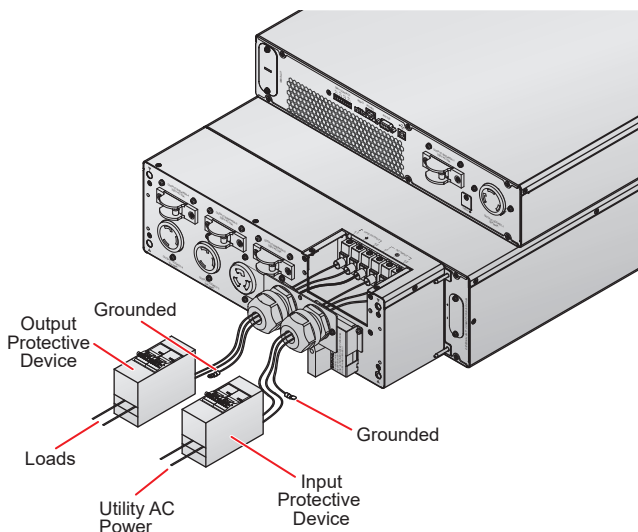

(Figure 7-1: Wiring Diagram)

- 2 The protective devices must use approved components that meet safety certifications.
- 3 The power supplying to the UPS must be single-phase in accordance with the unit's rating label, and the UPS must be properly grounded.

7.2 Input/ Output Connection

1 Please see the figures below for input/ output connection.

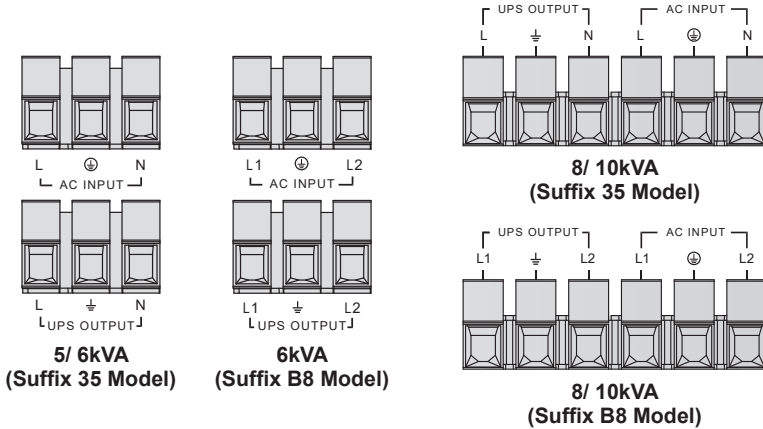

2 Cable Selection:

For the specifications of input/ output cables, please refer to **Table 7-1**.

Table 7-1: Specifications of Input/ Output Cables

Spec. \ Capacity	5/ 6kVA (Suffix: B8)	8/ 10 kVA (Suffix: B8)
Input/ Output Cables (Rating Temperature 90°C)	#8AWG	#6AWG
Tightening Torque (For AC Wiring)	12kgf·cm	25.5kgf·cm
Spec. \ Capacity	5/ 6kVA (Suffix: 35)	8/ 10 kVA (Suffix: 35)
Input/ Output Cables	6mm ²	10mm ²
Tightening Torque (For AC Wiring)	12kgf·cm	18kgf·cm

In accordance with National Electrical Codes (NEC), please install the suitable conduits and cable sleeves.

3 When connecting the input/ output power cords, please observe the following rules.

1. Turn of the UPS and cut off both AC source and the battery source before connection.
2. Calculate the power consumption of the loads to avoid an overload condition.
3. Ensure that the screws are tightly fixed after connection. Please refer to **Table 7-1**.

4 Backfeed Protection:

When the UPS runs in battery mode or during AC power failure, the UPS's inner voltage or energy might be fed back to the input terminals, either directly or via a leakage loop. To avoid the risk of electric shock resulted from the backfeed, installation of a backfeed protection device between the AC input and the UPS is highly recommended.



NOTE:

1. The UPS doesn't have any built-in backfeed protection device. Installation of the backfeed protection device between the AC input and the UPS is highly recommended.
2. If there is no backfeed protection device installed between the AC input and the UPS, please (1) attach a warning label on the switch or breaker that controls the AC power supplying to the UPS, and (2) check if any hazardous voltage exists on any terminals connected to the AC power. The warning label shall carry the following wording or equivalent.

Before Working on This Circuit
 -Isolate Uninterruptible Power System (UPS)
 -Then check for Hazardous Voltage between all terminals including the protective earth.



Risk of Voltage Backfeed

● **Backfeed Protection Device Requirements:**

UPS	Suggested Backfeed Protection Device Rating Voltage/ Current	Suggested Model No.
5/ 6kVA	208/ 220/ 230/ 240Vac 40A	AF52-30-13 (ABB)

UPS	Suggested Backfeed Protection Device Rating Voltage/ Current	Suggested Model No.
8/ 10kVA	208/ 220/ 230/ 240Vac 65A	AF52-30-13 (ABB)

- **Control Relay Requirements:**

Breaking Capacity	240Vac/ 5A
Contact Form	Normally Closed (NC)
Coil	12Vdc/ <0.5A
Suggested Model No.	HF13F-012-1Z1T

- **Backfeed Protection Wiring Diagram:**

Please refer to the diagram below to install the backfeed protection device between the AC input and the UPS.

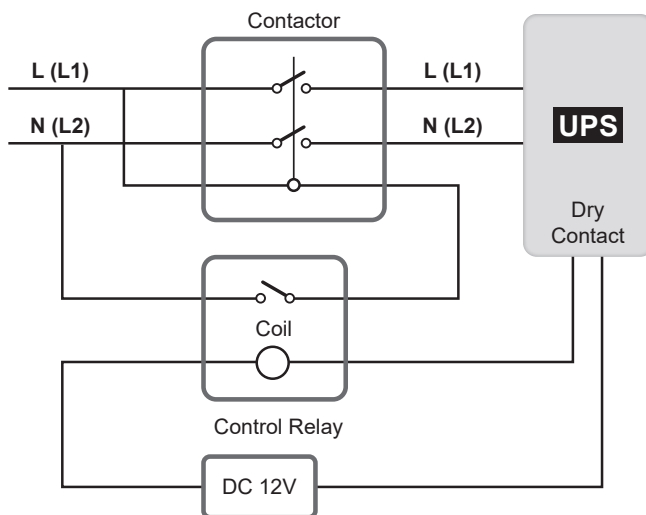

Chapter 8 : Operation

8.1 Start-up





NOTE :

1. Before start-up, ensure that the batteries are fully charged. Before using the UPS for the first time, please check the battery capacity and the charging settings. Make sure that you charge the batteries until the battery capacity percentage shown on the UPS's LCD is 100% ().
2. The configurable internal battery string quantity ranges from 16 to 22. Please make sure that the actual quantity of battery strings are the same as that configured on the LCD. Set up the corresponding charge current based on the total battery amp-hour.
3. If the UPS connects to an inductive load, the inrush current (initial surge current) may restart the inverter. To avoid this situation, please turn on the inductive load in bypass mode before starting up the inverter.

• Start-up with AC Input

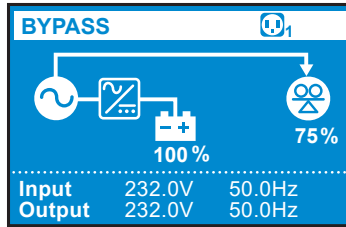
- 1 Verify if the UPS's input cord meets with N, L & G of the wall socket and the utility AC power works normally.
- 2 Switch on the input protective device (see **Figure 7-1**) installed between the UPS and the utility AC power. After that, the UPS will enter into the **Initial Setting Screen** (please refer to **9.1 Initial Setting Screen** for more information).
- 3 Press and hold the **ON/ OFF** button () for 3 seconds to start up the UPS. Release the button after you hear one beep and the UPS will start up. After the UPS performs self-diagnosis, the UPS will run in **ON-LINE** mode.



Press and hold the button  for 3 seconds and release it after you hear one beep.

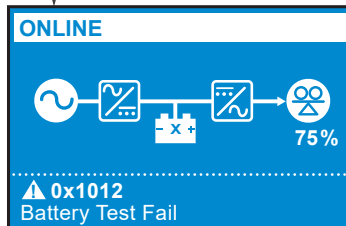
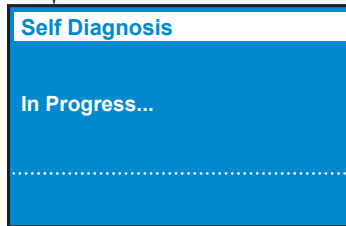

④ Once the UPS runs normally, switch on the output protective device (see **Figure 7-1**) installed between the UPS and the loads.

● **Start-up with Battery (Cold-start)**

① Please check the '+' and '-' poles of the batteries and ensure that wiring is correct.

② Turn on the battery breaker.

③ When there is no AC input, press and hold the **ON/ OFF** button () for 3 seconds to start up the UPS. Release the button after you hear one beep and the UPS will start up. After the UPS performs self-diagnosis, the UPS will run in **BATTERY** mode.

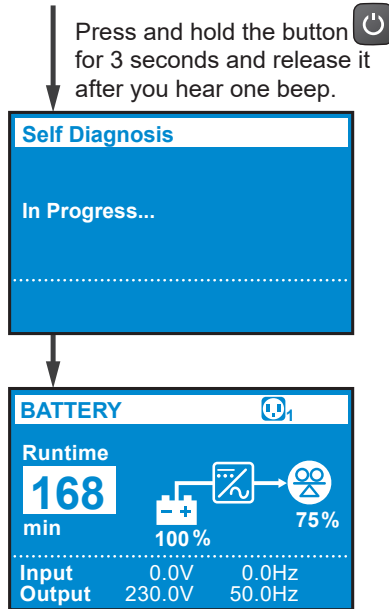





- ④ Once the UPS runs normally, switch on the output protective device (see **Figure 7-1**) installed between the UPS and the loads.



NOTE :

To prevent the UPS from activating the overload protection mechanism during start-up process, please turn on the high-power loads first and then low-power loads.

8.2 Turn-off

- ① Make sure all of the loads connected to the UPS are off.
- ② (1) Press and hold the **ON/ OFF** button () for 3 seconds, (2) release it after you hear one beep, (3) use the Scrolling UP or Down button ( / ) to select 'Yes', and (4) press the Enter button () to confirm your selection.
- ③ Switch off the input protective device (see **Figure 7-1**) and output protective device (see **Figure 7-1**).
- ④ After the LCD backlight goes dim and the fans stop completely, switch off the battery breaker to ensure that there is no remaining battery power.

8.3 Operation Mode

- **Standby Mode**

After the UPS is connected to the utility AC power, it will supply power to the UPS and the batteries will be charged.

- **Online Mode**

In on-line mode, the connected loads are supplied by the inverter, which derives its power from the utility AC power, and the UPS charges the batteries and provides power protection to its connected loads.

- **Bypass Mode**

In bypass mode, the critical loads are directly supplied by the utility AC power and the batteries are charged. The default setting of the UPS is set in **BYPASS** mode.

- **Battery Mode**

When the UPS is operating during a power outage, the batteries provide DC power, which maintains inverter operation to supply power to the critical loads.

You can install the UPSentry 2012 software (please download from <http://www.deltapowersolutions.com/en/mcis/software-center.php>) or install the Mini SNMP IPv6 card (optional) or the Mini MODBUS card (optional) to monitor and estimate the battery remaining capacity. For more information about the Mini SNMP IPv6 card (optional) or the Mini MODBUS card (optional), please refer to its user manual.

- **ECO Mode**

In ECO mode, when the utility input voltage and frequency are within the range of rating voltage $\pm 10\%$ and rating frequency $\pm 3\text{Hz}$, the loads are supplied by the utility AC power; if out of the range, the loads are supplied by the inverter.

- **Frequency Conversion Mode**

In Frequency Conversion mode, the UPS output frequency is manually set up. The system will disable the bypass function and there is no bypass output.

Chapter 9 : LCD Display & Settings



NOTE:

1. Please refer to **Chapter 3: Operation Panel** to learn how to operate the operation panel and understand every icon/ diagram definition.
2. Each of the display diagrams shown in this chapter is for reference only. Actual display depends on the operation of the UPS.

The following flow chart helps you to understand how to navigate each display screen.

9.1 Initial Setting Screen

When the UPS is powered on at first time, the LCD display will enter into the **Initial Setting Screen** and you can modify language, output voltage, battery parameters based on actual needs during initial setup. The default settings of language, output voltage, and battery parameters may vary according to different models. Press the  button to continue if there is no special requirement. After you configure the **Language, Date & Time, Output Setting, External Battery Type** and **External Battery Capacity** settings, the LCD display will move to the **Main Screen** that shows the current operation mode.

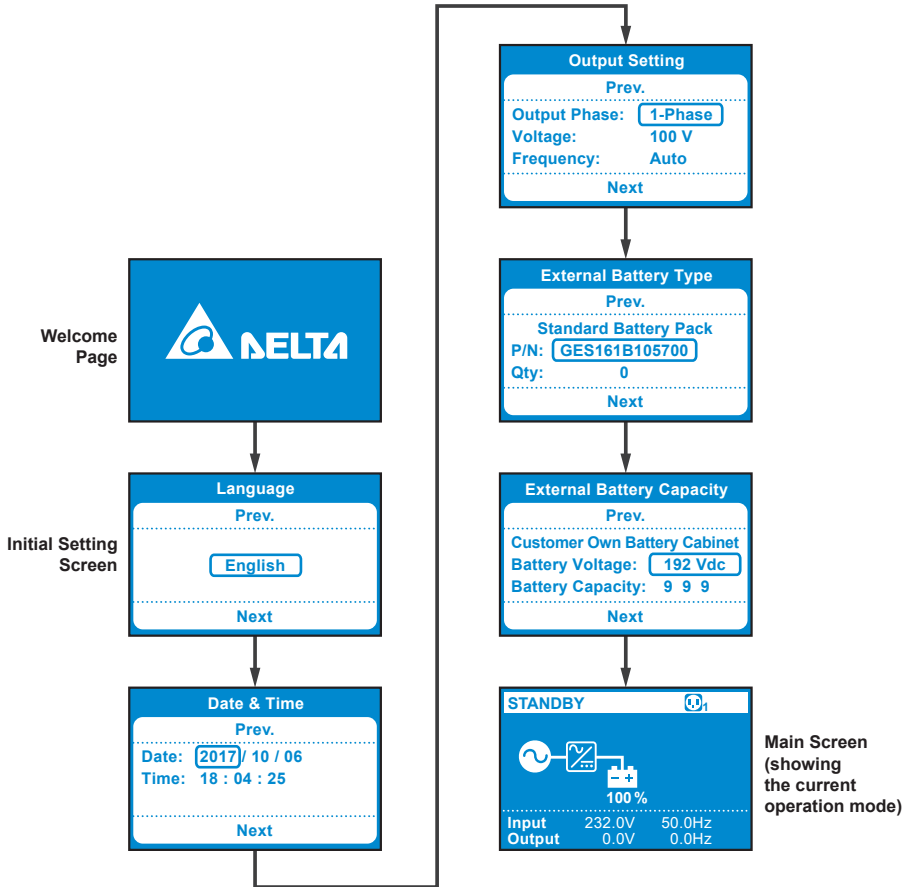

The **Initial Setting Screen** will no longer appear after initial configuration. Next time, when the UPS is powered on, the LCD display will show **DELTA** welcome page for 3 seconds and then directly go to the **Main Screen** that shows the current operation mode.

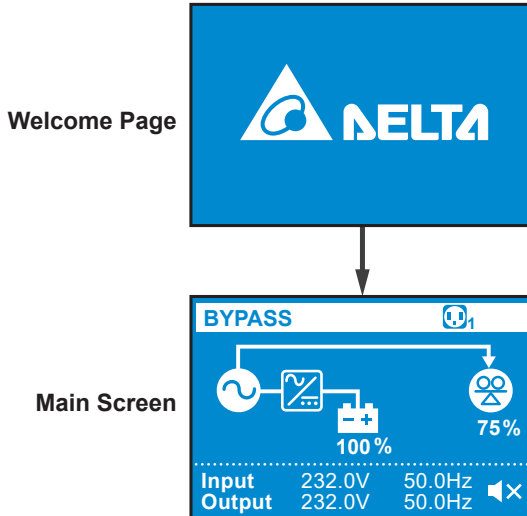

9.2 Main Menu



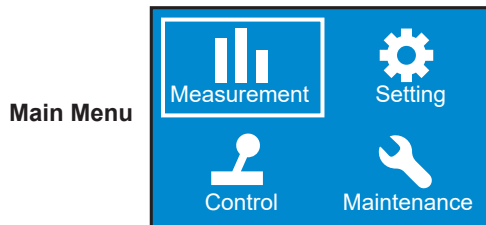







In the **Main Screen**, press the button  for 0.1 second to enter into the **Main Menu**. You can set up relevant items here.



NOTE:

Please note that only qualified service personnel can perform setup actions.

For setup procedures, please refer to the following:

- 1 In the **Main Menu**, select the item you want to configure, press the **ENTER** button  for 0.1 second and the UPS will enter into the setup mode.
- 2 Press the button  for 0.1 second or press the button  for 0.1 second to navigate the setting items.
- 3 Press the button  for 0.1 second to choose the parameter that you want to change, and the parameter will flash.
- 4 Press the button  for 0.1 second or press the button  for 0.1 second to increase or decrease the parameter value. If either of the buttons is pressed for over 2 seconds, the LCD will automatically switch between the selectable values every 0.2 second until either of the buttons is released or the number reaches its highest or lowest value.
- 5 Press the button  to confirm your parameter setup or press the button  to go back to the previous status.
- 6 After that, press the button  for 0.1 second or press the button  for 0.1 second to move to the previous or the next setting item.
- 7 In setup mode, press the  button and the LCD will exit from the setup mode.
- 8 In setup mode, if you don't press any button for more than 5 minutes, the LCD will exit from the setup mode and go back to the original display automatically.

Please refer to the **Menu Tree** below for all setting options.

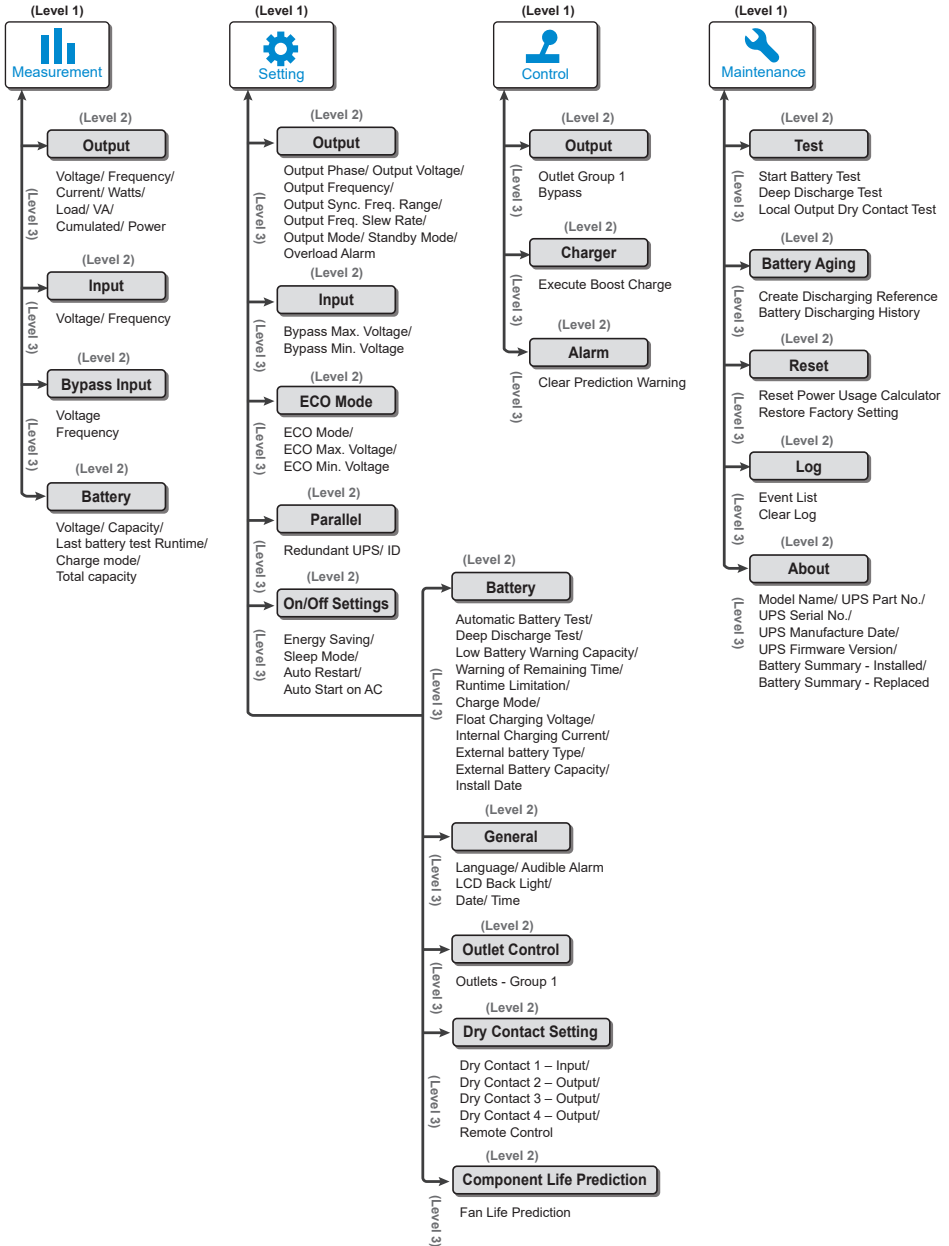



(Figure 9-1: Menu Tree)

9.2.1 Measurement Menu

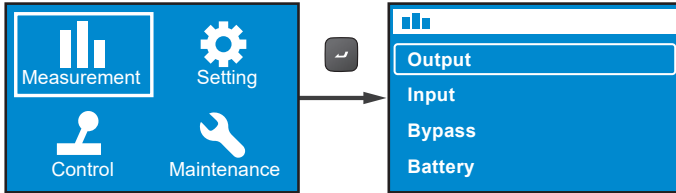
In **Main Menu**, after selecting  , press the button  to enter into the **Measurement Menu**. The **Measurement Menu** displays the UPS's status readings, such as **Output**, **Input**, **Bypass** and **Battery** information.



9.2.2 Setting Menu

In **Main Menu**, after selecting  , press the button  to enter into the **Setting Menu**.

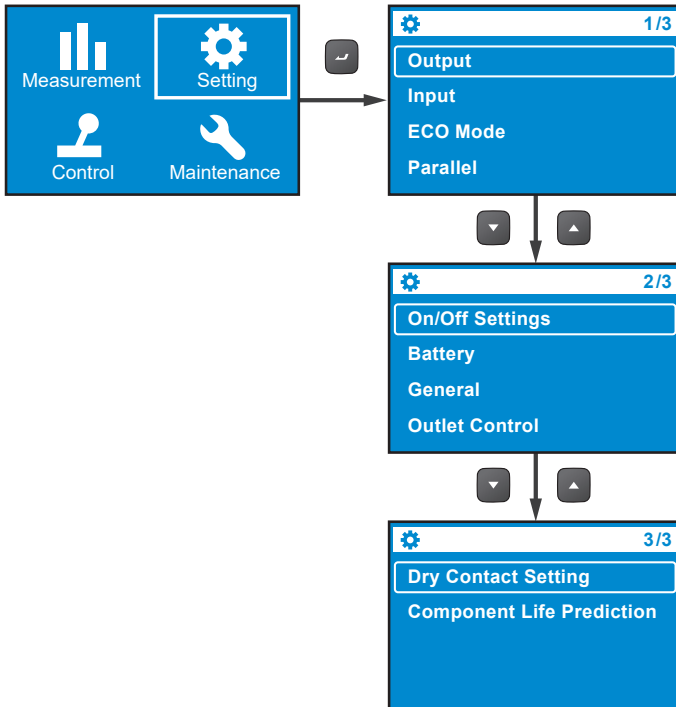

You can choose the setup items such as **Output, Input, ECO Mode, On/ Off Settings, Battery, General, Outlet Control, Dry Contact Setting** and **Component Life Prediction** to set up relevant settings. For more information about the **Setting Menu**, please refer to the tables below for each setup item's relevant default value and selectable value.

- **Output**

Setup Items	Selectable Value	Default
Output Phase	1-phase	1-phase
Output Voltage	200V, 208V, 220V, 230V, 240V	208V for suffix B8 model 230V for suffix 35 model
Output Frequency	Auto* / Converter-50Hz** / Converter-60Hz**	Auto
Output Sync. Freq. Range	±0.5/ 1/ 3/ 5Hz	±3Hz
Output Freq. Slew Rate	0.5/ 1/ 2/ 3/ 4 Hz/ sec.	1 Hz/sec.
Output Mode	Industrial/ IT	IT
Standby Mode	No output/ Bypass output	Bypass output
Overload Alarm	30-105% (one step: 5%)	105%



NOTE :

- * When the **Output Frequency** is set as **Auto**, the output frequency will vary according to the bypass frequency. If the bypass frequency is $\geq 55\text{Hz}$, the **Free_Run_Frequency/ Cold_Start_Frequency** will be set as 60Hz.
If the bypass frequency is $< 55\text{Hz}$, the **Free_Run_Frequency/ Cold_Start_Frequency** will be set as 50Hz.
- When the **Output Frequency** is set as **Auto** and the **Bypass Output** under the **Standby Mode** item is set as **Enable**, the bypass output range will be the same as the **Output Sync. Freq. Range**.
- ** When the **Output Frequency** is set as **Converter-50Hz/ Converter-60Hz**, the UPS will enter into **Frequency Conversion** mode and the bypass output will become **Disable**.

- **Input**

Setup Item	Selectable Value	Default Value
Bypass Max. Voltage	+10/ 15/ 20%	+15%
Bypass Min. Voltage	-10/ 15/ 20/ 25/ 30/ 35/ 40%	-20%

- **ECO Mode**

Setup Item	Selectable Value	Default Value
ECO Mode	Disable/ Enable	Disable
ECO Max. Voltage	5-15% (one step: 1%)	+10%
ECO Min. Voltage	5-15% (one step: 1%)	-10%



NOTE :

The setup items **ECO Max. Voltage** and **ECO Min. Voltage** will only be shown on the display when ECO Mode is enabled.

- **On/ Off Settings**

Setup Item	Selectable Value	Default Value
Energy Saving	Option 1*: Enable/ Disable Option 2: 1-15mins (one step: 1min) Option 3: 300W-1500W (one step: 100W)	Disable
Sleep Mode	Option 1: Enable/ Disable Option 2: 10-120mins (one step: 10mins)	10mins
Auto Restart	Enable/ Disable	Enable
Auto Start on AC	Enable/ Disable	Disable



NOTE :

In **Setting Menu**, the sub item **Option 1** under the item **Energy Saving** cannot be changed.

- Battery

Setup Item	Selectable Value	Default Value
Automatic Battery Test	No test/ Daily/ Weekly/ Biweekly/ Monthly	No test
Deep Discharge Test	20-90% (one step: 10%)	90%
Low Battery Warning Capacity	0-95% (one step: 5%)	10%
Warning of Remaining Time	0-60mins (one step: 1min)	2mins
Runtime Limitation	Disable/ 1/ 2/ 3.../ 240 (one step: 1min)	Disable
Charge Mode	2-stage/ 3-stage	2-stage
Float Charging Voltage	Auto/ Customize (2.20 - 2.35 V/ cell, one step: 0.01V)	Auto
Internal Charging Current	For 5K/ 6K: 1/ 2/ 3/ 4/ 5/ 6/ 7/ 8 For 8K/ 10K: 1.5/ 2/ 3/ 4/ 5/ 6	1A (5K/ 6K) 1.5A (8K/ 10K)
External Battery Type*	Standard battery pack/ Customer own batt. pack	
External Battery Capacity	Standard battery pack: Part Number Quantity Customer own batt. pack: Battery Voltage Capacity	
Install date	YYYY/ MM/ DD	

**NOTE :**

* When the **External Battery Type** is set as **Standard battery pack**, you need to configure the **Part Number** and the **Quantity** of the standard battery pack(s).

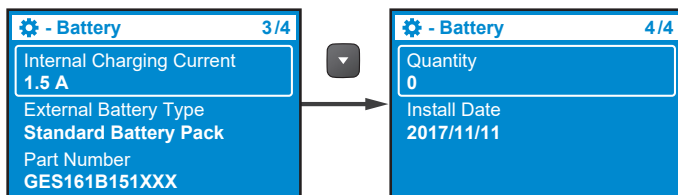

When the **External Battery Type** is set as **Customer own batt. pack**, the **Part Number** and **Quantity** will be changed accordingly to **Battery Voltage** and **Total Capacity**.

- **General**

Setup Item	Selectable Value	Default Value
Language	English/ 简体中文 / 繁體中文 /...	English
Audible Alarm	Enable/ Disable	Enable
LCD Back Light	Always On/ Auto Off	Auto off
Date	YYYY/MM/DD	
Time	HH:MM:SS	

- **Outlet Control**

Setup Item	Selectable Values- Level 2	Selectable Values- Level 3	Default Value
Outlets - Group 1	Output Reboot Duration	Disable/ 5/ 6/ .../ 300 seconds (one step: 1sec)	Disable
	Load Bank Runtime Limitation	Disable/ 1/ 2/ .../ 240mins (step: 1min)	Disable

• **Dry Contact Setting**

Setup items	Selectable value	Default value
Dry Contact 1 - Input	Option 1*: Disable/ ROO/ RPO/ Remote shutdown/ Forced bypass/ On generator Option 2: 0-999s (step: 1 sec) Option 3: Normal open/Normal close	Disable
Dry Contact 2 - Output	Disable/ On bat/ Low bat/ Bat fault/ Bypass/ UPS OK/ Load protected/ Load powered/ General alarm/ Overload alarm	On batt.
Dry Contact 3 - Output	Disable/ On bat/ Low bat/ Bat fault/ Bypass/ UPS OK/ Load protected/ Load powered/ General alarm/ Overload alarm	Low batt.
Dry Contact 4 - Output	Disable/ On bat/ Low bat/ Bat fault/ Bypass/ UPS OK/ Load protected/ Load powered/ General alarm/ Overload alarm	General alarm
Remote Control	Option 1: REPO/ ROO Option 2: Normally open/ Normally closed (For REPO) or delay time 0-999sec (step: 1 sec) Option 3: Normally open/ Normally closed (For ROO)	REPO/ NO





NOTE :

*For detailed information about option 1, please contact service personnel.

• **Component Life Prediction**

Setup Item	Selectable Value	Default Value
Fan Life Prediction	No/ Yes	No

9.2.3 Control Menu

In **Main Menu**, after selecting  , press the button  to enter into the **Control Menu**.

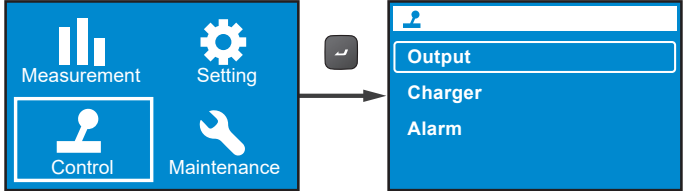

The **Control Menu** provides commands for enabling specific UPS functions. Please refer to the table below for the setup items and selectable values.

LEVEL 1	LEVEL 2	LEVEL 3	LEVEL 4	LEVEL 5
Control	Output	Outlet Group 1	Output Reboot Immediately	Yes/ No
			Output Reboot With Delay	Yes/ No
		Bypass* ¹	Go into Bypass	Yes/ No
			Go out of Bypass	Yes/ No
	Charger	Execute Boost Charge	Yes/ No	
	Alarm	Clear Prediction Warning* ²	Yes/ No	



 **NOTE:**

- *¹: The item **Bypass** will be hidden if you set the **Standby Mode** as **Bypass Output**. To set up **Bypass Output**, please go to  → **Output** → **Standby Mode** → **Bypass Output**.
- *²: The item **Delay Alarm Again** under **Control** → **Alarm** → **Clear Prediction Warning** can be set from 1 week to 52 weeks.

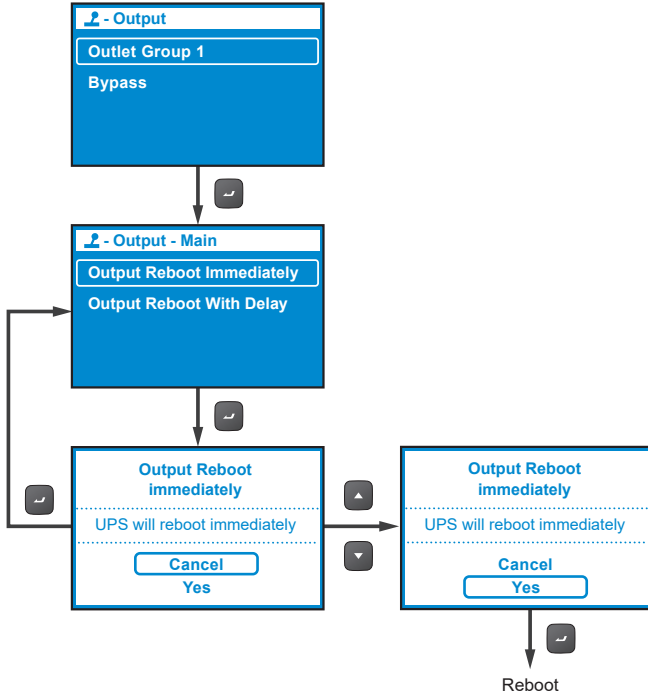
For example, if you need the UPS to reboot the output immediately, please go to  → **Output** → **Outlet Group 1** → **Output Reboot Immediately** → **Yes**.



9.2.4 Maintenance Menu

In **Main Menu**, after selecting  , press the button  to enter into the **Maintenance Menu**.

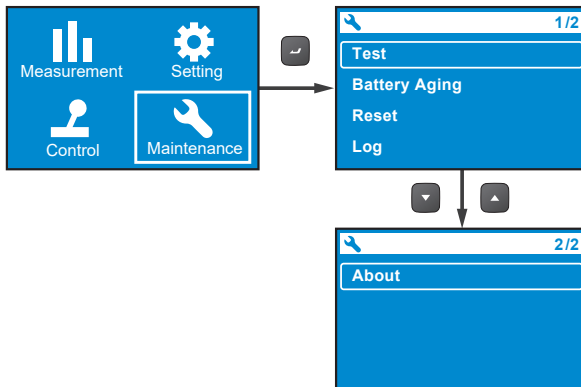

The **Maintenance Menu** provides commands for enabling UPS maintenance functions. It also provides event logs and UPS identification. Please refer to the table below for the setup items and selectable values.

LEVEL 1	LEVEL 2	LEVEL 3	LEVEL 4	LEVEL 5	
Maintenance	Test	Start Battery Test	Test in Progress...	Test Result: Pass	
				Test Result: Fail	
				Test Result: Not Finished	
		Deep Discharge Test	Test in Progress...	Test Result: Pass	
				Test Result: Fail	
				Test Result: Not Finished	
		Local Output Dry Contact Test	Dry Contact 1	Dry Contact 1 In Progress...	
			Dry Contact 2	Dry Contact 2 In Progress...	
			Dry Contact 3	Dry Contact 3 In Progress...	
			Dry Contact 4	Dry Contact 4 In Progress...	
		Battery Aging	Create Discharging Reference	Yes/ Cancel	
			Battery Discharging History	Item, Output power, Total discharging time	Date/ Time, Average load(W), Actual discharging time, Estimated remaining time, Total discharging time
	Reset	Reset Power Usage Calculator	Yes/ Cancel		
		Restore Factory Setting	Yes/ Cancel		

LEVEL 1	LEVEL 2	LEVEL 3	LEVEL 4	LEVEL 5
Maintenance	Log	Event List	Description, Event code YYYY/MM/DD HH:MM:SS	Error Description
		Clear Log	Yes/Cancel	
	About	Model Name: RT-5K		
		UPS - Part No. UPS502R2RT0B035		
		UPS - Serial No. 1BA0150001		
		UPS - Manufacture Date YYYY-MM		
		PS Firmware – Version 06AR004		
		Battery Summary: Installed YYYY/MM/ DD Replace YYYY/MM/ DD		

For example, if you need to execute a battery test, please go to **Test** → **Start Battery Test** → **Test In Progress...** → **Test Result: Pass (or Fail)**.

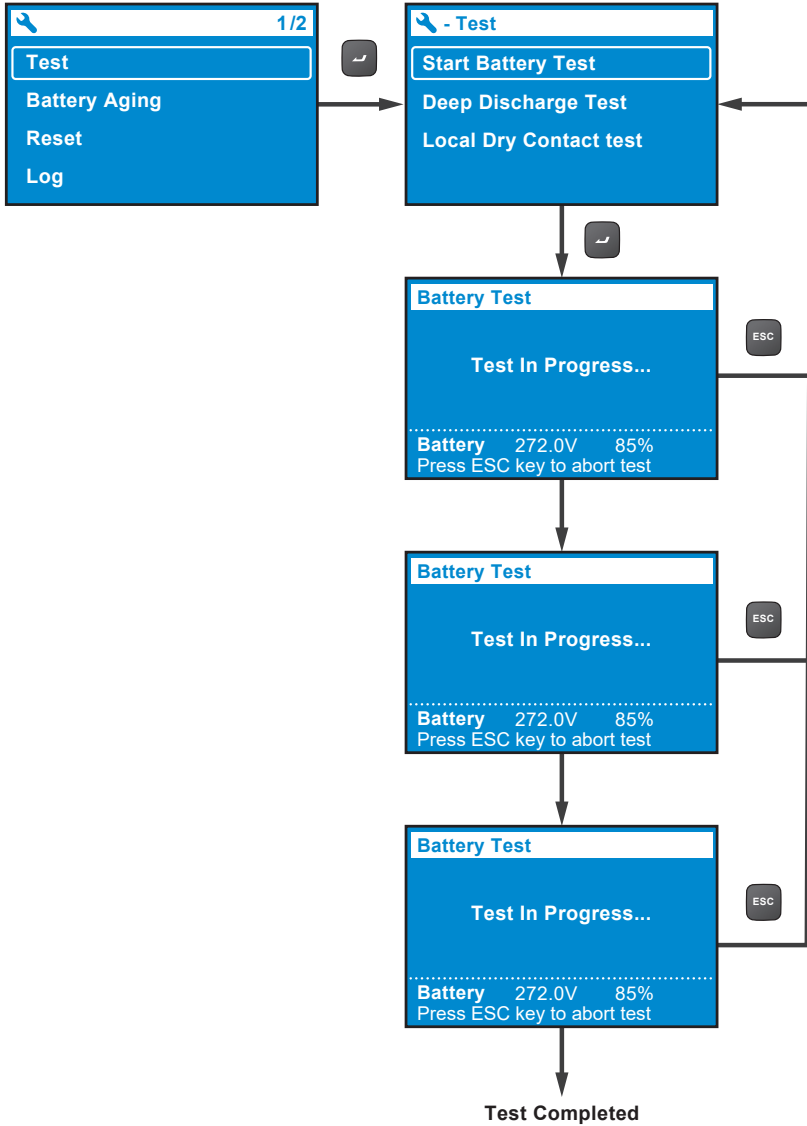

Once the test is completed, the test result will be shown as follows.

- A. Test Result_ Fail: The alarm icon will show in the left bottom of the LCD display.
- B. Tests Result_ Pass: No alarm icon occurs, and the UPS runs normally.

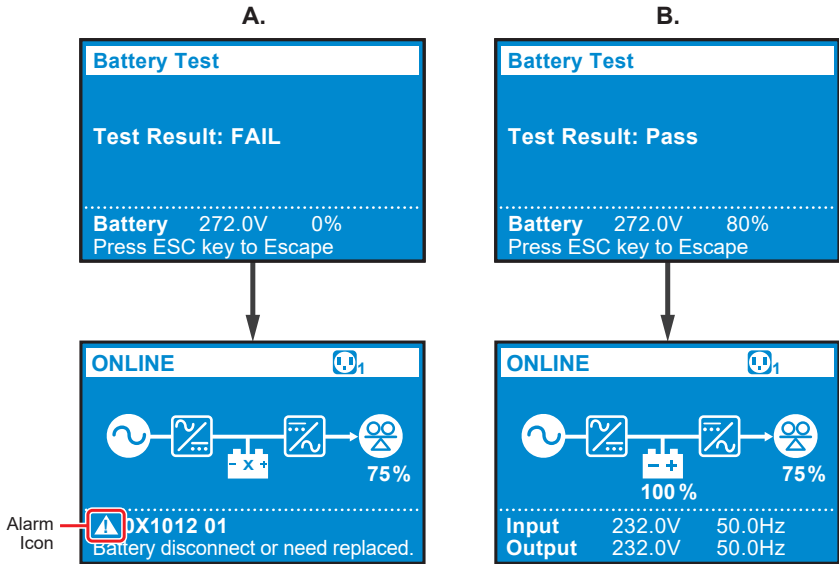

Chapter 10 : Optional Accessories

There are several optional accessories available for this RT series UPS. Please refer to the table below for the optional accessories and their functions.

No.	Item	Function
1	Dust Filter(s)	Prevent(s) dust from entering into the UPS to ensure UPS reliability and to prolong product life.
2	Mini SNMP IPv6 Card	Monitors and controls the status of the UPS via a network system.
3	Mini Relay I/O Card	Increases the quantity of dry contacts.
4	Mini MODBUS Card	Lets the UPS have MODBUS communication function.
5	External Battery Pack Cable Extension Kit (includes 2 annular terminals and 2 butt joint connectors)	Use the external battery pack cable extension kit to extend its range.
6	Delta External Battery Pack	Provides external batteries to let the UPS continue supplying power to its connected loads when a power outage occurs.
7	Rail Kit	Fixes the UPS in a rack cabinet firmly.



NOTE :

1. For detailed installation and operation of any accessory mentioned above, please refer to the **Quick Guide, User Guide, or Installation & Operation Guide** included in the package of the relevant optional accessory.
2. If you want to buy any accessory mentioned above, please contact your local dealer or customer service.

Chapter 11 : Troubleshooting

- When a problem occurs, please check if following situations exist before contacting Delta service personnel:
 - Is the main input voltage present?
- Please have the following information ready if you would like to contact the Delta service personnel:
 - Unit information including model, serial number, etc.
 - An exact description of the problem. The more detailed description of the problem, the better.
- When you see the following problems occur, please refer to the solutions shown below.

Error Code	Alarm Message	Possible Cause	Solution
0x61C1	Input Fuse Open	The input fuse is melted or the input relay is open.	Please contact service personnel.
0X60C0	PFC Soft Start Fail	The UPS has an internal fault.	Please contact service personnel.
0X6200	DC Bus Over Shutdown	<ol style="list-style-type: none"> The output has capacitive or inductive loads. The UPS has an internal fault. 	<ol style="list-style-type: none"> Remove the capacitive or inductive loads. Please contact service personnel.
0X62A0	DC Bus Under Shutdown	The UPS has an internal fault.	Please contact service personnel.
0X62C0	DC Bus Under Shutdown	The UPS has an internal fault.	Please contact service personnel.
0x1200	INV Volt Abnormal	The UPS has an internal fault.	Please contact service personnel.

Error Code	Alarm Message	Possible Cause	Solution
0x1101	Output Overload Shutdown	The UPS is over-loaded.	Check the power consumption of the loads, and remove the unnecessary loads.
0xA000	Charger Fault	The UPS has an internal fault.	Please contact service personnel.
0x8106	INV IGBT Over Heat Shutdown	<ol style="list-style-type: none"> 1. The vents are blocked. 2. The UPS has an internal fault. 	<ol style="list-style-type: none"> 1. Check whether the vents are blocked. 2. Contact service personnel.
0X6100	PFC Over Heat Shutdown	<ol style="list-style-type: none"> 1. The vents are blocked. 2. The UPS has an internal fault. 	<ol style="list-style-type: none"> 1. Check whether the vents are blocked. 2. Contact service personnel.
0x1003	Battery Disconnected	<ol style="list-style-type: none"> 1. The UPS is not properly connected to the external battery pack(s). 2. The battery/ batteries is (are) damaged. 	<ol style="list-style-type: none"> 1. Check whether the UPS is properly connected to the external battery pack(s). 2. Contact service personnel.



NOTE :

If all possible causes are eliminated but the alarm still appears, please contact your local dealer or customer service.

Chapter 12 : Maintenance

12.1 UPS

- **UPS Cleaning**

Regularly clean the UPS, especially the slits and openings, to ensure that the air freely flows into the UPS to avoid overheating. If necessary, use an air-gun to clean the slits and openings to prevent any object from blocking or covering these areas.

- **UPS Regular Inspection**

Regularly check the UPS every half year and inspect:

1. Whether the UPS, LEDs, and alarm function are operating normally.
2. Whether battery voltage is normal. If battery voltage is too high or too low, find the root cause.

12.2 Batteries

The RT series UPS uses sealed lead-acid batteries. Though the typical battery life cycle is 3~5 years, the battery life depends on the temperature, usage, and charging/ discharging frequency. High temperature environments and high charging/ discharging frequency will quickly shorten the battery life. The UPS does not require user maintenance; however, the batteries should be checked periodically. Please follow the suggestions below to ensure a normal battery lifetime.

- Keep the usage temperature at 20°C ~ 25°C.
- Idle batteries must be fully recharged every three months if the UPS needs to be stored for an extended period of time. Please fully charge the batteries (internal and external) until the battery capacity percentage shown on the UPS's LCD is 100% ()



NOTE :

If the UPS's internal batteries need to be replaced, please contact qualified service personnel. During battery replacement, the loads connected to the UPS will not be protected if input power fails.

12.3 Fans

Higher temperatures shorten fan life. When the UPS is running, please periodically check if each fan works normally and make sure if the ventilation air can move freely around and through the UPS. If not, contact service personnel to replace the fans.



NOTE:

Please ask your local dealer or customer service for more maintenance information. Do not perform maintenance if you are not trained for it.

Appendix 1 : Technical Specifications

Model		RT-5K	RT-6K	RT-8K	RT-10K	
Power Rating		5kVA/5kW 5kVA/4.5kW*1	6kVA/6kW	8kVA/8kW	10kVA/10kW	
Waveform		Pure Sinewave				
Input	Nominal Voltage	200*1/208*1/220/230/240 Vac				
	Voltage Range	175 ~ 280Vac (100% load); 100 ~ 174Vac (50% ~ 100% load)				
	Frequency	50/60 Hz ± 10 Hz				
	Power Factor	0.99 (full load)				
	iTHD	< 3% (linear load)				
	Con- nection	Suffix: B8	NEMA L6-30P power cord (10 ft)	Terminal		
		Suffix: 35	Terminal			
Output	Power Factor	Unity*1				
	Voltage	200*1/208*1/220/230/240 Vac				
	Voltage Regulation	± 1% (linear load)				
	Frequency	50/60 Hz ± 0.05 Hz				
	vTHD	<2% (linear load)		<3% (linear load)		
	Overload Capacity	< 105%: continuous; 105% ~ 125%: 2 minutes; 125% ~ 150%: 30 seconds; >150%, 500 ms				
	Cress Factor	3:1				

Model			RT-5K	RT-6K	RT-8K	RT-10K
Output	Con- nection	Suffix: B8	NEMA L6-30 × 1 (load bank) 5K: NEMA L6-20 × 2, L6-30 × 1 6K: NEMA L6-20 × 2, L6-30 × 1, Terminal × 1		NEMA L6-30 × 1 (load bank) Terminal × 1, L6-20 × 2, L6-30 × 2	
		Suffix: 35	IEC C19 × 1 (load bank) Terminal × 1, C13 × 6, C19 × 2		IEC C19 × 1 (load bank) Terminal × 1, C13 × 6, C19 × 4	
Efficiency	Online Mode		Up to 95.5%			
	ECO Mode		Up to 99%			
Battery & Charger	Battery Voltage		192 Vdc		240 Vdc	
	Battery Type		12V/7Ah Sealed lead-acid battery		12V/9Ah Sealed lead-acid battery	
	Backup Time (100% load/ 75% load)		5.5/8.5 minutes (O/P PF 0.9) 5/7.5 minutes (O/P PF unity)	3/5.5 minutes	5/9 minutes	3.5/6 minutes
	Charging Current		1A (default)		1.5A (default)	
	Recharge Time		< 3 hours to 90%			
Audible Noise			48 dBA		50 dBA	
Display			LED indicators and LCD display			
Communication Interfaces			MINI Slot × 1, RS-232 Port × 1, USB Port × 1, REPO/ROO × 1, RS-485 Port × 1, Dry Contact × 4			
Physical	Dimensions (W × D × H)		440 × 665 × 176 mm 17.3 × 26.2 × 6.9 inch		440 × 750 × 218 mm 17.3 × 29.5 × 8.6 inch	
	Weight	Suffix: B8	55 kg (121.23 lb)	55 kg (121.23 lb)	86 kg (189.6 lb)	86 kg (189.6 lb)
		Suffix: 35	54 kg (119.1 lb)	54 kg (119.1 lb)	85.5 kg (188.5 lb)	85.5 kg (188.5 lb)

Model		RT-5K	RT-6K	RT-8K	RT-10K
Environment	Operating Altitude	0 ~ 3000 m (0 ~ 10000 ft); 0 ~ 1000 m (0 ~ 3300 ft) (without derating)			
	Operating Temperature	0°C ~ 40°C (32 ~ 104°F)			
	Storage Temperature	-15°C ~ 50°C (-59 ~ 122°F)			
	Relative Humidity	5% ~ 95% (non-condensing)			



NOTE:

- *1: For the suffix B8 model, the output power factor for 5kVA UPS is 0.9. However, when the output voltage is at 200V, the 5kVA UPS needs to be de-rated to 90% of its capacity.
- Please refer to the rating label for the safety rating.
- All specifications are subject to change without prior notice.

Appendix 2 : Warranty

Seller warrants this product, if used in accordance with all applicable instructions, to be free from original defects in material and workmanship within the warranty period. If the product has any failure problem within the warranty period, Seller will repair or replace the product at its sole discretion according to the failure situation.

This warranty does not apply to normal wear or to damage resulting from improper installation, operation, usage, maintenance or irresistible force (i.e. war, fire, natural disaster, etc.), and this warranty also expressly excludes all incidental and consequential damages.

Maintenance service for a fee is provided for any damage out of the warranty period. If any maintenance is required, please directly contact the supplier or Seller.



WARNING:

The individual user should take care to determine prior to use whether the environment and the load characteristic are suitable, adequate or safe for the installation and the usage of this product. The User Manual must be carefully followed. Seller makes no representation or warranty as to the suitability or fitness of this product for any specific application.

No. 501326760102
Version : V 1.2
Release Date : 2019_03_08

