

# DELPHI SERIES



## FEATURES

- High efficiency: 92% @ 12Vin, 3.3V/16A out
- Small size and low profile: (SMD) 33.0x 13.5x 8.8mm (1.30" x 0.53" x 0.35")
- Standard footprint
- Voltage and resistor-based trim
- Pre-bias startup
- Output voltage tracking
- No minimum load required
- Output voltage programmable from 0.75Vdc to 5.0Vdc via external resistor
- Fixed frequency operation (300KHz)
- Input UVLO, output OTP, OCP
- Remote ON/OFF (default: positive)
- Remote sense
- ISO 9001, TL 9000, ISO 14001, QS 9000, OHSAS 18001 certified manufacturing facility
- UL/cUL 60950 (US & Canada) Recognized, and TUV (EN60950) certified.
- CE mark meets 73/23/EEC and 93/68/EEC directives

## Delphi DNL, Non-Isolated Point of Load DC/DC Power Modules: 8.3-14Vin, 0.75-5.0V/16A out

The Delphi series DNL, 8.3~14V input, single output, non-isolated point of load DC/DC converters are the latest offering from a world leader in power systems technology and manufacturing — Delta Electronics, Inc. The DNL series provides a programmable output voltage from 0.75V to 5.0V through an external trimming resistor. The DNL converters have flexible and programmable tracking and sequencing features to enable a variety of sequencing and tracking between several point of load power modules. This product family is available in a surface mount or SIP package and provides up to 16A of output current in an industry standard footprint and pinout. With creative design technology and optimization of component placement, these converters possess outstanding electrical and thermal performance and extremely high reliability under highly stressful operating conditions.

## OPTIONS

- Negative On/Off logic
- Tracking feature
- SMD package

## APPLICATIONS

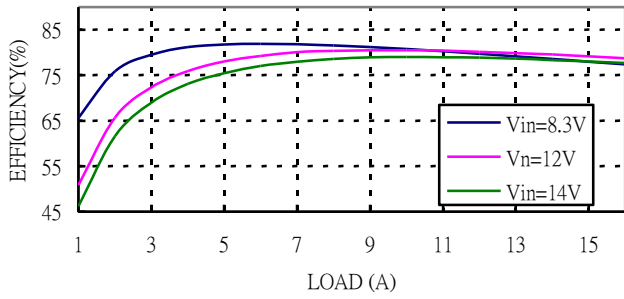
- Telecom / DataCom
- Distributed power architectures
- Servers and workstations
- LAN / WAN applications
- Data processing applications

# TECHNICAL SPECIFICATIONS

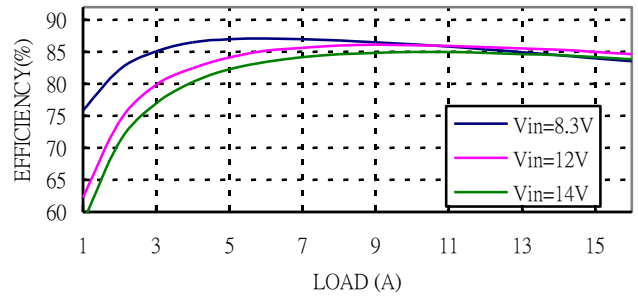
T<sub>A</sub> = 25°C, airflow rate = 300 LFM, V<sub>in</sub> = 8.3Vdc and 14Vdc, nominal V<sub>out</sub> unless otherwise noted.

PARAMETER	NOTES and CONDITIONS	DNL10S0A0S16NFD			
		Min.	Typ.	Max.	Units
<b>ABSOLUTE MAXIMUM RATINGS</b>					
Input Voltage (Continuous)		0		15	Vdc
Tracking Voltage		0		V <sub>in,max</sub>	Vdc
Operating Temperature		-40		85	°C
Storage Temperature		-55		125	°C
<b>INPUT CHARACTERISTICS</b>					
Operating Input Voltage	V <sub>o,set</sub> ≤ 3.63Vdc	8.3	12	14	V
	V <sub>o,set</sub> > 3.63Vdc	8.3	12	13.2	V
Input Under-Voltage Lockout					
Turn-On Voltage Threshold			7.9		V
Turn-Off Voltage Threshold			7.8		V
Maximum Input Current	V <sub>in</sub> =V <sub>in,min</sub> to V <sub>in,max</sub> , I <sub>o</sub> =I <sub>o,max</sub>			11.2	A
No-Load Input Current			100		mA
Off Converter Input Current			2		mA
Inrush Transient	V <sub>in</sub> = V <sub>in,min</sub> to V <sub>in,max</sub> , I <sub>o</sub> =I <sub>o,min</sub> to I <sub>o,max</sub>			0.4	A <sup>2</sup> S
Recommended Input Fuse				15	A
<b>OUTPUT CHARACTERISTICS</b>					
Output Voltage Set Point	V <sub>in</sub> =12V, I <sub>o</sub> =I <sub>o,max</sub>	-2.0	V <sub>o,set</sub>	+2.0	% V <sub>o,set</sub>
Output Voltage Adjustable Range		0.7525		5	V
Output Voltage Regulation					
Over Line	V <sub>in</sub> =V <sub>in,min</sub> to V <sub>in,max</sub>		0.3		% V <sub>o,set</sub>
Over Load	I <sub>o</sub> =I <sub>o,min</sub> to I <sub>o,max</sub>		0.4		% V <sub>o,set</sub>
Over Temperature	T <sub>a</sub> = -40°C to 85°C		0.4		% V <sub>o,set</sub>
Total Output Voltage Range	Over sample load, line and temperature	-2.5		+3.5	% V <sub>o,set</sub>
Output Voltage Ripple and Noise	5Hz to 20MHz bandwidth				
Peak-to-Peak	V <sub>in</sub> =min to max, I <sub>o</sub> =min to max 1μF ceramic, 10μF Tan		50	75	mV
RMS	V <sub>in</sub> =min to max, I <sub>o</sub> =min to max 1μF ceramic, 10μF Tan		15	30	mV
Output Current Range		0		16	A
Output Voltage Over-shoot at Start-up	V <sub>out</sub> =3.3V			1	% V <sub>o,set</sub>
Output DC Current-Limit Inception			180		% I <sub>o</sub>
Output Short-Circuit Current (Hiccup mode)	I <sub>o,s/c</sub>		3		Adc
<b>DYNAMIC CHARACTERISTICS</b>					
Dynamic Load Response	10μF Tan & 1μF ceramic load cap, 2.5A/μs, V <sub>in</sub> =12V				
Positive Step Change in Output Current	50% I <sub>o</sub> , max to 100% I <sub>o</sub> , max		200		mVpk
Negative Step Change in Output Current	100% I <sub>o</sub> , max to 50% I <sub>o</sub> , max		200		mVpk
Settling Time to 10% of Peak Deviation			25		μs
Turn-On Transient	I <sub>o</sub> =I <sub>o,max</sub>				
Start-Up Time, From On/Off Control	V <sub>on/off</sub> , V <sub>o</sub> =10% of V <sub>o,set</sub>		5		ms
Start-Up Time, From Input	V <sub>in</sub> =V <sub>in,min</sub> , V <sub>o</sub> =10% of V <sub>o,set</sub>		5		ms
Output Voltage Rise Time	Time for V <sub>o</sub> to rise from 10% to 90% of V <sub>o,set</sub>		4	6	ms
Output Capacitive Load	Full load; ESR ≥ 1mΩ			1000	μF
	Full load; ESR ≥ 10mΩ, V <sub>in</sub> <9.0V			3500	μF
	Full load; ESR ≥ 10mΩ, V <sub>in</sub> ≥ 9.0V			5000	μF
<b>EFFICIENCY</b>					
V <sub>o</sub> =0.75V	V <sub>in</sub> =12V, I <sub>o</sub> =I <sub>o,max</sub>		79.0		%
V <sub>o</sub> =1.2V	V <sub>in</sub> =12V, I <sub>o</sub> =I <sub>o,max</sub>		85.0		%
V <sub>o</sub> =1.5V	V <sub>in</sub> =12V, I <sub>o</sub> =I <sub>o,max</sub>		87.0		%
V <sub>o</sub> =1.8V	V <sub>in</sub> =12V, I <sub>o</sub> =I <sub>o,max</sub>		89.0		%
V <sub>o</sub> =2.5V	V <sub>in</sub> =12V, I <sub>o</sub> =I <sub>o,max</sub>		91.0		%
V <sub>o</sub> =3.3V	V <sub>in</sub> =12V, I <sub>o</sub> =I <sub>o,max</sub>		92.0		%
V <sub>o</sub> =5.0V	V <sub>in</sub> =12V, I <sub>o</sub> =I <sub>o,max</sub>		94.0		%
<b>FEATURE CHARACTERISTICS</b>					
Switching Frequency			300		kHz
ON/OFF Control, (Negative logic)					
Logic Low Voltage	Module On, V <sub>on/off</sub>	-0.2		0.3	V
Logic High Voltage	Module Off, V <sub>on/off</sub>	2.5		V <sub>in,max</sub>	V
Logic Low Current	Module On, I <sub>on/off</sub>			10	μA
Logic High Current	Module Off, I <sub>on/off</sub>		0.2	1	mA
ON/OFF Control, (Positive Logic)					
Logic High Voltage	Module On, V <sub>on/off</sub>			V <sub>in,max</sub>	V
Logic Low Voltage	Module Off, V <sub>on/off</sub>	-0.2		0.3	V
Logic High Current	Module On, I <sub>on/off</sub>			10	μA
Logic Low Current	Module Off, I <sub>on/off</sub>		0.2	1	mA
Tracking Slew Rate Capability		0.1		2	V/msec
Tracking Delay Time	Delay from V <sub>in,min</sub> to application of tracking voltage	10			ms
Tracking Accuracy	Power-up, subject to 2V/mS		100	200	mV
	Power-down, subject to 1V/mS		200	400	mV
Remote Sense Range				0.1	V
<b>GENERAL SPECIFICATIONS</b>					
MTBF	I <sub>o</sub> =80%I <sub>o,max</sub> , T <sub>a</sub> =25°C		8.4		M hours
Weight			9		grams
Over-Temperature Shutdown	Refer to Figure 32 for the measuring point		130		°C

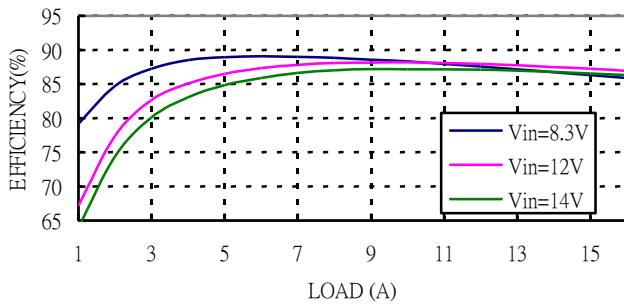
# ELECTRICAL CHARACTERISTICS CURVES



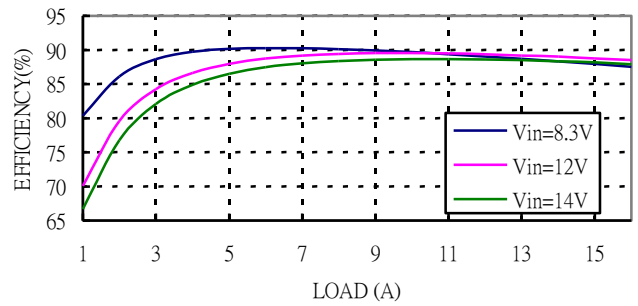
**Figure 1:** Converter efficiency vs. output current (0.75V output voltage)



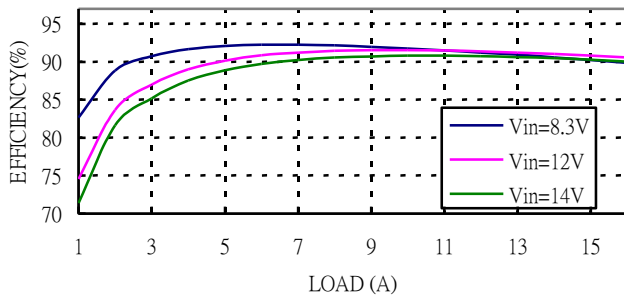
**Figure 2:** Converter efficiency vs. output current (1.2V output voltage)



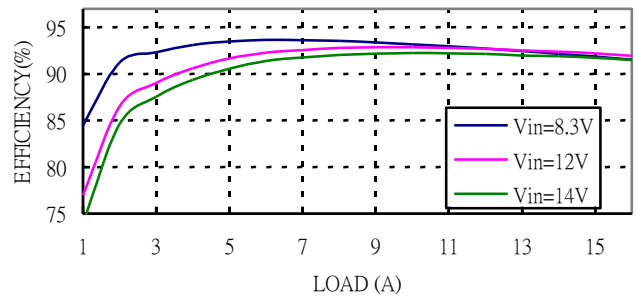
**Figure 3:** Converter efficiency vs. output current (1.5V output voltage)



**Figure 4:** Converter efficiency vs. output current (1.8V output voltage)



**Figure 5:** Converter efficiency vs. output current (2.5V output voltage)



**Figure 6:** Converter efficiency vs. output current (3.3V output voltage)



# ELECTRICAL CHARACTERISTICS CURVES

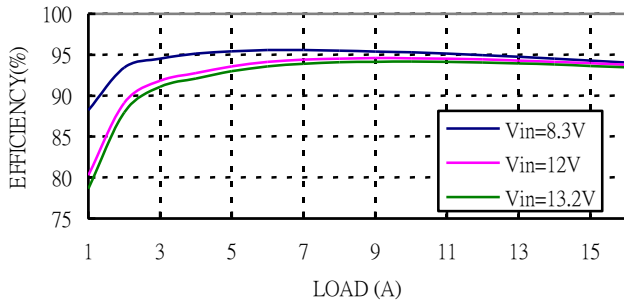


Figure 7: Converter efficiency vs. output current (5.0V output voltage)

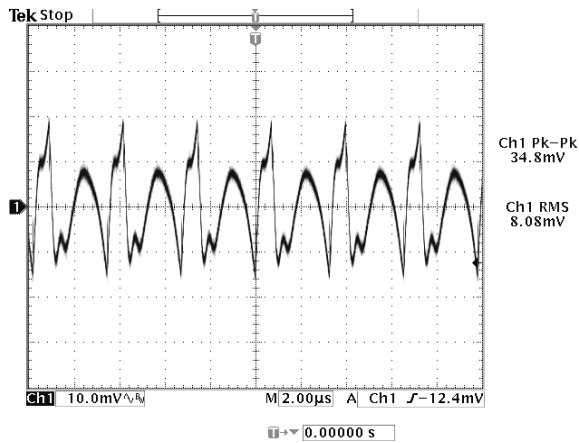


Figure 8: Output ripple & noise at 12Vin, 2.5V/16A out

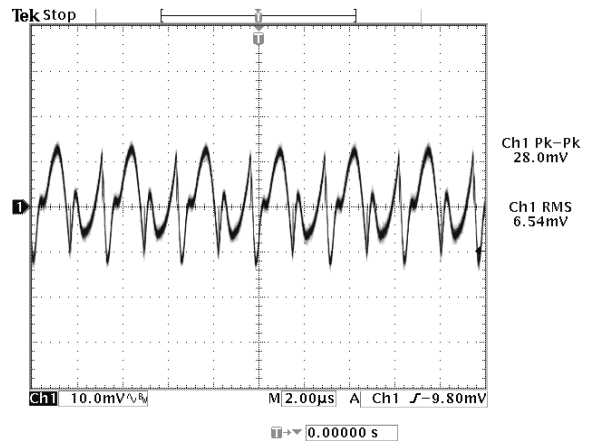


Figure 9: Output ripple & noise at 12Vin, 5.0V/16A out

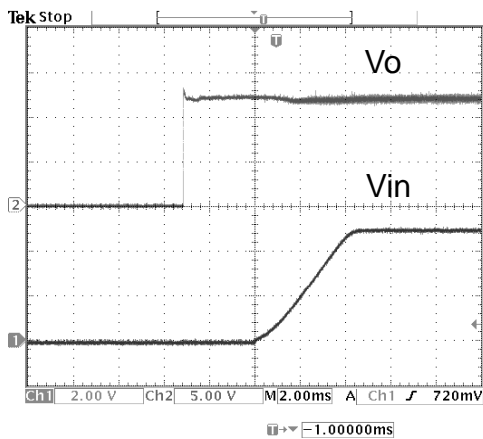


Figure 10: Turn on delay time at 12vin, 5.0V/16A out

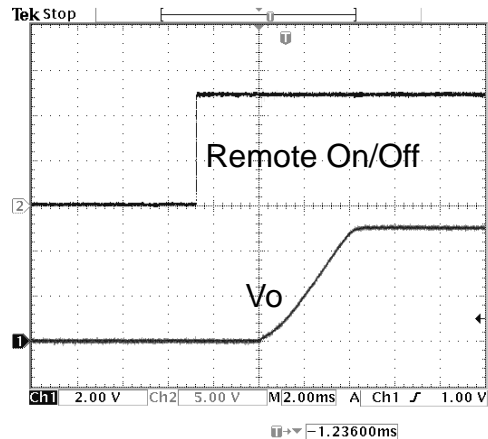
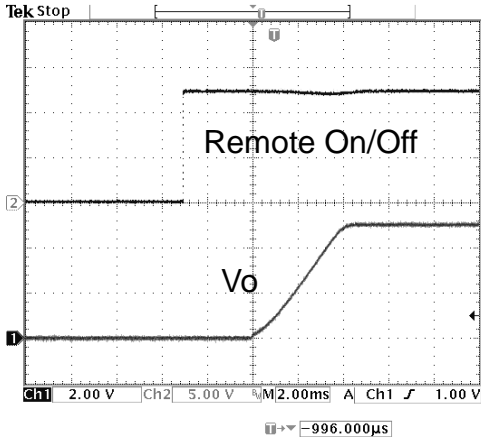
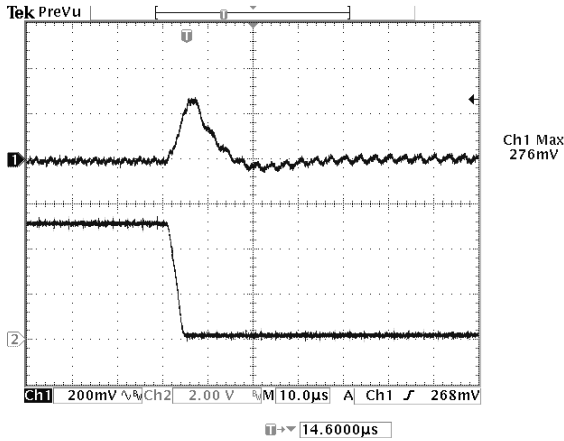


Figure 11: Turn on delay time at Remote On/Off, 5.0V/16A out

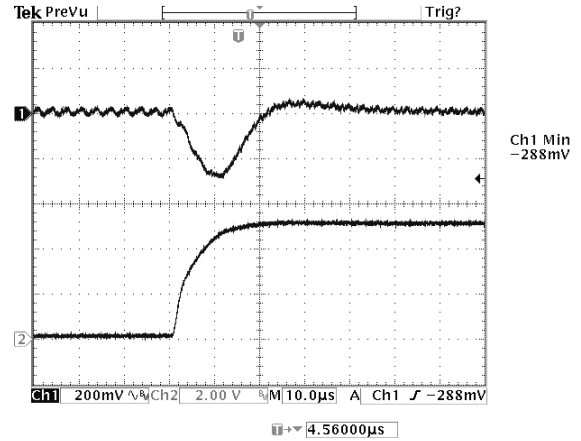
# ELECTRICAL CHARACTERISTICS CURVES



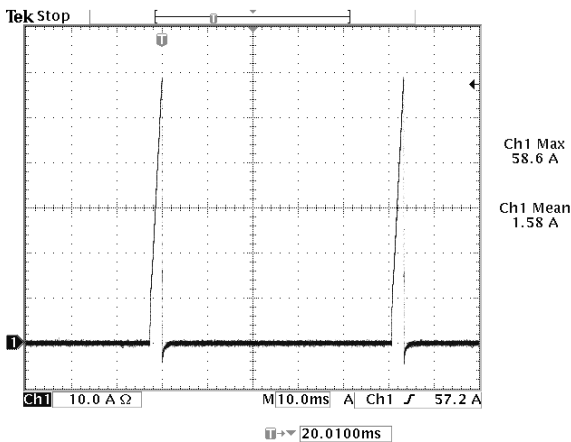
**Figure 12:** Turn on Using Remote On/Off with external capacitors ( $C_o = 5000 \mu F$ ), 5.0V/16A out



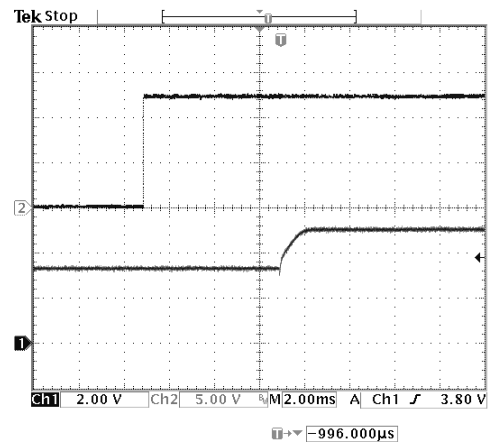
**Figure 13:** Typical transient response to step load change at  $2.5A/\mu S$  from 100% to 50% of  $I_o$ , max at 12Vin, 5.0V out ( $C_{out} = 1\mu F$  ceramic,  $10\mu F$  tantalum)



**Figure 14:** Typical transient response to step load change at  $2.5A/\mu S$  from 50% to 100% of  $I_o$ , max at 12Vin, 5.0V out ( $C_{out} = 1\mu F$  ceramic,  $10\mu F$  tantalum)

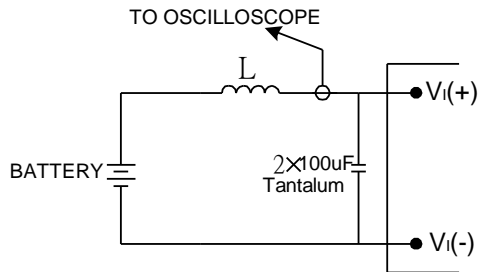


**Figure 15:** Output short circuit current 12Vin, 0.75Vout (10A/div)



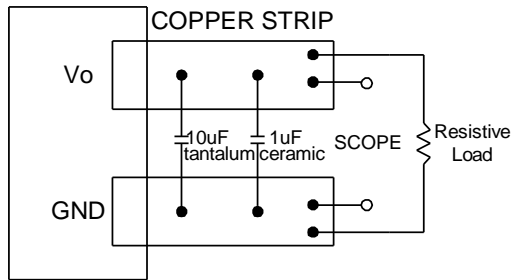
**Figure 16:** Turn on with Prebias 12Vin, 5V/0A out,  $V_{bias} = 3.3V_{dc}$

## TEST CONFIGURATIONS



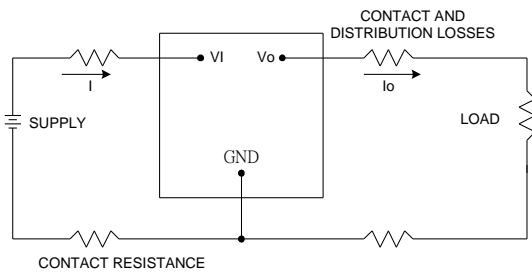
Note: Input reflected-ripple current is measured with a simulated source inductance. Current is measured at the input of the module.

**Figure 17:** Input reflected-ripple test setup



Note: Use a 10 $\mu$ F tantalum and 1 $\mu$ F capacitor. Scope measurement should be made using a BNC connector.

**Figure 18:** Peak-peak output noise and startup transient measurement test setup



**Figure 19:** Output voltage and efficiency measurement test setup

Note: All measurements are taken at the module terminals. When the module is not soldered (via socket), place Kelvin connections at module terminals to avoid measurement errors due to contact resistance.

$$\eta = \left( \frac{V_o \times I_o}{V_i \times I_i} \right) \times 100 \%$$

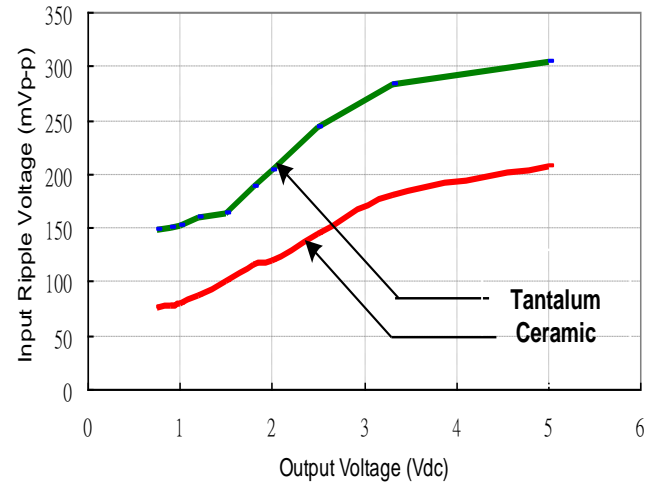
## DESIGN CONSIDERATIONS

### Input Source Impedance

To maintain low-noise and ripple at the input voltage, it is critical to use low ESR capacitors at the input to the module. Figure 20 shows the input ripple voltage (mVp-p) for various output models using 6x47  $\mu$ F low ESR tantalum capacitors (SANYO P/N:16TPB470M, 47 $\mu$ F/16V or equivalent) and 6x22  $\mu$ F very low ESR ceramic capacitors (TDK P/N:C3225X7S1C226MT, 22 $\mu$ F/16V or equivalent).

The input capacitance should be able to handle an AC ripple current of at least:

$$I_{rms} = I_{out} \sqrt{\frac{V_{out}}{V_{in}} \left( 1 - \frac{V_{out}}{V_{in}} \right)} \quad Arms$$



**Figure 20:** Input ripple voltage for various output models,  $I_o = 16A$  ( $C_{in} = 6 \times 47\mu F$  tantalum capacitors and  $6 \times 22\mu F$  ceramic capacitors at the input)

## DESIGN CONSIDERATIONS (CON.)

The power module should be connected to a low ac-impedance input source. Highly inductive source impedances can affect the stability of the module. An input capacitance must be placed close to the modules input pins to filter ripple current and ensure module stability in the presence of inductive traces that supply the input voltage to the module.

### Safety Considerations

For safety-agency approval the power module must be installed in compliance with the spacing and separation requirements of the end-use safety agency standards.

For the converter output to be considered meeting the requirements of safety extra-low voltage (SELV), the input must meet SELV requirements. The power module has extra-low voltage (ELV) outputs when all inputs are ELV.

The input to these units is to be provided with a maximum 15A of glass type fast-acting fuse in the ungrounded lead.

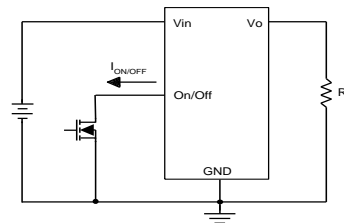
## FEATURES DESCRIPTIONS

### Remote On/Off

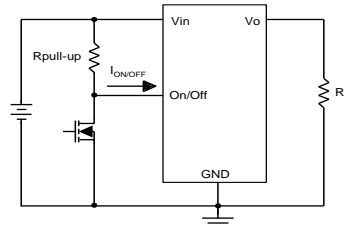
The DNL series power modules have an On/Off pin for remote On/Off operation. Both positive and negative On/Off logic options are available in the DNL series power modules.

For positive logic module, connect an open collector (NPN) transistor or open drain (N channel) MOSFET between the On/Off pin and the GND pin (see figure 21). Positive logic On/Off signal turns the module ON during the logic high and turns the module OFF during the logic low. When the positive On/Off function is not used, leave the pin floating or tie to  $V_{in}$  (module will be On).

For negative logic module, the On/Off pin is pulled high with an external pull-up resistor (see figure 22) Negative logic On/Off signal turns the module OFF during logic high and turns the module ON during logic low. If the negative On/Off function is not used, leave the pin floating or tie to GND. (module will be On)



**Figure 21:** Positive remote On/Off implementation



**Figure 22:** Negative remote On/Off implementation

### Over-Current Protection

To provide protection in an output over load fault condition, the unit is equipped with internal over-current protection. When the over-current protection is triggered, the unit enters hiccup mode. The units operate normally once the fault condition is removed.

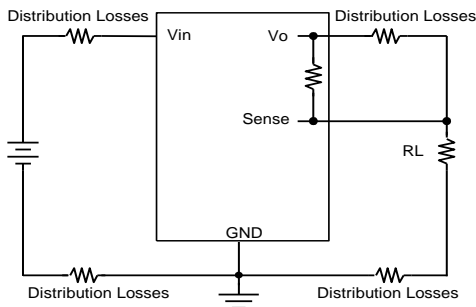
## FEATURES DESCRIPTIONS (CON.)

### Over-Temperature Protection

The over-temperature protection consists of circuitry that provides protection from thermal damage. If the temperature exceeds the over-temperature threshold the module will shut down. The module will try to restart after shutdown. If the over-temperature condition still exists during restart, the module will shut down again. This restart trial will continue until the temperature is within specification

### Remote Sense

The DNL provide  $V_o$  remote sensing to achieve proper regulation at the load points and reduce effects of distribution losses on output line. In the event of an open remote sense line, the module shall maintain local sense regulation through an internal resistor. The module shall correct for a total of 0.1V of loss. The remote sense line impedance shall be  $< 10\Omega$ .



**Figure 23:** Effective circuit configuration for remote sense operation

### Output Voltage Programming

The output voltage of the DNL can be programmed to any voltage between 0.75Vdc and 5.0Vdc by connecting one resistor (shown as  $R_{trim}$  in Figure 24) between the TRIM and GND pins of the module. Without this external resistor, the output voltage of the module is 0.7525 Vdc. To calculate the value of the resistor  $R_{trim}$  for a particular output voltage  $V_o$ , please use the following equation:

$$R_{trim} := \left( \frac{10500}{V_o - 0.7525} - 1000 \right) \cdot \Omega$$

$R_{trim}$  is the external resistor in  $\Omega$   
 $V_o$  is the desired output voltage

For example, to program the output voltage of the DNL module to 3.3Vdc,  $R_{trim}$  is calculated as follows:

$$R_{trim} := \left( \frac{10500}{2.5475} - 1000 \right) \cdot \Omega$$

$$R_{trim} = 3.122 \text{ k}\Omega$$

DNL can also be programmed by applying a voltage between the TRIM and GND pins (Figure 25). The following equation can be used to determine the value of  $V_{trim}$  needed for a desired output voltage  $V_o$ :

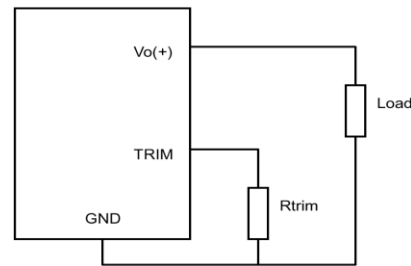
$$V_{trim} := 0.7 - [(V_o - 0.7525) \cdot 0.0667]$$

$V_{trim}$  is the external voltage in V  
 $V_o$  is the desired output voltage

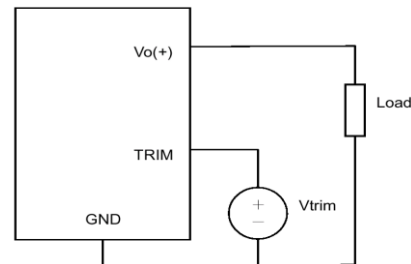
For example, to program the output voltage of a DNL module to 3.3 Vdc,  $V_{trim}$  is calculated as follows

$$V_{trim} := 0.7 - (2.5475 \cdot 0.0667)$$

$$V_{trim} = 0.530\text{V}$$



**Figure 24:** Circuit configuration for programming output voltage using an external resistor



**Figure 25:** Circuit Configuration for programming output voltage using external voltage source



## FEATURE DESCRIPTIONS (CON.)

Table 1 provides Rtrim values required for some common output voltages, while Table 2 provides values of external voltage source, Vtrim, for the same common output voltages. By using a 1% tolerance trim resistor, set point tolerance of  $\pm 2\%$  can be achieved as specified in the electrical specification.

**Table 1**

VO (V)	Rtrim (K $\Omega$ )
0.7525	Open
1.2	22.464
1.5	13.047
1.8	9.024
2.5	5.009
3.3	3.122
5.0	1.472

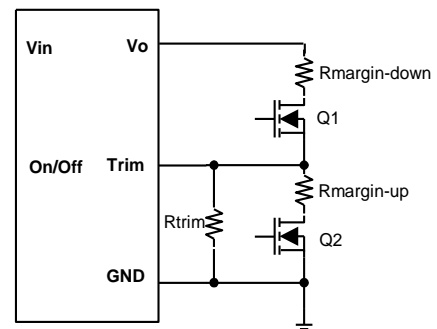
**Table 2**

VO (V)	Vtrim (V)
0.7525	Open
1.2	0.670
1.5	0.650
1.8	0.630
2.5	0.583
3.3	0.530
5.0	0.4167

The amount of power delivered by the module is the voltage at the output terminals multiplied by the output current. When using the trim feature, the output voltage of the module can be increased, which at the same output current would increase the power output of the module. Care should be taken to ensure that the maximum output power of the module must not exceed the maximum rated power ( $V_{o.set} \times I_{o.max} \leq P_{max}$ ).

### Voltage Margining

Output voltage margining can be implemented in the DNL modules by connecting a resistor,  $R_{margin-up}$ , from the Trim pin to the ground pin for margining-up the output voltage and by connecting a resistor,  $R_{margin-down}$ , from the Trim pin to the output pin for margining-down. Figure 26 shows the circuit configuration for output voltage margining. If unused, leave the trim pin unconnected. A calculation tool is available from the evaluation procedure which computes the values of  $R_{margin-up}$  and  $R_{margin-down}$  for a specific output voltage and margin percentage.



**Figure 26:** Circuit configuration for output voltage margining

### Voltage Tracking

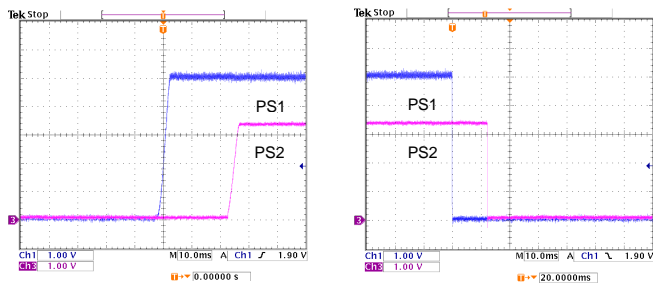
The DNL family was designed for applications that have output voltage tracking requirements during power-up and power-down. The devices have a TRACK pin to implement three types of tracking method: sequential start-up, simultaneous and ratio-metric. TRACK simplifies the task of supply voltage tracking in a power system by enabling modules to track each other, or any external voltage, during power-up and power-down.

By connecting multiple modules together, customers can get multiple modules to track their output voltages to the voltage applied on the TRACK pin.

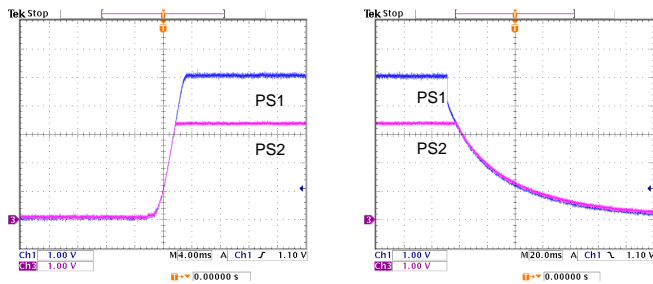
## FEATURE DESCRIPTIONS (CON.)

The output voltage tracking feature (Figure 27 to Figure 29) is achieved according to the different external connections. If the tracking feature is not used, the TRACK pin of the module can be left unconnected or tied to  $V_{in}$ .

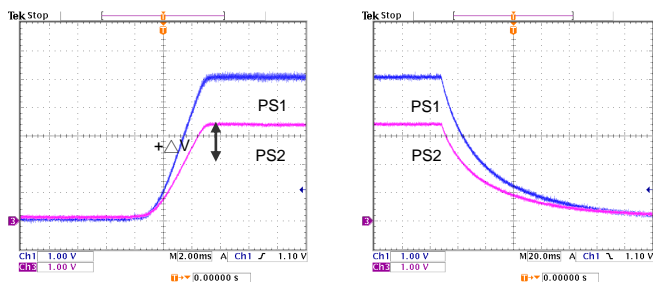
For proper voltage tracking, input voltage of the tracking power module must be applied in advance, and the remote on/off pin has to be in turn-on status. (Negative logic: Tied to GND or unconnected. Positive logic: Tied to  $V_{in}$  or unconnected)



**Figure 27: Sequential start-up**



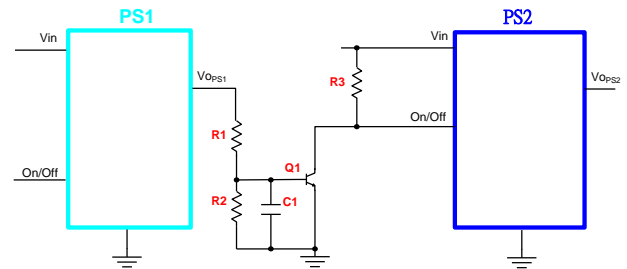
**Figure 28: Simultaneous**



**Figure 29: Ratio-metric**

### Sequential Start-up

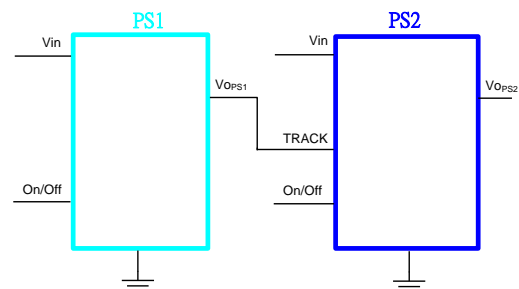
Sequential start-up (Figure 27) is implemented by placing an On/Off control circuit between  $V_{OP_{S1}}$  and the On/Off pin of PS2.



### Simultaneous

Simultaneous tracking (Figure 28) is implemented by using the TRACK pin. The objective is to minimize the voltage difference between the power supply outputs during power up and down.

The simultaneous tracking can be accomplished by connecting  $V_{OP_{S1}}$  to the TRACK pin of PS2. Please note the voltage apply to TRACK pin needs to always higher than the  $V_{OP_{S2}}$  set point voltage.



## FEATURE DESCRIPTIONS (CON.)

### Ratio-Metric

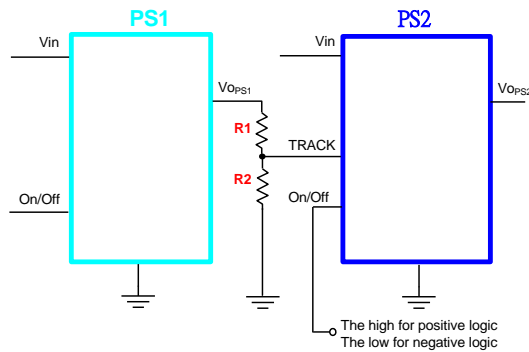
Ratio-metric (Figure 29) is implemented by placing the voltage divider on the TRACK pin that comprises R1 and R2, to create a proportional voltage with  $V_{O_{PS1}}$  to the Track pin of PS2.

For Ratio-Metric applications that need the outputs of PS1 and PS2 reach the regulation set point at the same time

The following equation can be used to calculate the value of R1 and R2.

The suggested value of R2 is 10kΩ.

$$\frac{V_{o,PS2}}{V_{o,PS1}} = \frac{R_2}{R_1 + R_2}$$



## THERMAL CONSIDERATIONS

Thermal management is an important part of the system design. To ensure proper, reliable operation, sufficient cooling of the power module is needed over the entire temperature range of the module. Convection cooling is usually the dominant mode of heat transfer.

Hence, the choice of equipment to characterize the thermal performance of the power module is a wind tunnel.

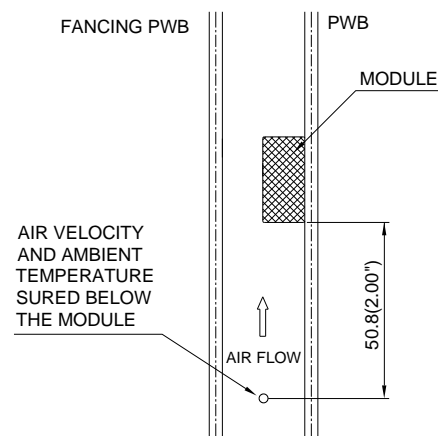
### Thermal Testing Setup

Delta's DC/DC power modules are characterized in heated vertical wind tunnels that simulate the thermal environments encountered in most electronics equipment. This type of equipment commonly uses vertically mounted circuit cards in cabinet racks in which the power modules are mounted.

The following figure shows the wind tunnel characterization setup. The power module is mounted on a test PWB and is vertically positioned within the wind tunnel. The height of this fan duct is constantly kept at 25.4mm (1").

### Thermal Derating

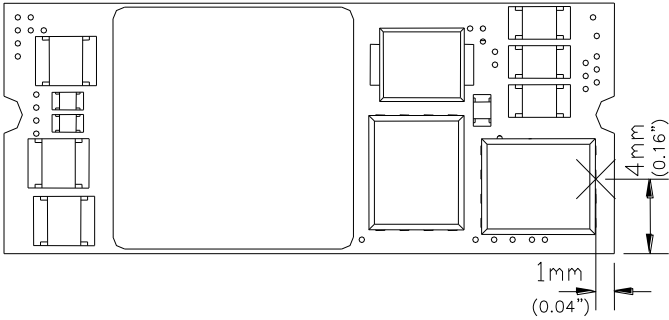
Heat can be removed by increasing airflow over the module. To enhance system reliability, the power module should always be operated below the maximum operating temperature. If the temperature exceeds the maximum module temperature, reliability of the unit may be affected.



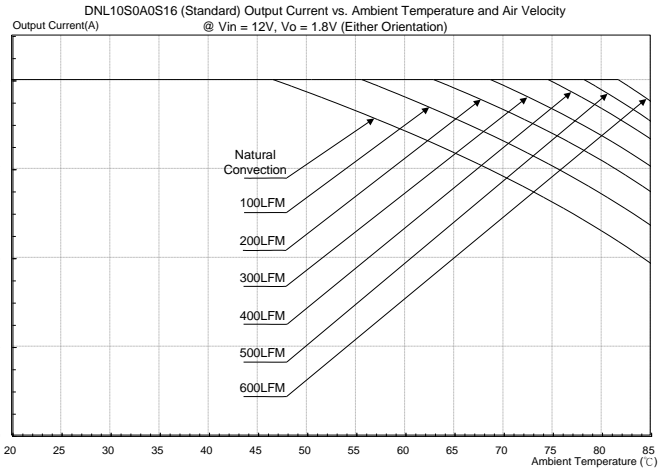
Note: Wind Tunnel Test Setup Figure Dimensions are in millimeters and (Inches)

Figure 30: Wind tunnel test setup

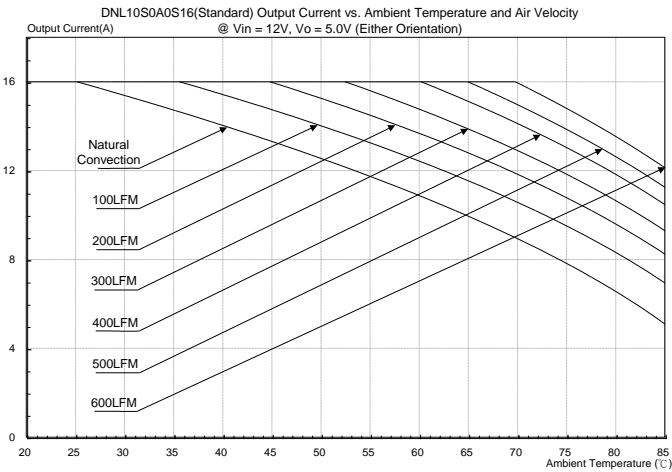
# THERMAL CURVES



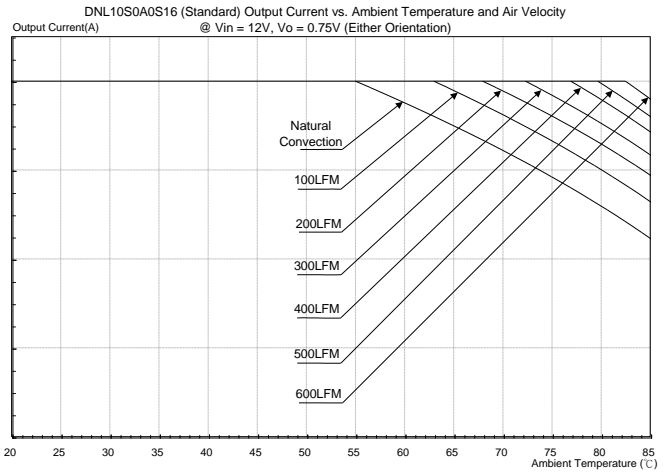
**Figure 31:** Temperature measurement location  
 \* The allowed maximum hot spot temperature is defined at 125°C.



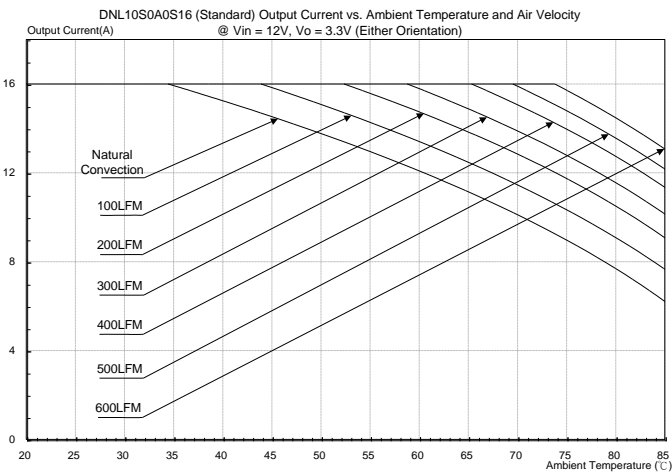
**Figure 34:** DNL10S0A0S16 (Standard) Output current vs. ambient temperature and air velocity @ Vin=12V, Vo=1.8V(Either Orientation)



**Figure 32:** DNL10S0A0S16 (Standard) Output current vs. ambient temperature and air velocity @ Vin=12V, Vo=5.0V(Either Orientation)



**Figure 35:** DNL10S0A0S16 (Standard) Output current vs. ambient temperature and air velocity @ Vin=12V, Vo=0.75V(Either Orientation)

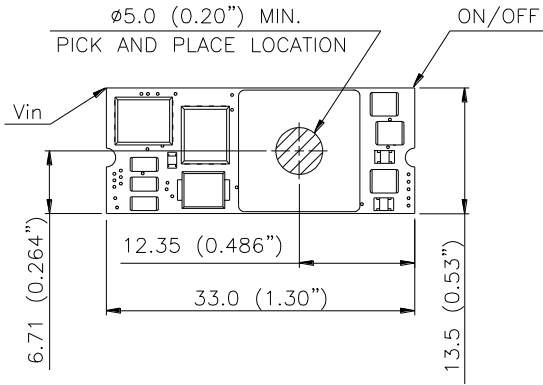


**Figure 33:** DNL10S0A0S16 (Standard) Output current vs. ambient temperature and air velocity @ Vin=12V, Vo=3.3V(Either Orientation)

DS\_DNL10SMD\_07182012

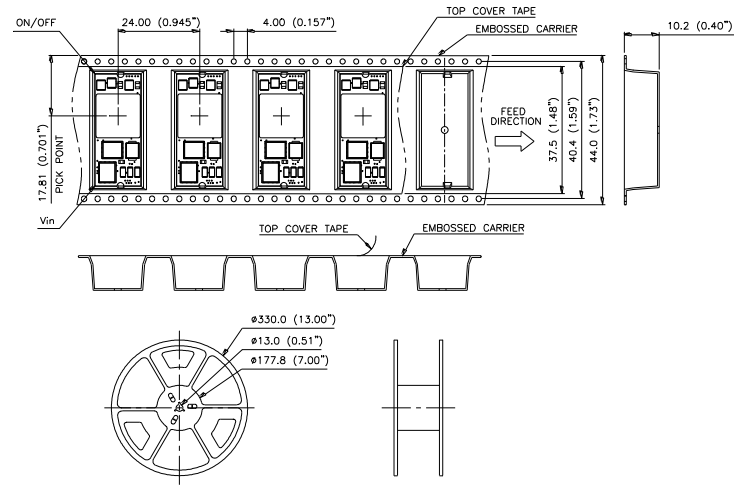


## PICK AND PLACE LOCATION

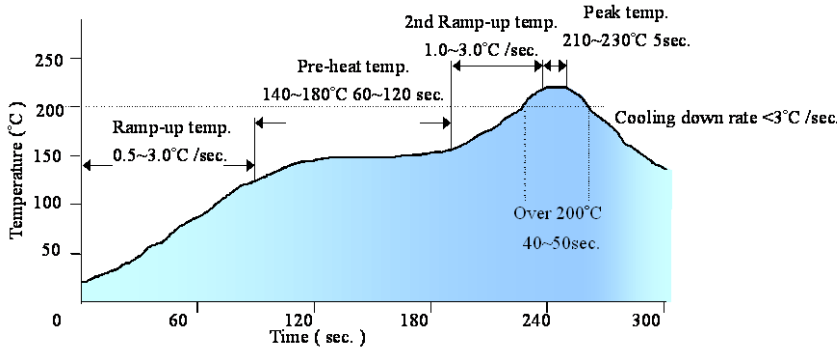


NOTES:  
 ALL DIMENSIONS ARE IN MILLIMETERS AND (INCHES)  
 TOLERANCES: X.Xmm±0.5mm(X.XX in.±0.02 in.)  
 X.XXmm±0.25mm(X.XXX in.±0.010 in.)

## SURFACE-MOUNT TAPE & REEL

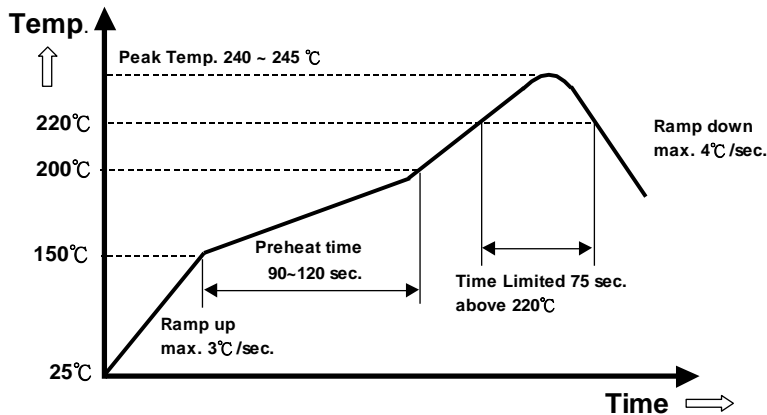


## LEADED (Sn/Pb) PROCESS RECOMMEND TEMP. PROFILE



*Note: All temperature refers to assembly application board, measured on the land of assembly application board.*

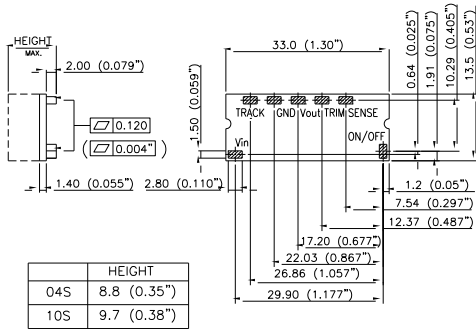
## LEAD FREE (SAC) PROCESS RECOMMEND TEMP. PROFILE



*Note: All temperature refers to assembly application board, measured on the land of assembly application board.*

# MECHANICAL DRAWING

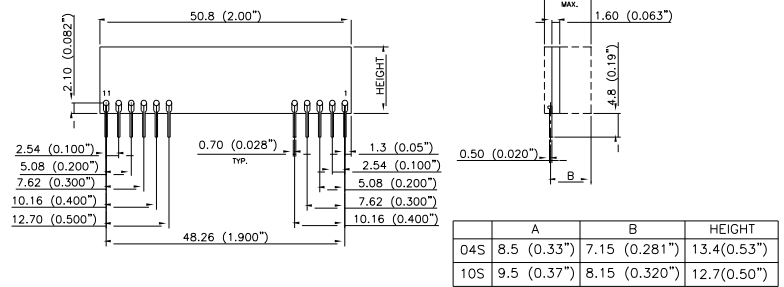
## SMD PACKAGE



SIDE VIEW

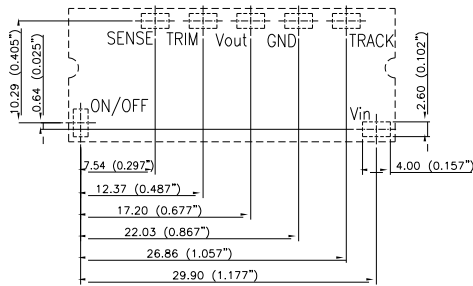
BOTTOM VIEW

## SIP PACKAGE (OPTIONAL)

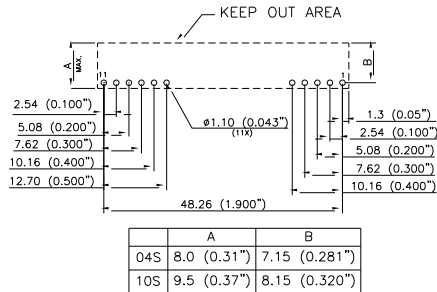


BACK VIEW

SIDE VIEW



RECOMMENDED P.W.B. PAD LAYOUT



RECOMMENDED P.W.B. PAD LAYOUT

NOTES:  
 DIMENSIONS ARE IN MILLIMETERS AND (INCHES)  
 TOLERANCES: X.Xmm±0.5mm(X.XX in.±0.02 in.)  
 X.XXmm±0.25mm(X.XXX in.±0.010 in.)

PIN#	Function
1	Vo
2	Vo
3	Vo SENSE
4	Vo
5	GND
6	GND
7	Vi
8	Vi
9	TRACK
10	TRIM
11	ON/OFF

## PART NUMBERING SYSTEM

DNL	10	S	0A0	S	16	N	F	D
Product Series	Input Voltage	Numbers of Outputs	Output Voltage	Package Type	Output Current	On/Off logic		Option Code
DNL - 16A DNM - 10A DNS - 6A	04 - 2.8~5.5V 10 - 8.3~14V	S - Single	0A0 - Programmable	R - SIP S - SMD	16 - 16A 10 - 10A 06 - 6A	N- Negative (Default) P- positive	F- RoHS 6/6 (Lead Free)	D - Standard Functions

## MODEL LIST

Model Name	Packaging	Input Voltage	Output Voltage	Output Current	On/Off logic	Efficiency 12Vin @ 100% load
DNL10S0A0S16PFD	SMD	8.3 ~ 14Vdc	0.75 V~ 5.0Vdc	16A	Positive	92.0%
DNL10S0A0S16NFD	SMD	8.3 ~ 14Vdc	0.75 V~ 5.0Vdc	16A	Negative	92.0%
DNL10S0A0R16PFD	SIP	8.3 ~ 14Vdc	0.75 V~ 5.0Vdc	16A	Positive	92.0%
DNL10S0A0R16NFD	SIP	8.3 ~ 14Vdc	0.75 V~ 5.0Vdc	16A	Negative	92.0%

### CONTACT: [www.deltaww.com/dc dc](http://www.deltaww.com/dc dc)

#### USA:

Telephone:  
East Coast: 978-656-3993  
West Coast: 510-668-5100  
Fax: (978) 656 3964  
Email: [DCDC@delta-corp.com](mailto:DCDC@delta-corp.com)

#### Europe:

Phone: +31-20-655-0967  
Fax: +31-20-655-0999  
Email: [DCDC@delta-es.com](mailto:DCDC@delta-es.com)

#### Asia & the rest of world:

Telephone: +886 3 4526107 ext 6220-6224  
Fax: +886 3 4513485  
Email: [DCDC@delta.com.tw](mailto:DCDC@delta.com.tw)

## WARRANTY

Delta offers a two (2) year limited warranty. Complete warranty information is listed on our web site or is available upon request from Delta.

Information furnished by Delta is believed to be accurate and reliable. However, no responsibility is assumed by Delta for its use, nor for any infringements of patents or other rights of third parties, which may result from its use. No license is granted by implication or otherwise under any patent or patent rights of Delta. Delta reserves the right to revise these specifications at any time, without notice.