



TDT & DRT SERIES

EMI FILTER FOR INVERTERS

COMPONENTS

PART NO.	Cx1(uF)	Cx2(uF)	Cy(nF)	L(mH)	Lg(uH)	R(KΩ)
16DRT1W3A	1.0	0.68	4.7	1.7	32	200
30DRT1W3	2.2	1.0	10	2.2	-	

*UL APPROVED

INTRODUCTIONS

1. Applications: Electric equipment, UPS, machine tool, copy machine, automation equipment, robot, AC motor drive
2. Voltage rating: 250VAC
3. Operating frequency: 50/60Hz

MINIMUM INSERTION LOSS IN dB

COMMON MODE (L-G) IN 50 OHM SYSTEM									
PART NO.	FREQUENCY-MHz								
	.01	.05	.10	.15	.50	1.0	5.0	10	30
16DRT1W3A	5	5	20	30	60	65	65	65	55
30DRT1W3	5	10	20	25	40	45	50	50	35

DIFFERENTIAL MODE (L-L) IN 50 OHM SYSTEM									
PART NO.	.01	.05	.10	.15	.50	1.0	5.0	10	30
16DRT1W3A	2	10	10	25	55	60	60	60	60
30DRT1W3	5	10	35	40	60	60	50	50	35

ELECTRICAL SCHEMATIC

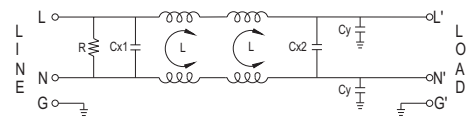
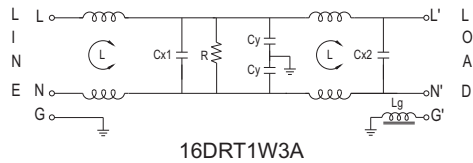

SERIES DIMENSIONS

PART NO.	DIMENSIONS IN INCHES/mm							
	A	B	C	D	E	F	G	H
16DRT1W3A	8.740	5.197	1.654	7.795	3.937	9.843	7.795	0.787
	222.0	132.0	42.0	198.0	100.0	250.0	198.0	20.0
30DRT1W3	10.906	7.956	2.047	9.961	6.693	7.874	9.961	0.984
	277.0	202.0	52.0	253.0	170.0	200.0	253.0	25.0

INSERTION LOSS (TYPICAL)

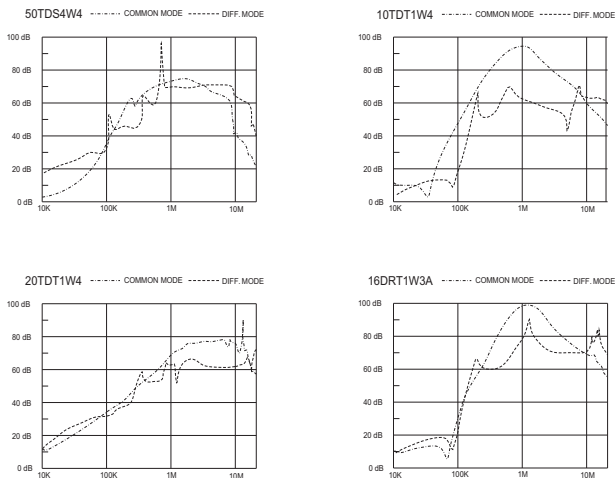

MECHANICAL CONSTRUCTION

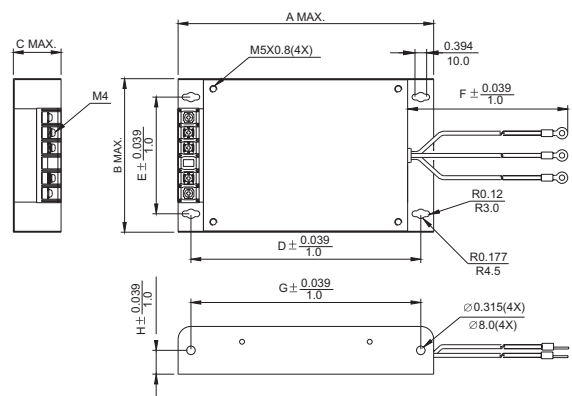
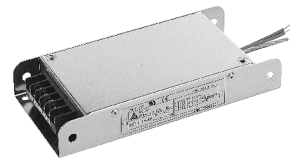

THREE-PHASE FILTERS



TDT & DRT SERIES

EMI FILTER FOR INVERTERS



COMPONENTS

PART NO.	Cx1(uF)	Cx2(uF)	Cy(nF)	L(mH)	Lg(uH)	R(KΩ)
10TDT1W4	0.68	-	10	23	5.2	560
10TDT1W4B	4.4	0.68	200	1.5	-	100
20TDT1W4		0.08	20		-	
21TDT1W4		1.0	47		800	
PART NO.	L (mH)	L1 (mH)	Cx (uF)	Cy (nF)	R (KΩ)	
50TDS4W4	0.5	0.2	6.6	100	100	

MINIMUM INSERTION LOSS IN dB

COMMON MODE (L-G) IN 50 OHM SYSTEM						
PART NO.	FREQUENCY-MHz					
	.15	.50	1.0	5.0	10	30
10TDT1W4	40	65	65	65	50	45
10TDT1W4B	60	60	60	60	40	35
20TDT1W4	25	35	40	50	40	25
21TDT1W4	45	65	65	60	30	15
50TDS4W4	40	65	65	45	35	5
DIFFERENTIAL MODE (L-L) IN 50 OHM SYSTEM						
10TDT1W4	10	40	50	45	45	50
10TDT1W4B	35	40	40	40	40	35
20TDT1W4	30	60	60	50	40	40
21TDT1W4	35	45	45	40	40	30
50TDS4W4	30	40	30	25	25	5

SERIES DIMENSIONS

PART NO.	DIMENSIONS IN INCHES/mm										
	A	B	C	D	E	F	G	H	I	J	K
10TDT1W4	8.740 222.0	5.197 132.0	1.654 42.0	7.795 198.0	3.397 100.0	9.843 250.0	7.795 198.0	0.787 20.0	-	-	-
10TDT1W4B	10.906 277.0	7.956 202.0	2.047 52.0	9.961 253.0	6.693 170.0	7.874 200.0	9.961 253.0	0.984 25.0	-	-	-
20TDT1W4											
21TDT1W4											
50TDS1W1	322 12.68	92 3.62	152 5.98	340 13.39	60 2.362	300 11.81	-	Ø7.0 Ø0.28	7.0x10.0 0.28x0.39	M6x1.0	363

MECHANICAL CONSTRUCTION

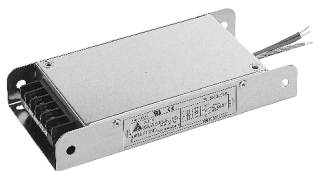

10TDT1W4/10TDT1W4S
20/21TDT1W4

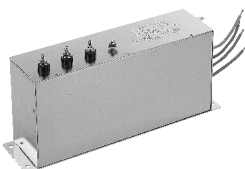

50TDS4W4

INTRODUCTIONS

1. Applications: Electric equipment, UPS, machine tool, copy machine, automation equipment, robot, AC motor drive
2. Voltage rating: 480VAC
3. Operating frequency: 50/60Hz

ELECTRICAL SCHEMATIC

