



Grid-tie Transformerless Hybrid Inverter

H8E / H10E

Operation and Installation Manual

Contents

- 1 General Information 05**
 - 1.1 Scope of delivery 05
 - 1.2 General Warnings / Notes on Safety 05
 - 1.3 Validity 06
 - 1.4 Product Description 06
- 2 Installation and Wiring 07**
 - 2.1 Instruction before Installation 07
 - 2.2 Unpacking 07
 - 2.3 Package Inspection 08
 - 2.4 Identification Label 09
- 3 Product Overview 10**
 - 3.1 Dimensions 10
 - 3.2 Function Introduction 10
 - 3.2.1 LED and Button 11
- 4 Installation 12**
 - 4.1 Installation Location 12
 - 4.2 Mounting 12
- 5 Wiring 15**
 - 5.1 Preparation before Wiring 15
 - 5.2 Opening the wiring box cover 16
 - 5.3 AC Grid Connection : L + N + PE 17
 - 5.4 DC Connection 18
 - 5.4.1 PV connector 18
 - 5.5 Battery connector 20
 - 5.6 Grounding 21
 - 5.7 Communication Module 22
 - 5.7.1 Communication connector 22
 - 5.8 Wi-Fi 23
- 6 Active/Reactive Power Control 24**
 - 6.1 Active Power Control 24
 - 6.1.1 Power vs. Voltage 24
 - 6.1.2 Power vs. Frequency 24
 - 6.2 Reactive Power Control 26
 - 6.2.1 Fixed Power Factor mode 26
 - 6.2.2 Fixed Reactive Power mode 26
 - 6.2.3 Voltage – var response mode 26
 - 6.3 Digital Input 26
 - 6.4 Power meter 28
 - 6.5 Operation Mode 29
 - 6.5.1 Self-consumption mode 29
 - 6.5.2 Peak cut mode 30
 - 6.5.3 Selling first mode 31
 - 6.5.4 Charge first mode 32
 - 6.5.5 Discharge first mode 33
 - 6.5.6 Standalone mode 34
 - 6.5.7 Forced charge mode 34
 - 6.5.8 Balance mode 35
 - 6.6 Battery Control Setting 35
- 7 System application 36**

8	Turning the PV inverter on/off	38
8.1	Start-up Procedures	38
8.1.1	DC Voltage Checking	38
8.1.2	AC Utility Voltage Checking	38
8.1.3	Starting up the Inverter	39
8.2	Shut down Procedures	39
9	Maintenance	40
10	Error Message and Trouble Shooting	41
11	De-Commissioning	44
12	Technical Data	45

Figure

Figure 1-1	: System diagram	06
Figure 2-1	: Unpacking process	07
Figure 2-2	: Components	08
Figure 2-3	: Components of power meter	08
Figure 2-4	: The identification label	09
Figure 3-1	: Dimensions	10
Figure 3-2	: Inverter exterior objects	10
Figure 3-3	: LED and Button	11
Figure 4-1	: Attaching the mounting bracket	13
Figure 4-2	: Correct and incorrect installation illustration	13
Figure 4-3	: Adequate installation gap	14
Figure 5-1	: Cable connections	15
Figure 5-2	: Remove the wiring box cover	16
Figure 5-3	: Locations of glands	16
Figure 5-4	: AC cable connection	17
Figure 5-5	: DC cable connection	19
Figure 5-6	: BAT cable connection	20
Figure 5-7	: Ground cable connection	21
Figure 5-8	: COMM. module location	22
Figure 5-9	: COMM. gland	22
Figure 5-10	: Installation of Wi-Fi antenna	23
Figure 6-1	: Digital input	27
Figure 6-2	: Digital input on COMM. module	27
Figure 6-3	: Power meter	28

Table

Table 2-1	: Packing list	08
Table 2-2	: Packing list of power meter	08
Table 3-1	: LED and Reset button function	11
Table 5-1	: Recommended upstream protection	17
Table 5-2	: H4 connectors	19
Table 5-3	: H4 connectors	20
Table 10-1	: Error Message	41
Table 10-2	: Fault Message	42
Table 12-1	: Specifications	45

1 General Information

1.1 Scope of delivery

This manual will assist you in becoming familiar with this product. Please observe all safety regulations and take into account the connection requirements by your local grid utility.

Only lithium batteries can be connected to the HxE inverters. Inverters have not been tested to AS/NZS 4777.2:2020 for multiple phase combinations.

1.2 General Warnings / Notes on Safety

Careful handling of the product will contribute to its service life durability and reliability. Both are essential to ensure maximum yield from your product.

CAUTION !



During operation of electrical devices, certain parts are under dangerous voltage. Inappropriate handling can lead to physical injury and material damage. Always adhere to the installation regulations. Installation may only be conducted by certified electricians.

WARNING !



Repair work on the device should ONLY be carried out by the manufacturer. The inverter contains no user serviceable parts inside. Please observe all points in the operation and installation manual. Isolate the device from the grid, the PV modules and the battery product before undertaking work on the device.

DANGER!



To avoid risk of electrical shock, do not open the solar inverter. The inverter contains no user-serviceable parts. Opening the inverter will void the warranty. Dangerous voltage is present for 60 seconds after disconnecting all sources of power, recommend 5 minutes for discharging. Remember that the unit has a high leakage current. The PE conductor MUST be connected prior to commencing operation.

WARNING !



The internal temperature may exceed over 70°C while operating. To avoid injury, do not touch the surface of the inverter whilst the unit is in operation.

ATTENTION



For operation and installation of inverter refer to the user manual. Failure to comply with the instructions in this manual may void the warranty.

1.3 Validity

This user manual describes the installation process, maintenance, technical data and safety instructions of H8E/H10E under the DELTA brand.

1.4 Product Description

This device is a single-phase grid-tie hybrid inverter. It converts DC electricity from the PV array with the stored energy into single phase AC to supply power to the load and feed the excess generated power back to the local grid.

This inverter allows for a wide voltage input range and has a high performance efficiency and user friendly operation. In addition, the special DSP (Digital Signal Processor) design reduces the complexity of the circuit and electronic components. The features of H8E/H10E and the extended hybrid system are shown below.

Features

- Max Output Power Rating: 8kVA (H8E), 10kVA (H10E)
- Single-phase (L + N + PE), Grid-tie, transformerless solar inverter
- Maximum efficiency : >98.0%
- Europe efficiency : 97.3%
- Reactive power capability (Cap 0.8 – Ind 0.8)
- Total harmonic distortion (THD < 3%) @ full load
- Battery-ready PV Inverter
- Built-in Consumption meter
- Synchronize standalone power function

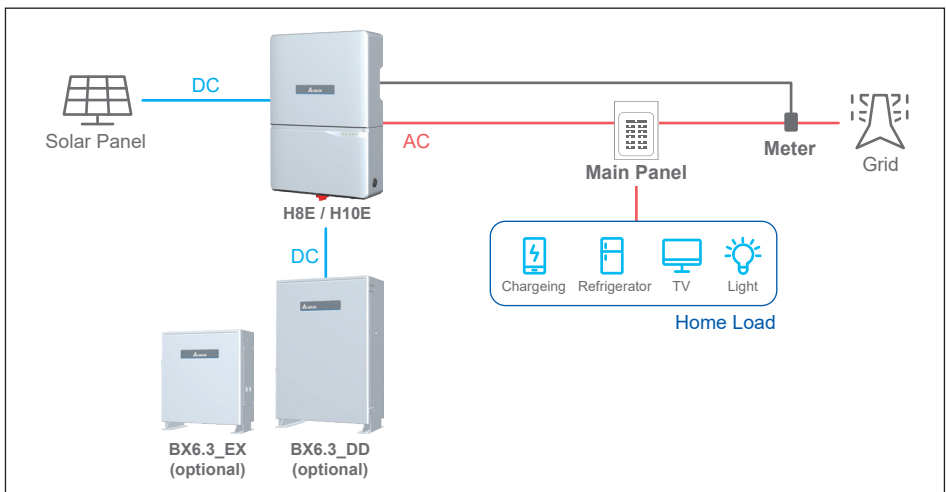

Figure 1-1 : System diagram

2 Package Inspection

2.1 Instruction before Installation

Due to the variety of users and installation environments, you must read this manual thoroughly before installation. Installation of the unit and start-up procedures must be carried out by an accredited technician.

2.2 Unpacking

Unpacking process is shown as **Figure 2-1**.

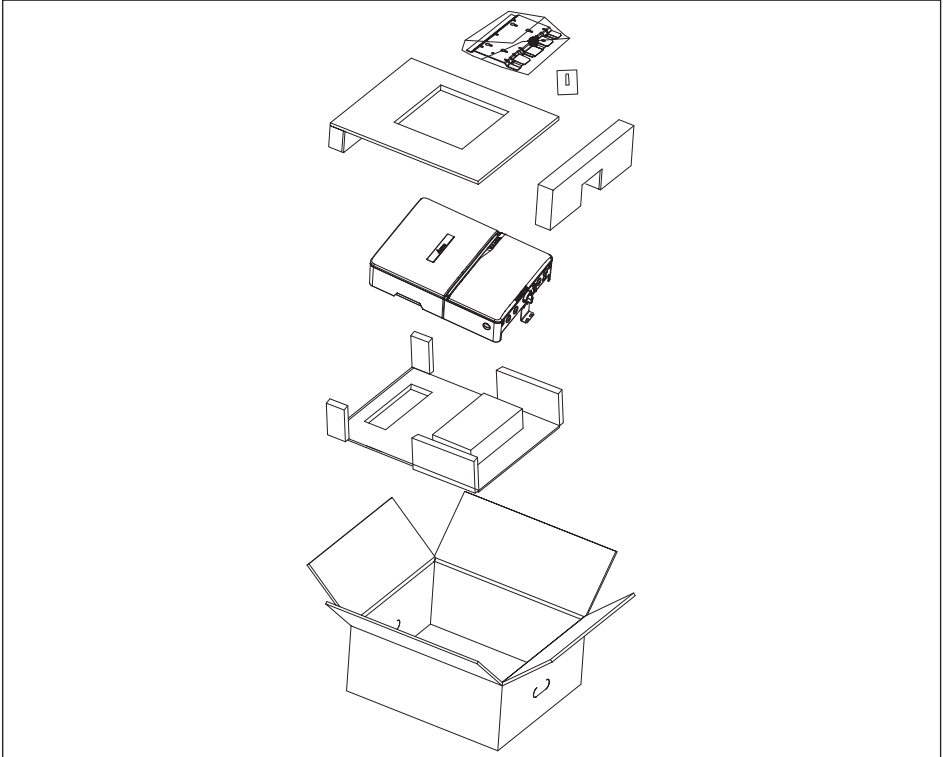

Figure 2-1 : Unpacking process

Upon receiving your brand new inverter, you will be required to remove its protective packaging. This packaging consists of various materials that will need to be disposed of according to the specific recycling marking printed on them.

CAUTION !



If there is any visible damage to the inverter/accesories or any damage to the packaging, please contact your inverter supplier before installation.

2.3 Package Inspection

Please check for damage on the packaging upon receiving your inverter. Please check the model number and the serial number on the packaging is identical with the model number and serial number on the unit itself. Check if all the accessories are in the package, the standard accessories are listed as **Table 2-1**.

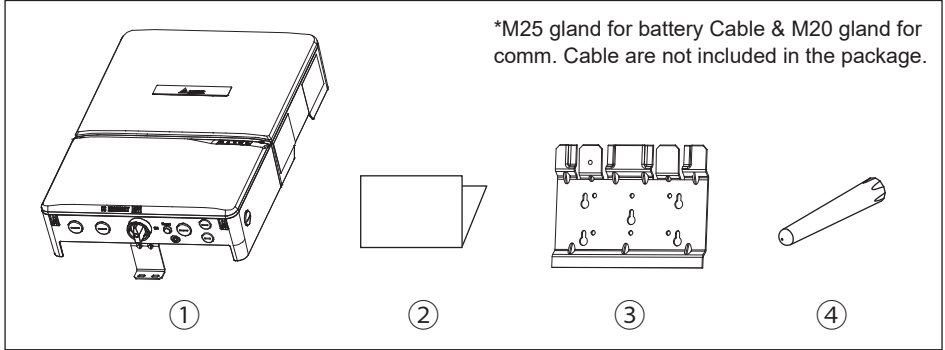

Figure 2-2 : Components

Table 2-1 : Packing list

H8E / H10E			
	Object	Qty	Description
①	PV Inverter	1	Solar inverter
②	Quick installation guide	1	Important safety instructions and technical specifications should be followed during installation.
③	Wall-Mount Bracket	1	To mount the solar inverter securely on the wall.
④	Antenna	1	For Wi-Fi communication

The CT is required to be installed at the service entrance or a proper control point for H8E/H10E for export limit function. The length of current sensor cable is available at 10m or 30m. The CT needs to be purchased separately.



Figure 2-3 : Components of power meter

Table 2-2 : Packing list of power meter

Power meter			
	Object	Qty	Description
①	Current sensor	1	Current sensor for power meter function.
②	Current sensor cable	1	Cable for current sensor, length of 10m or 30m.

2.4 Identification Label

Users can identify the model name by the information on the product label. The model name, serial number and other specifications can be located on the product label. For label location, please refer to **Figure 2-4**.

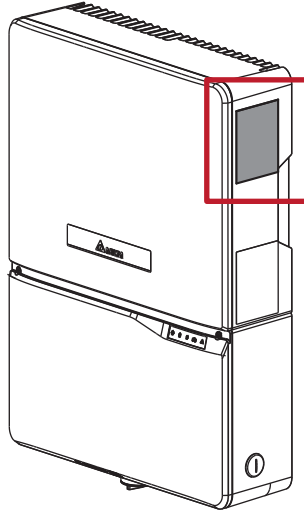

GRID-CONNECTED HYBRIDE INVERTER	
Model	H8E
PV DC Max. Input Voltage:	600 V
PV DC Operating Voltage Range:	50-540 V
PV DC Max. Input Current:	4x12 A
PV DC Max. Input Short Circuit Current:	4x20 A
Battery DC Max.Charge/Discharge Voltage:	540 V
Battery DC Operating Voltage Range:	350-540 V
Battery DC Max.Charge/Discharge Current:	20 A
AC Nominal Voltage:	Grid-tied 230 V Standalone 230 V
Max./Rated Continuous Current:	32 A 32 A
Rated Continuous Power:	7360 VA 7360 VA(Linear load)
Max. Continuous Power:	8000 VA 7360 VA(Linear load)
Nominal Frequency:	50 Hz 50 Hz
Output Power Factor:	0.8i-0.8c adj.
Ingress Protection:	IP65
Protective Class:	Class I
Over Voltage Category (AC Mains):	OVC III
Over Voltage Category (DC):	OVC II
Ambient Temperature:	-25 - +65°C
Topology of Inverter:	Non-isolated
IEC 62109-1,-2 AS/NZS 4777.2:2020	
RP1802H240000 Rev.:XX Date Code:YYWW PIN: PPPP S/N:MMMYWWRRZZZ	
	Made in China
<small>Delta Electronics (Netherlands) B.V. Zandsteen 15, 2132 MZ Hoofddorp, The Netherlands.</small>	

GRID-CONNECTED HYBRIDE INVERTER	
Model	H10E
PV DC Max. Input Voltage:	600 V
PV DC Operating Voltage Range:	50-540 V
PV DC Max. Input Current:	4x12 A
PV DC Max. Input Short Circuit Current:	4x20 A
Battery DC Max.Charge/Discharge Voltage:	540 V
Battery DC Operating Voltage Range:	350-540 V
Battery DC Max.Charge/Discharge Current:	20 A
AC Nominal Voltage:	Grid-tied 230 V Standalone 230 V
Max./Rated Continuous Current:	40 A 40 A
Rated Continuous Power:	9200 VA 9200 VA(Linear load)
Max. Continuous Power:	10000 VA 9200 VA(Linear load)
Nominal Frequency:	50 Hz 50 Hz
Output Power Factor:	0.8i-0.8c adj.
Ingress Protection:	IP65
Protective Class:	Class I
Over Voltage Category (AC Mains):	OVC III
Over Voltage Category (DC):	OVC II
Ambient Temperature:	-25 - +65°C
Topology of Inverter:	Non-isolated
IEC 62109-1,-2 AS/NZS 4777.2:2020	
RP1103H240000 Rev.:XX Date Code:YYWW PIN: PPPP S/N:MMMYWWRRZZZ	
	Made in China
<small>Delta Electronics (Netherlands) B.V. Zandsteen 15, 2132 MZ Hoofddorp, The Netherlands.</small>	

Figure 2-4 : The identification label

3 Product Overview

3.1 Dimensions

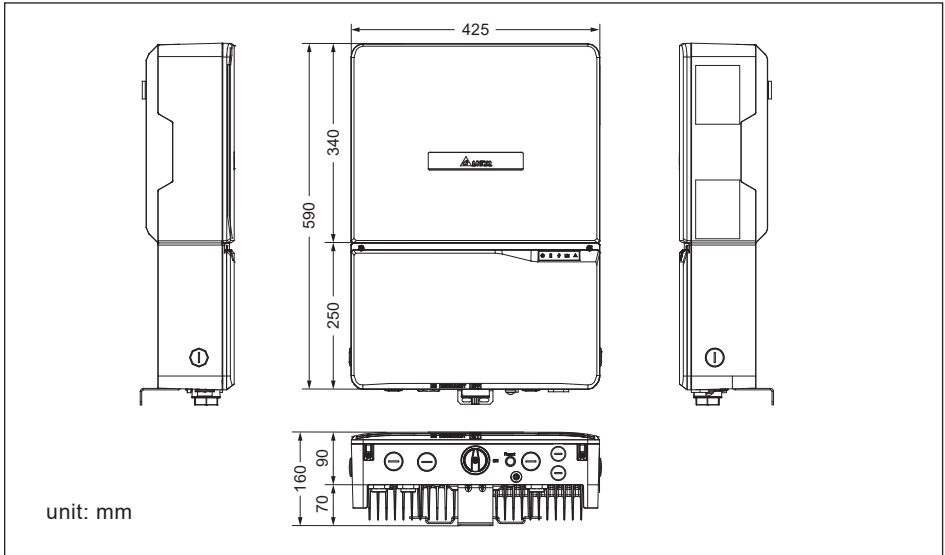

Figure 3-1 : Dimensions

3.2 Function Introduction

The Inverter's exterior is shown in **Figure 3-2**.

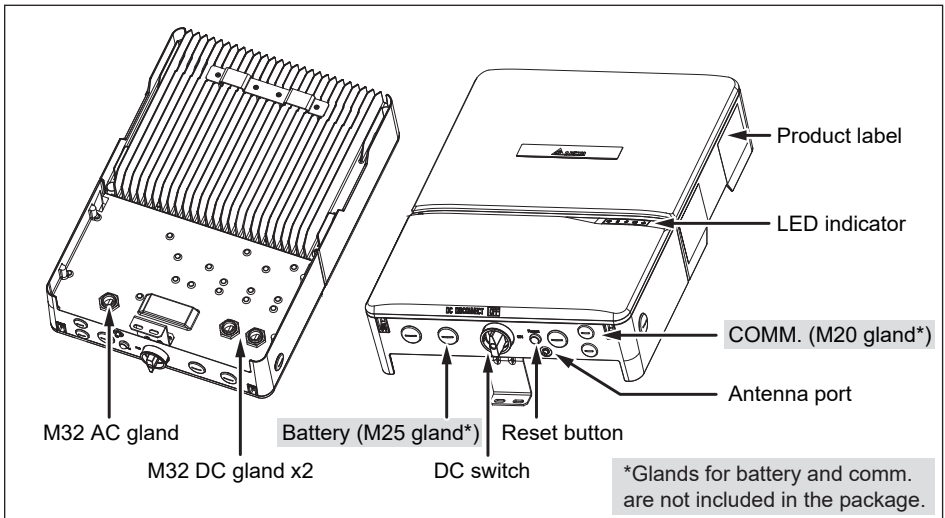













Figure 3-2 : Inverter exterior objects

3.2.1 LED and Button

There are 5 LEDs in the front side of the inverter, from left to right, it is used for indicating status of operation, battery, communication, information and fault.

Table 3-1 : LED and Reset button function

LED	Color	Action	Status
	Green	Steady on	The inverter feeds in grid.
	Green	Bar*	The inverter is synchronizing with grid. *4 LEDs form a progress bar, for example:  ON -  ON -  blink -  off, means synchronization progress is 50-75%.
	Green	1s on, 4s off	Grid is connected, but the inverter is unable to feed in grid because PV voltage is too low.
	Green	Steady on	Battery is in normal operation.
	Red	Steady on	Battery is in fault mode.
	Yellow	Steady on	Battery communication timeout.
	Yellow	1s on, 2s off	Battery is in standby mode.
	Green	500ms on, 500ms off	Reboot Wi-Fi (Press Button 3~10s)
	Green	1s on, 1s off	Reset password & Wi-Fi settings (Press Button 20~30s)
	Yellow	1s on, 1s off	Firmware upgrading is ongoing.
	Green	1s on, 1s off	Inverter is receiving image file.
	Yellow	Steady on	External event occurs, inverter is unable to run.
	Red	1s on, 1s off	Earth fault occurs*
	Green	On until done	Inverter initialization when grid is changing from disconnected into connected.

*In the event of an Earth Fault, the inverter will shut down immediately and the red LED will be flashing. Also the earth fault will be indicated from APP if the APP is connected.

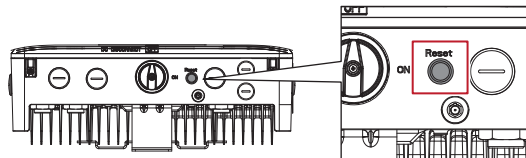

Reset button	 LED Action	Description
Push 3s~10s	500ms on, 500ms off	Reset Wi-Fi module
Push 20s~30s	1s on, 1s off	Reset Wi-Fi module, and Wi-Fi password returns to the default: DELTASOL

4 Installation

4.1 Installation Location

The inverter can be installed in indoors / outdoors.

WARNING !



Do not install the unit near or on flammable surfaces.
Mount the unit tightly on a solid/smooth surface.

CAUTION !



The unit should not be installed in direct sunlight.

4.2 Mounting

This unit is designed to be wall-mounted. Please ensure the installation is perpendicular to the floor and the AC plug located at the base of the unit. Do not install the device on a slanting wall. The dimensions of the mounting bracket are shown in the figure below.

To mount the inverter on the wall, please follow the procedure below:

- 1.Screw the mounting bracket on the wall with 4 * $\Phi 6$ mm Phillips head screws.
- 2.Attach the inverter to the mounting bracket.
- 3.Secure the reinforced bracket with 2 M6 screws as **Figure 4-1**.

The inverter must be installed vertically with a maximum incline of $\pm 5^\circ$ on a flat surface as **Figure 4-2**.

CAUTION !



- The bracket supplied with the unit is specially designed and should be the only mounting device used for the unit.
- It is recommended to install the inverter in a suitable location which offers easy and safe access for service and maintenance.
- Please leave an appropriate gap in between units when installing multiple solar inverter systems (refer to **Figure 4-3**).
- Please install solar inverter at eye level to allow easy observation for operation and parameter setting.
- Ambient temperature for operation: $-25^\circ\text{C}\sim+65^\circ\text{C}$ (power derating above 40°C).

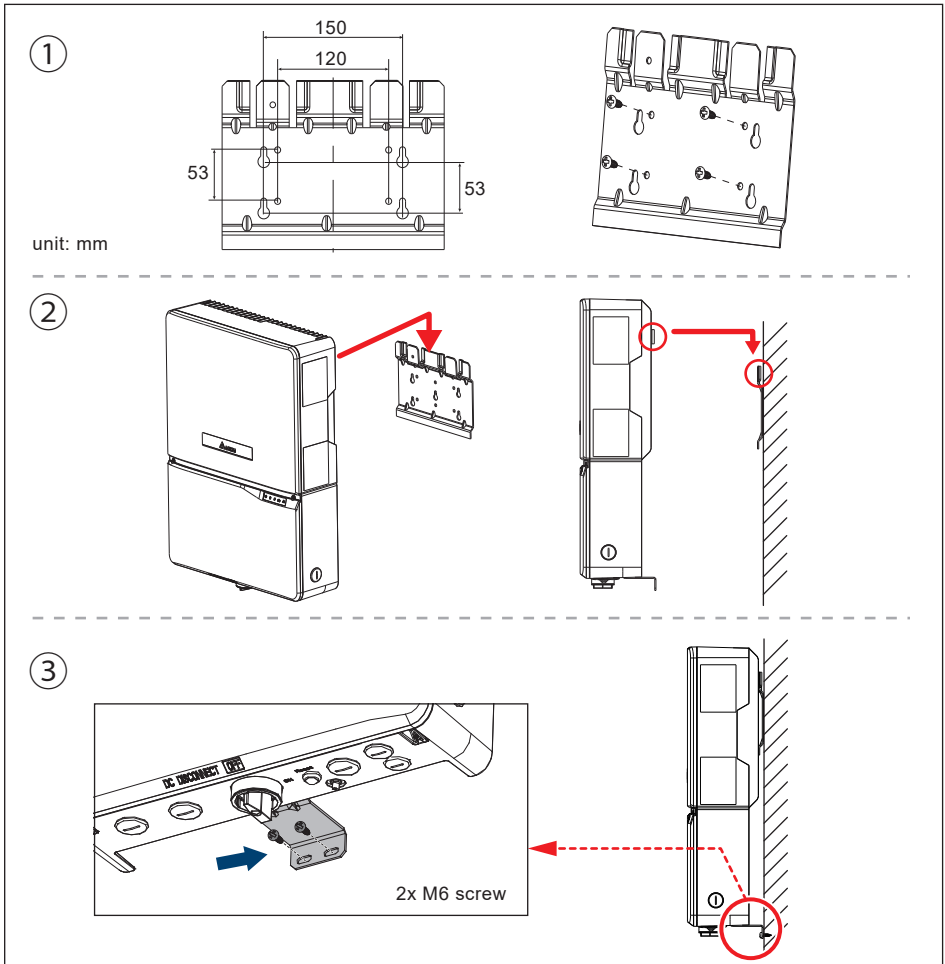

Figure 4-1 : Attaching the mounting bracket

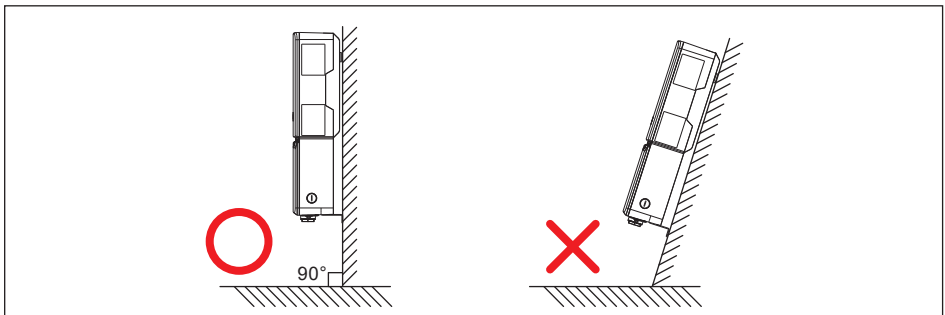

Figure 4-2 : Correct and incorrect installation illustration

Please ensure the spacing requirement to allow for sufficient convective cooling. It is essential to ensure sufficient space for product operation as shown in **Figure 4-3**.

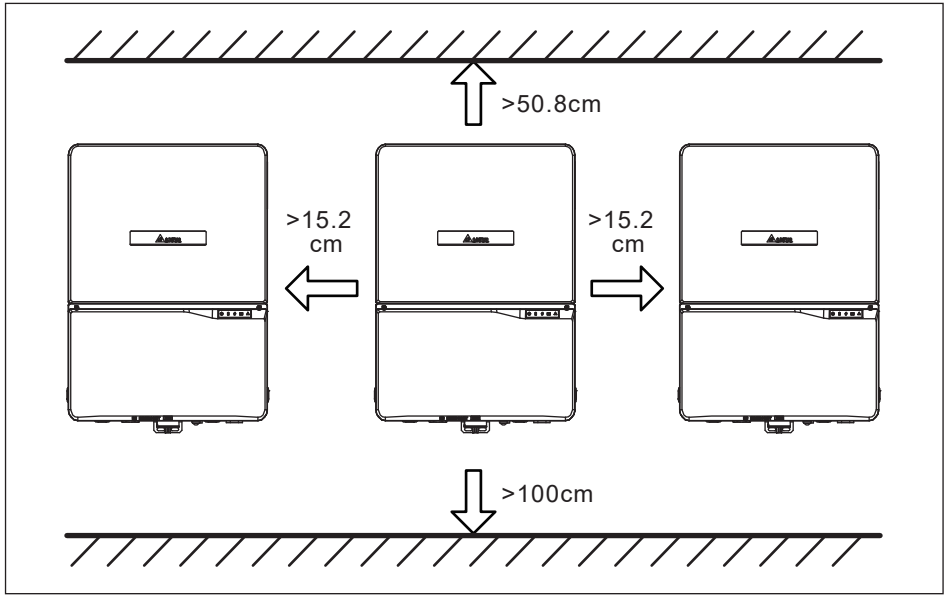

Figure 4-3 : Adequate installation gap

5 Wiring

5.1 Preparation before Wiring

1. Ensure voltage values and polarities are correct.
2. Ensure PV Switch is set to OFF, and BX6.3_DD system is shutdown.
3. When grounding the solar array positive or negative terminal, an isolation transformer is required due to the inverter has no galvanic isolation between the DC-input and AC-output.
4. The ground fault detection is a fixed internal setting. It cannot be modified.
5. Please refer to **Figure 5-1** for connections. Inverter can accept DC inputs in parallel.
6. According to IEC 62109-2, the PV modules need to have an IEC 61730 Class A rating.

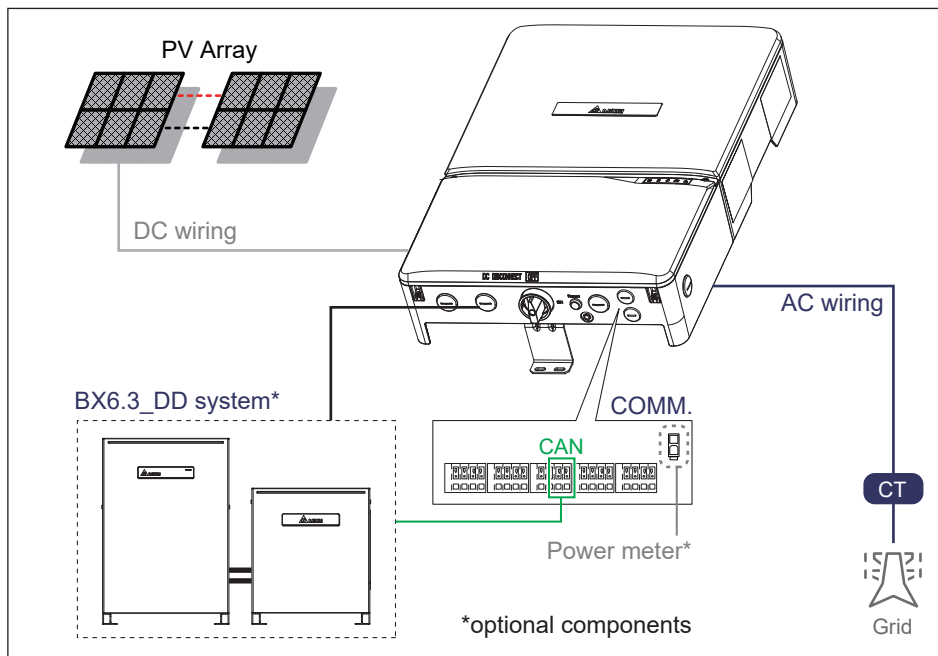

Figure 5-1 : Cable connections

WARNING! SHOCK HAZARD



When the photovoltaic array is exposed to light, it supplies a DC voltage to the Inverter, a shock hazard may exist due to output wires or exposed terminals. To reduce the risk of shock during installation, cover the array with an opaque (dark) material and ensure that the Disconnect Device in the inverter is set to OFF before commencing any wiring.

5.2 Opening the wiring box cover

1. Place DC Disconnect switch in “OFF” position. Please note the cover cannot be removed when the DC Disconnect switch is in the “ON” position.
2. Remove the 4 cover screws indicated above with a T20 Torx screw driver.
3. Lift the cover upward and place off to the side.

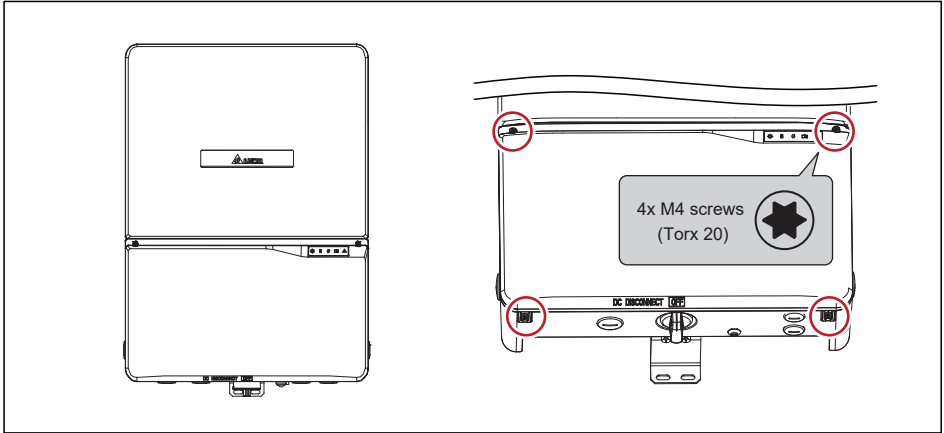
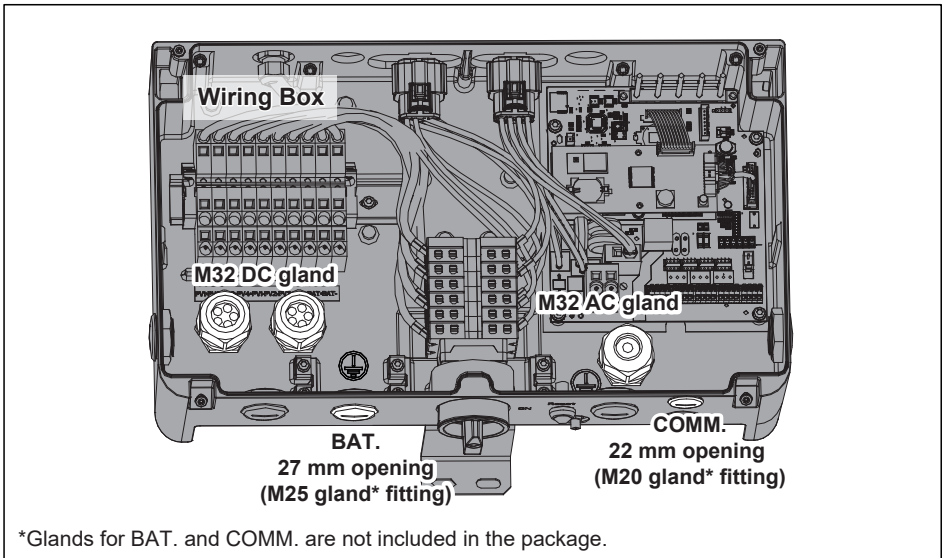

Figure 5-2 : Remove the wiring box cover



*Glands for BAT. and COMM. are not included in the package.

Figure 5-3 : Locations of glands

5.3 AC Grid Connection : L + N + PE

WARNING !



Before commencing AC wiring, please ensure all AC circuit breakers are switched off.

	Power rating	Upstream AC circuit breaker
H8E	8 kVA	40A
H10E	10 kVA	50A

Table 5-1: Recommended upstream protection

The AC wire connection with the inverter can be used with flexible or rigid copper cable. When calculating the cross section of the cable, consider:

- material used
- thermal conditions
- cable length
- type of installation
- AC voltage drop
- power losses in cable

Always follow the system installation requirements defined for your country!

AC cables connection

The AC compatible wiring gauge is 6mm^2 - 16mm^2 , should have an ampacity based on AS/NZS 4777.1, it is recommended to use 90°C (194°F)

1. The AC compatible wiring gauge is 6mm^2 - 16mm^2 . Route AC wire through the conduit and strip the wire end to 18mm.
2. Use 5mm(3/16inch) flat blade screw driver to push the spring of each terminal.
3. Connect the wires (L, N) to the connectors according to the marks. Connect the wire (GND) to the grounding terminal.

- Note: Verify the connection is correct.

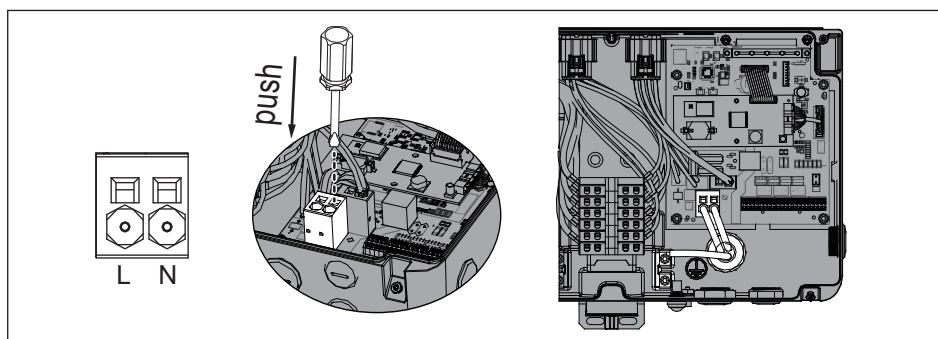
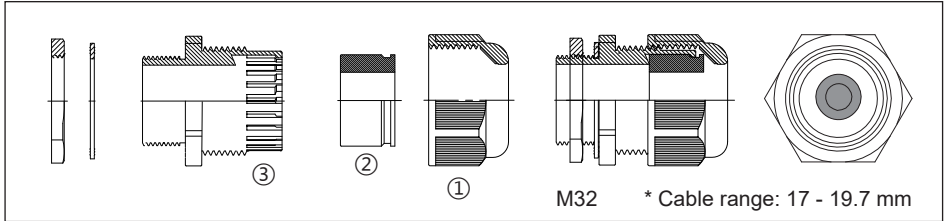

Figure 5-4 : AC cable connection

Installation of the AC Cable Gland



1. Loosen the front cover ① counterclockwise.
2. Remove the rubber washer ② from the fastening ring ③.
3. Connect the cable with the terminal.
4. Install the rubber washer ② to the fastening ring ③.
5. Surely tighten the front cover ①.

5.4 DC Connection

WARNING !



- When undertaking DC wiring, please ensure the correct polarities are connected.
- When undertaking DC wiring, please ensure that the DC isolator switch on the PV array is OFF.
- When undertaking BAT wiring, please ensure that the BX6.3_DD system is shutdown.

CAUTION !



The maximum open circuit voltage of the PV Array must not exceed 600Vdc.

NOTE



The DC isolator integrated in the inverter is DC PV2 isolation device which can meet the requirement of AS 4777.1. And it was evaluated the compatible test with inverter.

5.4.1 PV connector

The inverter operate using two separate MPP trackers that can handle both symmetrical and asymmetrical loads to allow for optimum adjustment.

This allows for the requirements of complex PV system designs to be fulfilled.

MPP range with Max. power	H8E/H10E
Symmetrical load	280~480V
Asymmetrical load	280~480V
Max. ratio for asymmetrical load	81/19%;19/81%

DC cables connection

The PV compatible wiring gauge is $4\text{mm}^2 - 6\text{mm}^2$, should have an ampacity based on AS/NZS 4777.1, it is recommended to use $90^\circ\text{C}(194^\circ\text{F})$

Connection PV cables according to following:

1. Route the PV wires through the conduit, and strip the wire end to 12mm.
2. Use 5mm (3/16 inch) flat blade screw driver to push the spring of each terminal.
3. Connect the positive wires to PV+ terminals and connect the negative wires to PV- terminals.

- Note: Verify the connection before power up the inverter.

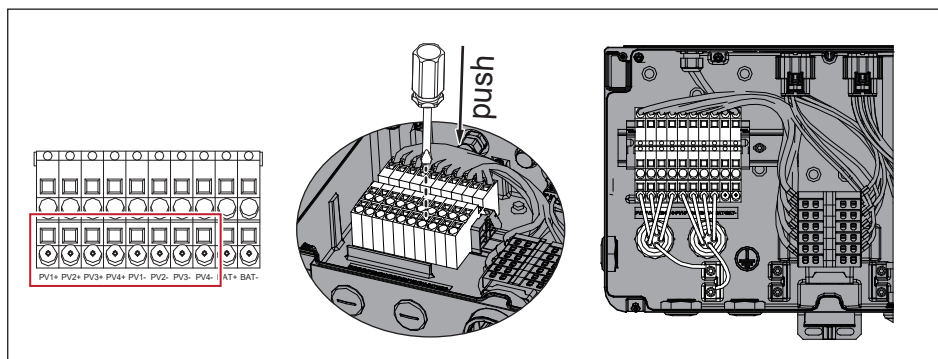
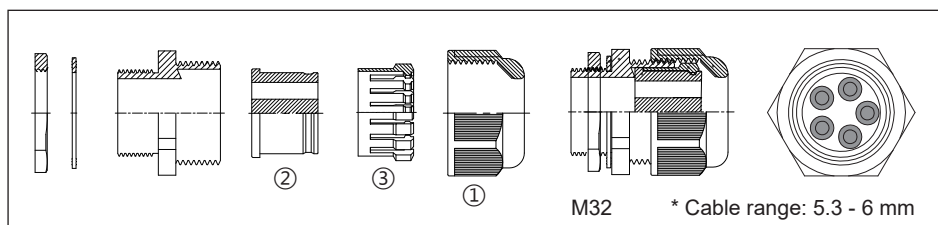

Figure 5-5 : AC cable connection

Installation of the DC Cable Gland



1. Loosen the front cover ① counterclockwise.
2. Remove the rubber washer ② from the fastening ring ③.
3. Connect the cable with the terminal.
4. Install the rubber washer ② to the fastening ring ③.
5. Surely tighten the front cover ①.

5.5 Battery connector

The BAT compatible wiring gauge is $4\text{mm}^2 - 6\text{mm}^2$, should have an ampacity based on AS/NZS 4777.1, it is recommended to use $90^\circ\text{C}(194^\circ\text{F})$

Connection PV cables according to following:

1. Route the BAT wires through the conduit, and strip the wire end to 12mm.
2. Use 5mm (3/16 inch) flat blade screw driver to push the spring of each terminal.
3. Connect the positive wires to BAT+ terminals and connect the negative wires to BAT- terminals.

- Note: Verify the connection before power up the inverter.

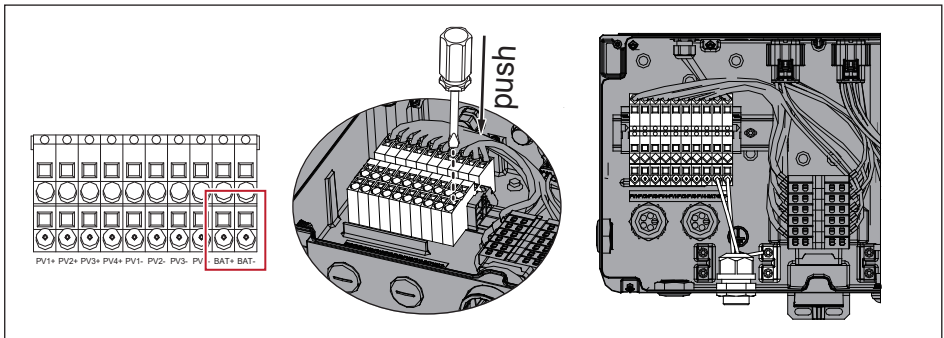

Figure 5-6 : BAT cable connection

NOTE



M25 gland for battery cable is not included in the package.

Recommended BAT Cable Gland

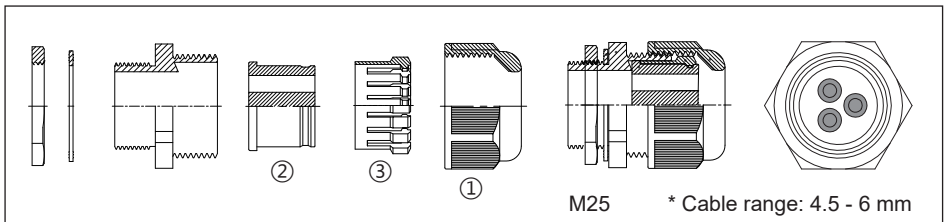

1. Loosen the front cover ① counterclockwise.
2. Remove the rubber washer ② from the fastening ring ③.
3. Connect the cable with the terminal.
4. Install the rubber washer ② to the fastening ring ③.
5. Surely tighten the front cover ①.

5.6 Grounding

Six Grounding Electrode Conductors are installed inside the wiring box, they are torx head screw type connectors. The terminals accept solid or stranded copper 6mm^2 - 22mm^2 wire, recommend screw torque is 18 in-lbs (2N-m).

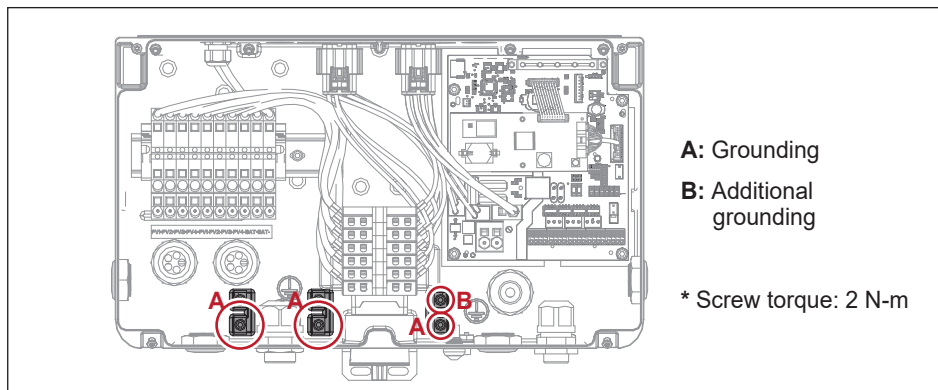

Figure 5-7 : Ground cable connection

WARNING !



- As the leakage current is too large, an additional grounding point is provided in the wiring box as below.
 The additional grounding point must be reliable grounding.
 The minimum size of the additional grounding wire is 6mm^2 .

5.7 Communication Module

The communication module of H8E/H10E is shown below. It provides VCC(12V), RS-485, CAN and digital input terminals for various applications.

Connect battery BMS communication cable to inverter communication terminal of CAN-L-DD, CAN-H-DD.

Please refer to **Chapter 6.3** for the information of digital input.

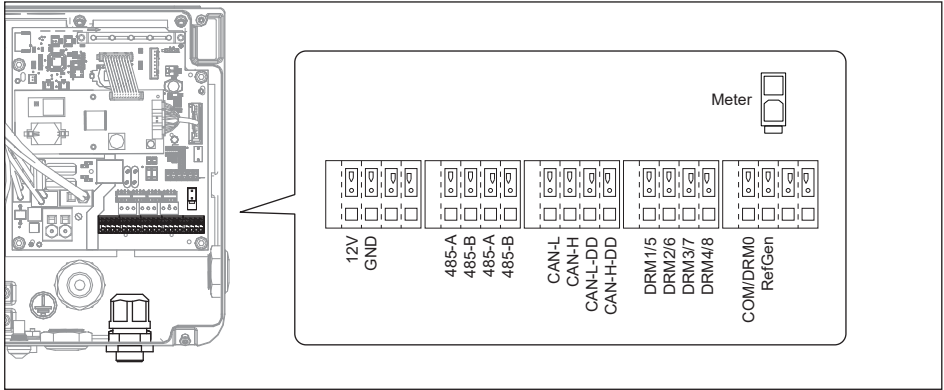

Figure 5-8 : COMM. module location

5.7.1 Communication connector

NOTE



M20 gland for communication cable is not included in the package.

Recommended Communication Cable Gland

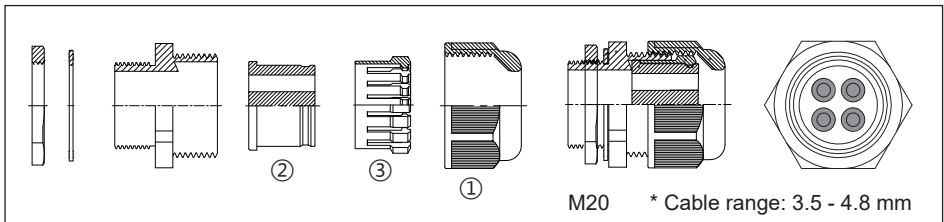

Figure 5-9 : COMM. gland

5.8 Wi-Fi

The communication module supports the inverter to communicate with devices (such as smartphones, tablets, etc.) via Wi-Fi (base WPA2-PSK).

There is an antenna for Wi-Fi in the package (item 4, **Table 2-1**), which must be mounted on the plastic carrier as shown below.

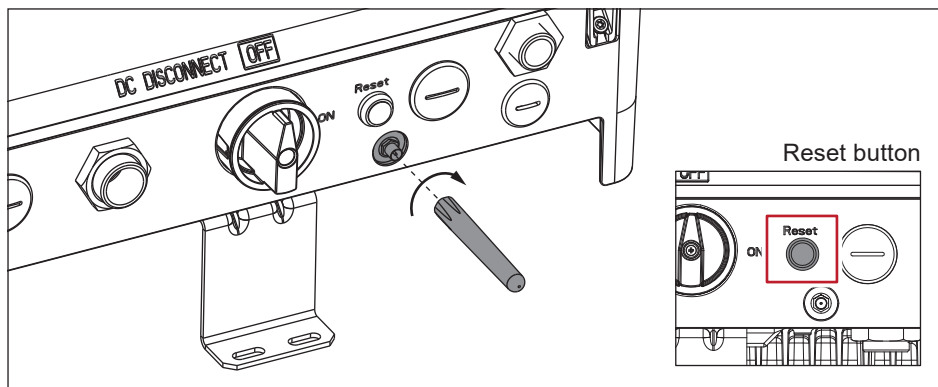
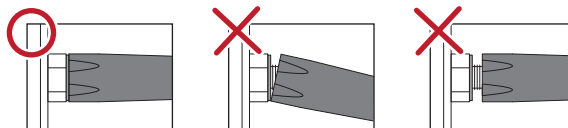

Figure 5-10 : Installation of Wi-Fi antenna

Reset button	LED Action	Description
Push 3s~10s	500ms on, 500ms off	Reset Wi-Fi module
Push 20s~30s	1s on, 1s off	Reset Wi-Fi module, and Wi-Fi password returns to the default: DELTASOL

ATTENTION

- Please properly install the antenna as shown below to keep communication quality and avoid equipment damage.



- More detail for Wi-Fi connection and APP : <https://mydeltasolar.deltaww.com/index.php?p=manual>



- To establish a successful communication between Inverter Wi-Fi to MyDeltaSolar Cloud, in the Wi-Fi connection setup page, the signal strength must be above -70dBm between each Wi-Fi device (Wi-Fi router, inverter, DC1...etc.). In case the signal strength is below -70dbm, it may cause certain communication errors which may prevent a successful Wi-Fi communication. To avoid such issues, please adjust the Wi-Fi device position to improve the signal strength/quality.

6 Active/Reactive Power Control

There are 2 settings for active power and 4 settings for reactive power control that can be configured based on the requirement of the local network operator.

ATTENTION



The parameters are set according to the requirements of the selected country. A change to the parameter settings may result in the approval being lost.

6.1 Active Power Control

6.1.1 Power vs. Voltage

According to AS/NZS 4777.2:2020:

The volt-watt response mode varies the output power of the inverter in response to the voltage at its terminal. The inverter should have the volt-watt response mode. This mode is enabled by default.

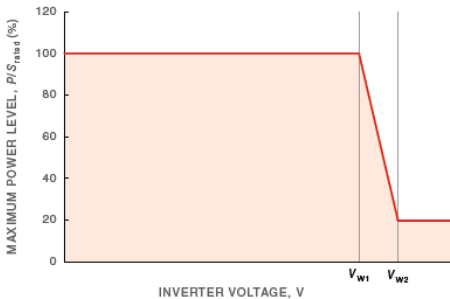

curve for the volt-watt response mode

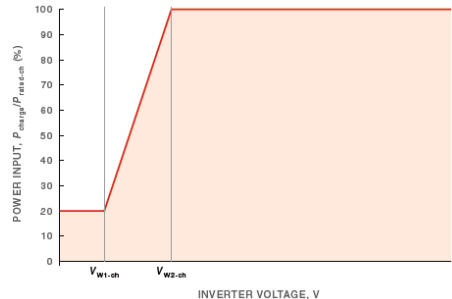

curve for the volt-watt response mode for multiple mode inverters with energy storage when charging

6.1.2 Power vs. Frequency

According to AS/NZS 4777.2:2020:

For response to an increase in frequency, when a disturbance results in an increase in frequency that exceeds the continuous operation range (f_{ULCO}), Delta H8E/H10E inverter will reduce the power output linearly with the increase in frequency until f_{Pmin} is reached. When a disturbance results in an increase in frequency that exceeds $f_{transition}$, Delta H8E/H10E inverter will increase the power input level through the grid-interactive port, linearly with the increase in frequency until f_{Pmin} is reached, the maximum charge rate of the energy storage is reached, or the state of charge of the energy storage is full.

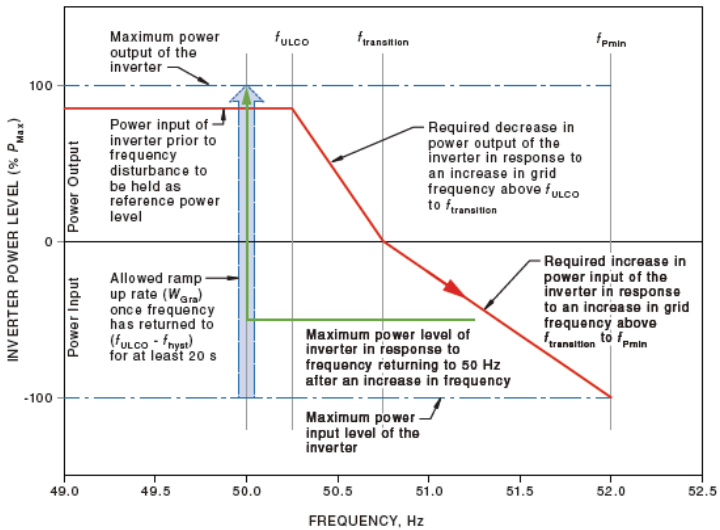

For response to a decrease in frequency, when a disturbance results in a decrease in frequency below the continuous operation range (f_{LLCO}), Delta H8E/H10E inverter will increase the power output linearly with the decrease in frequency until the lower limit frequency range (f_{Pmax}) is reached. When a disturbance results in a decrease in frequency that falls below $f_{stop-ch}$, Delta H8E/H10E inverter with energy storage will increase the power output level through the grid-interactive port linearly with the decrease in frequency until f_{Pmax} is reached, the maximum discharge rate of the energy storage is reached, or the state of charge of the energy storage is exhausted.

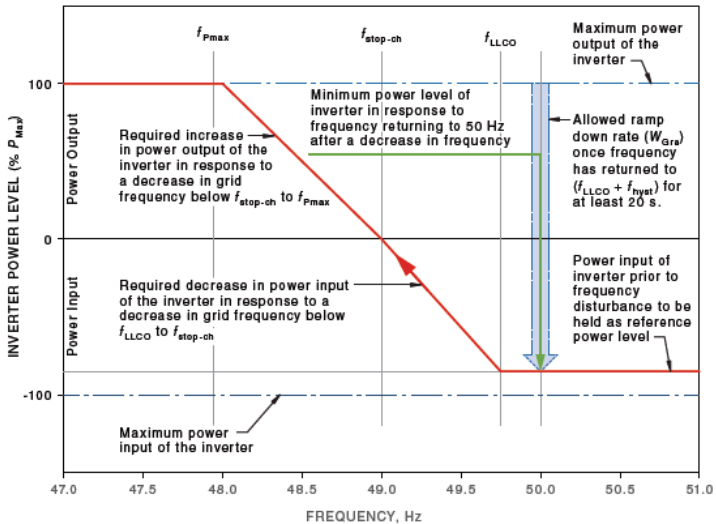

6.2 Reactive Power Control

6.2.1 Fixed Power Factor mode

Users can set the power factor from Cap 0.80 to Ind 0.80 (inverter would stop reactive power control if output power is below 25% rated power).

This mode is disabled by default.

6.2.2 Fixed Reactive Power mode

Once user enables this method, the inverter will deliver reactive power (i.e. Q) consistent with that of the fixed reactive power setting. The setting range is from Cap 60% to Ind 60%. This mode is disabled by default.

6.2.3 Voltage – var response mode

Once the user enables this method, the user can set Q vs. Grid voltage operation curve as in figure below. This mode is disabled by default.

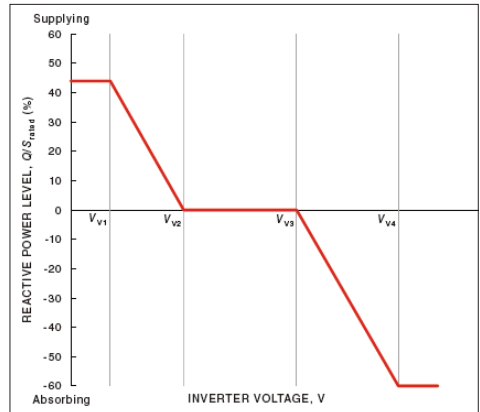

6.3 Digital Input

To implementation of power management, the digital input interface receives the specifications of the network operator via a ripple control receiver or a DRED.

- **Australia and New Zealand:**

The inverter support the demand response mode (DRMs).

DRM 0 - Operate the disconnection device.

DRM 1 - Do not consume power

DRM 2 - Do not consume at more than 50% of rated power

DRM 3 - Do not consume at more than 75% of rated power and source reactive power

DRM 4 - Increase power consumption (subject to constraints from other active DRMs)

DRM 5 - Do not generate power.

DRM 6 - Do not generate at more than 50% of rated power.

DRM 7 - Do not generate at more than 75% of rated power and sink reactive power.

DRM 8 - Increase power generation. (subject to constraints from other active DRMs)

Asserted by shorting pins		Inverter behavior (AU)	
REF GEN/0	COM LOAD/0	DRM 0 - Disconnect from grid	Charge/Discharge mode
DRM1/5	COM LOAD/0	DRM 1 - Do not consume power	
DRM2/6	COM LOAD/0	DRM 2 - Do not consume at more than 50% of rated power	Charge mode
DRM3/7	COM LOAD/0	DRM 3 - Do not consume at more than 75% of rated power	
DRM4/8	COM LOAD/0	DRM 4 - Increase power consumption	
DRM1/5	REF GEN/0	DRM 5 - Do not generate power	Discharge mode
DRM2/6	REF GEN/0	DRM 6 - Do not generate at more than 50% of rated power	
DRM3/7	REF GEN/0	DRM 7 - Do not generate at more than 75% of rated power	
DRM4/8	REF GEN/0	DRM 8 - Increase power generation	

- Conductor cross-section: 0.5 mm² (AWG20) ~ 0.2 mm². (AWG24)
- Outside diameter of cable: 3.5mm ~ 4.8mm
- Please refer to UL 2464 computer cable guideline

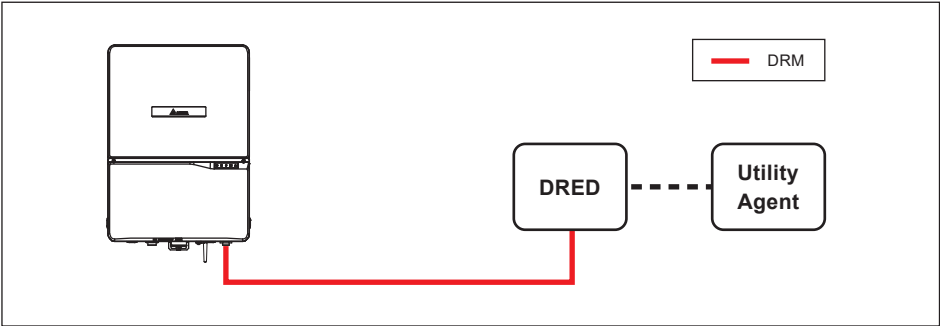

Figure 6-1 : Digital input

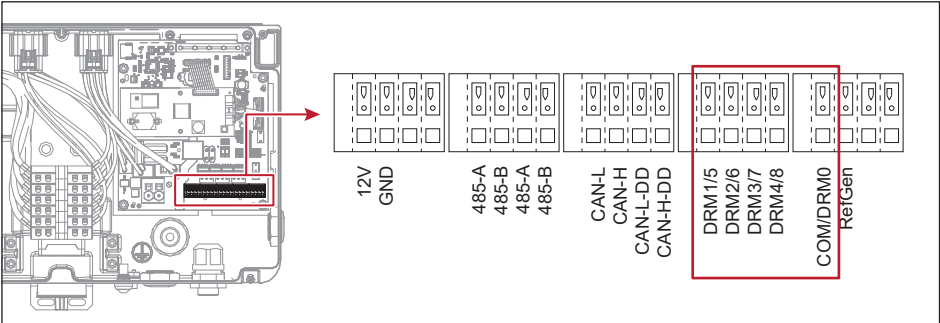

Figure 6-2 : Digital input on COMM. module

6.4 Power meter

Connecting the current sensor in the following steps:

1. Attach a current sensor to the L cables of the main earth leakage circuit breaker, Clamp the current sensor and make sure that the direction is correct.
2. Connect one end of the current sensor cable to the current sensor connection terminal and the other end to the Meter terminal in the junction box of inverter.

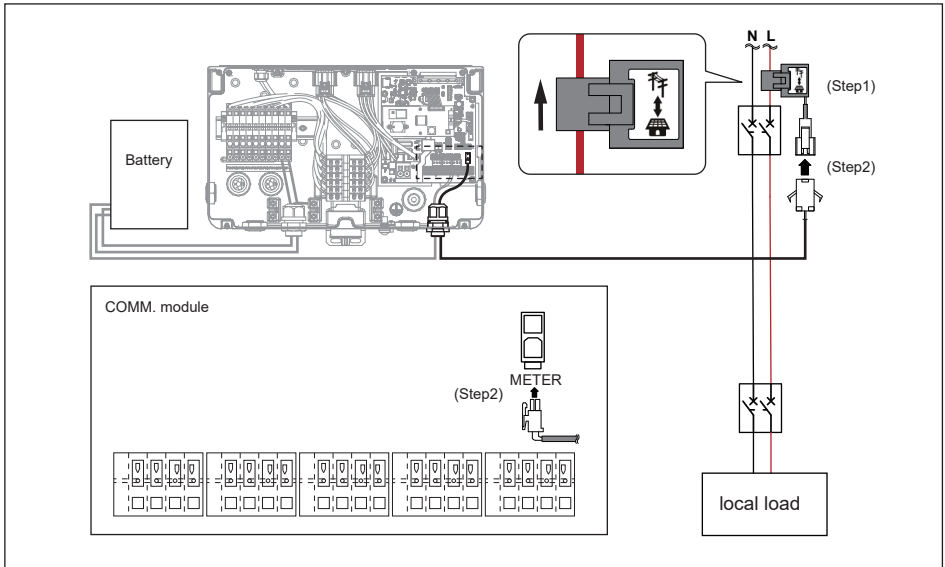

Figure 6-3 : Power meter

6.5 Operation Mode

The H8E / H10E hybrid system has 6 operation modes for users to choose and 2 passive operation modes. Each mode has different behavior between battery, grid, and home load. In some area, the detail behavior of each operation mode may be different due to the local electricity regulations.

6.5.1 Self-consumption mode

In this mode, the system is operated in following priority :

1. Charge the battery with the excess PV energy which feed-in to the grid until the battery is fully charged.
2. Discharge the battery when the PV energy is insufficient to provide the home load consumption until the battery is fully discharged.

When there is no PV power, battery starts to discharge and supply home load until it's empty. If the time setting function is enabled, the behavior of the system will according to the time setting in priority. The detail operation of battery control setting is described in **Chapter 6.5**.

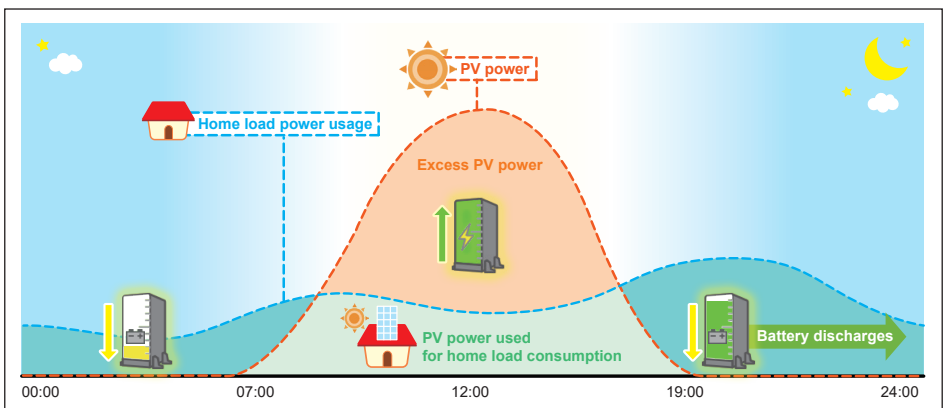
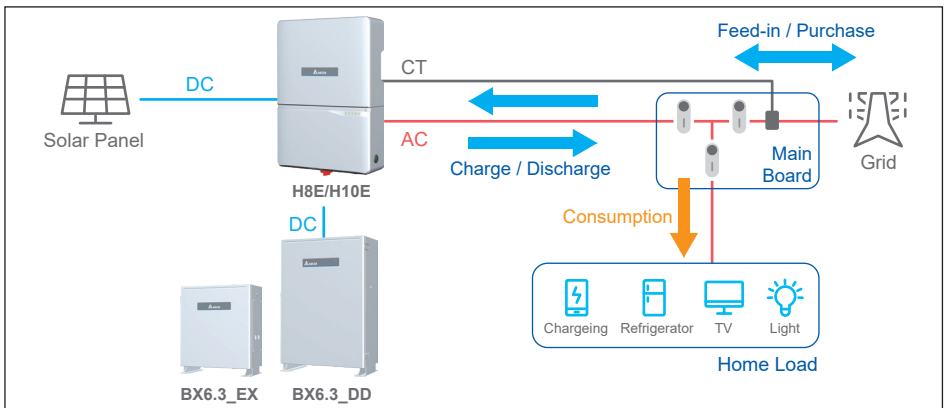

6.5.2 Peak cut mode

In this mode, the home load will consume the power from the PV inverter in priority. When the home load consume more power than the power generated by the inverter, it will consume the power from the grid. Then, battery will only discharged to the grid to supply the extra load after the power consume from the grid exceeds the “peak cut power” setting value. “Peak cut power” can be assigned in the Battery Control page.

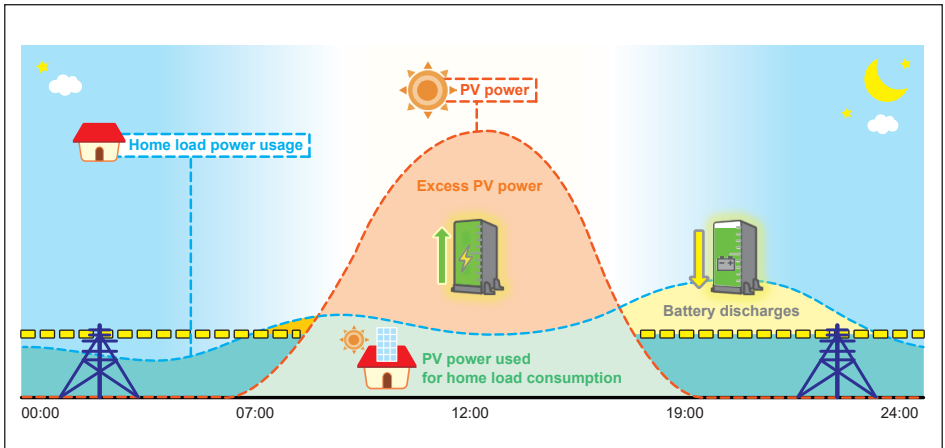
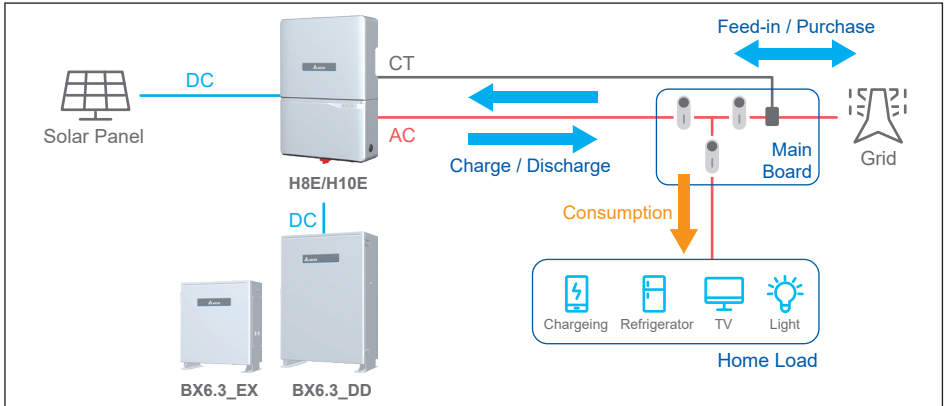

6.5.3 Selling first mode

Selling first mode is a standard mode combining with 6 time settings. In this mode, the system is operated in following priority:

1. If users have set the time settings, inverter will change behavior in these time intervals
2. Discharge the battery when purchased power from grid is detected until battery empty.

Please refer to **Chapter 6.5** for more detail about time settings.

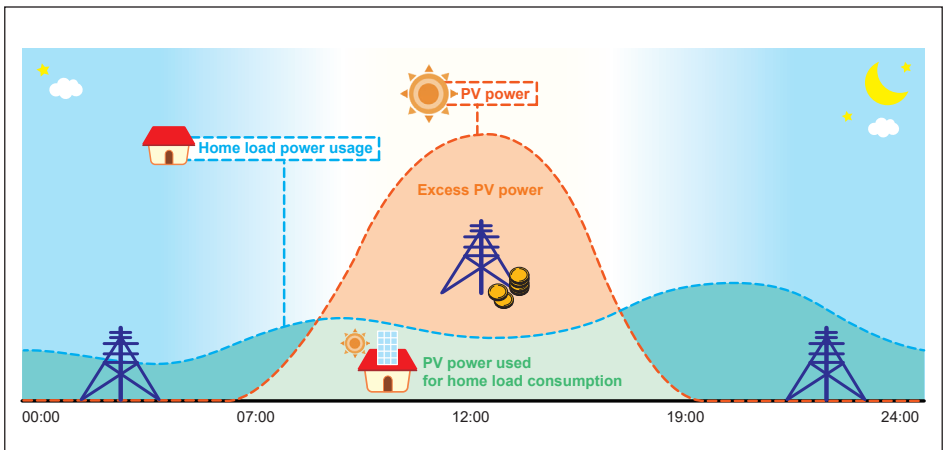
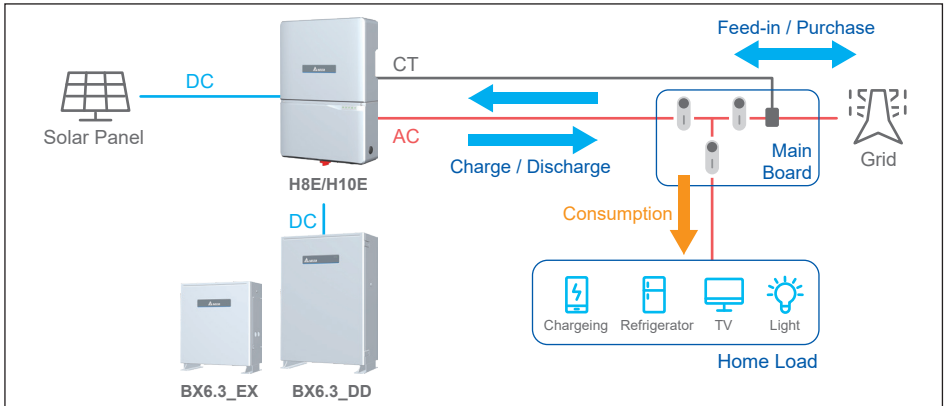

6.5.4 Charge first mode

In this mode, battery will be charged by PV or grid in priority, after battery is fully charged, the remaining PV power then feed-in to home load and grid. Battery will not be discharged in this mode even there is demand in the home load.

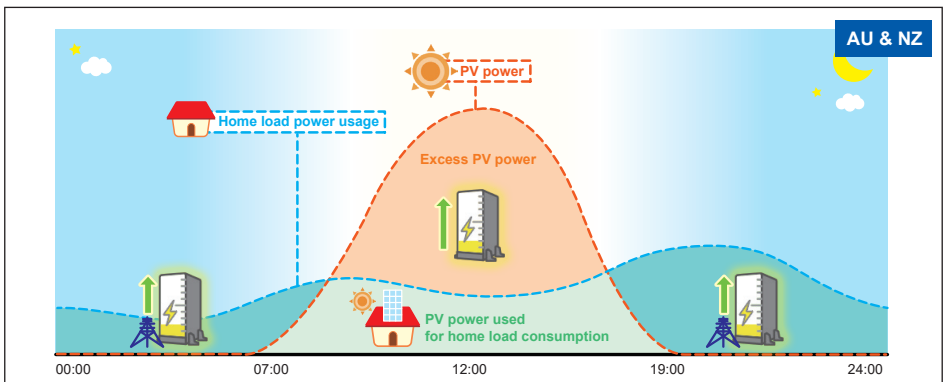
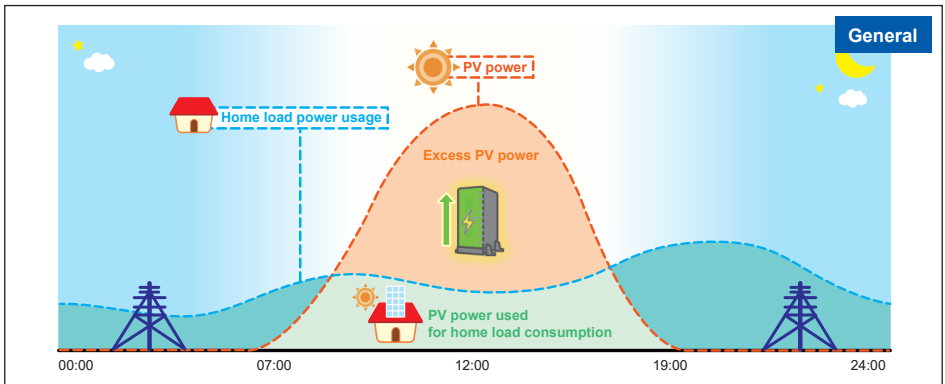
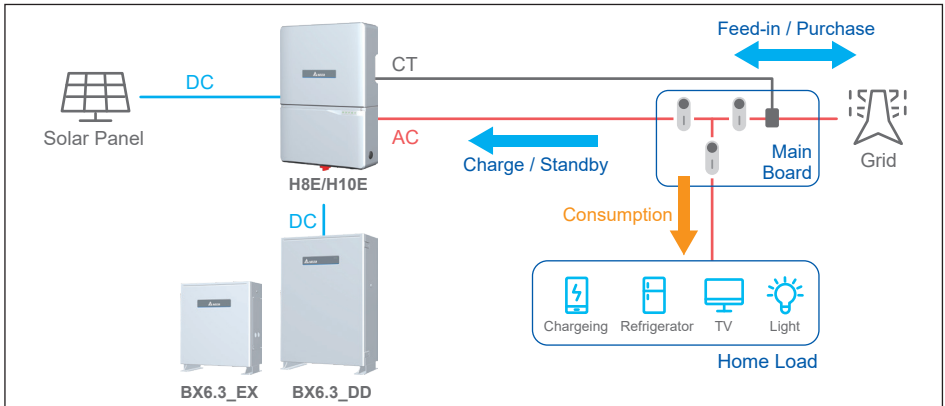

6.5.5 Discharge first mode

In this mode, the battery will only be discharged depends on the load consumption. It will not be charged even there is excess PV power. All the PV power is feed-in to home load and grid. Battery will keep discharging when there is demand in the home load until it fully discharged.

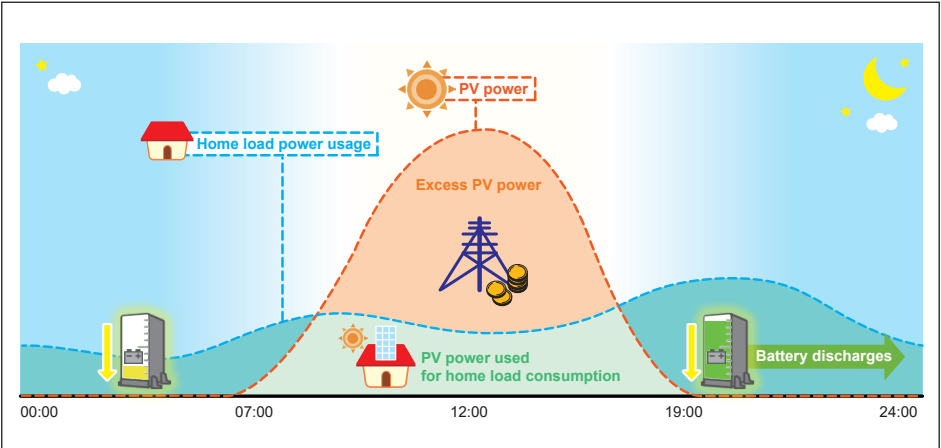
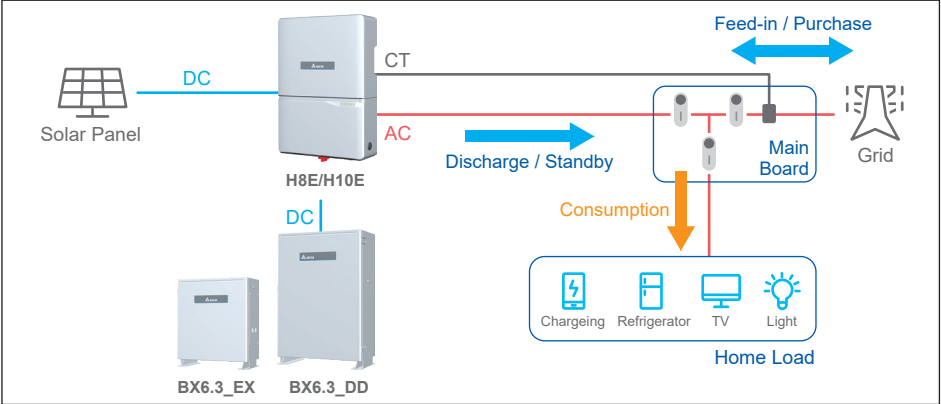

6.5.6 Standalone mode

Operation mode select 'Hybrid with backup charge - phase 2', the system changes to standalone mode automatically during a power outage occur. At this time, grid side is disconnected and hybrid inverter operate in micro-grid to provide simulated grid for home load and PV inverter. The detail configure application is described in **Chapter 7**.

6.5.7 Forced charge mode

Forced charge mode is passive mode. Although battery stops any action when SOC (State Of Charge) reach 0%, the self-discharge phenomenon may still causing SOC lower than 0%.

At this time, hybrid inverter will force battery charging from PV power and grid power until the battery SOC reaching SOC limit setting (default is 30%).

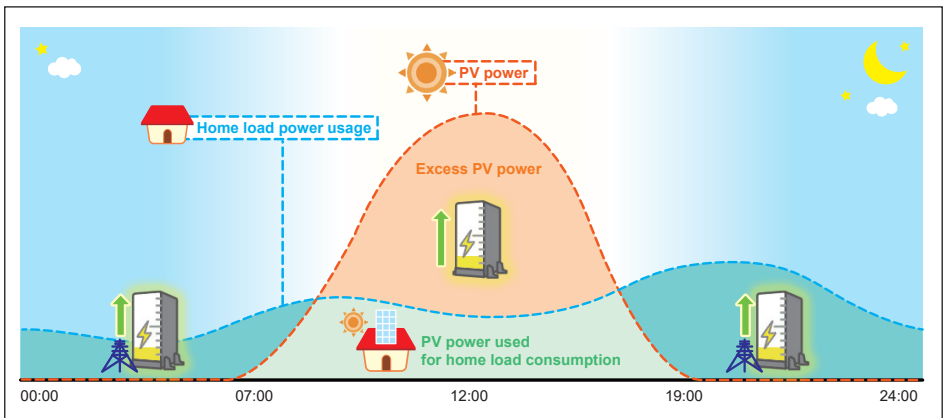
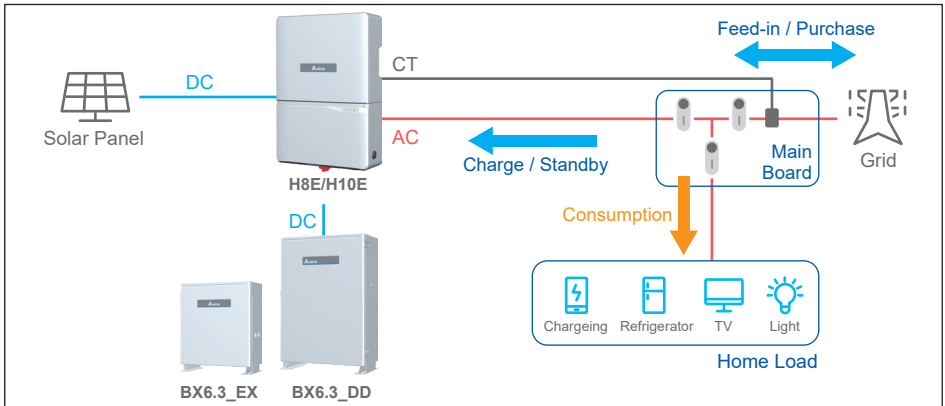

6.5.8 Balance mode

This operation is passive mode and only applied to H8E/H10E+BX6.3_DD+BX6.3_EX system. During the installation, the battery voltage of BX6.3 series might be different. Due to the specifications of the battery module, the system will be switched to this mode automatically to balance the voltage of BX6.3 series.

When the system is operating under this mode, the system will either discharge the battery with 3 kW power to the load and the grid or charge the battery with 2.5 kW power from the grid.

Once the battery voltage of BX6.3 series are balance, this balance mode will stop and the system will automatically be switched to the operational mode selected by the user.

6.6 Battery Control Setting

In battery control setting page, you can assign SOC limit, peak cut power, and BT charge / discharge time interval.

- **SOC Limit**

You can assign the lower limit of battery SOC. Battery will stop discharging when its SOC reach this limit.

- **Peak Cut Power**

Peak cut power is used in peak cut mode. You can assign the peak power of home load usage from grid. When the home load consumption exceeds this value, battery will discharge to supply remaining power.

- **Charge / Discharge Schedule**

This settings can be separated into BT charge time and BT discharge time.

Each setting has 3 time setting intervals. The time setting of all the intervals cannot overlap with each other.

The function is only available under self-consumption mode and selling first mode. Under either mode, Hybrid inverter will automatically switched to charge first / discharge first mode according to the charge/discharge schedule and switched back to the original mode when the time is out of the setting interval.

- **Main Supply Breaker Capacity**

Please set the current rating of the main supply breaker of the household. The system will refer to this setting to adjust its maximum charging power drawn from the grid during peak hours to avoid the unnecessary tripping of the breaker.

- **Time Schedule for SOH-cycle**

Once a year the battery must do a FULL un-interrupted discharge and re-charge cycle. This will be completed and undertaken at a scheduled day and time as set by the user. Should the temperature of the battery be below 20 degrees Celsius the battery will postpone the process for 3 months.

7 System application

1. PV only

The Delta hybrid inverter can be used purely as an inverter without a battery connected to it.

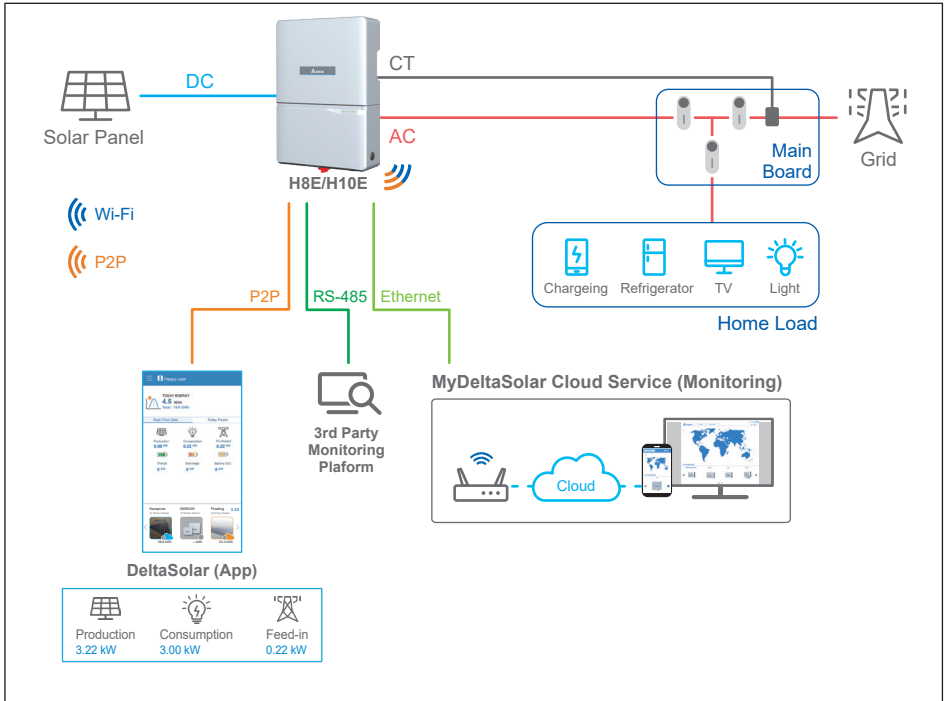

2. Hybrid

To optimise self-consumption in your PV system, you can use a battery as a storage system. In this system, the inverter can store the excess PV energy and provide energy to the load when the PV power is insufficient.

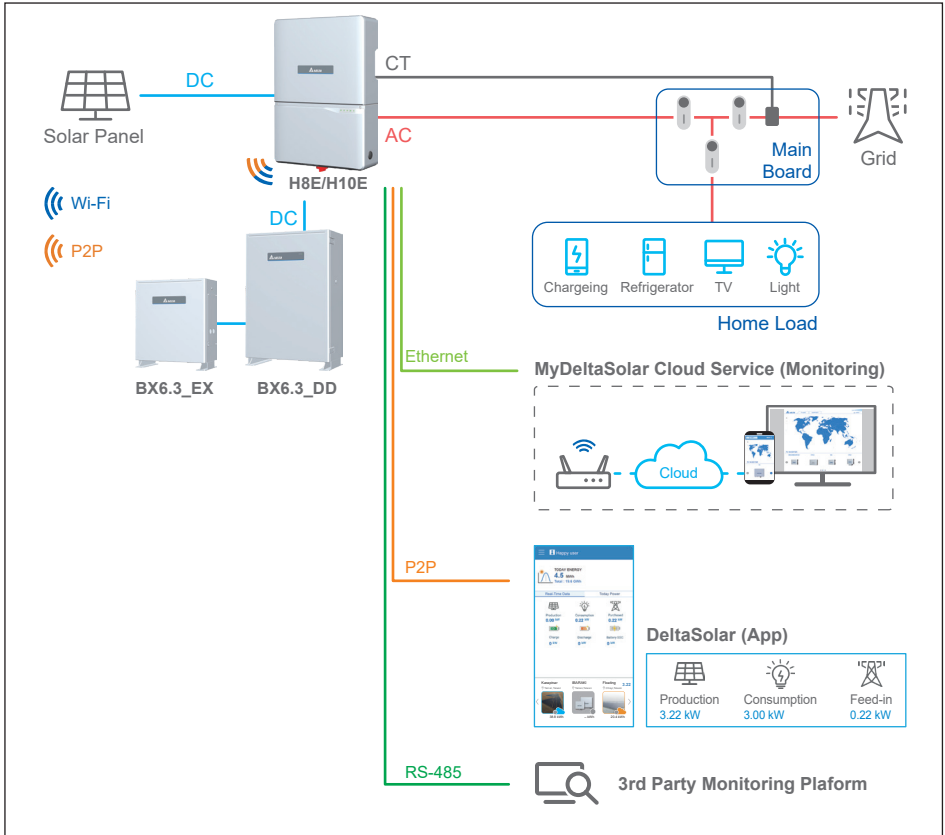

DANGER!



In general, you mustn't use the described system in backup power mode for life-support-systems or any other medical devices and systems. Backup power mode doesn't comply to the requirements for emergency power and isn't an uninterruptible power supply.

ATTENTION



Short circuit at the critical load may cause damage to the inverter in Hybrid with backup charge – phase 1

8 Turning the PV inverter on/off

For PV system with BX6.3_DD battery, when first operating, please operate under on-grid mode and turn on the AC power. The system can only run in off-grid mode once the internal configuration has been completed.

WARNING !

The internal temperature may exceed over 70°C while operating. To avoid injury, do not touch the surface of the inverter whilst the unit is in operation.



After installation, please ensure the AC, the DC and communication connection are correct. When enough power is generated from the PV array, the device will operate automatically and will initial 'self-test'. This self-test takes approximately 2 minutes and will occur at first start-up of the day.

DANGER!



When undertaking Battery wiring, please ensure that the BX6.3_DD system is shutdown.

8.1 Start-up Procedures

8.1.1 DC Voltage Checking

Firstly, uncover the PV arrays and expose them to full sunlight. Please note, the sunlight must be intense enough to produce the required output voltage for the inverter to start up.

Measure the PV array open circuit DC voltage across the DC positive (+) and negative (-) terminals.

8.1.2 AC Utility Voltage Checking

Using an AC voltmeter, measure the AC open circuit utility voltage between L1 (L) and L2 (N) Ensure the voltage is at approximately the nominal value. The inverter operates with a line-to-line voltage range around the nominal value.

Refer to **Chapter 12** output section for the utility voltage operating range for the inverter model.

8.1.3 Starting up the Inverter

1. Switch on the PV Array switch and DC switch (with DC switch model) to connect PV Array.
2. Switch on AC circuit breaker to connect electricity grid.
3. Communication Module (Wi-Fi or RS-485)
The Communication Module supports the communication with the device with Wi-Fi function.(e.g., smart phone, tablet ect.)

Wi-Fi communication

Please refer to the following website or scan the QR-code for Wi-Fi connection and APP operation guide.

<https://mydeltasolar.deltaww.com/index.php?p=manual>

*Note: While using APP to upgrade firmware, after upgrading successfully on APP, inverter need extra 10 minutes to complete internal update, please keep PV and AC on.



RS-485 connection

Please contact the local service center.

4. After connecting Wi-Fi, please use APP to select the correct country code per your installation location. Delta H10E/H8E supports “Australia A”, “Australia B”, “Australia C” and “New Zealand” per the latest standard of AS 4777.2-2020.

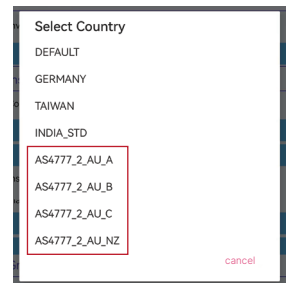

ATTENTION



To establish a successful communication between Inverter Wi-Fi to MyDeltaSolar Cloud, in the Wi-Fi connection setup page, the signal strength must be above -70dBm between each Wi-Fi device (Wi-Fi router, inverter, DC1...etc.). In case the signal strength is below -70dbm, it may cause certain communication errors which may prevent a successful Wi-Fi communication. To avoid such issues, please adjust the Wi-Fi device position to improve the signal strength/quality.

8.2 Shut down Procedures

1. Switch off AC circuit breaker to disconnect electricity grid.
2. Switch off the PV Array switch and DC switch to disconnect PV Array.

ATTENTION



Due to the variety of installation environments, installation of the unit and start-up procedures must be carried out by an accredited technician. Incorrect settings may cause the inverter to malfunction.

9 Maintenance

In order to ensure normal operation of the inverter, please check the unit regularly. Check that all terminals, screws and cables are connected and appear as they did upon installation. If there are any impaired or loose parts, please contact your solar installer immediately. Ensure that there are no foreign objects in the path of the heat outlet and keep the unit and it's surroundings clean and tidy at all times.

WARNING !



Before any maintenance, please switch AC and DC power off to avoid risk of electronic shock.

10 Error Message and Trouble Shooting

Table 10-1 : Error Message

Error		
Message	Possible cause	Action
E01: OFR	<ol style="list-style-type: none"> 1. Actual utility frequency is higher than the OFR setting 2. Incorrect country setting 3. Detection circuit malfunction 	<ol style="list-style-type: none"> 1. Check the utility frequency on the inverter terminal 2. Check country & Grid setting 3. Check the detection circuit inside the inverter
E02: UFR	<ol style="list-style-type: none"> 1. Actual utility frequency is lower than the UFR setting 2. Incorrect country or Grid setting 3. Detection circuit malfunction 	
E10: UVR	<ol style="list-style-type: none"> 1. Actual utility voltage is higher than the UVR setting 2. Incorrect country or Grid setting 3. Detection circuit malfunction 	<ol style="list-style-type: none"> 1. Measure the utility AC voltage to the inverter terminal. 2. Check country & Grid setting 3. Check the detection circuit inside the inverter
E11: OVR	<ol style="list-style-type: none"> 1. Actual utility voltage is higher than the OVR setting 2. Incorrect country or Grid setting 3. Detection circuit malfunction 	
E30: OVR(PV)	<ol style="list-style-type: none"> 1. Actual Solar voltage is over 540Vdc 2. Detection circuit malfunction 	<ol style="list-style-type: none"> 1. Modify the solar array configuration and make the Voc less than 540Vdc 2. Check the detection circuit inside the inverter
E34: Insulation	<ol style="list-style-type: none"> 1. PV array insulation fault 2. Large PV array capacitance between Plus to Ground or Minus to Ground or both. 3. Detection circuit malfunction 	<ol style="list-style-type: none"> 1. Check the insulation of Solar inputs 2. Check the capacitance, dry PV panel if necessary 3. Check the detection circuit inside the inverter

Table 10-2 : Fault Message

Error		
Message	Possible cause	Action
F05: NTC OTP	1. The ambient temp. is over 65°C 2. Detection circuit malfunction	1. Check the installation ambient temperature and environment 2. Check the detection circuit inside the inverter
F06: NTC0 Circuit Fail	1. Ambient temp. >130°C or <-45°C 2. Detection circuit malfunction	
F05: NTC OTP	1. Ambient temp. <-30°C 2. Detection circuit malfunction	
F14: Firmware Incompatibility	There are conflicts between software versions of controllers	Check the firmware on by app or cloud, update to latest version.
F15: HW ADC1(DAC)	1. Auxiliary power circuitry malfunction 2. Detection circuit malfunction	1. Check the auxiliary circuitry inside the inverter 2. Check the detection circuit inside the inverter
F16: HW ADC2 (INT CONF)	1. Auxiliary power circuitry malfunction 2. Memory device malfunction	1. Check the auxiliary circuitry inside the inverter 2. Check the memory device inside the inverter
F23: Comm. Fault (Dis.)	1. The communication connection is disconnected 2. The communication circuit malfunction	1. Check the connection between power head and system board 2. Check the communication circuit
F24: Residual Current Over Rating	1. PV array insulation fault 2. Large PV array capacitance between Plus to Ground or Minus to Ground 3. Either side of boost driver or boost choke malfunction 4. Detection circuit malfunction	1. Check the insulation of Solar inputs 2. Check the capacitance (+ <-> GND & - <-> GND), must < 2.5Uf. Install an external transformer if necessary 3. Check boost driver & boost choke 4. Check the detection circuit inside the inverter
F27: Residual Current Self-test Circuit Fail	Detection circuit malfunction	Do power cycle, and check the detection circuit inside the inverter.
F28: Relay Test Fail	1. One or more relays are sticking 2. The driver circuit for the relay malfunction	1. Replace the defective relay(s) 2. Check the driver circuit inside the inverter
F31:Bus Over Voltage SW	1. Driver for boost is defective 2. Voc of PV array is over 550Vdc 3. Detection circuit malfunction	1. Check the driver circuit for boost inside the inverter 2. Modify the solar array setting, and make the Voc less than 540Vdc 3. Check the detection circuit inside the inverter
F32:Bus Under Voltage SW	1. PV or battery can't support enough power for inverter 2. Detection circuit malfunction	1. Do power cycle, and check battery 2. Check the detection circuit inside the inverter

Error		
Message	Possible cause	Action
F35: Bus Over Voltage HW	<ol style="list-style-type: none"> 1. Driver for boost is defective 2. Voc of PV array is over 550Vdc 3. Surge occurs during operation 4. Detection circuit malfunction 	<ol style="list-style-type: none"> 1. Check the driver circuit for boost inside the inverter 2. Modify the solar array setting, and make the Voc less than 540Vdc 3. N/A 4. Check the detection circuit inside the inverter
F36: Inverter OCP HW	<ol style="list-style-type: none"> 1. Driver for inverter is defective 2. Detection circuit malfunction 	
F48: Over Load (Standalone)	Load power exceed rating power	Check load power, remove load.
F50: PLL Fail	<ol style="list-style-type: none"> 1. The DC component in grid voltage is too large. 2. Incorrect country or Grid setting 	<ol style="list-style-type: none"> 1. Measure DC component of grid voltage, using multi meter 2. check if Check country & Grid setting
F57: Aux-Power Fail	<ol style="list-style-type: none"> 1. Auxiliary power circuitry malfunction 2. DSP ADC sample malfunction 	<ol style="list-style-type: none"> 1. Check the auxiliary power circuit inside the inverter 2. Check sampling circuit inside the inverter
F60: IOCP(PV1)	<ol style="list-style-type: none"> 1. Switching device in boost is defective 2. Driver for boost is defective 3. Input current detection circuit malfunction 	<ol style="list-style-type: none"> 1. Check all switching device in boost 2. Check the driver circuit for boost inside the inverter 3. Check input current detection circuit
F61: IOCP(PV2)		
F62: IOCP(PV3)		
F63: IOCP(PV4)		
F77: CT sensor Fail	<ol style="list-style-type: none"> 1. Inverter choke Fail 2. Output Filter Fail 3. Detection circuit malfunction 	<ol style="list-style-type: none"> 1. Check Inverter choke inductance. 2. Check output filter capacitance. 3. Check the detection circuit inside the inverter

11 De-Commissioning

If necessary to put the device out of operation for maintenance and/or storage, please follow the instructions below.

WARNING !



To avoid injuries, please follow this procedures

1. Switch off AC circuit breaker to disconnect from electricity grid.
2. Switch off the PV Array switch to disconnect from PV Array.
3. Push EPO button and check the Bx6.3DD_system is shutdown.
4. Use proper voltage meter to confirm that the AC and DC power are disconnected from the unit.
5. Remove the AC wiring immediately to completely disconnect from electricity grid.
6. Remove the DC wiring to disconnect from PV Array.
7. After completing all of the above steps, the inverter can be removed.

12 Technical Data

Model	H8E	H10E
DC INPUT (Solar side)		
Max. input voltage	600 V	
Nominal voltage	380 V	
Max. operating voltage	540 V	
Start-up voltage	50 V	
Operating MPPT voltage range	50 V - 480 V	
Full power MPPT voltage range	280 V - 480 V	
Max. input current / MPPT	12 A	
Max. short circuit current / MPPT	20 A	
Max. DC/AC ratio ¹	1.3	
DC disconnect	Integrated	
MPP tracker	4	
AFCI	Type 1 (UL1699B)	
Max. inverter backfeed current to the Array	0 A	
AC OUTPUT (GRID-TIED)		
Rated continuous power @ 230Vac	7360 W	9200 W
Rated continuous power @ 240Vac	7680 W	9600 W
Max. apparent power @ 250Vac	8000 VA	10000 VA
Rated apparent Power	7360 VA	9200 VA
Nominal voltage	230 V / 240 V	
Max. / rated continuous current	32 A	40 A
Max. power export to Grid	5000 VA ²	
Max. current export to Grid	21.7A	
Nominal operating frequency	50 Hz	
Night consumption	< 1.5 W ³	
THD @ nominal power	< 3 %	
Adjustable power factor range	0.8 ind - 0.8 cap	
Inrush current	25.6 Apk, 1ms	
Maximum overcurrent protection	40 A	50 A

Model	H8E	H10E
AC OUTPUT (Standalone)		
Nominal voltage	230 V / 240 V	
Max. continuous current	32 A	40 A
Max. continuous power	8 KVA(Linear load)/6.4 KVA(RCD Load)	10 KVA(Linear load)/8 KVA(RCD Load)
Nominal operating frequency	50 Hz	
Battery terminal parameters		
Nominal voltage	540 V	
Range of DC charging voltage	350 V - 540 V	
Range of DC discharging voltage	350 V - 540 V	
Max. charging current	20 A	
Max. charging power	6000 VA	
Max. discharging current	20 A	
Max. discharging power	6000 VA	
Storage type	Lithium	
GENERAL SPECIFICATION		
Max. efficiency	98.0 %	
EU efficiency	97.3 %	
Operating Temp. range	-25 °C to 65 °C (derating above 45 °C)	
Storage Temp. range	-40 °C to 85 °C	
Humidity	0% to 95%	
Max. operating altitude	9,843 ft (3,000 m)	
Acoustic noise	< 45 dB(A) @ 3 ft (1m)	
Communication interface	WiFi, optional BLE, Ethernet, 3G / 4G cellular communication	
Inverter Topology	Non-isolated	
Active anti-islanding method	Reactive power variation ⁴ , Comply with IEC 62116	
Residual Current Device (RCD)	integrated ⁵	
Protective class	Class I	
Over voltage category	OVC II (PV) and OVC III (mains)	

Model	H8E	H10E
MECHANICAL DESIGN		
Dimensions (W x H x D)	425 x 590 x 160 mm	
Display	LED indicators	
Weight	21.6 kg	
Cooling	Natural convection	
STANDARDS		
Enclosure protection rating	IP 65	
Safety	IEC 62109-1/-2, IEC 62040	
EMC	EN 61000	
Grid support regulation	AS/NZS 4777.2:2020	
WARRANTY AND OTHERS		
Standard warranty	5 years, optional 10 years	
Country of manufacturer	Taiwan	

- 1) The DC/AC ratio is defined as the ratio between STC power rating of the connected PV array and rated AC continuous output power @230Vac that can be delivered by a given inverter.
- 2) The export limit of 5KVA is achieved by software if CT is installed.
- 3) Without consumption of WiFi communication
- 4) Periodically inject reactive power variation to grid
- 5) This inverter includes an integrated residual current device (RCD). If an external residual current device (RCD) is used, a device of Type A should be used, with tripping current of 30mA.

Trip limit and trip time accuracy for all models	
Voltage	±1% (L-L)
Frequency	±0.01Hz
Time	1%, but not less than 100ms

