



The power behind competitiveness

Delta Data Collector

PPM DC1_100

Installation Manual

Contents

■ Introduction ■

Precautions for Your Safety	03
Essential Points for Safety	04
Precautions for Use	04
Product Overview	05
1. Preparation before construction	06
1.1.Scope of Delivery	06
1.2.Dimension	07
1.3.Descriptions and Functions of Parts and Components	08
1.4.Reset Method	09
1.5.Description of Functional Pins	09
2. Installation	10
2.1.Installation on wall	10
2.2.Installation in box (outdoor)	10
2.3.Connection to the inverter	11
2.4.Download the APP	12
3. System application	13
3.1.Normal mode	13
3.2.Retrofit mode	15
3.3. 3rd party monitoring - Modbus tcp/ip	16
3.4. 3rd party monitoring - Modbus RTU (Forward mode)	17
4. Specifications	19
5. When Something Seems Wrong (Troubleshooting)	20
5.1.Error Displays	20
5.2.Troubleshooting	21
Appendix - PPM P1_120	22
Appendix - PPM P3_120	23



Precautions for Your Safety

■ Notations for safe use of the product and their meanings





This Instruction Manual provides precautions with the following notations and symbols for safe use of the PPM DC1_100. The expression “Product”, “Data Collector” or “DC1” refers to the PPM DC1_100. Precautions described herein contain important aspects of safety.







Please observe and follow these descriptions.

Notations and symbols are described below:





 Warning	Failing to handle the Product properly may result in the described danger leading to slight or intermediate level injuries and in some cases may also result in serious injury or death.
 Caution	Failing to handle the Product properly may result in the described danger leading to slight or intermediate level injuries or property damages in some instances.

■ Explanation of graphic symbols

	<ul style="list-style-type: none"> • Electric Shock Precaution Notifications pertaining to precautions for potential electric shock, under specific conditions
	<ul style="list-style-type: none"> • General Unspecified general notifications pertaining to prohibited actions.
	<ul style="list-style-type: none"> • Disassembly prohibited Notifications pertaining to prohibition of equipment disassembly, when doing so can potentially lead to injuries such as electric shock.
	<ul style="list-style-type: none"> • General Unspecified general notifications pertaining to instructions for users

 Warning	
Do not allow any fire producing objects to be near the Product, or apply any spray, including combustible gases, to the Product. The Product may ignite or explode in the unlikely event such an occurrence takes place.	
Do not touch the Product with wet hands. The Product may cause injury due to electric shock or equipment malfunction may occur in the unlikely event such an occurrence takes place.	
Do not disassemble or modify the Product. The Product may cause injury or fire due to electric shock in the unlikely event such an occurrence takes place.	
When wiring the power meter, make sure to turn OFF the breakers connected to the power meter. Although small, there is a risk of electric shock.	
When installing the DC1, make sure to turn OFF all solar generator breakers and direct current switches for the inverter. Although small, there is a risk of electric shock.	

Caution

Do not install the Product in a place that is subject to significant effects of vibration and impact. There is danger of injury from the Product falling in some rare cases.	
Do not use organic solvents (paint thinners, benzene and the like), strong alkaline substances or strong acidic substances to clean the case of the product. There is danger of discoloring the case or the equipment malfunctioning in some rare cases.	
When installing the DC1 on a wall made of materials that are not wood, be sure to acquire plastic anchors available on the market to secure the Wall Surface Mounting Plate on the wall surface. There is danger of injury from the Product falling in some rare cases.	
Securely tighten the screws using a torque of 0.98 N.m. Although small, there is a risk of burns due to defective connections. Do not tighten the wiring using electric tools (drills), whose main purpose is to open holes, such as impact drivers, etc.	
Do not install the Product in the following types of locations: There is danger of burnout in some rare cases. <ul style="list-style-type: none">• Locations that are exposed to rain water, such as outdoors or under eaves and the like.• Locations that are exposed to steam or where the moisture level is 30 to 85% RH, such as lavatories, changing rooms, work sites, kitchens and the like.	

Essential Points for Safety

Items described below must be followed as they are necessary to secure safety.

- Request a specialist to dispose of the product.
- Pull 16-pin terminal and Power supply terminal off when any abnormality is detected like smoke, heat.
- Install the product with the “DELTA” logo facing front when installing the Data Collector on a wall.
- Take care to ensure no water or other liquid gets on the Data Collector.
- The product may malfunction or may be damaged by static electricity. Be sure to remove any static electricity on the body, through such means as touching a metal object nearby, prior to coming into contact with the product.
- Do not connect a telephone line to the LAN terminal on the Data Collector, make sure Ethernet cable is used.
- Store the product in a location with the temperature ranging between -30 and +70°C, with the humidity ranging from 30 to 85% RH.
- Max. 32 inverters can be monitored through RS-485 at one time.
Max. 9 inverters can be monitored through Wi-Fi at one time.

Do not install the product in the following places:

- Do not expose to extreme fluctuation temperature.
- Do not expose to salt air.
- Do not expose to corrosive substances, explosive / flammable GAS, chemicals.
- Do not install in direct sunlight.
- Do not install in a place exceeding the operating temperature range (-25 to +55°C).
- Do not install above 2000m MSL or higher.
- Do not expose to water vapor, oil vapor, smoke, cotton dust, metal powder, sawdust.

※If installed outdoor, please put it in box which is suitable for outdoor use.

Precautions for Use

- The Product may malfunction or may be damaged by static electricity. Be sure to remove any static electricity on the body, through such means as touching a metal object nearby, prior to coming into contact with the Product.
- Store the Product in a location with the temperature ranging between -20 and +55°C, with the humidity ranging from 30 to 85% RH.
- The Product communicates wirelessly.
Install the Product as far away as possible from devices that emit strong radio waves, such as a civil band radio equipment.
- The communication performance varies depending on the peripheral environment. Verify in advance that the Product is communicating normally when installing the Data Collector on a wall.
- Avoid installing the Data Collector near iron plate or steel reinforcements and try to install the Product with as much clear space as possible.

Product Overview

DC1 data collector is designed for monitoring PV inverter and conducting partial / zero export application to ensure solar power will feed in base on power company requirement. With its wired and wireless communication interface, DC1 can be connected to either MyDeltaSolar or 3rd party cloud service to realize remote management and optimize the efficiency of the PV system.

■ Features

- Partial / Zero export for grid protection
- DeltaSolar APP for inverter monitoring and control
- MyDeltaSolar cloud service or 3rd party platform compatible
- 7 days local data storage prevents data loss
- Wi-Fi, Ethernet and RS-485 communication interface

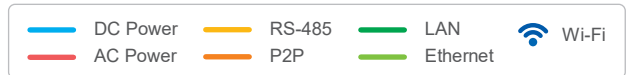

* Only one communication protocol (LAN, Ethernet, Wi-Fi) can be used at the same time.



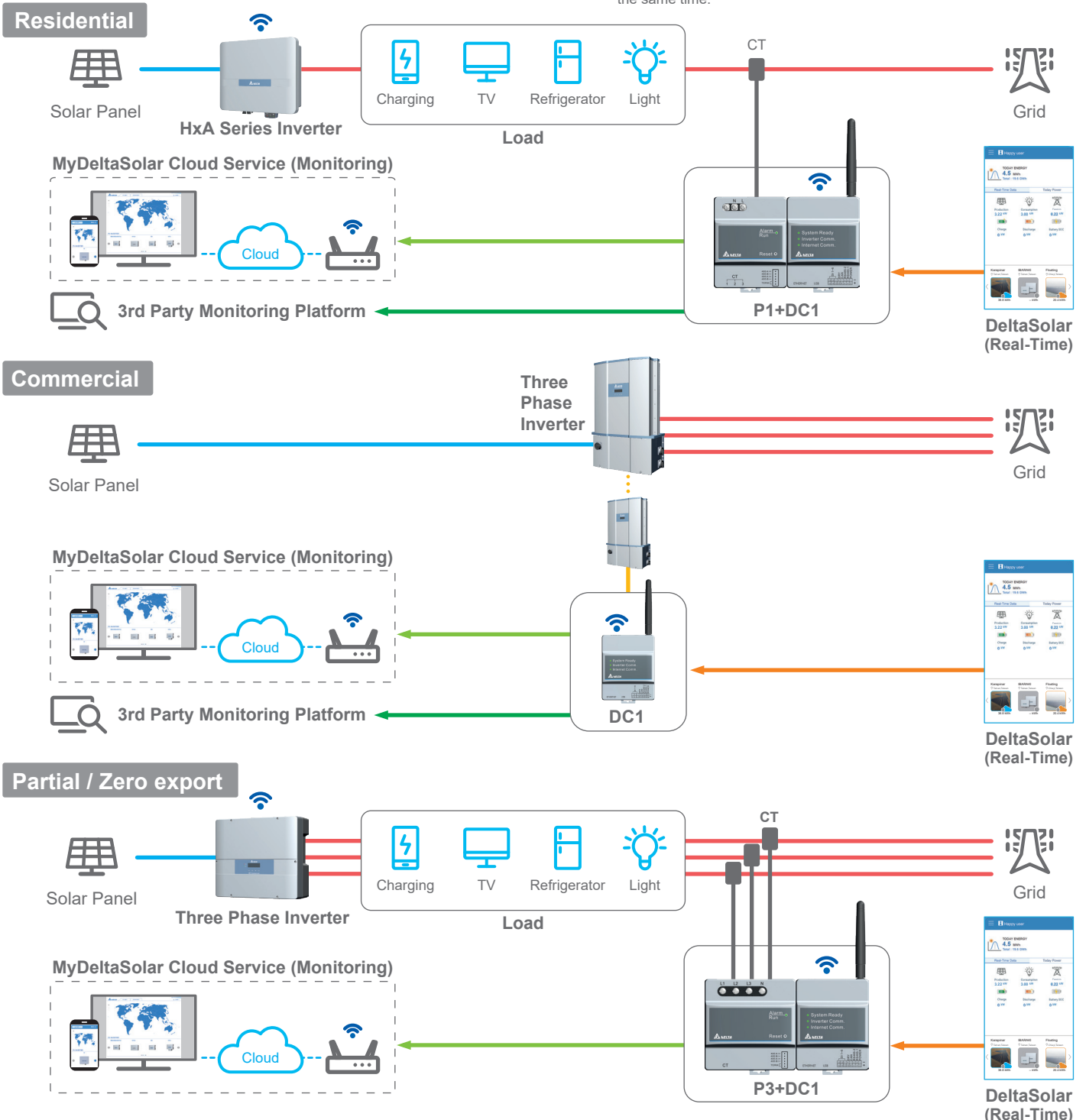



■ System Architecture

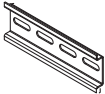

1 .Preparation before construction

1.1.Scope of Delivery

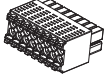
Verify that following items are available for use prior to using this feature.

NO.	Product name	Qty	Remarks	Shape
1	Data Collector	1 unit	Main unit	
2	Wi-Fi Antenna	1 piece	Install antenna to Enhance Wireless Signals.	
3	DIN Rail	1 piece	This is a rail used to install the product on a wall.	
4	DIN Rail Screw (PH2)	3 pieces	These are wood screws for the Wall Surface.	
5	16-pin Connector	1 piece	Connect to the main unit.	
6	DIN Rail Stopper	2 pieces	Stoppers to secure the installation of Data Collector on a DIN Rail.	
7	Quick Installation Guide	1 copy	Installation Guide	

1.2.Dimension

DC1

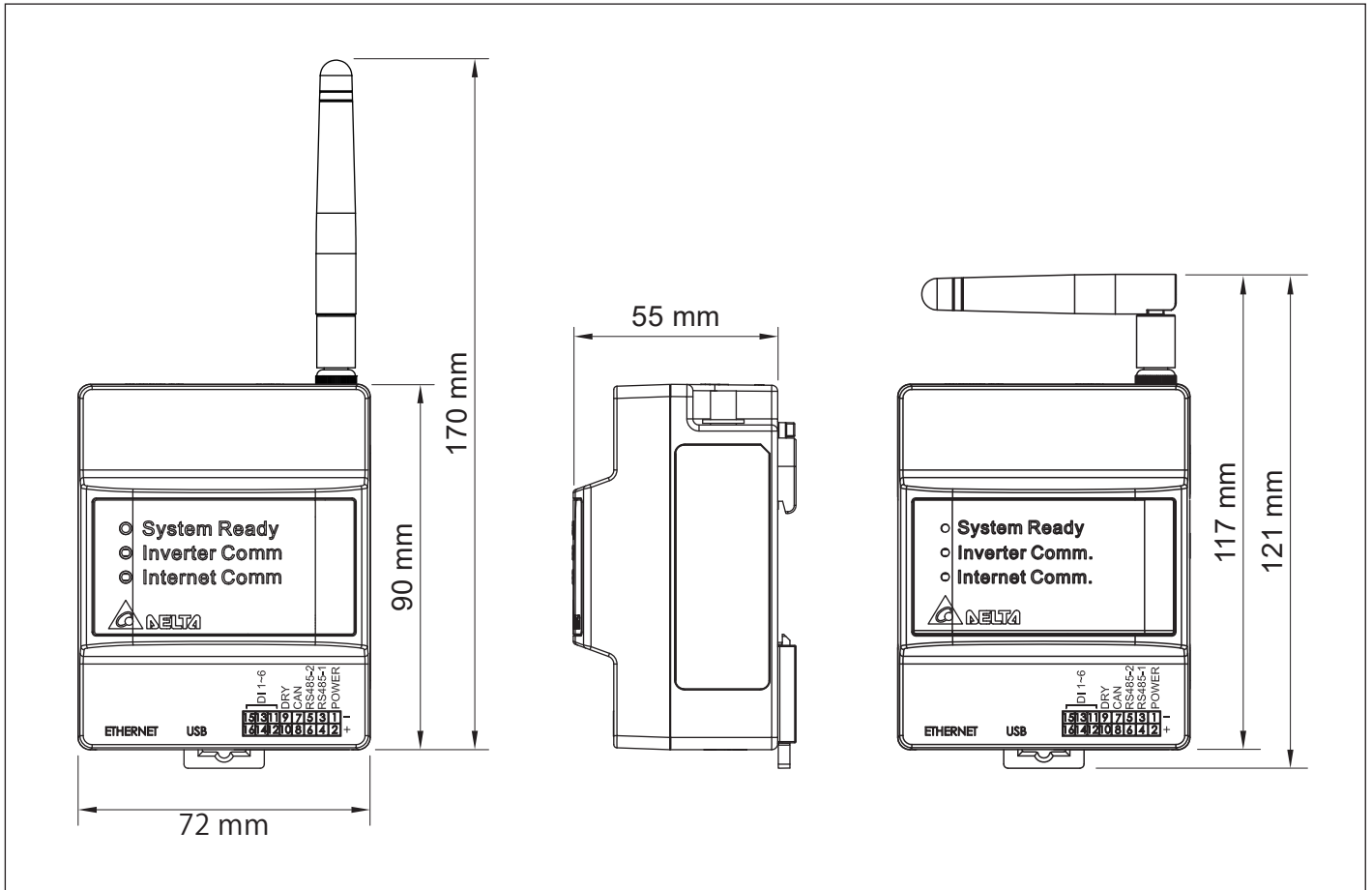

Din Rail

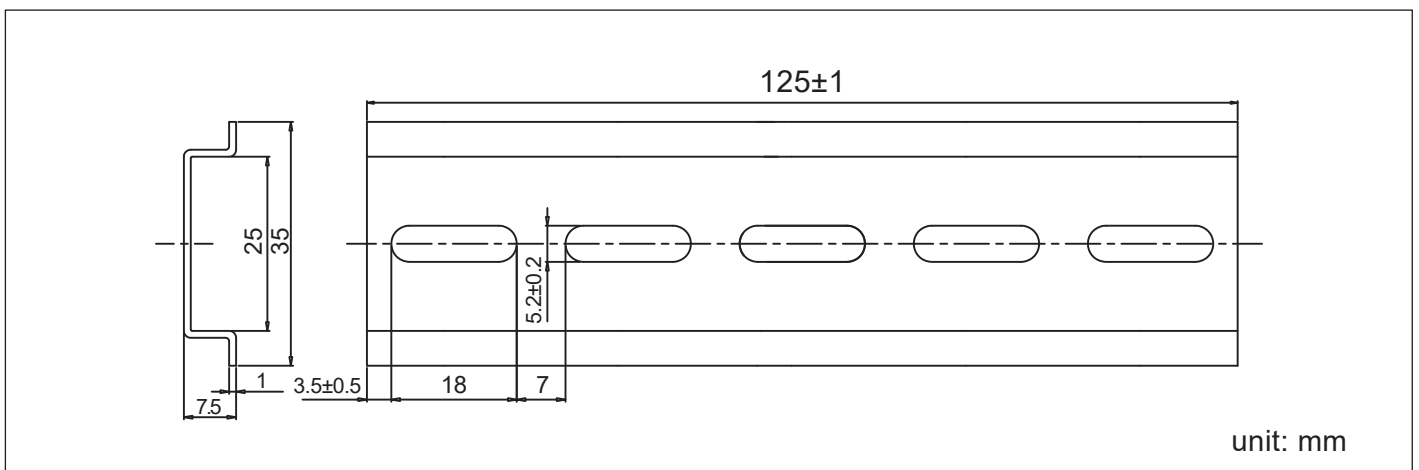

1.3. Descriptions and Functions of Parts and Components

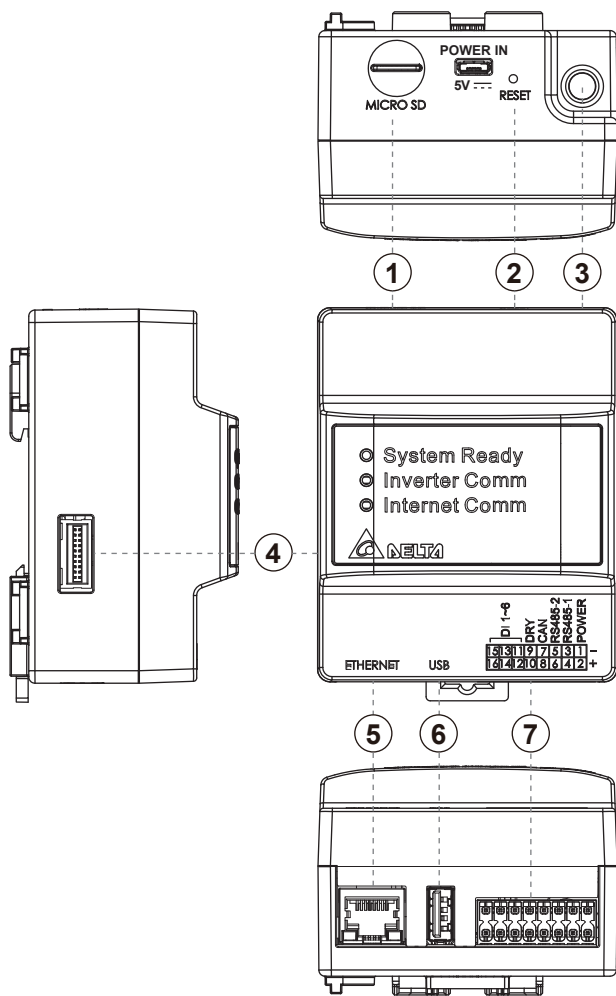

- ① MICRO SD
Use SD card to reset Data Collector to factory default.
The settings and records will be deleted.
- ② Reset button
Resetting the Data Collector. Restart the Data Collector.
The settings and records will not be deleted.
- ③ Wi-Fi antenna
Install antenna to Enhance Wireless Signals.
- ④ Extend terminal
It is also possible to expand the matching Power Meter for measurement.
- ⑤ LAN terminal (RJ-45 terminal)
This is the terminal that is used to connect the system to an ethernet cable.
- ⑥ USB terminal (for USB)
Reserve of various data and maintenance can be performed.
* Customers are requested to procure their own USB memory.
- ⑦ RS-485 (a 16-pin terminal)
This is the terminal that is used to connect a 16-pin connector provided, to link the supply of power and signals from the Inverter.

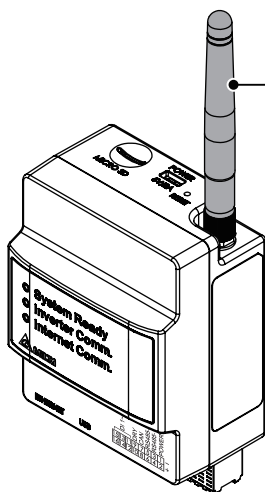

Wi-Fi Module

Name	Explanation
Network standard support	IEEE 802.11 b/g/n
Data rates	802.11n 6.5Mbps to 150Mbps (MCS 0-7)
	802.11g 6Mbps to 54Mbps
	802.11b 1Mbps to 11Mbps
Modulation techniques	OFDM with BPSK, QPSK, 16-QAM, 64-QAM
	802.11b with CCK and DSSS
Bandwidth	20MHz/ 40MHz



LED Explanation

Name	LED	Explanation
System Ready	Red	Booting.
	Green	System ready.
Inverter Comm	Green (blinking ON 1s / OFF 1s)	Inverter connected.
Internet Comm	Green	Network connected
	No light	Network not connected
	Green (blinking ON 1.5s / OFF 1.5s)	APP connection status
	Green (blinking ON 3s / OFF 3s)	Cloud connection status

1.4.Reset Method

TOP VIEW

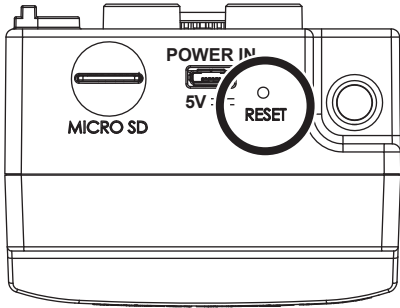

Press reset button	System ready led flashing	Action of DC1
3~5 sec	0.5sec ON, 0.5sec OFF	Rebuild wifi module
6~10 sec	1sec ON, 1sec OFF	Reset wifi password and rebuild wifi module
Over 15sec	2sec ON, 2sec OFF	Reset DC1 setting without SN, then reboot

1.5.Description of Functional Pins

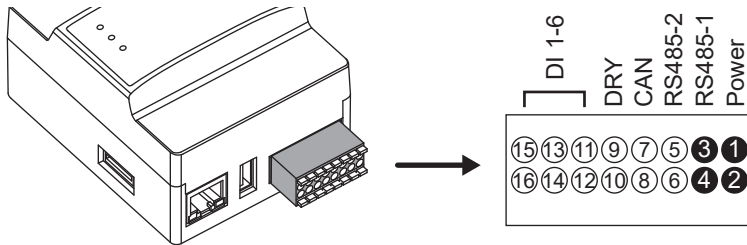

Definition of general Pins

Pins	Description
1	Power Input GND
2	Power Input +
3	RS485 1 - B (communication with inverters)
4	RS485 1 - A (communication with inverters)
5	RS485 2 - B (forward mode function)
6	RS485 2 - A (forward mode function)
7	N/A
8	N/A
9	Dry Contact*
10	Dry Contact*
11-16	Digital Input (DI 1 - 6)

Definition of Digital Input (DI 1-6)

Short Pins	System Behavior (Standard)	System Behavior (Australia)
16&15	N/A	Emergency power off (EPO)
16&14	Power de-rating to 30%	Power de-rating to 75%
16&13	Power de-rating to 0%	Power de-rating to 100%
16&12	Power de-rating to 100%	Power de-rating to 50%
16&11	Power de-rating to 60%	Power de-rating to 0%

*Dry Contact can support operating condition up to 24Vdc/0.3A

2. Installation

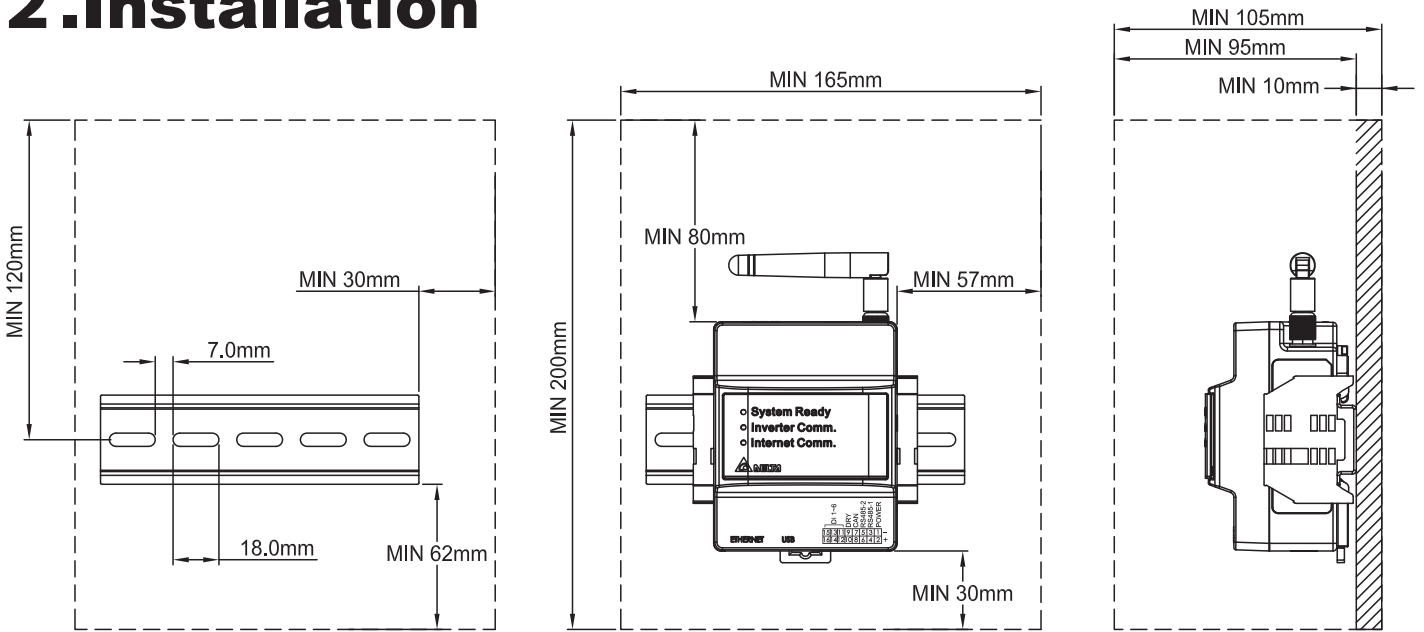

2.1. Installation on wall

- (1) Use the supplied DIN Rail and mount in distribution cabinet (A).
- (2) Fix the Data Collector on top of the DIN Rail.(B)
- (3) Buckle the Data Collector on the DIN Rail.(C)
- (4) Install two stoppers on the DIN Rail on both side of the Data Collector, then lock in the screws on stoppers to fix these stoppers on the DIN Rail.(D)

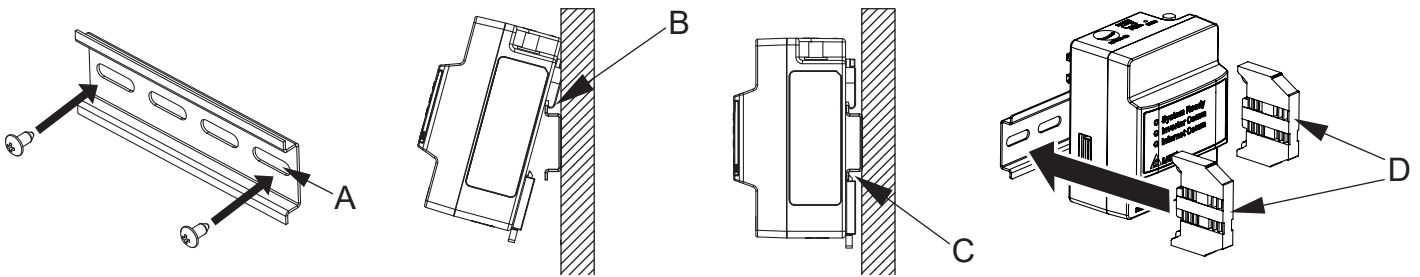

2.2. Installation in box (outdoor)

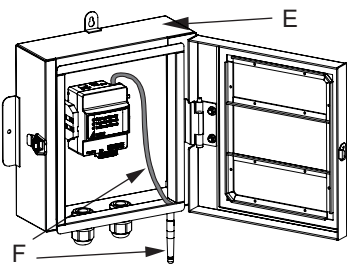

- (1) Please prepare a protective case to protect Data Collector (E).
 - * If the external box is made of plastic material, Wi-Fi antenna can be installed in the box.
 - * If the external box is made of metal, Wi-Fi antenna needs to be installed outside the box (F). User needs to use extension cable to connect the Wi-Fi antenna.
- (2) An external box is available for customer from Delta. Contact retailer for more details.

2.3.Connection to the inverter

(1) Prepare 0.3 to 0.5mm² single wire, 4 cores (twin wires) shielded cables (rated temperature: 80°C to 85°C).

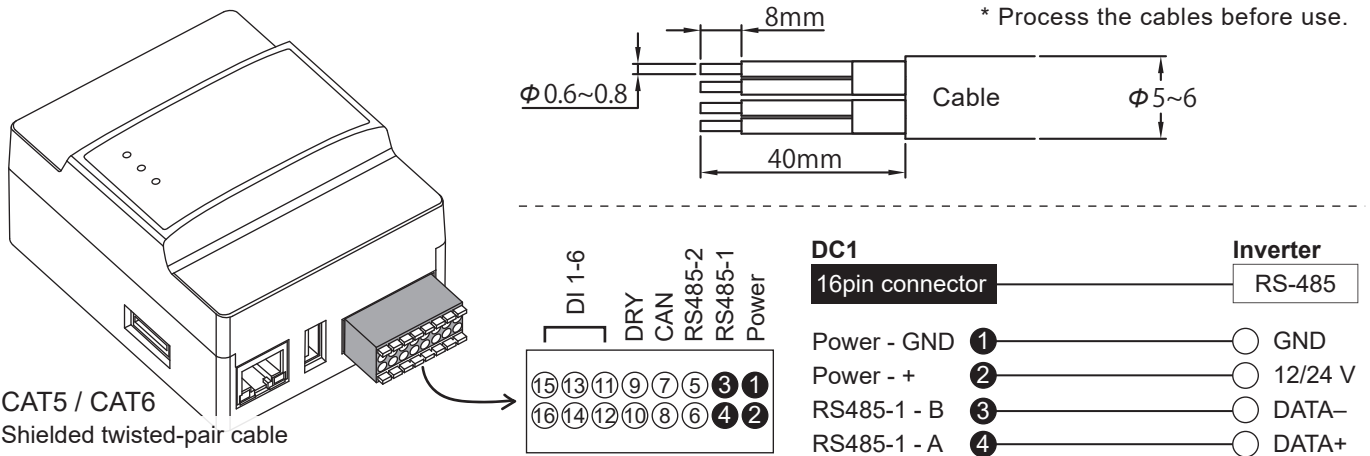

(2) Hold down both side ① of the 16-pin connector, insert cables and then connect to Data Collector.

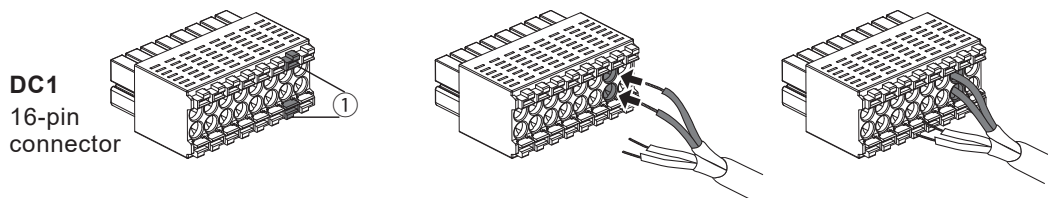

(3) Remove the RS-485 communications connectors from the inverter, and thread the cables through the waterproof gasket.

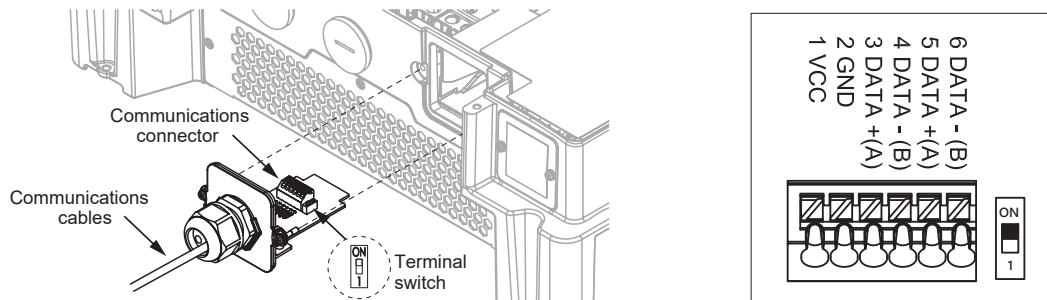

(4) Hold down side ② of the communication connector in the inverter, insert the cables connected to the DC1 16-pin connector.

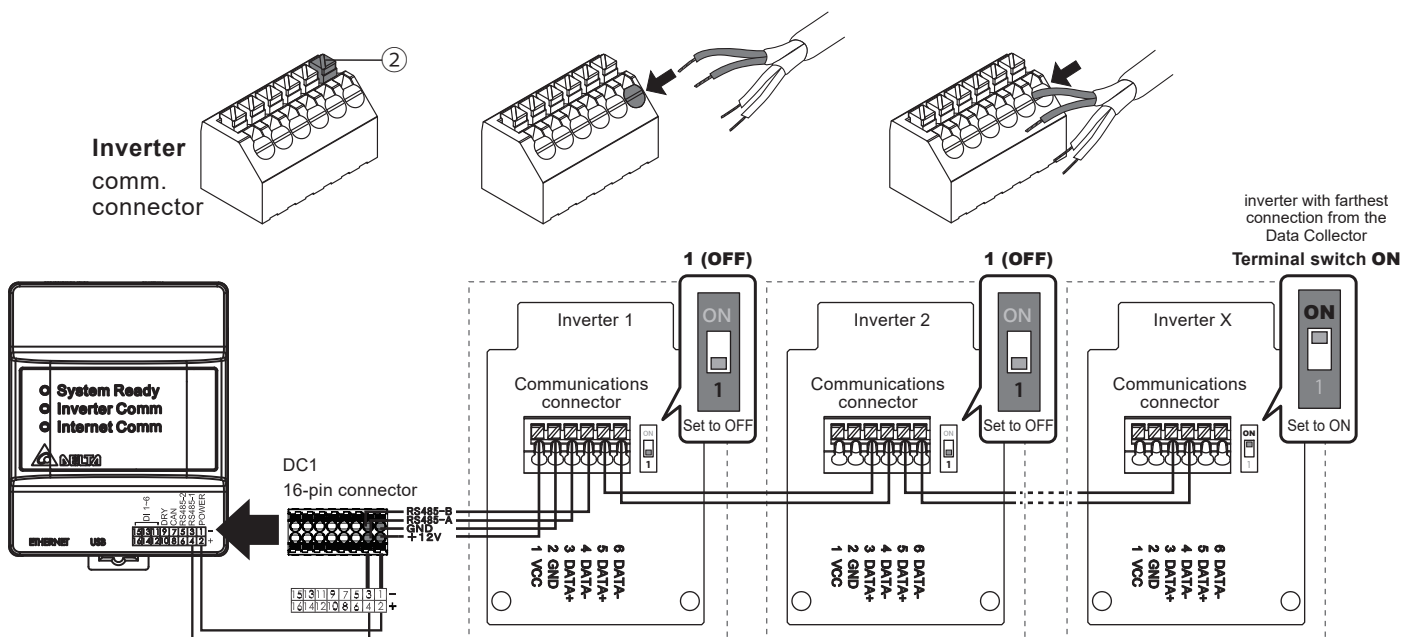

2.4.Download the APP



DeltaSolar

1. This APP should collocate with Delta Inverter.
2. If inverter is not connected to cloud, you still can monitor inverter by APP.



QR Code



iOS



Android

Where can search for DeltaSolar APP?

- QR Code: Please scan the QR code to MyDeltaSolar cloud.
- IOS system: Please search "DeltaSolar" in App store.
- Android system: Please search "DeltaSolar" in Google Play.



About OS version

iOS: 8.0 and above
Android OS: Android 8.0 and above

ATTENTION



- Please ensure the smart phone is connected to the Internet and the communication is good.
- Before setting up, please registered and sign in once in an internet-connected environment.

3.DC1 system application



When 3rd party monitoring and delta cloud monitoring are using at same time, suggest to add below IP into network white list to make sure remote function and cloud monitoring work normal.
 Back end remote function IP : 52.187.179.41 / Cloud monitoring IP : 52.237.74.126
 Suggest 3rd party monitoring system can enable VPN or Port forwarding function of the local router, so Delta service will able to remote debug when needed.

3.1.Normal mode

Inverter connect with DC1 via Wired (RS-485) or Wi-Fi, DC1 transfer inverter data to Delta Cloud.

RS-485

The RS-485 Inverter is set by operating the DC1 through the APP. Upload power generation data to Cloud Server for monitoring.

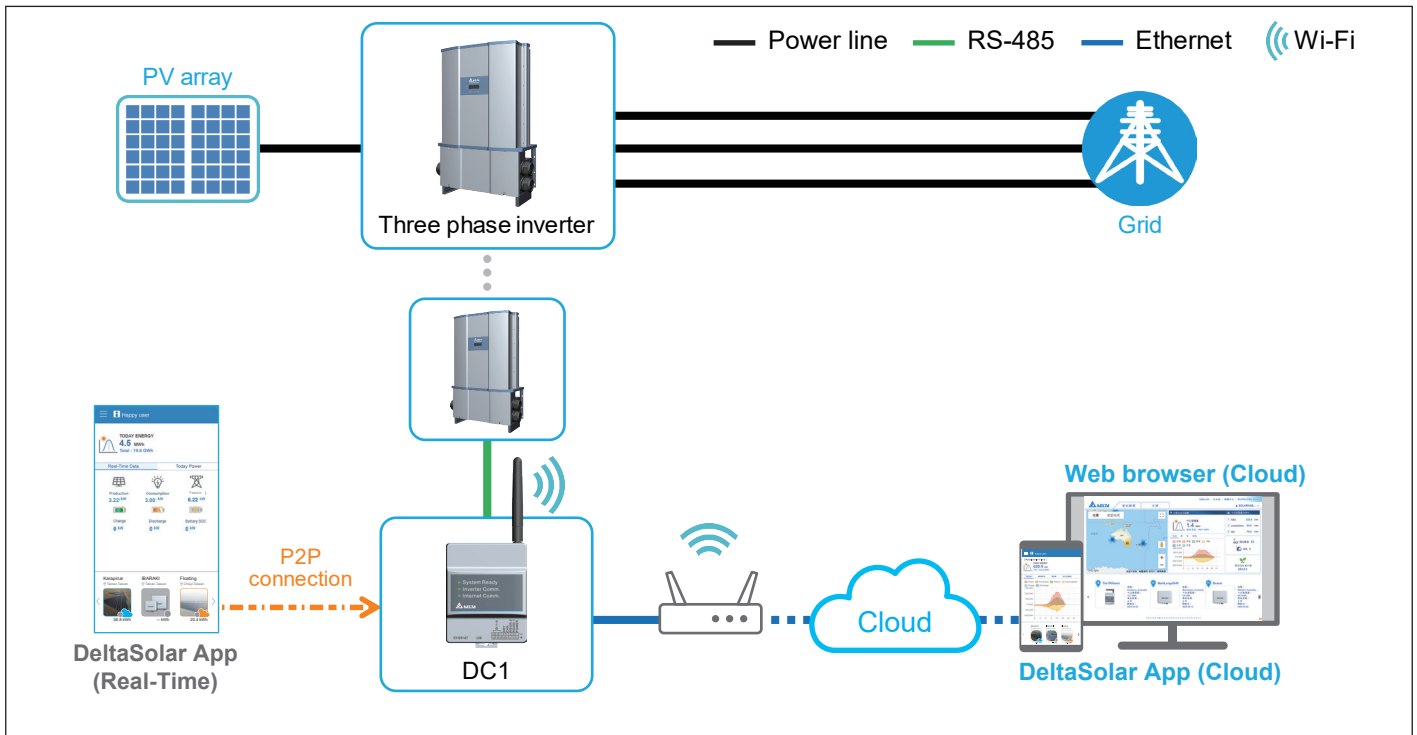

Wi-Fi

The WI-FI Inverter is set by operating the DC1 through the APP. Upload power generation data to Cloud Server for monitoring.

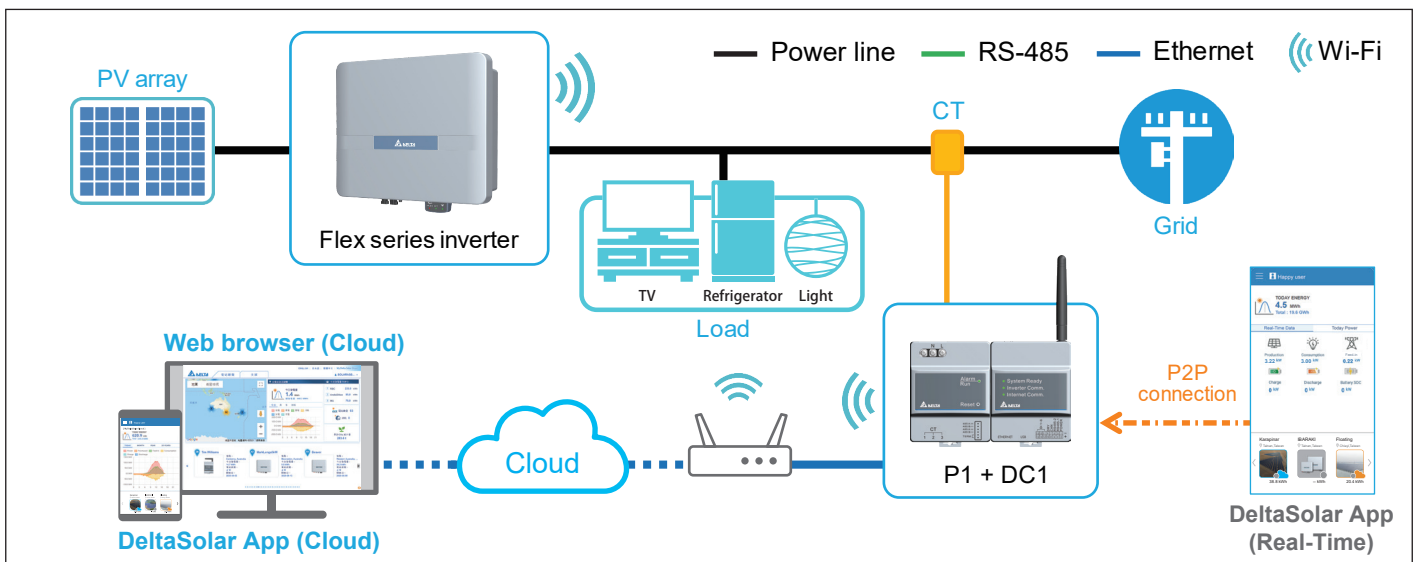

Connection type	Wired (RS-485) max. 32 inverters	Wi-Fi max. 9 inverters	Mixed max. 32 inverters
Solivia G3	○	—	○
Solivia G4	○	—	○
RPI HxA	○	—	○
HXA_2xx	—	○	○
M6/8/10A	○	○	○
M15/20A	○	—	○
M30A	○	—	○
M50A_12s	○	—	○
M88H	○	—	○
M15/20/30A_2xx	○	○	○
M50/70A_2xx	○	—	○
M100_210	○	—	○
M100A_280	○	—	○
M125HV	○	—	○

• Connection type

DC1 - Router: Ethernet or Wi-Fi / **DC1 - Smartphone:** Wi-Fi

Dynamic Power Control

(Export Limit Control & Generation Limit Control when P1/P3 is used.)

Function	VDE4105	AS4777
Description	Dynamically issue instructions to increase or decrease the output to the inverter based on the power import and export status to achieve a control output value as close to the limit value as possible. If the response times out, inverters will trip.	There are three modes: Export limit soft, Export limit hard, and Generation limit. One of the above settings represents different control load speeds and behaviors. Export limit soft: Try not to exceed the power export limit. If output exceeds the limit, a stricter load reduction will be performed, and inverters will not be forced to trip. Export limit hard: Try not to exceed the power export limit. If output exceeds the limit, inverters will trip. Generation limit: Try not to exceed the power generation limit. If generation exceeds the limit, load reduction is allowed within 15 seconds. If it's timeout times out and will be forced to trip. If output exceeds the limit, a stricter load reduction will be performed, and inverters will not be forced to trip.
Parameter Setting	Mode: To enable or disable the function. Limit Rates & Plant power capacity: Setting of the export power. (Allowable export power = Plant capacity x Limit Rate)	Mode: Export limit soft, Export limit hard, Generation limit Export limit power: Allowable export power to grid. Generation limit power: Allowable generation power for production.
Operating mechanism of abnormality	Meter is disconnected: Inv will be set to standby mode due to inability to obtain information. CT failure: It will cause the detected current value to be abnormal. Communication between DC1 and Inverter is lost: Inverter will show out an Error and trip. (Trip = Inverter off, need to wait for 1 minute before the restarting progress) (Standby=Inverter on, and power limit is set to 0%.)	

3.2.Retrofit mode

This function is only for Solivia Gateway, the Wi-Fi inverter is set by DC1 through the APP.
Start Solivia Gateway to monitor on Solivia Cloud.

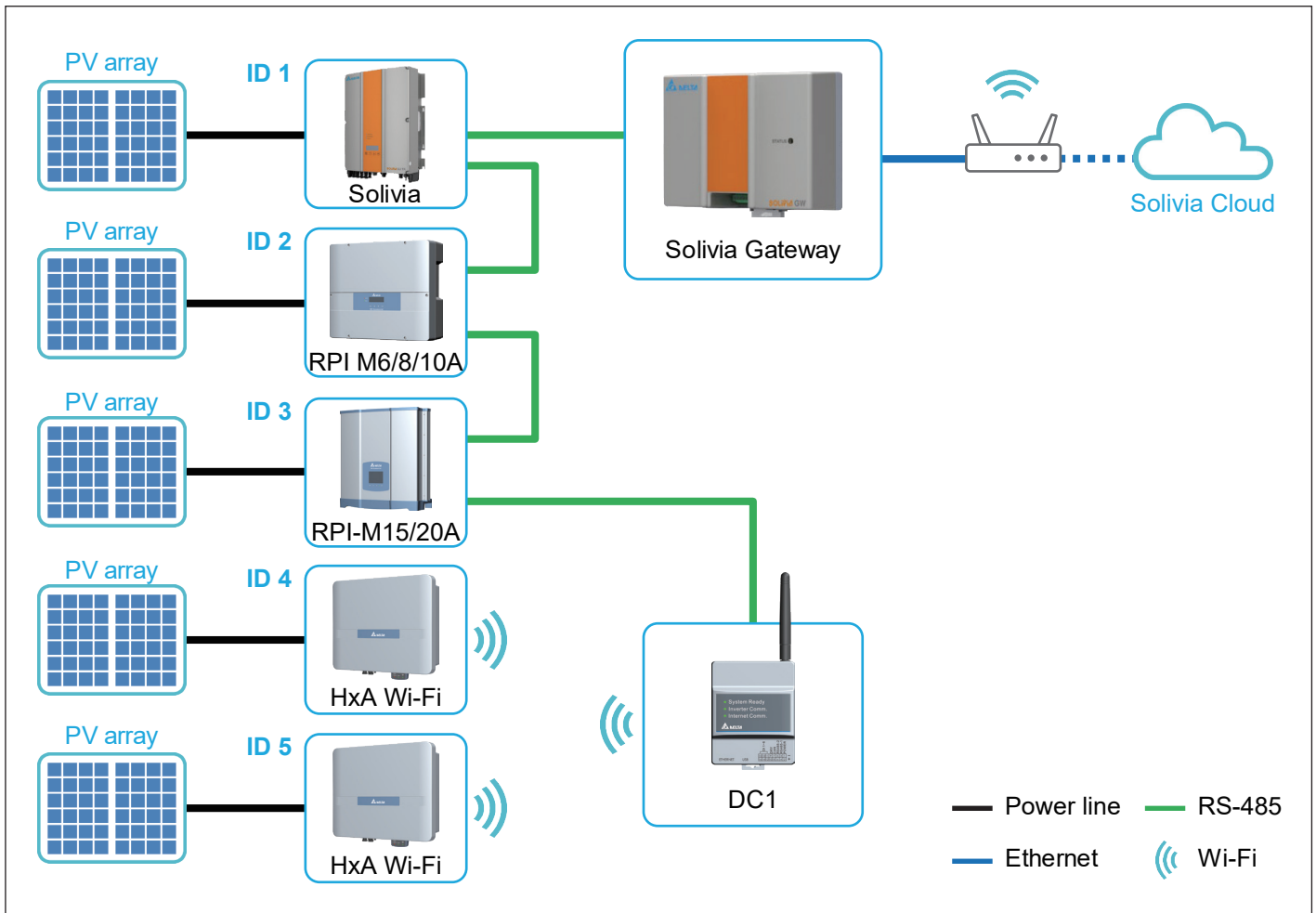

Connection type	Wired (RS-485)	Wi-Fi	Mixed
Solivia G3	not available	—	not available
Solivia G4		—	
RPI HxA		—	
HXA_2xx		○	

Note

One of the connected inverters must have RS485 ID (Inverter ID) = 1

3.3. 3rd party monitoring - Modbus tcp/ip

RS-485 or Wi-Fi inverter is set by DC1 through the APP.

After the setting is completed, the third-party monitoring reads the communication address of DC1 through Modbus to get the power generation data.

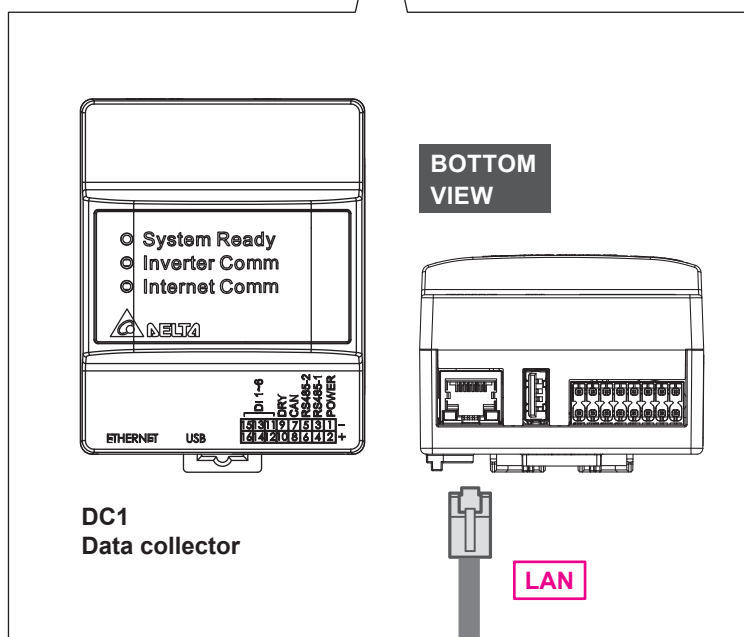
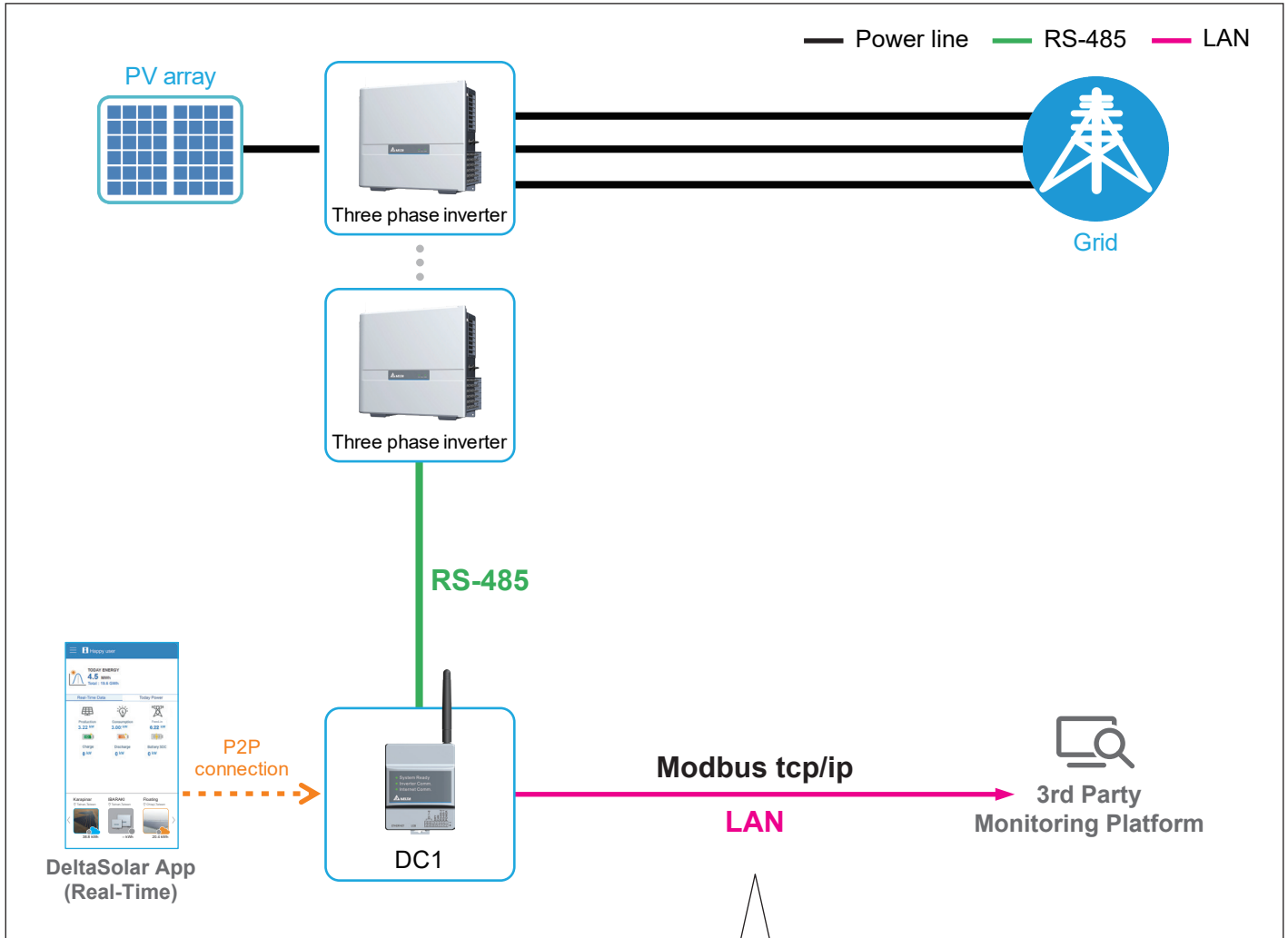

3.4 3rd party monitoring - Modbus RTU (Forward mode)

3rd party monitoring device with Delta Modbus RTU protocol address built in can be used.
 DC1 is master of inverters, also the slave of 3rd party monitoring device.

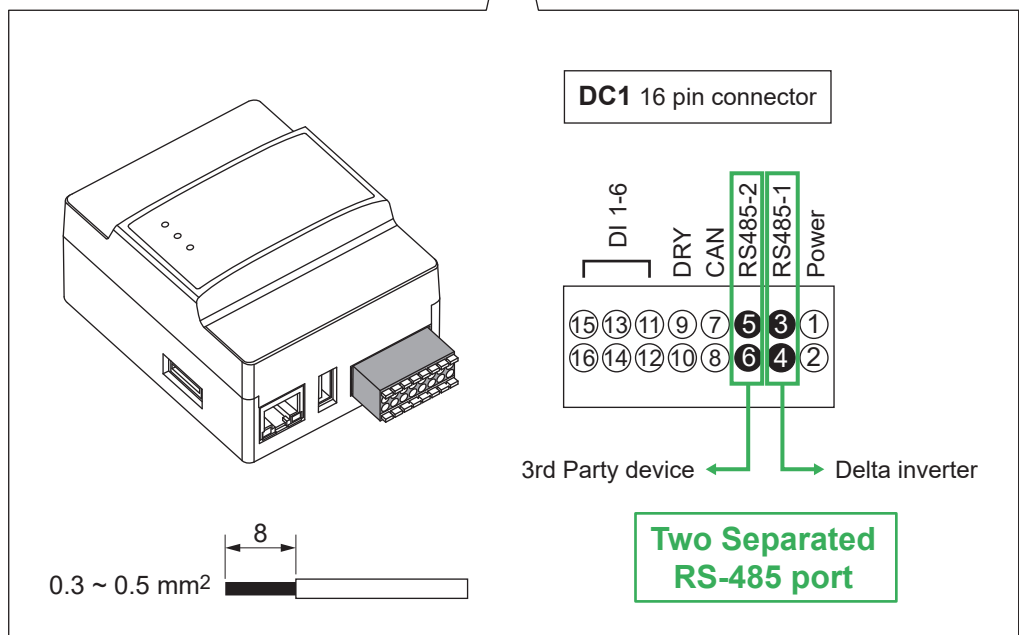
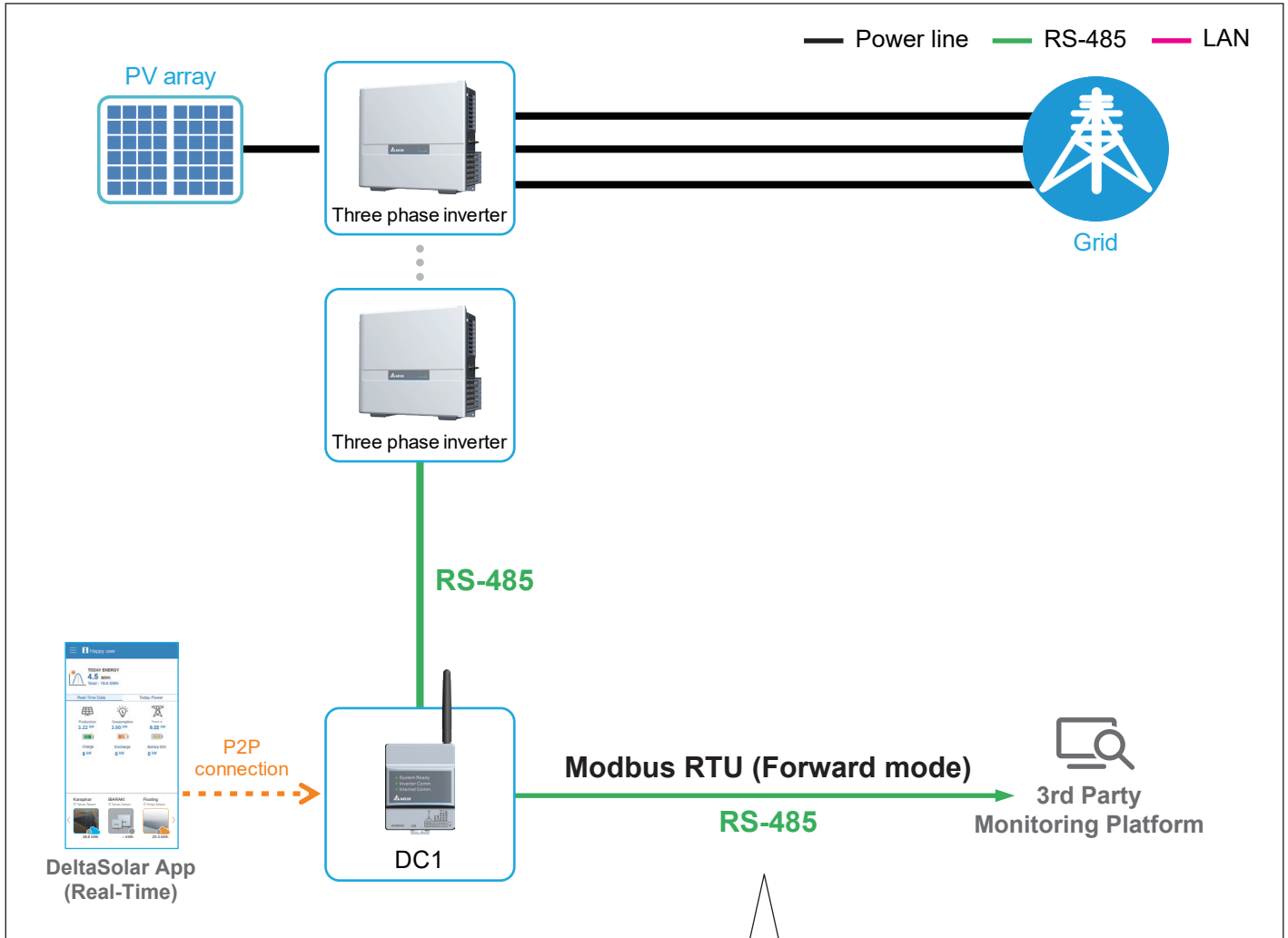

ATTENTION



- When forward mode is enable, DC1 will not able to deliver monitoring data to cloud and APP.

For details, please go to the following link for the APP operation manual.

DeltaSolar APP Operation Manual:



<https://mydeltasolar.deltaww.com/index.php?p=manual>

4. Specifications

ELECTRONIC SPEC		PPM DC1_100
Operating voltage range	9Vdc ~ 25Vdc (power port, can be supplied from inverter)	
Max. Power Consumption	5 Watt	
COMMUNICATION		
Wired	RS-485/ Ethernet	
Wireless	Internal Wi-Fi Module 802.11a/b/g/n	
REGULATION		
Safety Standard	EN 61010-1, CE compliance	
Emission (EMI)	EN 300 328, LP0002, Part 15C, Telec T66, KC	
Immunity(EMS)	EN 301 489-1/-17, EN 55024, EN 55032, FCC Part 15B	
CONNECTION		
I/O Port	2 pin terminal block for Power Port 4 pin terminal block for RS-485 2 pin terminal block for Can Bus 2 pin terminal block for Dry Contact 6 pin terminal block for digital inputs RJ-45 connector for Ethernet USB Port for data storage	
GENERAL INFORMATION		
LED Display	System Ready, Inverter Comm., Internet Comm.	
Operation temperature	-25°C ~ 60°C	
Relative humidity	30% ~ 85%	
Dimension (WxHxD)	72 x 90 x 55 mm	
Weight	160g (with Wi-Fi antenna)	

DC1 Functions

- **Data monitoring:**
Able to monitoring data from inverter to cloud or 3rd party monitoring system.
- **Connection & Grid setting :**
Support initial or function setting for inverter.
- **Firmware Update:**
Available to update FW by APP or USB for inverter and DC1 itself.
- **BACKUP/RESTORE:**
Backup the connection setting of DC1, after replacement of DC1 just need to restore the data back no need to set from the beginning.
- **REPLACE INVERTER:**
This function support change connection setting of DC1, after replace the inverter with new one.
- **DRM0 (Digital input) :**
This function can set inverters to specific power limit by shorten the corresponding connections.
- **PARTIAL/ZERO EXPORT:**
This function support dynamic output control application.
- **DRY CONTACT :**
When enable this function, the dry contact relay inside DC1 will close to trigger external device.
- **PHASE INTERLOCK:**
Only for AU market, turn on when needed. If one of the inverter lose communication with DC1, other inverter will also remote off.



For details, please go to the following link for the APP operation manual.

DeltaSolar APP Operation Manual: <https://mydeltasolar.deltaww.com/index.php?p=manual>



5. When Something Seems Wrong (Troubleshooting)

5.1. Error Displays



When a problem occurs, confirm the Error message from the [ERROR EVENTS LOG] page of [History].



Details can be verified in the “ERROR EVENTS LOG” pages.
Refer to the Manual of the Inverter for details on the error codes.

5.2.Troubleshooting

Responsive actions that should be taken in cases where the following symptoms occur are described.

Symptom	Verification details	Responsive action
 <p>System ready light is red</p>	DC1 is booting	Please wait two minutes for the boot to complete
 <p>Inverter comm light is continuously flashing green light</p>	DC1 is Searching or Setting inverters.	Please wait for 2-10 minutes for Inverter to search or set up.
 <p>Internet light constant</p>	DC1 does not connect to internet	Please go to the NETWORK page to set network. For detailed setting process, please refer to APP manual.

Appendix - PPM P1_120

1. Functions of Parts

A	Ø	Reserved, no electrical connection allowed
	N/L	Mains voltage connector block
B		CT wire connector
C		Connect with Data Collector
D		Meter status LED
E		Reset Button
F		RS-485 port & terminal resistor port

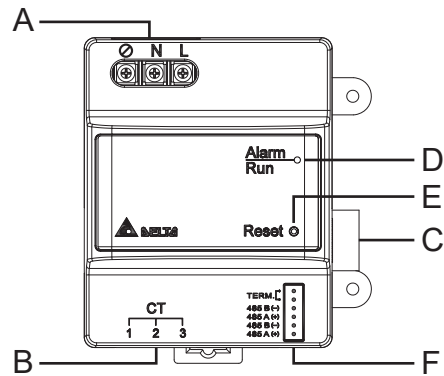

2. LED Description

LED	Status	Explanation
Red	On	Hardware failure
Red	Blink	No communication from other device
Green	On	Normal
Green	Blink	Wait for connection

3. Specifications

ELECTRONIC SPEC	PPM P1_120
Communication	RS-485
Input voltage range	85 Vac - 264 Vac
Nominal voltage	230 Vac
Frequency	50Hz / 60Hz ± 5%
Max. Self - consumption	2 W
Max. consumption - With Data Collector	7 W
Current transducer	120 A
Sensing aperture dimension	Ø15.0 mm
Torque for screw terminal	0.98 Nm
Certificate	EN61010-1, CE Compliance, EN61326
Weight (without current transformer)	170g
Dimensions (W / H / D)	72 mm x 90 mm x 55 mm
Ambient temperature in operation	- 20°C to 60°C
Ambient temperature during transport / storage	- 30°C to 70°C
Operating humidity	30% to 85% (non-condensing)
Storage humidity	30% to 85% (non-condensing)

Appendix - PPM P3_120

1. Functions of Parts

A	Mains voltage connector block
B	CT wire connector
C	Connect with Data Collector
D	Meter status LED
E	Reset Button
F	RS-485 port & terminal resistor port

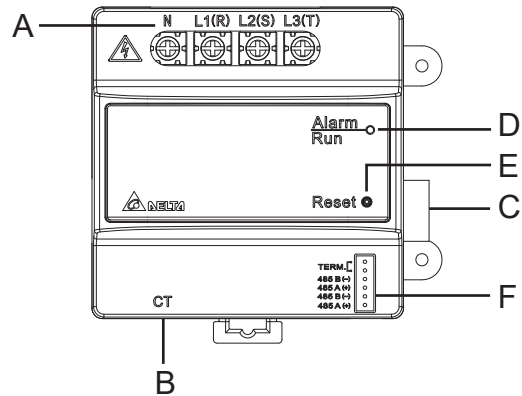

2. LED Description

LED	Status	Explanation
Red	On	Hardware failure
Red	Blink	No communication from other device
Green	On	Normal
Green	Blink	Wait for connection

3. Specifications

ELECTRONIC SPEC	PPM P3_120
Communication	RS-485
Input voltage range	95 Vac - 277 Vac (L-N)
Nominal voltage	3P4W 277 Vac, 3P3W 480 Vac
Frequency	50Hz / 60Hz \pm 5%
Max. Self - consumption	3 W
Max. consumption - With Data Collector	8 W
Current transducer	300 A
Sensing aperture dimension	23mm x 24.5mm
Torque for screw terminal	1 Nm
Certificate	EN61010-1, CE Compliance, EN61326
Weight (without current transformer)	215 g
Dimensions (W / H / D)	90 mm x 90 mm x 55 mm
Ambient temperature in operation	- 20°C to 60°C
Ambient temperature during transport / storage	- 30°C to 70°C
Operating humidity	30% to 85% (non-condensing)
Storage humidity	30% to 85% (non-condensing)
Measurement Accuracy	Class I (Ambient temperature 25°C)

