



Digitized Automation for a Changing World

Delta AC Servo Drive & Motor ASDA-B3 Series

Delta Standard Servo System ASDA-B3 High Efficiency, User-Friendly, and Stable

The high tolerance and stable operation of the Delta standard servo system ASDA-B3 series creates a highly efficient and user-friendly operation environment with precise motion control functions that optimize production efficiency and output value.

With the best motion control solutions, Delta boosts industry momentum and works with customers to create an innovative future.





Table of Contents

Optimized Performance	1
Various Motion Functions	3
EtherCAT Communication Functions	5
Vibration Suppression Functions	7
Self-Diagnosis and Adaptation	8
Energy-Saving and Compact Size	9
Multiple Selections	10
User-Friendly Software Interface	11
Applications	13
Servo Drive & Accessories	15
Accessories	16
Servo System Combination Table	17
Servo Drive Model Name	21
Servo Drive Specifications	22
Servo Motor Model Name	27
ECM-B3 Series Servo Motor Specifications	28
ECM-A3 Series Servo Motor Specifications	46
Control Mode Wiring	50
Ordering Information	58
Servo Drive Standards	68

Optimized Performance

High Response Bandwidth

- Higher responsiveness: From 0.5kHz of the ASDA-B2 series to 3.1kHz of the ASDA-B3 series
- Increased productivity: Settling time reduced by 40%

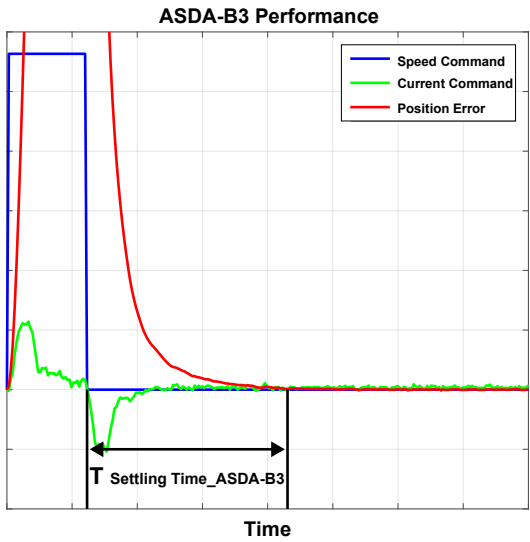
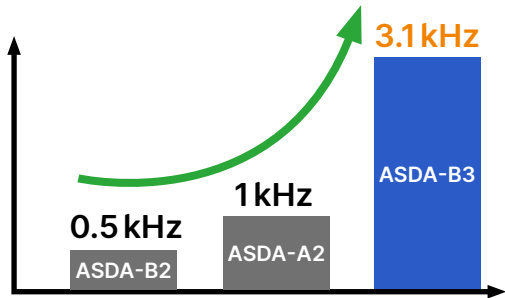

Higher Load Tolerance

- Enhances positioning precision and optimizes the system
- Higher response bandwidth with the same load conditions

	ASDA-B2	ASD-B3	ASDA-B2	ASD-B3	ASDA-B2	ASD-B3
Actual Load Inertia Ratio	30 times		50 times		70 times	
Speed Loop Bandwidth in Position Mode	Approx. 150Hz	Approx. 250Hz	Approx. 30Hz	Approx. 150Hz	Max. performance	Approx. 20Hz

24-bit Absolute Encoder

- Enhances positioning precision with a resolution of 16,777,216 pulses per revolution
- Stable operation at low speeds improves machine performance
- Absolute encoder retains the motor's position when the power is off

16,777,216 pulses for one single turn

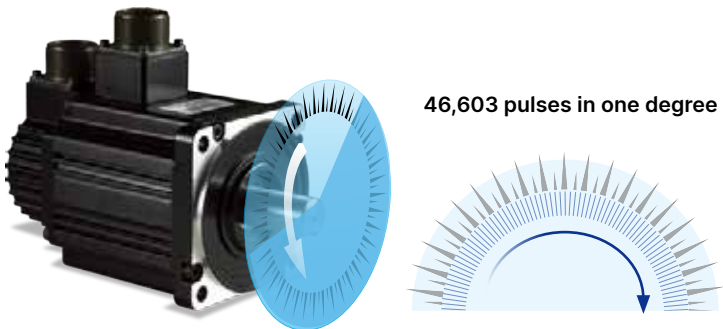

Low Cogging Torque

The cogging torque is 50% of previous models which increases the smoothness of constant speed operation and low speed machining

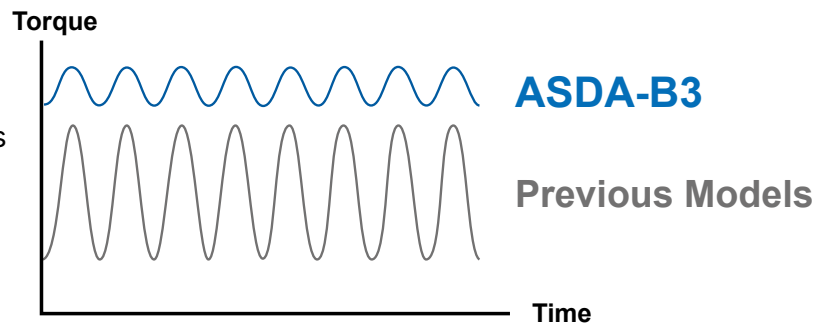

Increased Speed and Torque

- Motor speed increased to 6,000 rpm
- Torque overload ratio increased to 3.5 times and the time required for acceleration and deceleration is shortened
- Significantly increases productivity and efficiency

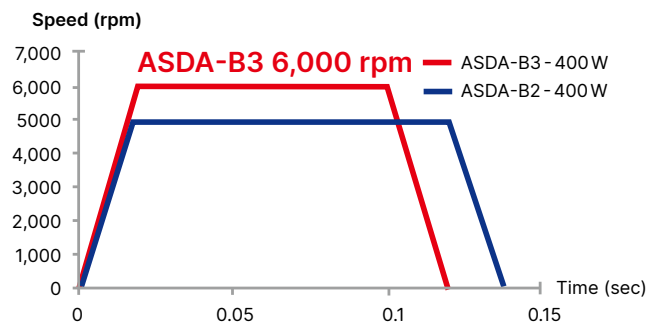
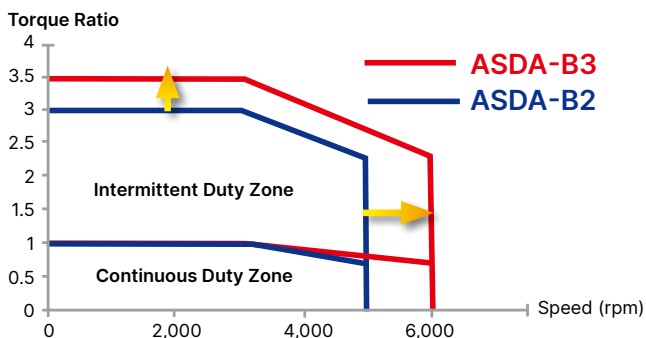

Safe Torque Off (STO) Function

- Built-in STO function ensures personnel safety
- Complies with IEC/EN 61800-5-2
- SIL2 Level

Note: ASDA-B3A 400V certification in process

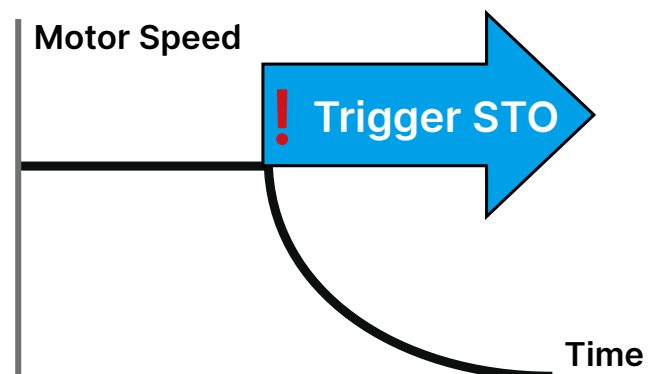

Various Motion Functions

PR Mode

- Supports up to 99 PR paths for flexible motion command planning
- Intuitive operation interface with graphics
- Homing modes, position commands, and speed commands
- Overlap command, interrupt command, jump command, and parameter settings

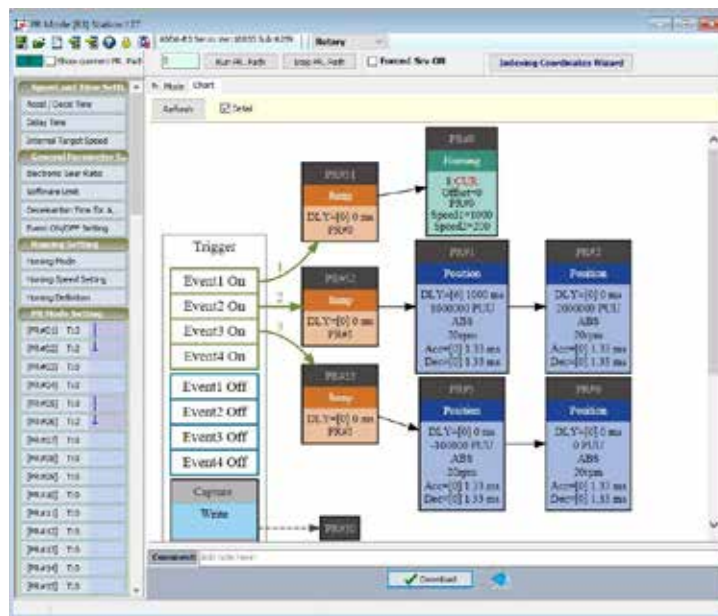

High-Speed Capture Function

- Supports the Capture function for instantly capturing position coordinates with one set of DI
- Supports the Touch Probe function with two sets of DIs in the EtherCAT communication mode

Note:

Capture function: DI4 (B3-F, B3-M), DI7 (B3-L)

Touch Probe function: DI1, DI2 (B3-E)

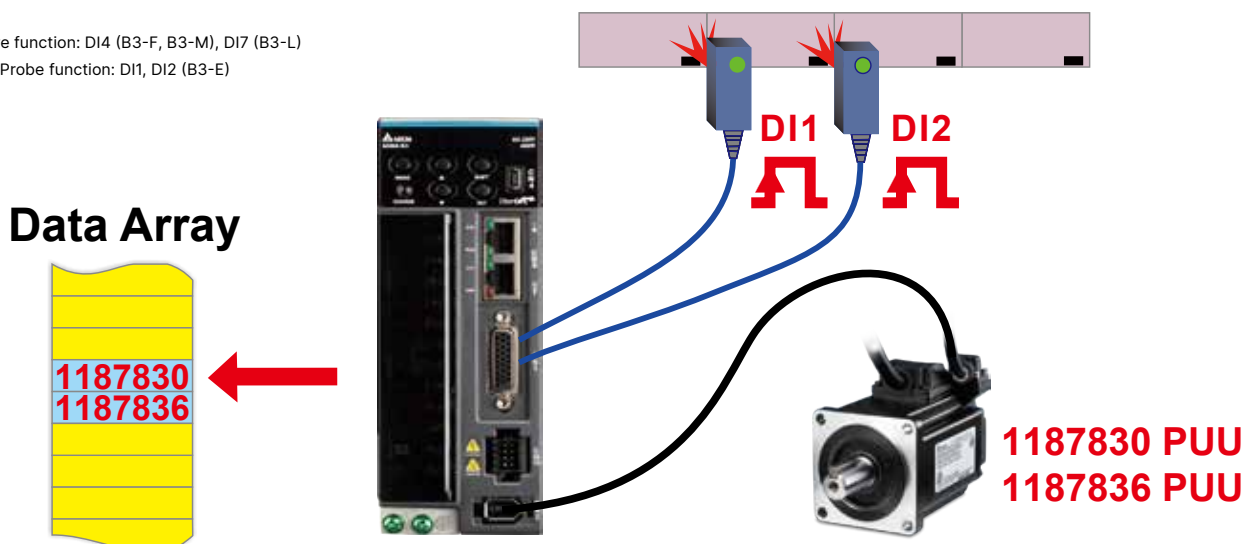

Analog Feedback PID Control

- Supports analog signal input
- Real-time and precise PID control enabled by the analog signals from the external sensor improves production yield and processing performance

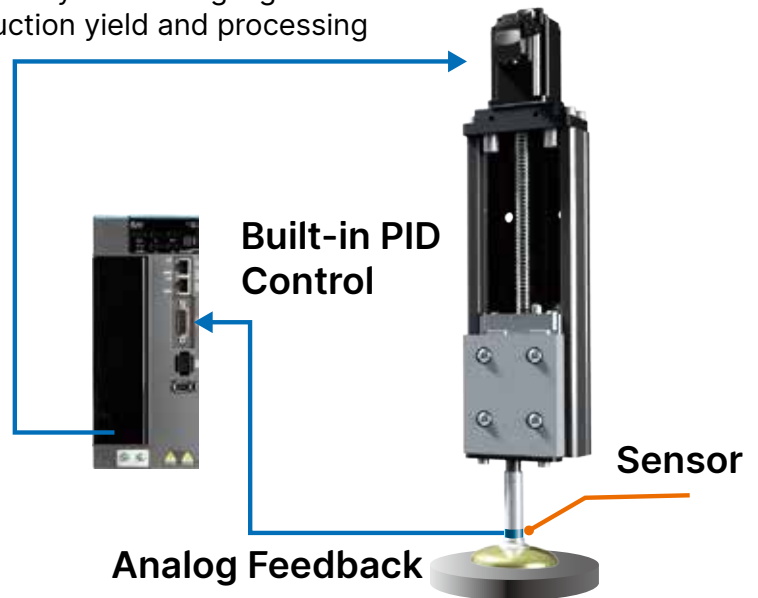
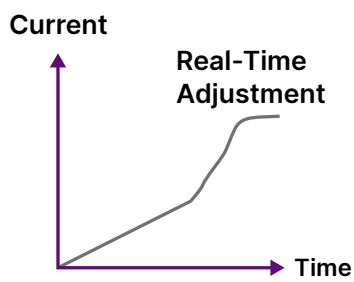

EtherCAT Communication Functions

Complies with the IEC 61158 and IEC 61800-7 fieldbus standards

Shorter Synchronization Cycle

- The synchronization cycle of the ASDA-B3 series is 125 μ s, which is 8 times faster than that of the ASDA-A2 series

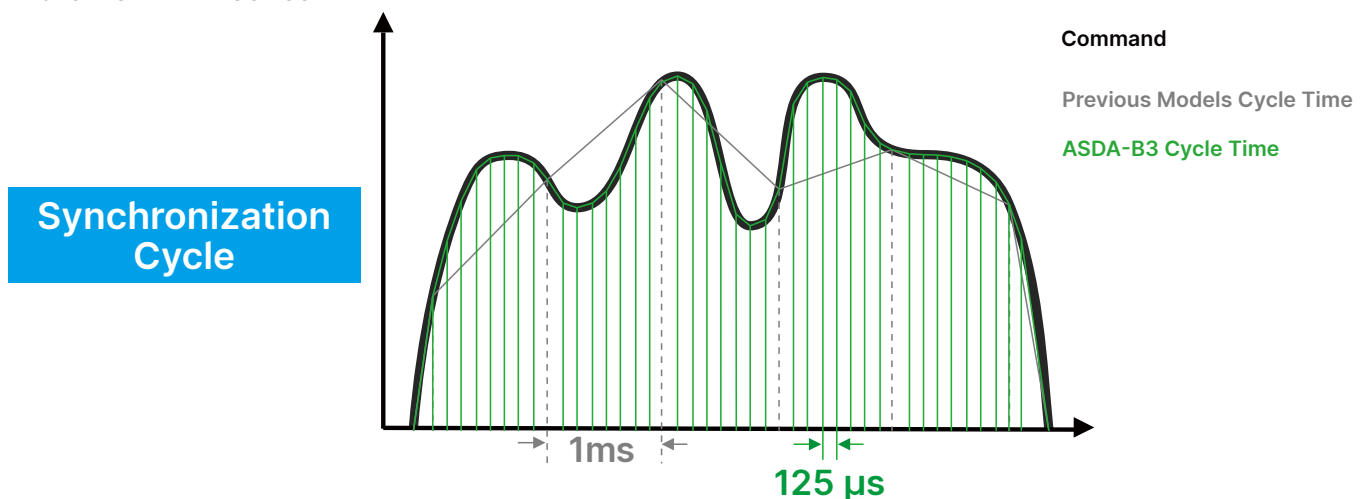

Simplified Wiring

In contrast to single-axis pulse wiring which is complicated and difficult to repair, the EtherCAT high-speed communication greatly reduces the wiring and inspection time. It is suitable for multi-axis control and can also connect remote I/O modules with a single wiring.

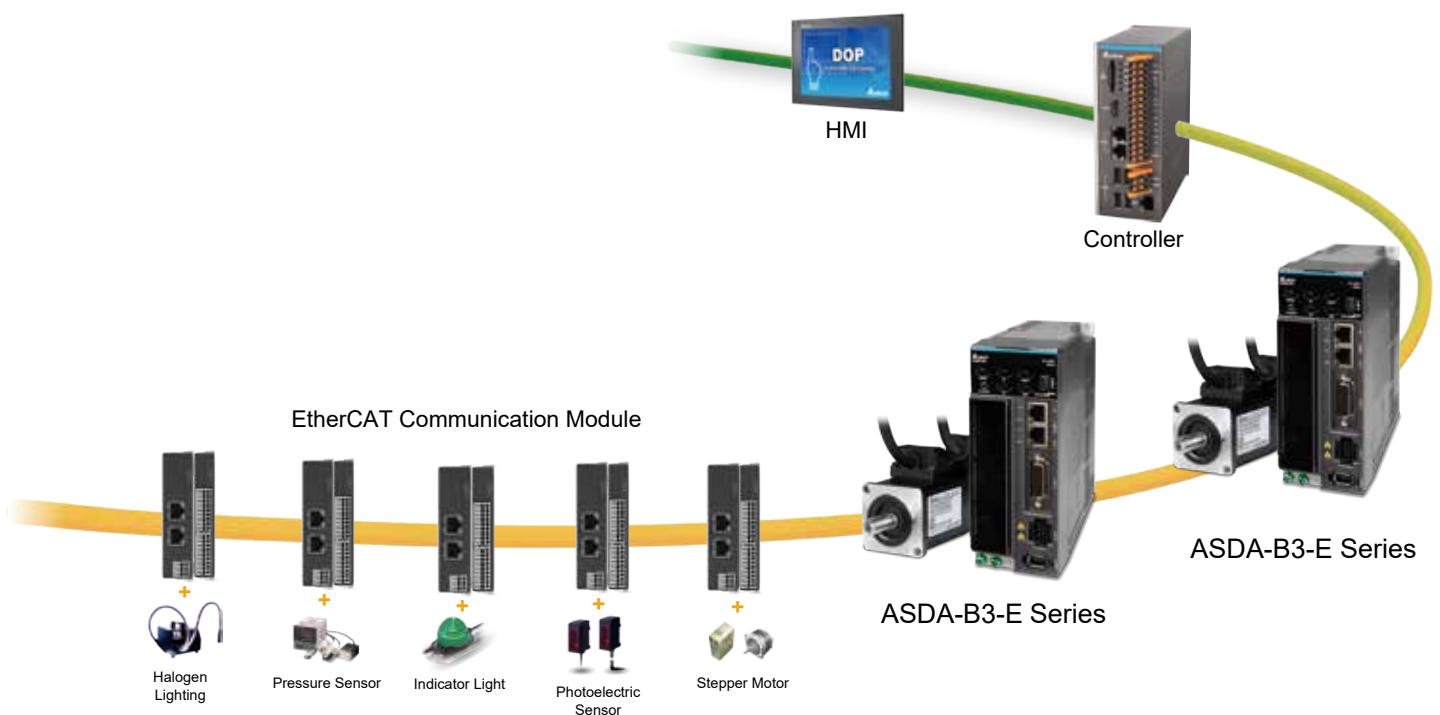

Longer Connection Distance

The maximum distance between two servo stations is 50 m and a maximum of 65,536 axes can be connected

Compatible with Previous Models

The ASDA-B3 series models are compatible with the ASDA-A2 and ASDA-A3 series

Note: The communication cycle of the ASDA-A2 series is 1ms, so when previous and new models are used together, the set value cannot be lower than this specification

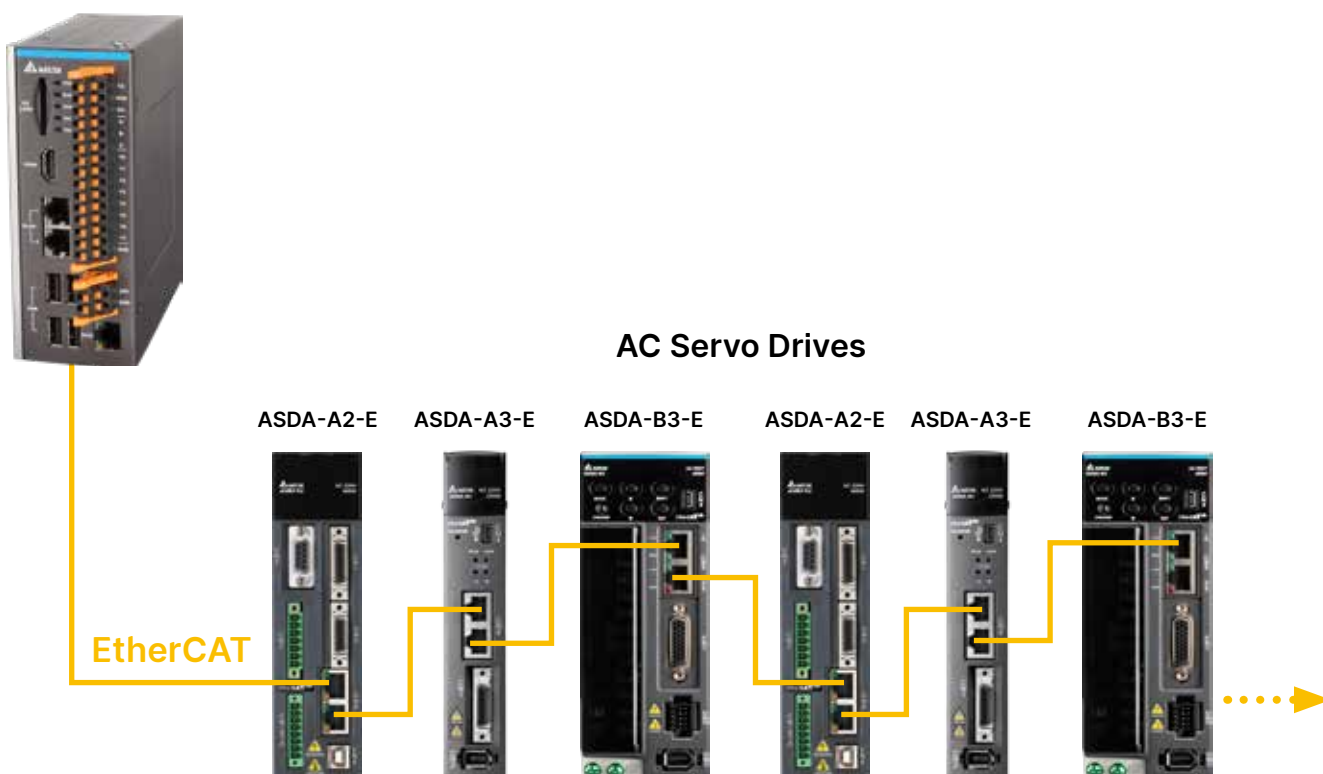

Vibration Suppression Functions

Vibration Elimination

- Low frequency vibration suppression applies Delta's unique algorithm to adjust low rigidity machine structures
- Two sets of built-in vibration elimination settings reduce jitter at the machine endpoint while maintaining a good command response

Without Vibration Elimination - Machine endpoint vibrates when settling

With Vibration Elimination - Machine endpoint is stable when settling

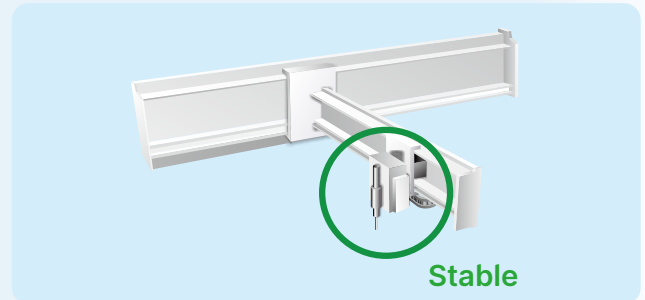
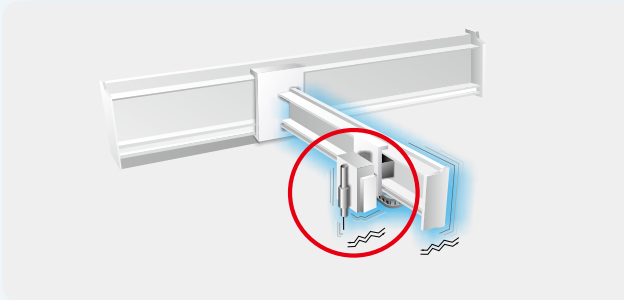

Advanced Notch Filter

- High frequency resonance suppression increased from 3 sets to 5 sets compared with previous models
- Filter bandwidth increased to 5,000 Hz
- Automatically searches for the resonance frequency point and completes the resonance suppression; this reduces the time by 70% compared with previous models and is less likely to damage the machine

Attenuation Rate

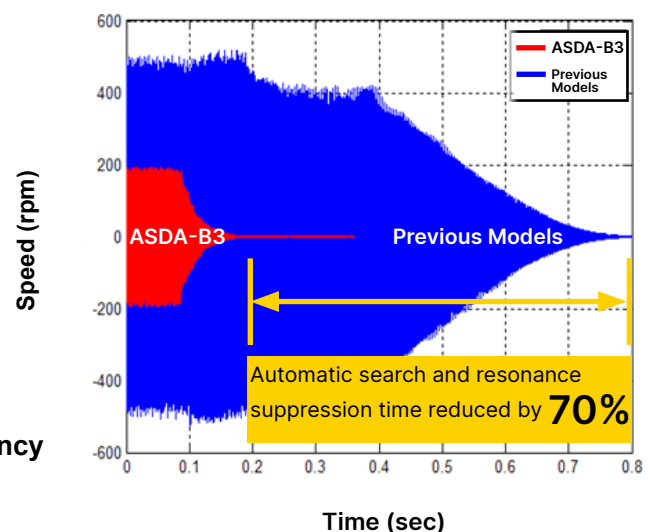
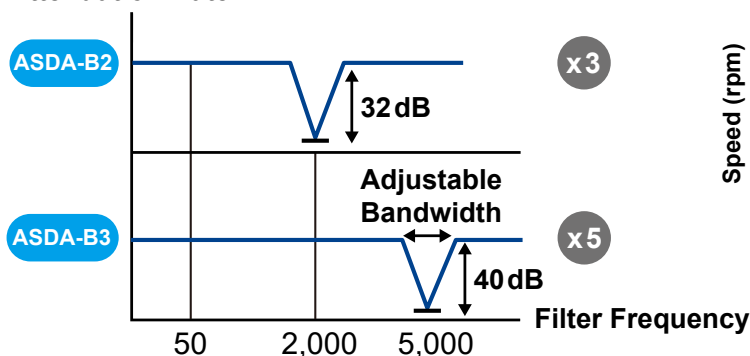

Self-Diagnosis and Adaptation

Excellent Self-Adjusting Capability

- Dedicated algorithm allows easy tuning with simple settings, which improves the efficiency of equipment assembly and testing
- Suitable for applications with flexible machine structures and large variations in inertia

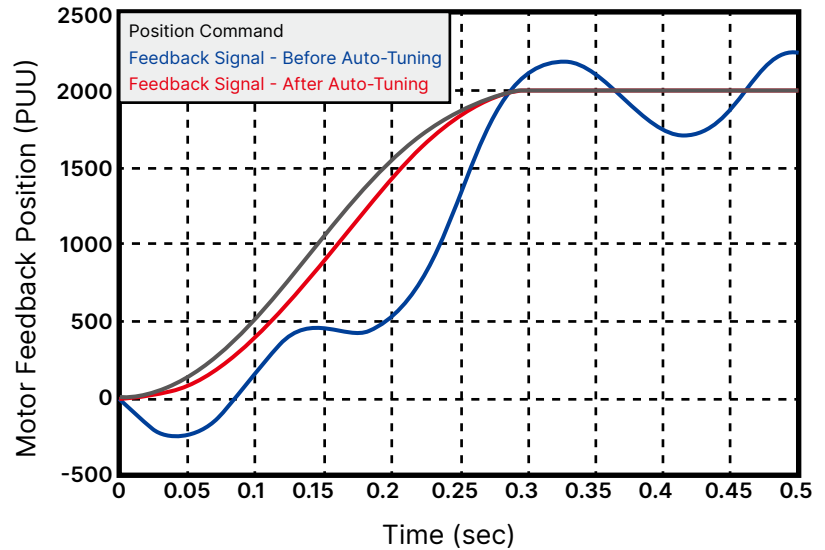

System Analysis Tool

Mechanical Stiffness Diagnosis

- Diagnoses the mechanism elasticity and damping coefficient, and converts the machine structure characteristics into data
- Ensures consistency of mass production machines through data collection

Frequency Domain Response Analysis

- Ensures system stability
- Compares the phases before and after gain adjustment to ensure the safety margin of the system

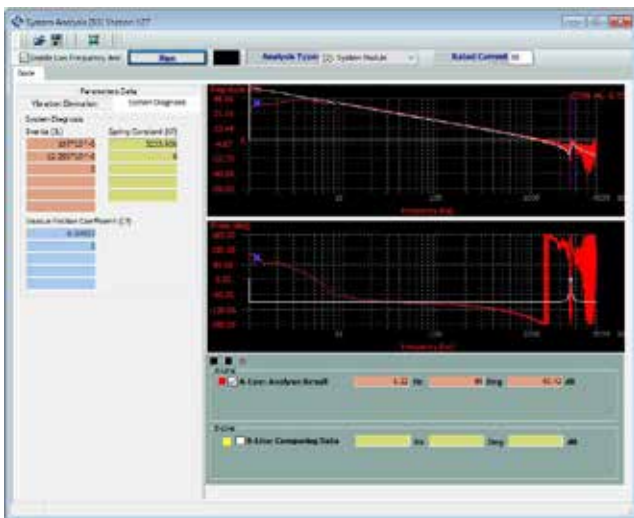

Energy-Saving and Compact Size

Compact Size

- The size of the servo drive is reduced up to 20%, so it requires less space in the distribution board which meets the need for more compact equipment
- The size of the servo motor is reduced up to 31% for less space and cost efficiency

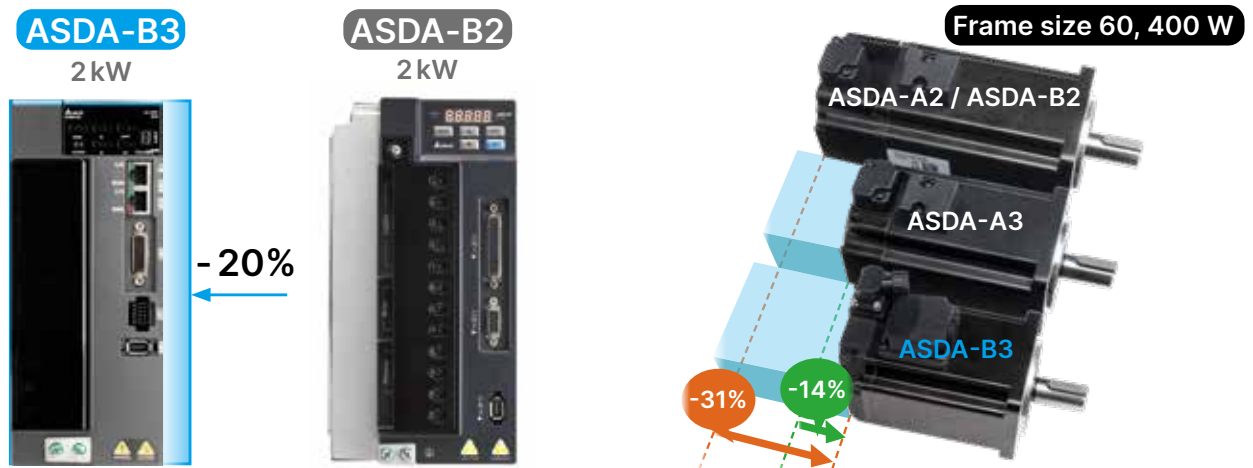

Common DC Bus

- The servo drives can share the DC Bus to reuse regenerative energy for reducing energy consumption
- When multiple servo drives share the common DC Bus, fewer regenerative resistors are required for cost efficiency

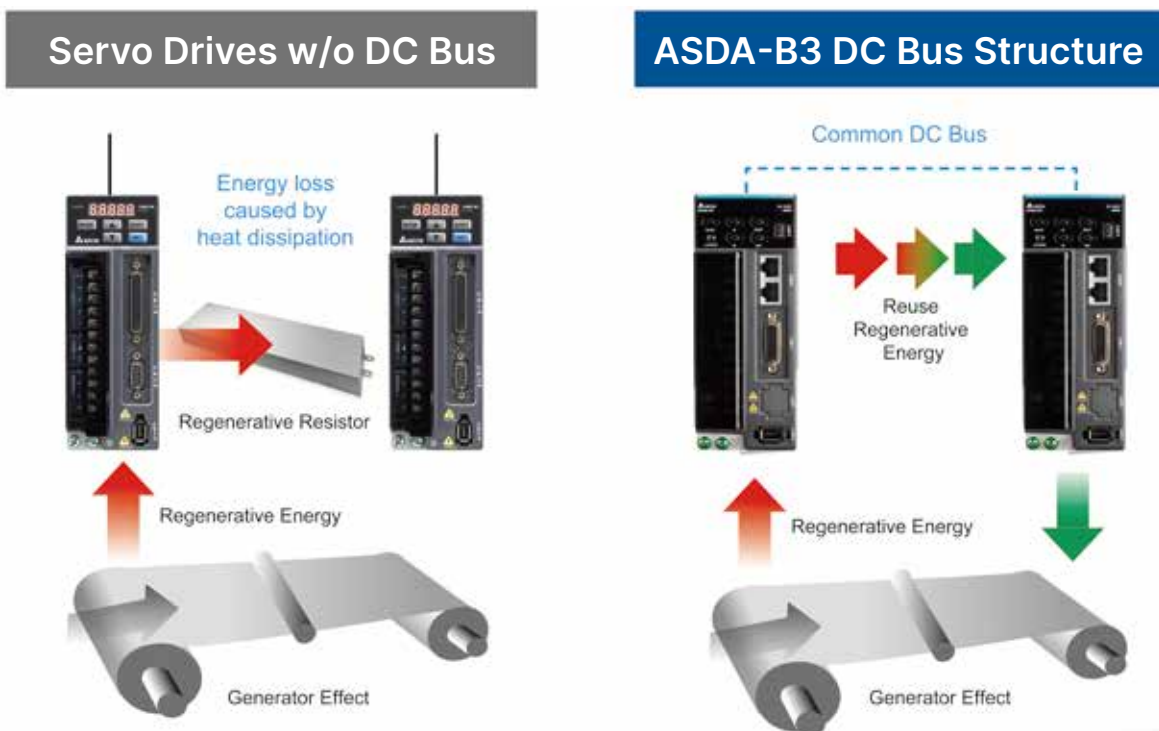

Multiple Selections

High Resolution Encoder

- High resolution for more precise positioning
- The incremental encoder can retain the single-turn absolute position without the need to execute homing after cycling the power
- After the absolute encoder is powered off, the number of turns and position are retained
- 24-bit optical encoder: The encoder is lighter and thinner with the reflective sensor technology; the exclusive optical sensor compensation function improves product reliability
- 17-bit magnetic encoder: The magnetic induction technology improves the capability to prevent vibration and increases the oil resistance level

Optical Encoder

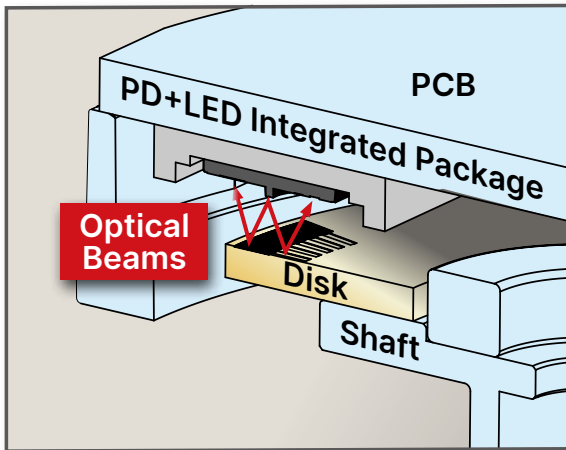

Magnetic Encoder

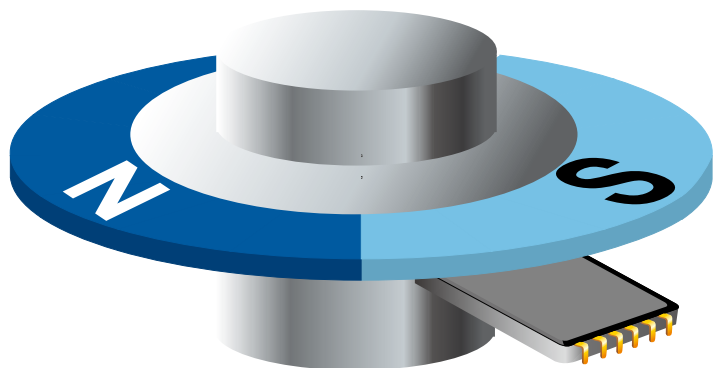

High Compatibility

- Compatible with the ASDA-A2 / ASDA-B2 / ASDA-A3 series motors for easier replacement
- Motors of high, medium, and low inertia are available for different applications

High inertia motor: Suitable for applications that require speed stability or resistance to external forces

Medium inertia motor: Suitable for applications with general mechanical equipment

Low inertia motor: Suitable for high-speed positioning and high response applications



ECM-B3 Motor



ECM-A3 Motor



ECMA/ECMC Motor

User-Friendly Software Interface

Function List Tree View

- Well-organized function list for quick access
- Expandable and collapsible nodes for easier and more efficient operation

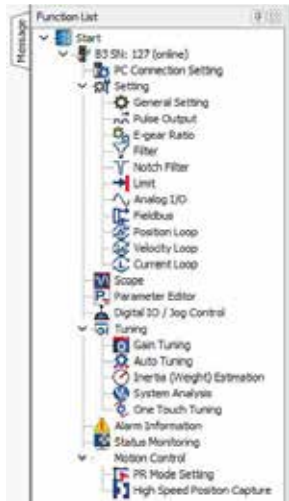

Graphical Parameter Setting

- Intuitive graphic illustrations for gain adjustment and parameter settings

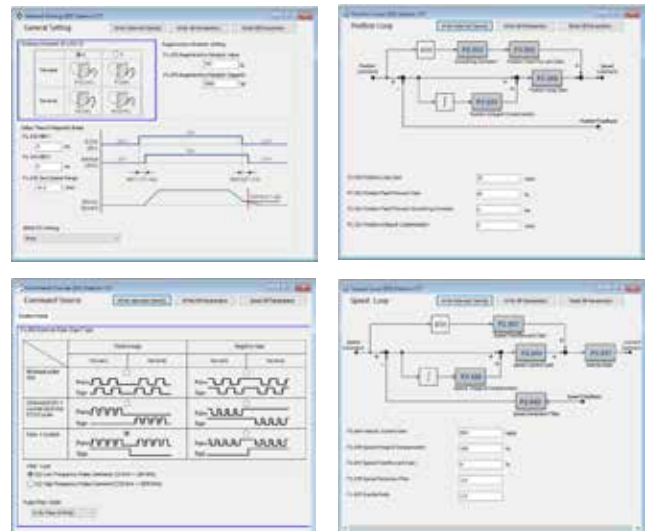

Auto-Tuning Function

- Step-by-step and conversational UI for servo gain adjustment



Advanced Gain Adjustment Function

- Provides advanced gain adjustment modes for fine tuning according to different applications and operating characteristics
- Step-by-step software interface to guide users



System Analysis Interface

- **Speed Open-Loop Mode**

Determines if the current system is the most optimized and thus improves the design

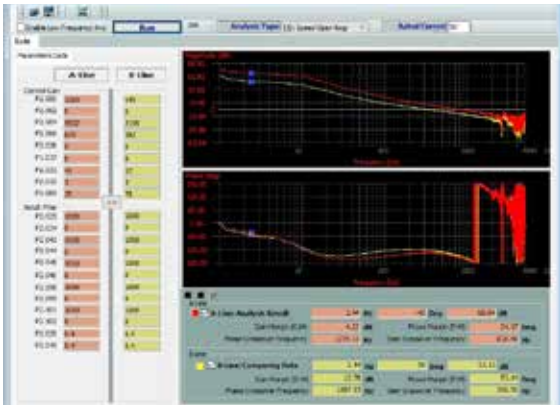

- **System Module Mode**

Measures the mechanical stiffness of the mechanism in this mode

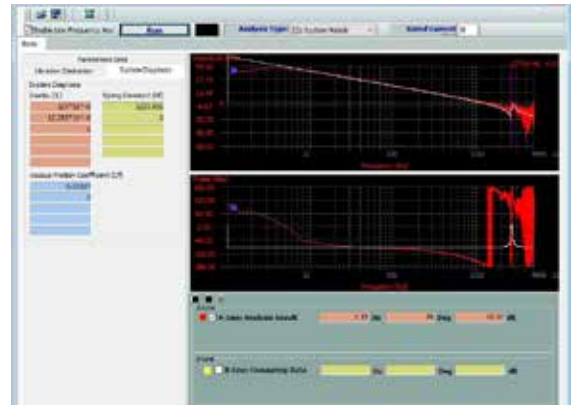

Oscilloscope Function

- Maximum of 8 channels with 16-bit data size and update frequency of 8 kHz
- 4 high-resolution channels with 32-bit data size and update frequency of 8 kHz
- 4 channels of high sampling rate with 16-bit data size and update frequency of 16 kHz

- Drag the cursor to specify the area for instant FFT (Fast Fourier Transform) and RMS calculation
- Set the triggering conditions for collecting data

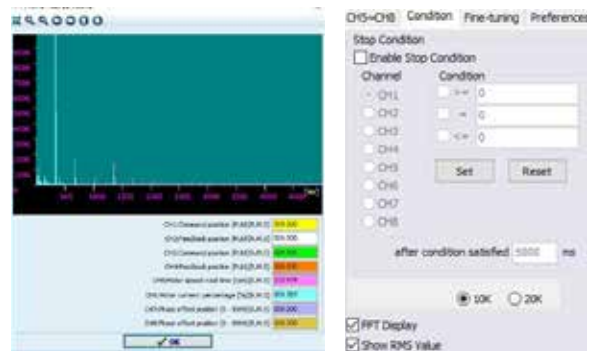
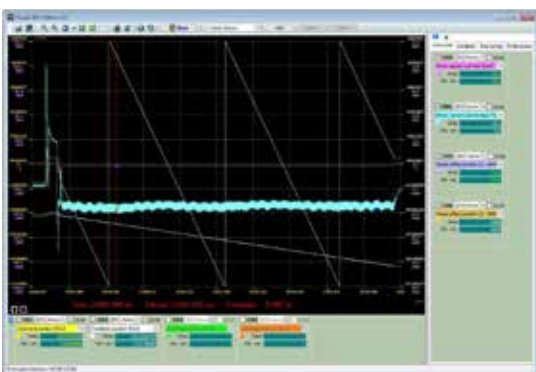

Graphical PR Path Programming Interface

- Graphical PR procedures with detailed settings for better command programming and editing

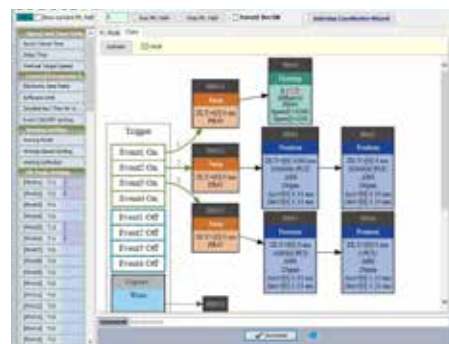

Applications

AOI (Automatic Optical Inspection) System

- Shorter setting time of ASDA-B3 shortens the detection time which also increases the production capacity

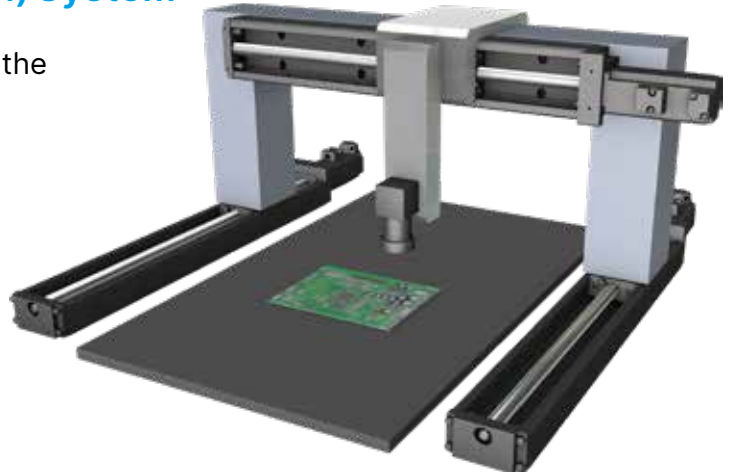

Tool Magazine and Turret

- Shorter response time of ASDA-B3 significantly reduces the tool changing time
- New communication trigger function for the tool magazine increases the number of tools without occupying DI points
- Common DC Bus function reduces the use of regenerative resistors and improves the power consumption efficiency



Wafer Pick and Place Machine

- Analog feedback of the PID control with external sensors provides precision control of downward pressure
- Two-stage downward motion planning with high speed and soft landing improves productivity and yield

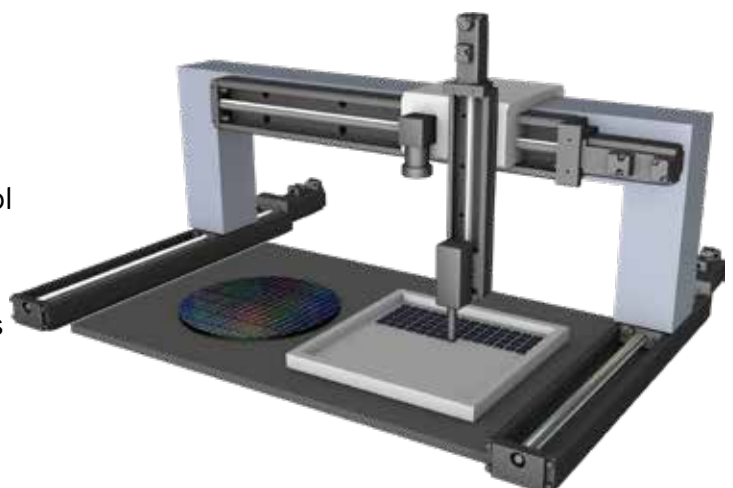

Machine Tool

- Low cogging torque for more stable machining
- Advanced friction compensation function for better performance when changing directions
- Two-degrees-of-freedom control architecture for optimized trajectory tracking

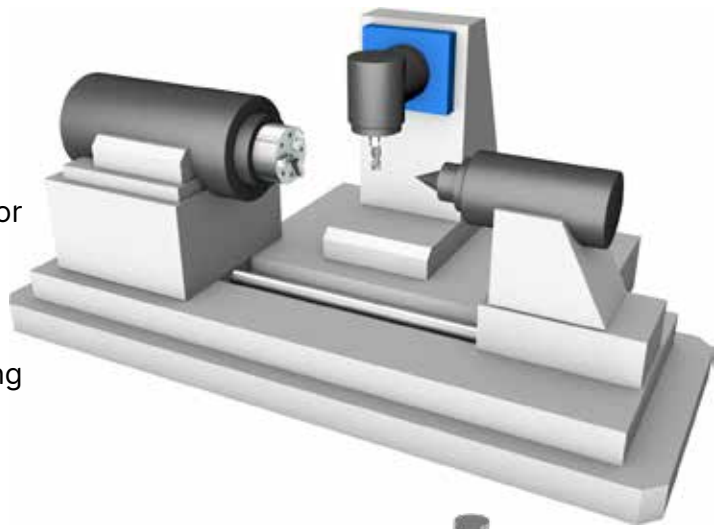

Diamond Cutting Machine

- High inertia motor facilitates the diamond polishing process with high precision and stability
- Low cogging torque for higher machining stability
- Two-degrees-of-freedom control architecture for optimized trajectory tracking

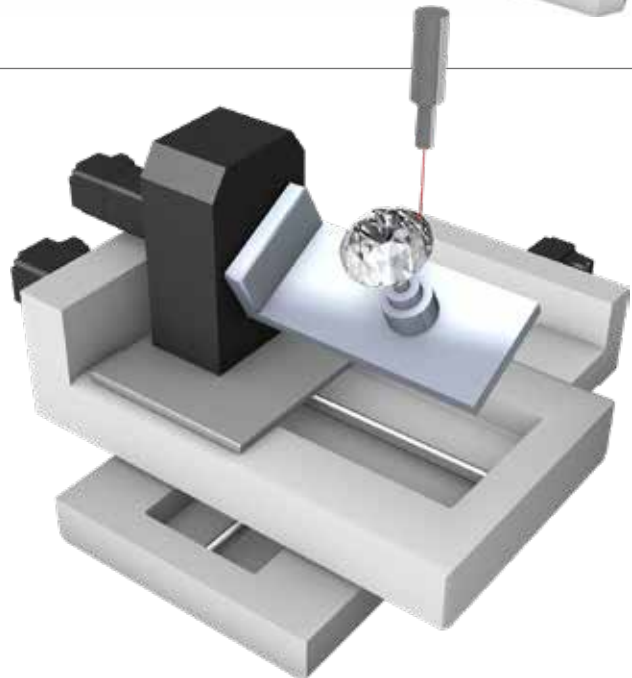

Winding Machine

- Communication type servo drives support the analog input function, facilitating multi-axis communication for tension control
- High-speed fieldbus with the communication cycle of 125 μ s for better synchronization between multiple axes
- Stable tension control with acceleration and deceleration S-curve

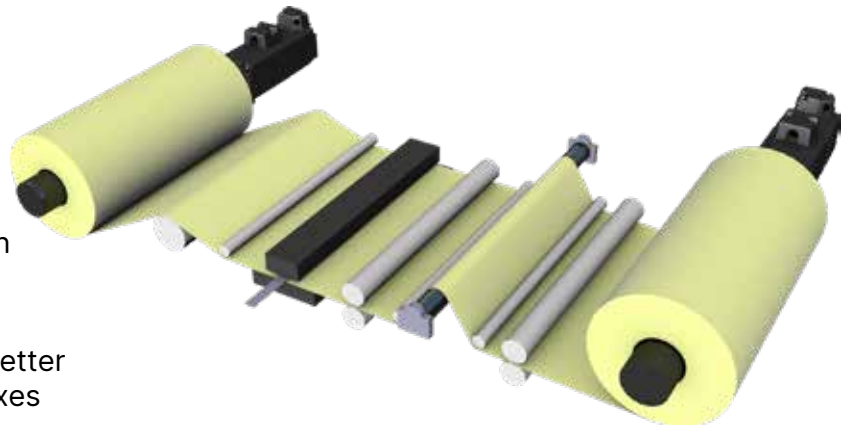

Servo Drive & Accessories



Power Supply
 220V
 100 W - 1.5 kW Single / Three-phase 200 - 230V
 2 kW - 3 kW Three-phase 200 - 230V
 400V
 1 - 7.5kW Three-phase 380 - 440V



No Fuse Braker (NFB)
 Protects the drive from instant maximum current due to power ON/OFF or electrical shorts



Magnetic Contactor (MC)
 When an anomaly occurs, the ALARM notification output by the servo drive can control the magnetic contactor to cut off the power.

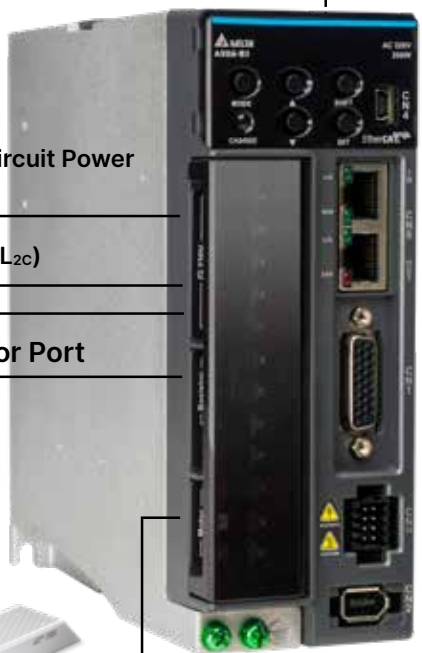

3 Main Circuit Power (RST)

4 Control Circuit (L1c L2c)

5 Regenerative Resistor Port (P⊙DC)

Regenerative Resistor

6 Servo Drive Output (UVW)
 Power Connector (P.58)
 Power Cable (P.59 - P.62)



1

2



8 Mini USB Port (CN4)
 Connects PC for software operation
 Connects with ASDA-SOFT with standard USB Mini connection cable
 Mini USB Communication Module (P.67)



9 COM Port Connector (CN3/CN6)
 CN3 CANopen Communication Cable (P.64)
 CN3 CANopen Distribution Box (P.65)
 CN3 RS-485 Tap (P.65)
 CN3 RS-485 / CANopen Terminal Resistor (P.66)
 CN6 DMCNET Terminal Resistor (P.66)



10 I/O Connector (CN1)
 Terminal Block Module (P.64)
 CN1 Connector (P.65)
 CN1 Quick Connector (P.65)



11 STO (CN10)
 B3A models only



12 Encoder Connector (CN2)
 Encoder Connector (P.62)
 Encoder Cable- Incremental Type (P.62)
 Encoder Cable- Absolute Type (P.63)



Note: Under high-interference environment, installing a USB isolator is recommended (Delta's product model: UC-ADP01-A)

Servo Drive Interface

No.	Name	Description
①	-	7-segment display
②	CHARGE	Power indicator
③	RST	Main circuit terminal; connects to the power supply (200 - 230 V _{AC} , 50/60 Hz)
④	L1c, L2c	Control circuit terminal; connects to single-phase power supply (200 - 230 V _{AC} , 50/60 Hz)
⑤	Regenerative Resistor	Connects to an external regenerative resistor, external regenerative braking unit, or the built-in regenerative resistor
⑥	UVW	Servo drive current output; connects to the motor power connector U, V, W. Do not connect to the main circuit power. Incorrect wiring will cause damage to the servo drive.
⑦	Ground Terminal	Connects to the ground wire for the power and servo motor
⑧	CN4	USB connector (Mini USB); connects to PC
⑨	CN3	Modbus communication port (B3-L/B3A-L)
	CN3	CANopen high-speed communication port (B3-M/B3A-M)
	CN6	DMCNET high-speed communication port (B3-F/B3A-F)
	CN6	EtherCAT high-speed communication port (B3-E/B3A-E)
⑩	CN1	I/O signal interface; connects to the PLC or controls I/O
⑪	CN10	STO connector; only available on B3A models
⑫	CN2	Encoder connector; connects to the encoder of the servo motors

Accessories

Power Cables

- 3 m, 5 m, 10 m, and 20 m standard cables are available
- Standard power connectors and IP67 waterproof connectors are available
- With options of brake and without brake

Encoder Cables

- 3 m, 5 m, 10 m, and 20 m standard cables are available
- Standard encoder connectors and IP67 waterproof connectors are available

USB Cables

- Connects the PC and the servo drive for ASDA-Soft operation
- Mini USB Type B communication port, compatible with USB 2.0

Regenerative Resistor

- Refer to Section 2.8 in the ASDA-B3 user manual for selection

Note: Under high-interference environment, installing a USB isolator is recommended (Delta's product model: UC-ADP01-A)

Servo System Combination Table

220V

		Motor					Drive		Power Cable			
Type	Power Supply	Output (W)	Model Name	Rotational Inertia (x10 ⁻⁴ kg.m ²)	Rated / Max. Speed (rpm)	Rated / Max. Torque (N-m)	Model Name	Standard	Torsion-resistant			
				Standard / With Brake								
Low Inertia	ECM-A3L	Single- / Three-phase	100	ECM-A3L-C ² 0401 ³ 4 ⁴ 5	0.04/0.0426	3000/6000	0.32/1.12	ASD-B3 ¹ -0121- ²	ACS3-CAPW11xx ACS3-CAPW51xx ^W	ACS3-CAPF11xx ACS3-CAPF51xx ^W		
			200	ECM-A3L-C ² 0602 ³ 4 ⁴ 5	0.09/0.12		0.64/2.24	ASD-B3 ¹ -0221- ²				
			400	ECM-A3L-C ² 0604 ³ 4 ⁴ 5	0.15/0.18		1.27/4.45	ASD-B3 ¹ -0421- ²				
			400	ECM-A3L-C ² 0804 ³ 4 ⁴ 5	0.352/0.408		1.27/4.44	ASD-B3 ¹ -0421- ²				
			750	ECM-A3L-C ² 0807 ³ 4 ⁴ 5	0.559/0.614		2.39/8.36	ASD-B3 ¹ -0721- ² ASD-B3 ¹ -1021- ²				
High Inertia	ECM-A3H	Single- / Three-phase	100	ECM-A3H-C ² 0401 ³ 4 ⁴ 5	0.0754/0.0816	3000/6000	0.32/1.12	ASD-B3 ¹ -0121- ²			ACS3-CAPW11xx ACS3-CAPW51xx ^W	ACS3-CAPF11xx ACS3-CAPF51xx ^W
			200	ECM-A3H-C ² 0602 ³ 4 ⁴ 5	0.25/0.28		0.64/2.24	ASD-B3 ¹ -0221- ²				
			400	ECM-A3H-C ² 0604 ³ 4 ⁴ 5	0.45/0.48		1.27/4.45	ASD-B3 ¹ -0421- ²				
			400	ECM-A3H-C ² 0804 ³ 4 ⁴ 5	0.92/1.07		1.27/4.44	ASD-B3 ¹ -0421- ²				
			750	ECM-A3H-C ² 0807 ³ 4 ⁴ 5	1.51/1.66		2.39/8.36	ASD-B3 ¹ -0721- ² ASD-B3 ¹ -1021- ²				
Medium Inertia	ECM-B3M	Single- / Three-phase	100	ECM-B3M-C ² 0401 ³ 4 ⁴ 5	0.0299/0.0315	2000/3000	0.32/1.12	ASD-B3 ¹ -0121- ²	ACS3-CAPWA2xx ^S ^W ACS3-CRPWA2xx ^R ^W	ACS3-CAPFA2xx ^S ^W ACS3-CRPFA2xx ^R ^W		
			200	ECM-B3M-C ² 0602 ³ 4 ⁴ 5	0.141/0.151		0.64/2.24	ASD-B3 ¹ -0221- ²				
			400	ECM-B3M-C ² 0604 ³ 4 ⁴ 5	0.254/0.264		1.27/4.45	ASD-B3 ¹ -0421- ²				
			400	ECM-B3M-C ² 0804 ³ 4 ⁴ 5	0.648/0.695		1.27/4.45	ASD-B3 ¹ -0421- ²				
			750	ECM-B3M-C ² 0807 ³ 4 ⁴ 5	1.07/1.13		2.4/8.4	ASD-B3 ¹ -0721- ²				
			1000	ECM-B3M-C ² 0810 ³ 4 ⁴ 5	1.37/1.4		3.18/11.13	ASD-B3 ¹ -0721- ² ASD-B3 ¹ -1021- ²				
			1000	ECM-B3M-C ² 1010 ³ 4 ⁴ 5	2.78/3.06		3.18/9.54	ASD-B3 ¹ -1021- ²				
			1000	ECM-B3M-E ² 1310 ³ 4 ⁴ 5	7.79/7.94		4.77/14.3	ASD-B3 ¹ -1021- ²				
			1500	ECM-B3M-C ² 1015 ³ 4 ⁴ 5	3.69/3.97		3000/6000	4.77/14.3			ASD-B3 ¹ -1521- ²	
			1500	ECM-B3M-E ² 1315 ³ 4 ⁴ 5	11.22/11.37		2000/3000	7.16/21.48			ASD-B3 ¹ -1521- ² ASD-B3 ¹ -2023- ²	
High Inertia	ECM-B3H	Single- / Three-phase	850	ECM-B3H-F ² 1308 ³ 4 ⁴ 5	12.44/12.62	1500/4000	5.39/16.17	ASD-B3 ¹ -1021- ²	ACS3-CAPWA3xx ^S ^W ACS3-CRPWA3xx ^R ^W	ACS3-CAPFA3xx ^S ^W ACS3-CRPFA3xx ^R ^W		
			1300	ECM-B3H-F ² 1313 ³ 4 ⁴ 5	18/18.14		8.34/25.02	ASD-B3 ¹ -1521- ²				
			1800	ECM-B3H-F ² 1318 ³ 4 ⁴ 5	22.6/22.8		1500/4000	11.5/34.5			ASD-B3 ¹ -2023- ²	
Medium Inertia	ECM-B3M	Three-phase	2000	ECM-B3M-C ² 1020 ³ 4 ⁴ 5	4.68/4.95	3000/6000	6.37/19.1	ASD-B3 ¹ -2023- ²	ACS3-CAPWA3xx ^S ^W ACS3-CRPWA3xx ^R ^W	ACS3-CAPFA3xx ^S ^W ACS3-CRPFA3xx ^R ^W		
			2000	ECM-B3M-E ² 1320 ³ 4 ⁴ 5	14.65/14.8	2000/3000	9.55/28.65	ASD-B3 ¹ -2023- ²				
			2000	ECM-B3M-E ² 1820 ³ 4 ⁴ 5	29.11/30.38	2000/3000	9.55/28.65	ASD-B3 ¹ -2023- ²				
			3000	ECM-B3M-F ² 1830 ³ 4 ⁴ 5	1500/3000	19.11/57.29	ASD-B3 ¹ -3023- ²					
						53.63/54.9	ASD-B3 ¹ -3023- ²					

Note:

1. Model name with ^W = IP67 water-proof connector; ^D = drive connector; ^M = motor connector; ^S = straight connector; ^R = angular connector; ^B = single brake connector, power connector required

2. Cable model name: The "XX" stands for cable length. 03 = 3 m, 05 = 5 m, 10 = 10 m, 20 = 20 m.

3. Servo motor model name: ² = encoder type, ³ = type of shaft and oil seal, ⁴ = shaft diameter and connector type, ⁵ = special code.

4. Servo drive model name: ¹ = product series, ² = model code.

Connector & Cable						Connector Only (No Cable)		
Power Cable with Brake		Encoder Cable (Incremental Type)		Encoder Cable (Absolute Type)		Power Connector	Power Connector (with brake)/ Brake Connector	Encoder Connector
Standard	Torsion-resistant	Standard	Torsion-resistant	Standard	Torsion-resistant			
ACS3-CAPW21xx ACS3-CAPW61xx	ACS3-CAPF21xx ACS3-CAPF61xx	ACS3-CAEN01xx ACS3-CAEN11xx	ACS3-CAEF01xx ACS3-CAEF11xx	ACS3-CAEA01xx ACS3-CAEA11xx	ACS3-CAEB01xx ACS3-CAEB11xx	ASDBCAPW0000 ACS3-CNPW1A00	ASDBCAPW0100 ACS3-CNPW2A00	ACS3-CNENC200 + ACS3-CAEN0000 ACS3-CNEN2A00
ACS3-CABRA1xx ACS3-CRBRA1xx	ACS3-CABFA1xx ACS3-CRBFA1xx	ACS3-CAENA1xx ACS3-CRENA1xx	ACS3-CAEFA1xx ACS3-CREFA1xx	ACS3-CAEAA1xx ACS3-CREAA1xx	ACS3-CAEBA1xx ACS3-CREBA1xx	ACS3-CAPWA000 ACS3-CRPWA000	ACS3-CABRA000 ACS3-CRBRA000	ACS3-CNENC200 + ACS3-CAENA000 ACS3-CRENA000
						ACS3-CAPWC000 ACS3-CRPWC000		















































Servo System Combination Table

400V

		Motor					Drive		Power Cable				
Type	Power Supply	Output (W)	Model Name	Rotational Inertia ($\times 10^{-4} \text{kg}\cdot\text{m}^2$)	Rated / Max. Speed (rpm)	Rated / Max. Torque (N-m)	Model Name	Standard	Torsion-resistant				
				Standard / With Brake									
Medium Inertia	ECM-B3M	Three-phase	400	ECM-B3M-J 2 0604 3 4 5	0.254 / 0.264	3000 / 6000	1.27 / 4.45	ASD-B3 1 -1043- 2	ACS3-CAPW31xx	ACS3-CAPF31xx			
			750	ECM-B3M-J 2 0807 3 4 5	1.07 / 1.13		2.4 / 8.4	ASD-B3 1 -1043- 2 ASD-B3 1 -1543- 2					
			1000	ECM-B3M-J 2 1010 3 4 5	2.78 / 3.06	2000 / 3000	3.18 / 9.54	ASD-B3 1 -1043- 2 ASD-B3 1 -1543- 2	ACS3-CAPWA2xx 3 W ACS3-CRPWA2xx 3 W	ACS3-CAPFA2xx 3 W ACS3-CRPFA2xx 3 W			
			1500	ECM-B3M-J 2 1015 3 4 5	3.69 / 3.97		4.77 / 14.3	ASD-B3 1 -1543- 2 ASD-B3 1 -2043- 2					
			2000	ECM-B3M-J 2 1020 3 4 5	4.68 / 4.95		6.37 / 19.1	ASD-B3 1 -2043- 2					
			1000	ECM-B3M-K 2 1310 3 4 5	7.79 / 7.94	2000 / 3000	4.77 / 14.3	ASD-B3 1 -1043- 2 ASD-B3 1 -1543- 2	ACS3-CAPWA2xx 3 W ACS3-CRPWA2xx 3 W	ACS3-CAPFA2xx 3 W ACS3-CRPFA2xx 3 W			
			1500	ECM-B3M-K 2 1315 3 4 5	11.22 / 11.37		7.16 / 21.48	ASD-B3 1 -1543- 2 ASD-B3 1 -2043- 2					
			2000	ECM-B3M-K 2 1320 3 4 5	14.65 / 14.8		9.55 / 28.65	ASD-B3 1 -2043- 2					
			High Inertia	ECM-B3H	1500 / 4000	850	ECM-B3H-L 2 1308 3 4 5	12.44 / 12.62	1500 / 4000	5.39 / 16.17	ASD-B3 1 -1043- 2 ASD-B3 1 -1543- 2	ACS3-CAPWC3xx 3 W ACS3-CRPWC3xx 3 W	ACS3-CAPFC3xx 3 W ACS3-CRPFC3xx 3 W
						1300	ECM-B3H-L 2 1313 3 4 5	18 / 18.14		8.34 / 25.02	ASD-B3 1 -1543- 2 ASD-B3 1 -2043- 2		
1800	ECM-B3H-L 2 1318 3 4 5	22.6 / 22.8				11.5 / 34.5	ASD-B3 1 -2043- 2						
Medium Inertia	ECM-B3M	1500 / 4000	2000	ECM-B3M-K 2 1820 3 4 5	29.11 / 30.38	2000 / 3000	9.55 / 28.65	ASD-B3 1 -2043- 2	ACS3-CAPWC3xx 3 W ACS3-CRPWC3xx 3 W	ACS3-CAPFC3xx 3 W ACS3-CRPFC3xx 3 W			
			3000	ECM-B3M-L 2 1830 3 4 5	53.63 / 54.9	1500 / 3000	19.1 / 57.29	ASD-B3 1 -3043- 2 ASD-B3 1 -4543- 2					
			4500	ECM-B3M-L 2 1845 3 4 5	67.73 / 69.15	1500 / 4000	28.65 / 71.6	ASD-B3 1 -4543- 2	ACS3-CAPWC4xx 3 W ACS3-CRPWC4xx 3 W	ACS3-CAPFC4xx 3 W ACS3-CRPFC4xx 3 W			
			5500	ECM-B3M-L 2 1855 3 4 5	98.88 / 100.1		35.01 / 105	ASD-B3 1 -5543- 2	ACS3-CAPWE6xx 3 W ACS3-CRPWE6xx 3 W	ACS3-CAPFE6xx 3 W ACS3-CRPFE6xx 3 W			
			7500	ECM-B3M-L 2 1875 3 4 5	134.95 / 136.24		47.75 / 119	ASD-B3 1 -7543- 2					

Note:

- Model name with **W** = IP67 water-proof connector; **D** = drive connector; **M** = motor connector; **S** = straight connector; **R** = angular connector; **E** = single brake connector, power connector required
- Cable model name: The "XX" stands for cable length. 03 = 3 m, 05 = 5 m, 10 = 10 m, 20 = 20 m.
- Servo motor model name: **2** = encoder type, **3** = type of shaft and oil seal, **4** = shaft diameter and connector type, **5** = special code.
- Servo drive model name: **1** = product series, **2** = model code.

Connector & Cable						Connector Only (No Cable)		
Power Cable with Brake		Encoder Cable (Incremental Type)		Encoder Cable (Absolute Type)		Power Connector	Power Connector (with brake)/ Brake Connector	Encoder Connector
Standard	Torsion-resistant	Standard	Torsion-resistant	Standard	Torsion-resistant			
ACS3-CAPW21xx	ACS3-CAPF21xx	ACS3-CAEN01xx	ACS3-CAEF01xx	ACS3-CAEA01xx	ACS3-CAEB01xx	ASDBCAPW0000	ASDBCAPW0100	ACS3-CNENC200  + ACS3-CAEN0000 
ACS3-CABRA1xx   ACS3-CRBRA1xx  	ACS3-CABFA1xx   ACS3-CRBFA1xx  	ACS3-CAENA1xx   ACS3-CRENA1xx  	ACS3-CAEFA1xx   ACS3-CREFA1xx  	ACS3-CAEAA1xx   ACS3-CREAA1xx  	ACS3-CAEBA1xx   ACS3-CREBA1xx  	ACS3-CAPWA000   ACS3-CRPWA000  	ACS3-CABRA000   ACS3-CRBRA000  	ACS3-CNENC200  + ACS3-CAENA000   ACS3-CRENA000  
						ACS3-CAPWC000   ACS3-CRPWC000  		
						ACS3-CAPWE000   ACS3-CRPWE000  		

Servo Drive Model Information

ASD-B3 Series Servo Drive

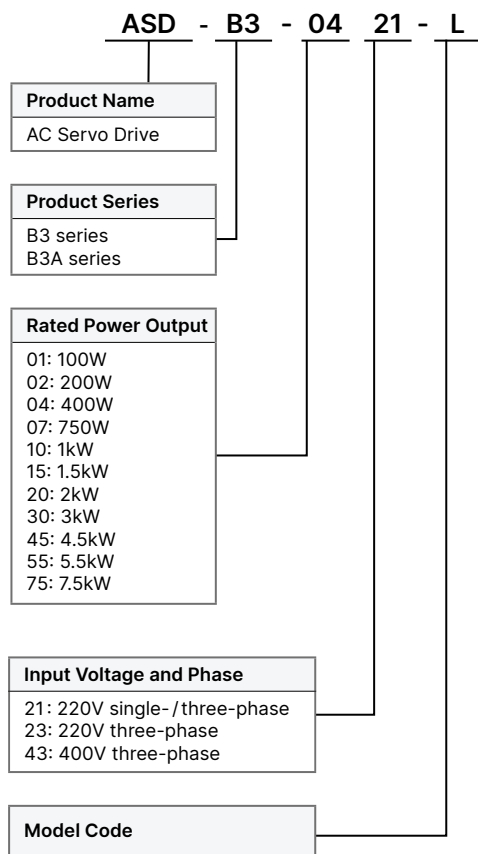

ASD-B3

Code	PT Mode Pulse Input	PR Mode	RS-485	Analog Voltage Control	CANopen	DMCNET	EtherCAT	STO
L	√	√	√	√	-	-	-	-
M	-	√	-	√	√	-	-	-
F	-	√	-	√	-	√	-	-
E	-	√	-	√	-	-	√	-

ASD-B3A*1

Code	PT Mode Pulse Input	PR Mode	RS-485	Analog Voltage Control	CANopen	DMCNET	EtherCAT	STO*2
L	√	√	√	√	-	-	-	√
M	√	√	√	√	√	-	-	√
F	√	√	-	√	-	√	-	√
E	√	√	-	√	-	-	√	√

*1. B3A supports dynamic brake function

*2. B3A 200V supports STO (SIL2); B3A 400V STO (SIL3) certification in process

Note: The model information is for reference only. Not all kinds of permutations are available. Please contact the distributor near your region or Delta for the details.



Servo Drive Specifications



ASD-B3			100 W	200 W	400 W	750 W	1kW	1.5kW	2kW	3kW	
			01	02	04	07	10	15	20	30	
Power Supply	Phase / Voltage		Single-phase / Three-phase 220V _{AC}						Three-phase 220V _{AC}		
	Permissible Voltage		Single-phase / Three-phase 200 ~ 230V _{AC} , -15% to 10%						Three-phase 200 ~ 230V _{AC} , -15% to 10%		
	Input Current (3PH) (Unit: Arms)		0.88	1.29	2.04	3.52	5.72	6.33	7.6	10.3	
	Input Current (1PH) (Unit: Arms)		1.47	2.35	3.74	6.47	10.4	11.7	-	-	
	Continuous Output Current (Unit: Arms)		0.9	1.55	2.65	5.1	7.3	8.3	13.4	19.4	
Max. Instantaneous Output Current (Unit: Arms)		3.88	7.07	10.6	14.14	21.21	24.3	38.3	53.03		
Regenerative Resistor	Built-in Regenerative Resistor	Resistance (Ohm)	-	-	100	100	100	100	20	20	
		Capacity (Watt)	-	-	40	40	40	40	80	80	
	External Minimum Allowable Resistance Value(Ohm)		60	60	60	60	30	30	15	15	
Cooling Method		Natural cooling					Fan cooling				
Drive Resolution		24-bit (16,777,216 pls/rev)									
Main Circuit Control		SVPWM control									
Tuning Mode		Auto / Manual									
Regenerative Resistor		N/A			Built-in						
Position Control Mode	Pulse Type (only for pulse control mode)		Pulse + Direction; A phase + B phase; CCW pulse + CW pulse								
	Max. Output Pulse Frequency (only for pulse control mode)		Pulse + direction: 4 Mpps; CCW pulse + CW pulse: 4 Mpps; A phase + B phase: single-phase 2 Mpps; Open collector: 200 Kpps								
	Command Source		External pulse (only for pulse control mode) / Internal register (PR mode)								
	Smoothing Method		Low-pass, S-curve, and moving filters								
	E-Gear Ratio		E-Gear ratio: N / M times, limited to (1 / 4 < N / M < 262144) N: 1 - 536870911 / M: 1 - 2147483647								
	Torque Limit		Parameter settings								
Feed Forward Compensation		Parameter settings									
Speed Control Mode	Analog Command Input	Voltage Range	0 to ±10 V _{DC}								
		Resolution	12-bit								
		Input Impedance	1MΩ								
		Time Constant	25 μs								
	Speed Control Range ¹		1 : 6000								
	Command Source		External analog command / Internal register								
	Smoothing Method		Low-pass and S-curve filters								
Torque Control Mode	Analog Command Input	Voltage Range	0 to ±10 V _{DC}								
		Input Impedance	1 MΩ								
		Time Constant	25 μs								
	Command Source		External analog command / Internal register								
Smoothing Method		Low-pass filter									
Speed Limit		Parameter settings or analog input									
Analog Monitor Output		Monitoring signal can be set with parameters (voltage output range: ±8V); resolution: 10-bit									
Digital Input / Output	Input		Servo on, Fault reset, Gain switch, Pulse clear, Zero speed clamping, Command input reverse control, Internal position command trigger, Torque limit, Speed limit, Internal position command selection, Motor stop, Speed command selection, Speed / Position mode switching, Speed / Torque command switching, Torque / Position mode switching, PT / PR command switching, Emergency stop, Forward / reverse limit, Original point, Forward / reverse operation torque limit, Homing activated, Forward / reverse JOG input, Event trigger, E-Gear N selection, Pulse input prohibition *The DI mentioned above are only used in pulse control mode. When controlling through communication, it is suggested that you use communication for DI input. DI only supports emergency stop, forward / reverse limit, and homing.								
	Output		A, B, Z line driver output Servo ready, Servo on, Zero speed detection, Target speed reached, Target position reached, Torque limiting, Servo alarm, Magnetic brake control, Homing complete, Early warning for overload, Servo warning, Position command overflows, Software limit (reverse direction), Software limit (forward direction), Internal position command complete, Servo procedure complete, Capture procedure complete								
Protection Function		Overcurrent, Overvoltage, Undervoltage, Overheat, Regeneration error, Overload, Excessive speed deviation, Excessive position deviation, Encoder error, Adjustment error, Emergency stop, Forward / reverse limit error, Serial communication error, RST leak phase, Serial communication timeout, Short-circuit protection for terminals U, V, W									
Communication Interface		USB / RS-485 / CANopen / DMCNET / EtherCAT									
Environment	Installation Site		Indoors (avoid direct sunlight), no corrosive vapor (avoid fumes, flammable gases, and dust)								
	Altitude		Altitude 2000 m or lower above sea level								
	Atmospheric Pressure		86 kPa - 106 kPa								
	Operating Temperature		0°C to 55°C (If operating temperature is above 45°C, forced cooling is required)								
	Storage Temperature		-20°C to 65°C								
	Humidity		0 to 90% RH (non-condensing)								
	Vibration		10 Hz ~ 57 Hz : 0.075 mm amplitude ; 58 Hz ~ 150 Hz : 1G								
	IP Rating		IP20								
Power System		TN system ^{*3*4}									
Certifications		IEC/EN/UL 61800-5-1 									

Notes:

- *1. Within the rated load, the speed ratio is: the minimum speed (smooth operation) / rated speed.
- *2. Within the rated speed, the speed calibration ratio is: (rotational speed with no load - rotational speed with full load) / rated speed.
- *3. TN system: the neutral point of the power system connects directly to the ground.
The exposed metal components connect to the ground through the protective ground conductor.
- *4. Use a single-phase three-wire power system for the single-phase power model.
- *5. ASDA-B3A complies with the TUV Functional Safety certification.

Servo Drive Specifications

400 V

ASD-B3		1kW	1.5kW	2kW	3kW	4.5kW	5.5kW	7.5kW	
		10	15	20	30	45	55	75	
Main Circuit Power Supply	Phase / Voltage		Three-phase 400 V _{AC}						
	Permissible Voltage		Three-phase 380 - 440 V _{AC} , -10% - +10%						
	Input Current (3PH) (Unit: Arms)		2.91	3.52	5.06	6.14	12	14.5	20
	Inrush Current (Unit: Arms)		5.66	5.66	5.66	5.66	37.72	37.72	37.72
Control Power Supply	Phase / Voltage		Single-phase 400 V _{AC}						
	Permissible Voltage		Single-phase 380 - 400 V _{AC} , -10% - +10%						
	Input Current (3PH) (Unit: Arms)		0.1	0.1	0.1	0.1	0.13	0.13	0.13
	Input Current (1PH) (Unit: Arms)		37.72	37.72	37.72	37.72	37.72	37.72	37.72
Continuous Output Current (Unit: Arms)		3.37	4.09	5.96	9.11	13.3	15.34	22.11	
Max. Instantaneous Output Current (Unit: Arms)		7.07	10.6	18.98	27.33	35.35	49.29	53.03	
Regenerative Resistor	Built-in Regenerative Resistor	Resistance (Ohm)	100	100	50	50	35	35	35
		Capacity (Watt)	80	80	80	80	100	100	100
	External Minimum Allowable Resistance Value (Ohm)		80	60	45	40	35	25	25
Cooling Method		Fan cooling							
Drive Resolution		24-bit (16777216 p/rev)							
Main Circuit Control		SVPW Mcontrol							
Tuning Mode		Auto / Manual							
Position Control Mode	Pulse Type (only for pulse control mode)		Pulse + Direction; A phase + B phase; CCW pulse + CW pulse						
	Max. Output Pulse Frequency (only for pulse control mode)		Pulse + direction: 4 Mpps; CCW pulse + CW pulse: 4 Mpps; A phase + B phase: single-phase 2 Mpps; Open collector: 200 Kpps						
	Command Source		External pulse (only for pulse control mode) / Internal register (PR mode)						
	Smoothing Method		Low-pass, S-curve, and moving filters						
	E-Gear Ratio		E-Gear ratio: N / M times, limited to (1/4 < N/M < 262144) N: 1-536870911 / M: 1-2147483647						
	Torque Limit		Parameter settings						
	Feed Forward Compensation		Parameter settings						
Speed Control Mode	Analog Command Input	Voltage Range	0 - ± 10 V _{DC}						
		Resolution	12-bit						
		Input Impedance	1 MΩ						
		Time Constant	25 μs						
	Speed Control Range ¹		1:6000						
	Command Source		External analog command / Internal register						
	Smoothing Method		Low-pass and S-curve filters						
	Torque Limit		Parameter settings or analog input						
Bandwidth		Maximum 3.1 kHz							
Speed Calibration Ratio ²		± 0.01% at 0% to 100% load fluctuation							
		± 0.01% at ± 10% power fluctuation							
		± 0.01% at 0°C to 50°C ambient temperature fluctuation							
Torque Control Mode	Analog Command Input	Voltage Range	0 - ± 10 V _{DC}						
		Input Impedance	1 MΩ						
		Time Constant	25 μs						
	Command Source		External analog command / Internal register						
	Smoothing Method		Low-pass filter						
Speed Limit		Parameter settings or analog input							
Analog Monitor Output		Monitoring signal can be set with parameters (voltage output range: ± 8V); resolution: 10-bit							
Digital Input		L: 9 Inputs; M, F, E: 4 Inputs							
Digital Output		L: 6 Outputs; M, F, E: 2 Outputs							
Protection Function		Overcurrent, Overvoltage, Undervoltage, Overheat, Regeneration error, Overload, Excessive speed deviation, Excessive position deviation, Encoder error, Adjustment error, Emergency stop, Forward / reverse limit error, Serial communication error, RST leak phase, Serial communication timeout, Short-circuit protection for terminals U, V, W							
Communication Interface		RS-485 / USB / CANopen / DMCNET / EtherCAT							
Environment	Installation Site		Indoors (avoid direct sunlight), no corrosive vapor (avoid fumes, flammable gases, and dust)						
	Altitude		Altitude 2000 m or lower above sea level						
	Atmospheric Pressure		86kPa - 106kPa						
	Operating Temperature		0°C - 55°C (If operating temperature is above 45°C, forced cooling is required)						
	Storage Temperature		-20°C - 65°C						
	Humidity		0 - 90% RH (non-condensing)						
	Vibration		0Hz - 57Hz: 0.075 mm amplitude, 58Hz - 150Hz: 1G						
	IP Rating		IP20						
	Power System		TN system ^{*3+4}						
	Certifications		IEC/EN 61800-5-1   						

Notes:

*1. Within the rated load, the speed ratio is: the minimum speed (smooth operation) / rated speed

*2. Within the rated speed, the speed calibration ratio is: (rotational speed with no load - rotational speed with full load) / rated speed

*3. TN system: the neutral point of the power system connects directly to the ground. The exposed metal components connect to the ground through the protective ground conductor

*4. Use a single-phase three-wire power system for the single-phase power model

*5. B3A TUV Functional Safety certification in process

Dimensions - 220 V

100 W / 200 W / 400 W

Weight	Unit
0.9kg	mm (inch)

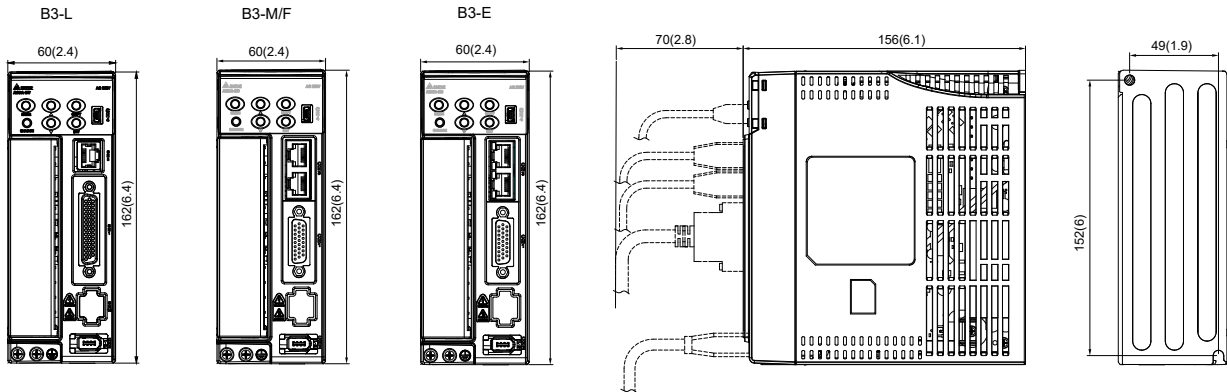

750 W

Weight	Unit
1.2kg	mm (inch)

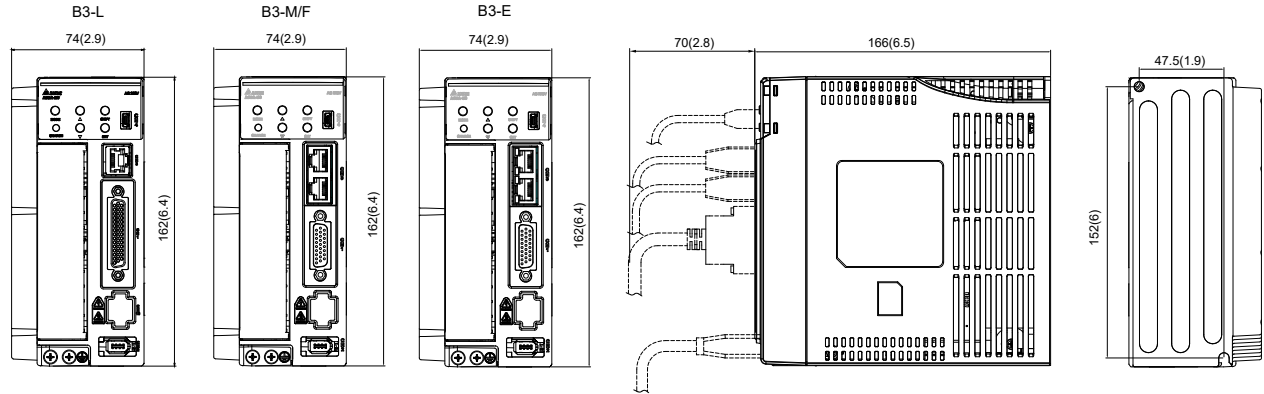

1kW/1.5kW

Weight	Unit
1.8kg	mm (inch)

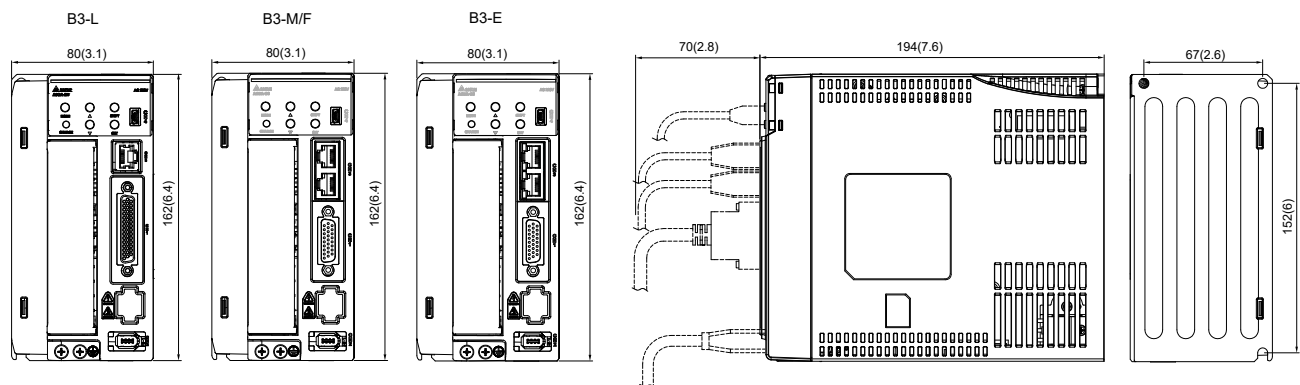

Servo Drive Specifications

Dimensions - 220 V

2kW/3kW

Weight	Unit
2.8 kg	mm (inch)

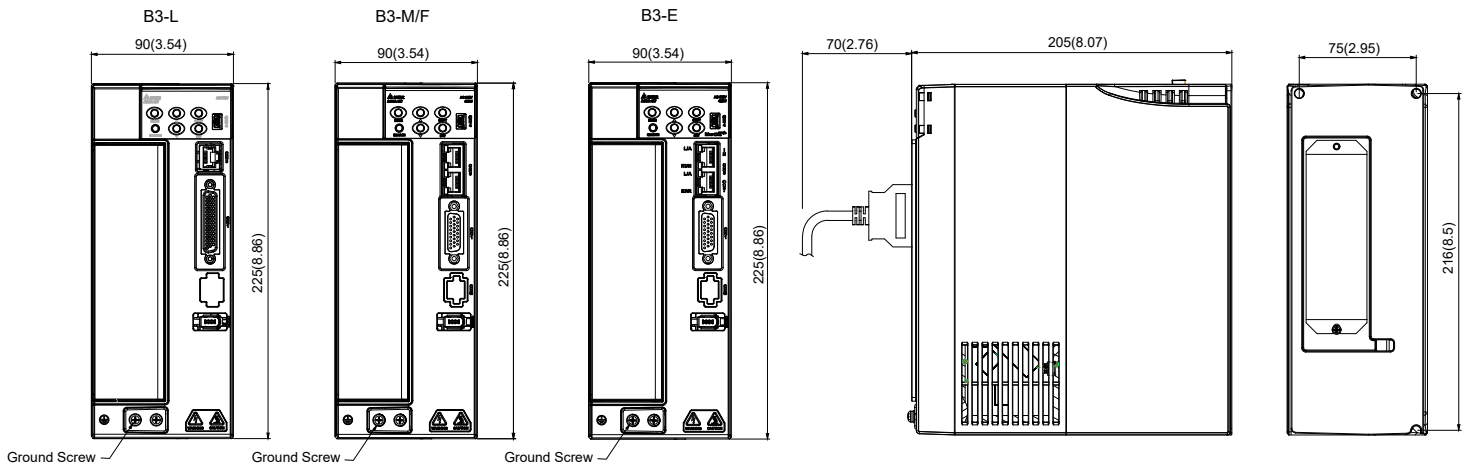

Dimensions - 400 V

2kW/3kW

	Weight	Unit
1 kW/1.5 kW	1.6 kg	mm (inch)
2 kW/3 kW	1.7 kg	mm (inch)

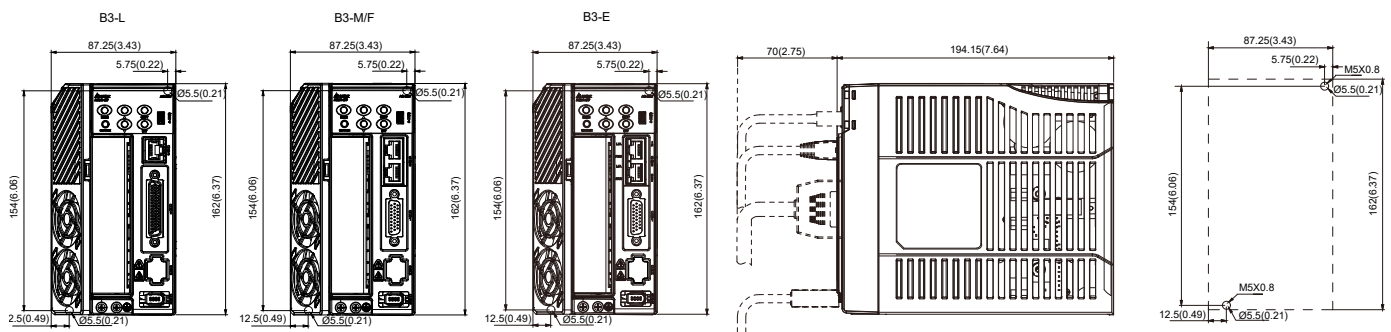

Dimensions - 400V

4.5 kW / 5.5 kW / 7.5 kW

Weight	Unit
2.9 kg	mm (inch)

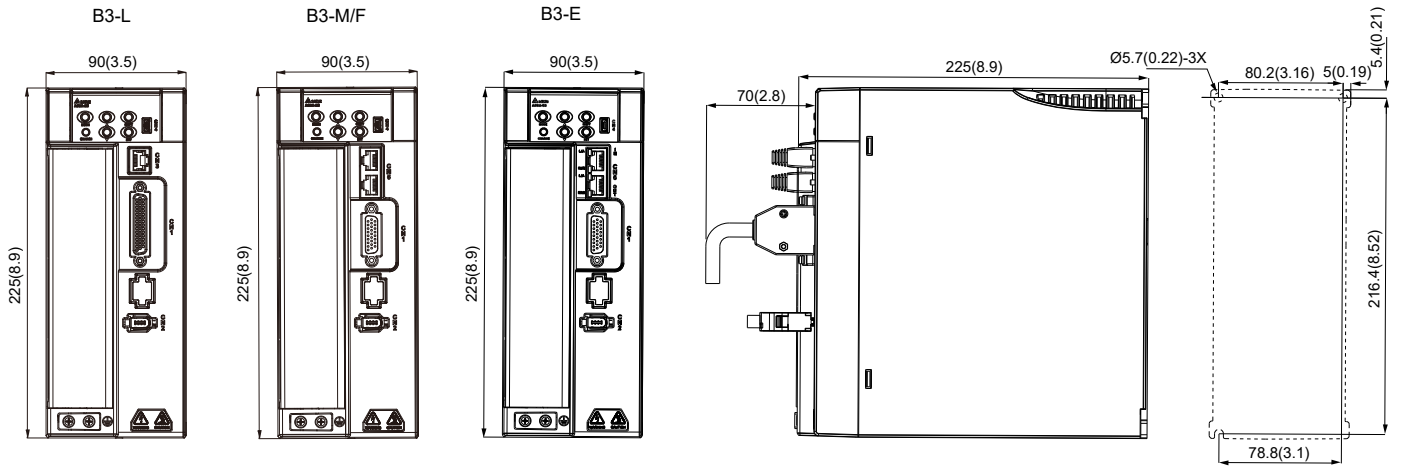

Servo Motor Model Information

ECM-B3 Series Servo Motor

ECM - B3 M - C A 06 04 R S 1

Product Name
ECM:
Electronic
Commutation
Motor

Series
B3 series

Inertia
H: High inertia
M: Medium inertia
L: Low inertia

Rated Voltage and Speed
C: 220V/3000 rpm
E: 220V/2000 rpm
F: 220V/1500 rpm
J: 400V/3000 rpm
K: 400V/2000 rpm
L: 400V/1500 rpm

Encoder Type
A: 24-bit absolute optical encoder
Resolution of single turn: 24-bit
Resolution of multiple turns: 16-bit
2: 24-bit incremental optical encoder
P: 17-bit absolute magnetic optical encoder
Resolution of single turn: 17-bit
Resolution of multiple turns: 16-bit
M: 17-bit incremental magnetic optical encoder

Motor Frame Size
04 : 40 mm 06 : 60 mm
08 : 80 mm 10 : 100 mm
13 : 130 mm 18 : 180 mm

Rated Power Output
01 : 100 W 02 : 200 W
04 : 400 W 07 : 750 W
08 : 850 W 10 : 1 kW
13 : 1.3 kW 15 : 1.5 kW
18 : 1.8 kW 20 : 2 kW
30 : 3 kW 45 : 4.5 kW
55 : 5.5 kW 75 : 7.5 kW

Type of Shaft and Oil Seal	w/o Brake w/o Oil Seal	with Brake w/o Oil Seal	w/o Brake with Oil Seal	with Brake with Oil Seal
Round Shaft (with fixed screw holes)	-	-	C*	D*
Keyway (with fixed screw holes)	P*	Q*	R	S

Note: Models with an * are coming soon.

Shaft Diameter
S: Standard connector and standard shaft diameter
7: Standard connector and special shaft diameter (14 mm)*
J: IP67 waterproof connector and standard shaft diameter
K: IP67 waterproof connector and special shaft diameter (14 mm)*

*Shafts of special diameter are used for 400 W motors with the frame size of 80 mm

Special Code
1: Standard products

ECM-A3 Series Servo Motor

ECM - A3 H - C Y 06 04 R S 1

Product Name
ECM :
Electronic
Commutation
Motor

Series
A3 series

Inertia
H: High inertia
L: Low inertia

Rated Voltage and Speed
C: 220V/3000rpm

Encoder Type
Y: 24-bit absolute optical encoder
Resolution of single turn: 24-bit
Resolution of multiple turns^{*1}:
1: 24-bit incremental optical encoder^{*2}
A: 24-bit absolute magnetic optical encoder
Resolution of single turn: 24-bit
Resolution of multiple turns^{*1}: 16-bit
2: 24-bit incremental magnetic optical encoder^{*2}

*1. Number of turns

*2. Can be used as a single-turn absolute encoder

Motor Frame Size
04 : 40mm 06 : 60mm
08 : 80mm

Rated Power Output
0F : 50W 01 : 100W
02 : 200W 04 : 400W
07 : 750W

Type of Shaft and Oil Seal	w/o Brake w/o Oil Seal	with Brake w/o Oil Seal	w/o Brake with Oil Seal	with Brake with Oil Seal
Round Shaft (with fixed screw)	-	-	C	D
Keyway (with fixed screw holes)	P*	Q*	R	S

*Not standing models

Shaft Diameter
S: Standard connector and standard shaft diameter
7: Standard connector and special shaft diameter (14 mm)*
J: IP67 waterproof connector and standard shaft diameter
K: IP67 waterproof connector and special shaft diameter (14 mm)*

*Shafts of special diameter are used for 400 W motors with the frame size of 80 mm

Special Code
1: Standard products
Z: Refer to the note for dimensions on page 49

ECM-B3 Series Servo Motor Specifications

Electrical Specifications - 220 V

Motor with Frame Size of 80 mm or below Low Inertia Motor ECM-B3L Series / Medium Inertia Motor ECM-B3M Series

	ECM-B3L-C[2]0401 ^{†1}	ECM-B3M-C[2]0602 ^{†1}	ECM-B3M-C[2]0604 ^{†1}	ECM-B3M-C[2]0804 ^{†1}
Rated Power (kW)	0.1	0.2	0.4	0.4
Rated Torque (N-m) ^{*2}	0.32	0.64	1.27	1.27
Maximum Torque (N-m)	1.12	2.24	4.45	4.45
Rated Speed (rpm)	3000			
Maximum Speed (rpm)	6000			
Rated Current (Arms)	0.857	1.42	2.40	2.53
Max. Instantaneous Current (Arms)	3.44	6.62	9.47	9.42
Rated Power Rate (kW/s)	34.25	29.05	63.50	24.89
Rated Power Rate (kW/s) with brake	32.51	27.13	61.09	23.21
Rotor Inertia ($\times 10^{-4}$ kg.m ²)	0.0299	0.141	0.254	0.648
Rotor Inertia ($\times 10^{-4}$ kg.m ²) with brake	0.0315	0.151	0.264	0.695
Mechanical Time Constant (ms)	0.50	0.91	0.52	0.8
Mechanical Time Constant (ms) with brake	0.53	0.97	0.54	0.86
Torque Constant -KT (N-m/A)	0.374	0.45	0.53	0.5
Voltage Constant -KE (mV/(rpm))	13.8	16.96	19.76	18.97
Armature Resistance (Ohm)	8.22	4.71	2.04	1.125
Armature Inductance (mH)	19.1	12.18	6.50	5.14
Electrical Time Constant (ms)	2.32	2.59	3.19	4.57
Weight – without brake (kg)	0.5	0.9	1.2	1.7
Weight – with brake (kg)	0.7	1.3	1.6	2.51
Max. Radial Loadin (N) ^{*5}	78	245	245	392
Max. Axial Loading (N) ^{*5}	54	74	74	147
Brake working voltage	24 V _{DC} \pm 10%			
Brake Power Consumption (at 20°C)[W]	6.1	7.6	7.6	8
Brake Holding Torqu [Nt-m (min)] ^{*3}	0.3	1.3	1.3	2.5
Brake Release Time [ms (Max)]	20	20	20	20
Brake Pull-In Time [ms (Max)]	35	50	50	60
Derating (%) (with oil seal)	10	10	5	5

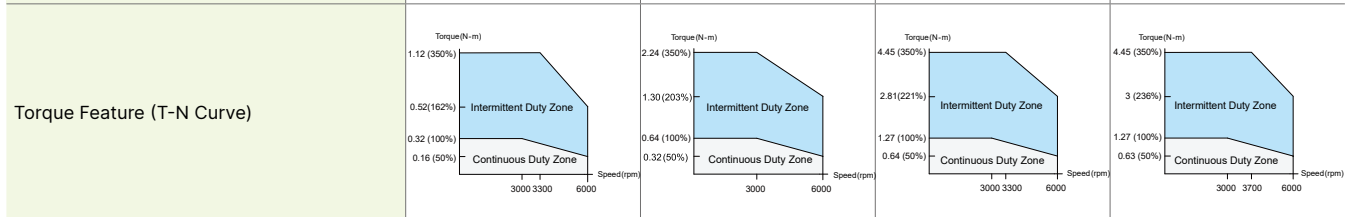

Insulation Class	Class A (UL), Class B (CE)
Insulation Resistance	> 100 M Ω , DC 500V
Insulation Strength	1.8 kVac, 1 sec
Vibration Level (μ m)	V15
Operating Temperature	-20°C - 60°C ^{*4}
Storage Temperature	-20°C - 80°C ^{*4}
Storage & Operation Humidity	20 - 90%RH (non-condensing)
Vibration Capacity	2.5 G
IP Rating	IP67 (when using waterproof connections and when an oil seal is fitted to the rotating shaft (for an oil seal model))
Certifications	

- Notes:
- In the servo motor model name, [1] represents the motor inertia and [2] represents the encoder type.
 - The rated torque is the continuous permissible torque between 0 to 40°C operating temperature which is suitable for the servo motor mounted with the following heat sink dimensions.
F40, F60, F80: 250 mm x 250 mm x 6 mm
Material: aluminum
 - The built-in servo motor brake is only for keeping the object in a stopped state.
Do not use it for deceleration or as a dynamic brake
 - If the operating temperature is over 40°C, refer to the power derating curves of B3 motors on page 37.
 - Please follow the max. tolerant loading of the motor shaft end listed below during operation

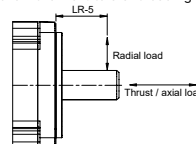

ECM-B3 Series Servo Motor Specifications

Electrical Specifications - 200 V

Motor with Frame Size of 80 / 100 Medium Inertia Motor ECM-B3M Series

	ECM-B3M-C 2 0807	ECM-B3M-C 2 0810	ECM-B3M-C 2 1010	ECM-B3M-C 2 1015
Rated Power (kW)	0.75	1	1	1.5
Rated Torque (N-m) ^{*2}	2.4	3.18	3.18	4.77
Maximum Torque (N-m)	8.4	11.13	9.54	14.3
Rated Speed (rpm)	3000			
Maximum Speed (rpm)	6000			
Rated Current (Arms)	4.27	5	6.05	7.48
Max. Instantaneous Current (Arms)	15.8	18.2	18.4	22.8
Rated Power Rate (kW/s)	53.83	73.8	36.4	61.7
Rated Power Rate (kW/s) with brake	50.97	72.2	33	57.3
Rotor Inertia ($\times 10^{-4}$ kg.m ²)	1.07	1.37	2.78	3.69
Rotor Inertia ($\times 10^{-4}$ kg.m ²) with brake	1.13	1.4	3.06	3.97
Mechanical Time Constant (ms)	0.54	0.48	0.741	0.552
Mechanical Time Constant (ms) with brake	0.57	0.49	0.815	0.594
Torque Constant -KT (N-m/A)	0.56	0.64	0.526	0.638
Voltage Constant -KE (mV/(rpm))	20.17	23.15	19.8	23.8
Armature Resistance (Ohm)	0.55	0.495	0.265	0.217
Armature Inductance (mH)	2.81	2.63	1.86	1.71
Electrical Time Constant (ms)	5.11	5.31	7.02	7.88
Weight – without brake (kg)	2.34	2.82	3.56	4.37
Weight – with brake (kg)	3.15	3.6	4.88	5.68
Max. Radial Loadin (N) ^{*5}	392	392	490	490
Max. Axial Loading (N) ^{*5}	147	147	196	196
Brake working voltage	24 V _{DC} \pm 10%	24 V _{DC} \pm 10%	24 V _{DC} \pm 10%	
Brake Power Consumption (at 20°C)[W]	8	10	17.6	17.6
Brake Holding Torqu [Nt-m (min)] ^{*3}	2.5	3.8	9.5	9.5
Brake Release Time [ms (Max)]	20	40	50	50
Brake Pull-In Time [ms (Max)]	60	80	110	110
Derating (%) (with oil seal)	5	40	5	5

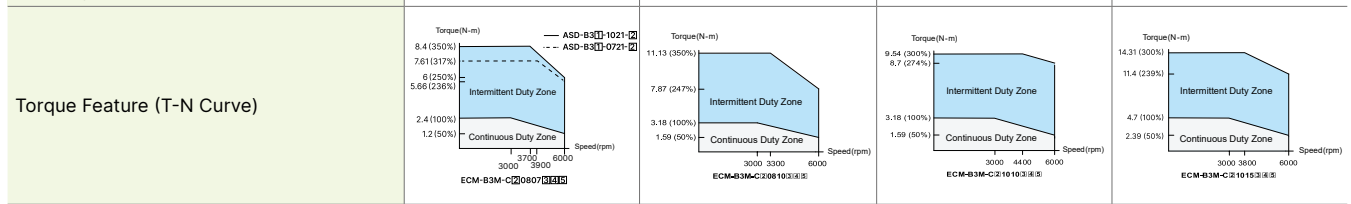

Insulation Class	Class A (UL), Class B (CE)
Insulation Resistance	> 100 MΩ, DC 500V
Insulation Strength	1.8 kVac, 1 sec
Vibration Level (μm)	V15
Operating Temperature	-20°C - 60°C*4
Storage Temperature	-20°C - 80°C*4
Storage & Operation Humidity	20 - 90%RH (non-condensing)
Vibration Capacity	2.5 G
IP Rating	IP67 (when using waterproof connections and when an oil seal is fitted to the rotating shaft (for an oil seal model))
Certifications	

- Notes:
- In the servo motor model name, 2 represents the encoder type.
 - The rated torque is the continuous permissible torque between 0 to 40°C operating temperature which is suitable for the servo motor mounted with the following heat sink dimensions.
F80: 250 mm x 250 mm x 6 mm
F100: 300 mm x 300 mm x 12 mm
Material: aluminum
 - The built-in servo motor brake is only for keeping the object in a stopped state.
 - If the operating temperature is over 40°C, refer to the power derating curves of B3 motors on page 37.

5. Please follow the max. tolerant loading of the motor shaft end listed below during operation

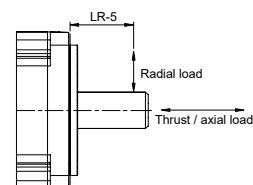

Electrical Specifications - 200 V

Motor with Frame Size of 100 / 130 Medium Inertia Motor ECM-B3M Series

	ECM-B3M-C [2] 1020	ECM-B3M-E [2] 1310	ECM-B3M-E [2] 1315	ECM-B3M-E [2] 1320
Rated Power (kW)	2	1	1.5	2
Rated Torque (N-m)*2	6.37	4.77	7.16	9.55
Maximum Torque (N-m)	19.1	14.3	21.48	28.65
Rated Speed (rpm)	3000		2000	
Maximum Speed (rpm)	6000		3000	
Rated Current (Arms)	9.96	5.96	8.17	10.59
Max. Instantaneous Current (Arms)	30.7	19.9	26.82	34.2
Rated Power Rate (kW/s)	86.7	29.21	45.69	62.25
Rated Power Rate (kW/s) with brake	82	28.66	45.09	61.62
Rotor Inertia (×10 ⁻⁴ kg.m ²)	4.68	7.79	11.22	14.65
Rotor Inertia (×10 ⁻⁴ kg.m ²) with brake	4.95	7.94	11.37	14.8
Mechanical Time Constant (ms)	0.523	1.46	1.1	1.03
Mechanical Time Constant (ms) with brake	0.554	1.49	1.12	1.04
Torque Constant -KT (N-m/A)	0.64	0.8	0.88	0.9
Voltage Constant -KE (mV/(rpm))	23.7	29.3	31.69	32.7
Armature Resistance (Ohm)	0.162	0.419	0.26	0.198
Armature Inductance (mH)	1.23	4	2.81	2.18
Electrical Time Constant (ms)	7.59	9.55	10.81	11.01
Weight – without brake (kg)	5.09	4.9	6	7
Weight – with brake (kg)	6.51	6.3	7.4	8.5
Max. Radial Loadin (N) ⁵	490	490	686	980
Max. Axial Loading (N) ⁵	196	98	343	392
Brake working voltage	24 V _{DC} ± 10%			
Brake Power Consumption (at 20°C)[W]	17.6	21.5	21.5	21.5
Brake Holding Torqu [Nt-m (min)] ⁺³	9.5	10	10	10
Brake Release Time [ms (Max)]	50	50	50	50
Brake Pull-In Time [ms (Max)]	110	110	110	110
Derating (%) (with oil seal)	5	5	5	5
Torque Feature (T-N Curve)				
Insulation Class	Class A (UL), Class B (CE)			
Insulation Resistance	> 100 MΩ, DC 500V			
Insulation Strength	1.8 kVAc, 1 sec			
Vibration Level (μm)	V15			
Operating Temperature	-20°C - 60°C*4			
Storage Temperature	-20°C - 80°C*4			
Storage & Operation Humidity	20 - 90%RH (non-condensing)			
Vibration Capacity	2.5 G			
IP Rating	IP67 (when using waterproof connections and when an oil seal is fitted to the rotating shaft (for an oil seal model))			
Certifications				

- Notes:
- In the servo motor model name, [1] represents the motor inertia and [2] represents the encoder type.
 - The rated torque is the continuous permissible torque between 0 to 40°C operating temperature which is suitable for the servo motor mounted with the following heat sink dimensions.
 F100: 300 mm x 300 mm x 12 mm
 F130: 400 mm x 400 mm x 20 mm
 Material: aluminum
 - The built-in servo motor brake is only for keeping the object in a stopped state.
 Do not use it for deceleration or as a dynamic brake
 - If the operating temperature is over 40°C, refer to the power derating curves of B3 motors on page 37.
 - Please follow the max. tolerant loading of the motor shaft end listed below during operation

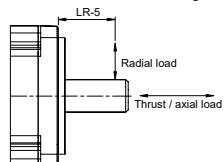

ECM-B3 Series Servo Motor Specifications

Electrical Specifications - 200 V

Motor with Frame Size of 130 High Inertia Motor ECM-B3H Series

	ECM-B3H-F 2 1308	ECM-B3H-F 2 1313	ECM-B3H-F 2 1318
Rated Power (kW)	0.85	1.3	1.8
Rated Torque (N-m) ^{*2}	5.39	8.34	11.5
Maximum Torque (N-m)	16.17	25.02	34.5
Rated Speed (rpm)	1500		
Maximum Speed (rpm)	4000		
Rated Current (Arms)	6.65	7.7	11.5
Max. Instantaneous Current (Arms)	20	23.9	36.1
Rated Power Rate (kW/s)	23.4	38.6	58.5
Rated Power Rate (kW/s) with brake	23	38.3	58
Rotor Inertia ($\times 10^{-4}$ kg.m ²)	12.44	18	22.6
Rotor Inertia ($\times 10^{-4}$ kg.m ²) with brake	12.62	18.14	22.8
Mechanical Time Constant (ms)	2.48	1.98	1.7
Mechanical Time Constant (ms) with brake	2.52	1.99	1.71
Torque Constant -KT (N-m/A)	0.811	1.08	1
Voltage Constant -KE (mV/(rpm))	29.8	38.8	35.3
Armature Resistance (Ohm)	0.46	0.44	0.253
Armature Inductance (mH)	2.5	2.76	1.7
Electrical Time Constant (ms)	5.43	6.27	6.72
Weight - without brake (kg)	6	7	8
Weight - with brake (kg)	7.5	8.5	9.5
Max. Radial Loadin (N) ^{*5}	490	686	980
Max. Axial Loading (N) ^{*5}	98	343	392
Brake working voltage	24 V _{DC} \pm 10%		
Brake Power Consumption (at 20°C)[W]	17.6	17.6	17.6
Brake Holding Torqu [Nt-m (min)] ^{*3}	9.5	9.5	9.5
Brake Release Time [ms (Max)]	60	60	60
Brake Pull-In Time [ms (Max)]	120	120	120
Derating (%) (with oil seal)	5	5	5
Torque Feature (T-N Curve)			
Insulation Class	Class F (UL), Class F (CE)		
Insulation Resistance	> 100 MΩ, DC 500 V		
Insulation Strength	1.8k Vac, 1 sec		
Vibration Level (μm)	V15		
Operating Temperature	-20°C - 60°C*4		
Storage Temperature	-20°C - 80°C		
Storage & Operation Humidity	20 - 90% RH (non-condensing)		
Vibration Capacity	2.5 G		
IP Rating	IP67 (when using waterproof connections and when an oil seal is fitted to the rotating shaft (for an oil seal model))		
Certifications			

Notes:

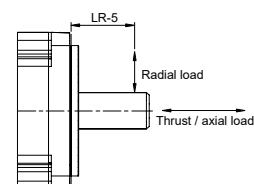

- In the servo motor model name, 2 represents the encoder type.
- The rated torque is the continuous permissible torque between 0 to 40°C operating temperature which is suitable for the servo motor mounted with the following heat sink dimensions.
F130: 400 mm x 400 mm x 20 mm
Material: aluminum
- The built-in servo motor brake is only for keeping the object in a stopped state.
- If the operating temperature is over 40°C, refer to the power derating curves of B3 motors on page 37.

- Please follow the max. tolerant loading of the motor shaft end listed below during operation

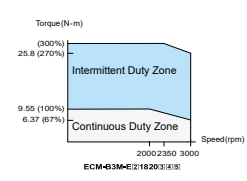
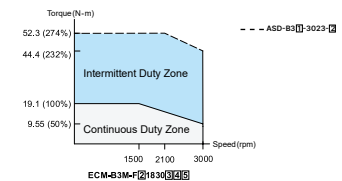

Electrical Specifications - 200 V

Motor with Frame Size of 180 Medium Inertia Motor ECM-B3M Series

	ECM-B3M-E 1820	ECM-B3M-F 1830
Rated Power (kW)	2	3
Rated Torque (N-m) ^{*2}	9.55	19.1
Maximum Torque (N-m)	28.65	57.29
Rated Speed (rpm)	2000	1500
Maximum Speed (rpm)	3000	3000
Rated Current (Arms)	11.43	18.21
Max. Instantaneous Current (Arms)	36.21	58.9
Rated Power Rate (kW/s)	31.33	68.02
Rated Power Rate (kW/s) with brake	30.02	66.45
Rotor Inertia (×10 ⁻⁴ kg.m ²)	29.11	53.63
Rotor Inertia (×10 ⁻⁴ kg.m ²) with brake	30.38	54.9
Mechanical Time Constant (ms)	1.83	1.21
Mechanical Time Constant (ms) with brake	1.91	1.24
Torque Constant -KT (N-m/A)	0.836	1.05
Voltage Constant -KE (mV/(rpm))	31.6	37.9
Armature Resistance (Ohm)	0.159	0.086
Armature Inductance (mH)	2.34	1.52
Electrical Time Constant (ms)	14.72	17.67
Weight – without brake (kg)	10	13.9
Weight – with brake (kg)	13.7	17.6
Max. Radial Loadin (N) ^{*5}	1470	1470
Max. Axial Loading (N) ^{*5}	490	490
Brake working voltage	24 V _{DC} ± 10%	
Brake Power Consumption (at 20°C)[W]	25	25
Brake Holding Torqu [Nt-m (min)] ^{*3}	31	31
Brake Release Time [ms (Max)]	30	30
Brake Pull-In Time [ms (Max)]	120	120
Derating (%) (with oil seal)	5	5
Torque Feature (T-N Curve)		
Insulation Class	Insulation Class: Class A(UL) , Class B(CE)	
Insulation Resistance	> 100 MΩ, DC 500 V	
Insulation Strength	1.8k Vac, 1 sec	
Vibration Level (μm)	V15	
Operating Temperature	-20°C - 60°C*4	
Storage Temperature	-20°C - 80°C	
Storage & Operation Humidity	20 - 90% RH (non-condensing)	
Vibration Capacity	2.5 G	
IP Rating	IP67 (when using waterproof connections and when an oil seal is fitted to the rotating shaft (for an oil seal model))	
Certifications		

Notes:

- In the servo motor model name, 2 represents the encoder type.
- The rated torque is the continuous permissible torque between 0 to 40°C operating temperature which is suitable for the servo motor mounted with the following heat sink dimensions.
F180: 550 mm x 550 mm x 30 mm
Material: aluminum
- The built-in servo motor brake is only for keeping the object in a stopped state.
- If the operating temperature is over 40°C, refer to the power derating curves of B3 motors on page 37.

5. Please follow the max. tolerant loading of the motor shaft end listed below during operation

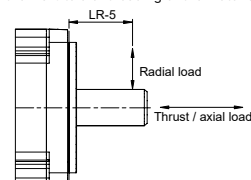

ECM-B3 Series Servo Motor Specifications

Electrical Specifications - 400 V

Motor with Frame Size of 80 mm or below / Frame Size of 100 Medium Inertia Motor ECM-B3M Series

	ECM-B3M-J 0604	ECM-B3M-J 0807	ECM-B3M-J 1010	ECM-B3M-J 1015
Rated Power (kW)	0.4	0.75	1	1.5
Rated Torque (N-m) ²	1.27	2.4	3.18	4.77
Maximum Torque (N-m)	4.45	8.4	9.54	14.3
Rated Speed (rpm)	3000			
Maximum Speed (rpm)	6000			
Rated Current (Arms)	1.35	2.15	3.03	3.73
Max. Instantaneous Current (Arms)	5.2	7.9	9.21	11.4
Rated Power Rate (kW/s)	63.5	53.83	36.4	61.7
Rated Power Rate (kW/s) with brake	61.09	50.97	33	57.3
Rotor Inertia ($\times 10^{-4}$ kg.m ²)	0.254	1.07	2.78	3.69
Rotor Inertia ($\times 10^{-4}$ kg.m ²) with brake	0.264	1.13	3.06	3.97
Mechanical Time Constant (ms)	0.53	0.55	0.737	0.546
Mechanical Time Constant (ms) with brake	0.55	0.58	0.811	0.587
Torque Constant -KT (N-m/A)	0.94	1.12	1.05	1.28
Voltage Constant -KE (mV/(rpm))	34.66	40.34	39.5	47.8
Armature Resistance (Ohm)	6.47	2.2	1.05	0.864
Armature Inductance (mH)	20.6	11.2	7.5	6.63
Electrical Time Constant (ms)	3.18	5.09	7.14	7.67
Weight – without brake (kg)	1.2	2.34	3.56	4.37
Weight – with brake (kg)	1.6	3.15	4.88	5.68
Max. Radial Loadin (N) ⁵	245	392	490	490
Max. Axial Loading (N) ⁵	74	147	196	196
Brake working voltage	24 V _{DC} \pm 10%			
Brake Power Consumption (at 20°C)[W]	7.6	8	17.6	17.6
Brake Holding Torqu [Nt-m (min)] ³	1.3	2.5	9.5	9.5
Brake Release Time [ms (Max)]	20	20	50	50
Brake Pull-In Time [ms (Max)]	50	60	110	110
Derating (%) (with oil seal)	5	5	5	5

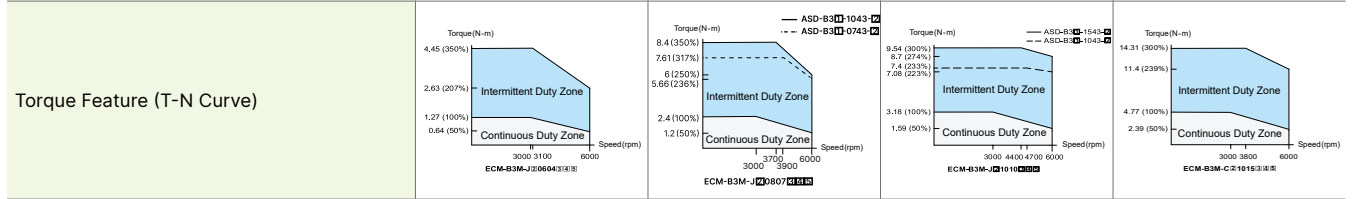

Insulation Class	Class A (UL), Class B (CE)
Insulation Resistance	> 100 M Ω , DC 500 V
Insulation Strength	2.3k Vac, 1 sec
Vibration Level (μ m)	V15
Operating Temperature	-20°C - 60°C*4
Storage Temperature	-20°C - 80°C
Storage & Operation Humidity	20 - 90% RH (non-condensing)
Vibration Capacity	2.5 G
IP Rating	IP67 (when using waterproof connections and when an oil seal is fitted to the rotating shaft (for an oil seal model))
Certifications	

- Notes:
- In the servo motor model name, 2 represents the encoder type.
 - The rated torque is the continuous permissible torque between 0 to 40°C operating temperature which is suitable for the servo motor mounted with the following heat sink dimensions.
F60, F80: 250 mm x 250 mm x 6 mm
F100: 300 mm x 300 mm x 12 mm
Material: aluminum
 - The built-in servo motor brake is only for keeping the object in a stopped state.
 - If the operating temperature is over 40°C, refer to the power derating curves of B3 motors on page 37.

- Please follow the max. tolerant loading of the motor shaft end listed below during operation

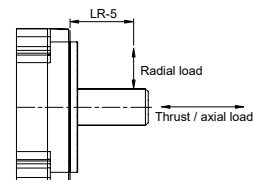

Electrical Specifications - 400 V

Motor with Frame Size of 100 / 130 Medium Inertia Motor ECM-B3M Series

	ECM-B3M-J 1020	ECM-B3M-K 1310	ECM-B3M-K 1315	ECM-B3M-K 1320
Rated Power (kW)	2	1	1.5	2
Rated Torque (N-m) ^{*2}	6.37	4.77	7.16	9.55
Maximum Torque (N-m)	19.1	14.3	21.48	28.65
Rated Speed (rpm)	3000		2000	
Maximum Speed (rpm)	6000		3000	
Rated Current (Arms)	5	3	4.09	5.3
Max. Instantaneous Current (Arms)	15.3	9.95	13.37	17.1
Rated Power Rate (kW/s)	86.7	29.21	45.69	62.25
Rated Power Rate (kW/s) with brake	82	28.66	45.09	61.62
Rotor Inertia (×10 ⁻⁴ kg.m ²)	4.68	7.79	11.22	14.65
Rotor Inertia (×10 ⁻⁴ kg.m ²) with brake	4.95	7.94	11.37	14.8
Mechanical Time Constant (ms)	0.528	1.47	1.1	1.03
Mechanical Time Constant (ms) with brake	0.559	1.5	1.12	1.04
Torque Constant -KT (N-m/A)	1.27	1.59	1.75	1.8
Voltage Constant -KE (mV/(rpm))	47.2	58.6	63.38	65.4
Armature Resistance (Ohm)	0.646	1.68	1.04	0.792
Armature Inductance (mH)	4.89	16	11.2	8.72
Electrical Time Constant (ms)	7.57	9.52	10.8	11
Weight – without brake (kg)	5.09	4.9	6	7
Weight – with brake (kg)	6.505	6.3	7.4	8.5
Max. Radial Loadin (N) ^{*5}	490	490	686	980
Max. Axial Loading (N) ^{*5}	196	98	343	392
Brake working voltage	24 V _{DC} ± 10%			
Brake Power Consumption (at 20°C)[W]	17.6	21.5	21.5	21.5
Brake Holding Torqu [Nt-m (min)] ^{*3}	9.5	10	10	10
Brake Release Time [ms (Max)]	50	50	50	50
Brake Pull-In Time [ms (Max)]	110	110	110	110
Derating (%) (with oil seal)	5	5	5	5

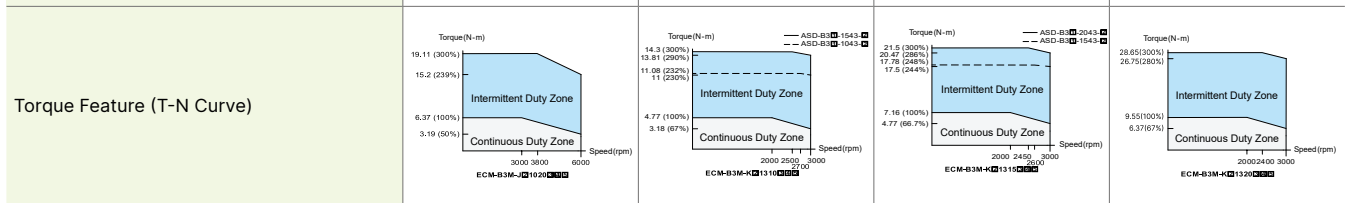

Insulation Class	Class A (UL), Class B (CE)
Insulation Resistance	> 100 MΩ, DC 500 V
Insulation Strength	2.3k Vac, 1 sec
Vibration Level (μm)	V15
Operating Temperature	-20°C - 60°C*4
Storage Temperature	-20°C - 80°C
Storage & Operation Humidity	20 - 90% RH (non-condensing)
Vibration Capacity	2.5 G
IP Rating	IP67 (when using waterproof connections and when an oil seal is fitted to the rotating shaft (for an oil seal model))
Certifications	

- Notes:
- In the servo motor model name, 2 represents the encoder type.
 - The rated torque is the continuous permissible torque between 0 to 40°C operating temperature which is suitable for the servo motor mounted with the following heat sink dimensions.
F100: 300 mm x 300 mm x 12 mm
F130: 400 mm x 400 mm x 20 mm
Material: aluminum
 - The built-in servo motor brake is only for keeping the object in a stopped state.
 - If the operating temperature is over 40°C, refer to the power derating curves of B3 motors on page 37.

5. Please follow the max. tolerant loading of the motor shaft end listed below during operation

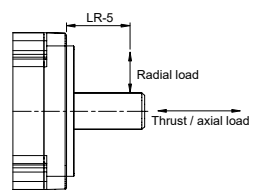

ECM-B3 Series Servo Motor Specifications

Electrical Specifications - 400 V

Motor with Frame Size of 180 Medium Inertia Motor ECM-B3M Series / Frame Size of 130 High Inertia Motor ECM-B3H Series

	ECM-B3H-L 2 1308	ECM-B3H-L 2 1313	ECM-B3H-L 2 1318	ECM-B3M-K 2 1820
Rated Power (kW)	0.85	1.3	1.8	2
Rated Torque (N-m) ^{*2}	5.39	8.34	11.5	9.55
Maximum Torque (N-m)	16.17	25.02	34.5	28.65
Rated Speed (rpm)		1500		2000
Maximum Speed (rpm)		4000		3000
Rated Current (Arms)	3.35	3.85	5.75	5.7
Max. Instantaneous Current (Arms)	10	12	18.1	18.1
Rated Power Rate (kW/s)	23.4	38.6	58.5	31.33
Rated Power Rate (kW/s) with brake	23	38.3	58	30.02
Rotor Inertia ($\times 10^{-4}$ kg.m ²)	12.44	18	22.6	29.11
Rotor Inertia ($\times 10^{-4}$ kg.m ²) with brake	12.62	18.14	22.8	30.38
Mechanical Time Constant (ms)	2.5	1.97	1.69	1.83
Mechanical Time Constant (ms) with brake	2.54	1.99	1.71	1.91
Torque Constant -KT (N-m/A)	1.61	2.17	2	1.68
Voltage Constant -KE (mV/(rpm))	59.5	77.6	70.7	63.2
Armature Resistance (Ohm)	1.84	1.76	1.01	0.636
Armature Inductance (mH)	10	11	6.8	9.36
Electrical Time Constant (ms)	5.43	6.25	6.73	14.72
Weight – without brake (kg)	6	7	8	10
Weight – with brake (kg)	7.5	8.5	9.5	13.7
Max. Radial Loadin (N) ^{*5}	490	686	980	1470
Max. Axial Loading (N) ^{*5}	98	343	392	490
Brake working voltage	24 V _{DC} \pm 10%			
Brake Power Consumption (at 20°C)[W]	24	24	24	31
Brake Holding Torqu [Nt-m (min)] ^{*3}	16	16	16	25
Brake Release Time [ms (Max)]	60	60	60	30
Brake Pull-In Time [ms (Max)]	120	120	120	120
Derating (%) (with oil seal)	5	5	5	5
Torque Feature (T-N Curve)				
Insulation Class	Class F (UL), Class F (CE)			Class A (UL), Class B (CE)
Insulation Resistance	> 100 M Ω , DC 500 V			
Insulation Strength	1.8k Vac, 1 sec			
Vibration Level (μ m)	V15			
Operating Temperature	-20°C - 60°C*4			
Storage Temperature	-20°C - 80°C			
Storage & Operation Humidity	20 - 90% RH (non-condensing)			
Vibration Capacity	2.5 G			
IP Rating	IP67 (when using waterproof connections and when an oil seal is fitted to the rotating shaft (for an oil seal model))			
Certifications				

Notes:

- In the servo motor model name, 2 represents the encoder type.
- The rated torque is the continuous permissible torque between 0 to 40°C operating temperature which is suitable for the servo motor mounted with the following heat sink dimensions.
 FT30: 400 mm x 400 mm x 20 mm
 F180: 550 mm x 550 mm x 30 mm
 Material: aluminum
- The built-in servo motor brake is only for keeping the object in a stopped state.
- If the operating temperature is over 40°C, refer to the power derating curves of B3 motors on page 37.

5. Please follow the max. tolerant loading of the motor shaft end listed below during operation

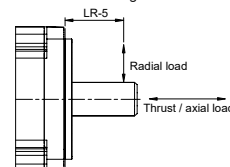

Electrical Specifications - 400 V

Motor with Frame Size of 180 Medium Inertia Motor ECM-B3M Series

	ECM-B3M-L 2 1830	ECM-B3M-L 2 1845	ECM-B3M-L 2 1855	ECM-B3M-L 2 1875
Rated Power (kW)	3	4.5	5.5	7.5
Rated Torque (N-m) ²	19.1	28.65	35.01	47.75
Maximum Torque (N-m)	57.29	71.6	105	119
Rated Speed (rpm)	1500		1500	
Maximum Speed (rpm)	3000		4000	
Rated Current (Arms)	9.1	13.3	15.3	22.1
Max. Instantaneous Current (Arms)	29.45	35.35	49.29	56.68
Rated Power Rate (kW/s)	68.02	121	124	169
Rated Power Rate (kW/s) with brake	66.45	119	122	167
Rotor Inertia (×10 ⁻⁴ kg.m ²)	53.63	67.73	98.88	134.95
Rotor Inertia (×10 ⁻⁴ kg.m ²) with brake	54.9	69.15	100.1	136.24
Mechanical Time Constant (ms)	1.21	1.07	1.01	1.01
Mechanical Time Constant (ms) with brake	1.24	1.09	1.02	1.02
Torque Constant -KT (N-m/A)	2.1	2.15	2.29	2.16
Voltage Constant -KE (mV/(rpm))	75.8	78.8	81.8	77.4
Armature Resistance (Ohm)	0.344	0.255	0.182	0.12
Armature Inductance (mH)	6.08	4.68	3.48	2.27
Electrical Time Constant (ms)	17.67	18.4	19.1	18.9
Weight – without brake (kg)	13.9	16.5	21.2	27.2
Weight – with brake (kg)	17.6	20.2	24.9	30.9
Max. Radial Loadin (N) ⁵	1470	1470	1764	1764
Max. Axial Loading (N) ⁵	490	490	588	588
Brake working voltage	24 V _{DC} ± 10%			
Brake Power Consumption (at 20°C)[W]	31	31	31	31
Brake Holding Torqu [Nt-m (min)] ³	25	55	55	55
Brake Release Time [ms (Max)]	30	50	50	50
Brake Pull-In Time [ms (Max)]	120	150	150	150
Derating (%) (with oil seal)	5	0	0	0
Torque Feature (T-N Curve)				
Insulation Class	Class A (UL), Class B (CE)		Class F (UL), Class F (CE)	
Insulation Resistance	> 100 M Ω, DC 500 V			
Insulation Strength	2.3k Vac, 1 sec			
Vibration Level (μm)	V15			
Operating Temperature	-20°C - 60°C*4			
Storage Temperature	-20°C - 80°C			
Storage & Operation Humidity	20 - 90% RH (non-condensing)			
Vibration Capacity	2.5 G			
IP Rating	IP67 (when using waterproof connections and when an oil seal is fitted to the rotating shaft (for an oil seal model))			
Certifications				

- Notes:
- In the servo motor model name, 2 represents the encoder type.
 - The rated torque is the continuous permissible torque between 0 to 40°C operating temperature which is suitable for the servo motor mounted with the following heat sink dimensions.
F180: 550 mm x 550 mm x 30 mm
Material: aluminum
 - The built-in servo motor brake is only for keeping the object in a stopped state.
 - If the operating temperature is over 40°C, refer to the power derating curves of B3 motors on page 37.
 - Please follow the max. tolerant loading of the motor shaft end listed below during operation

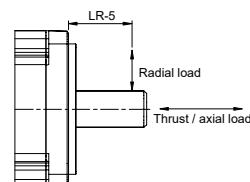

ECM-B3 Series Servo Motor Specifications

Power Derating Curves

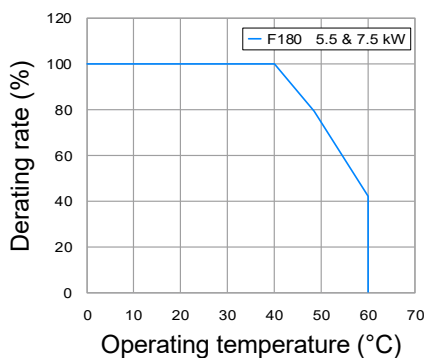
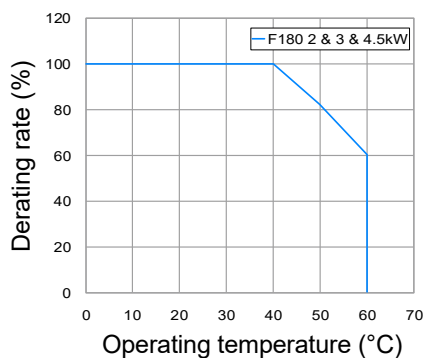
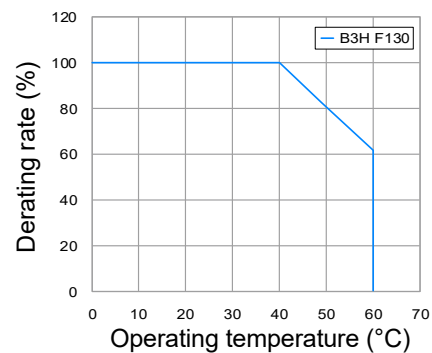
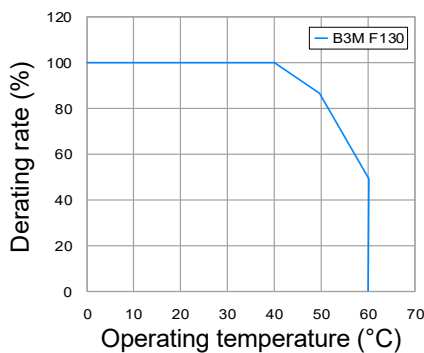
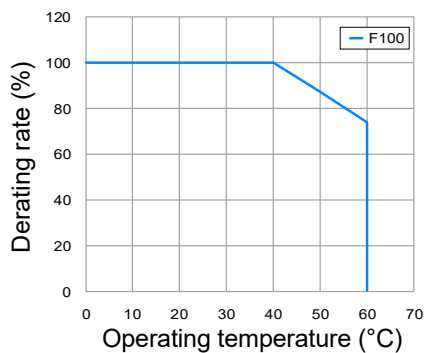
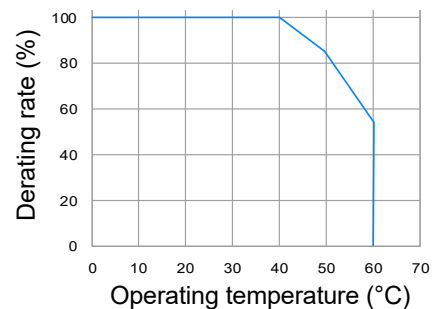
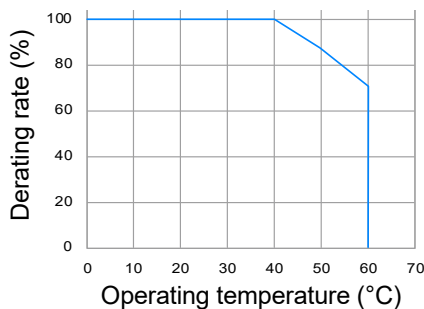
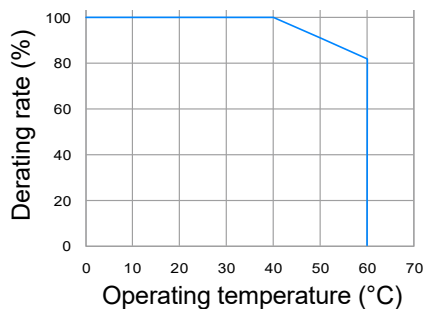

Note: Applicable for 220V and 400V models

220V Dimensions of Motors with Frame Size of 80 mm or Below

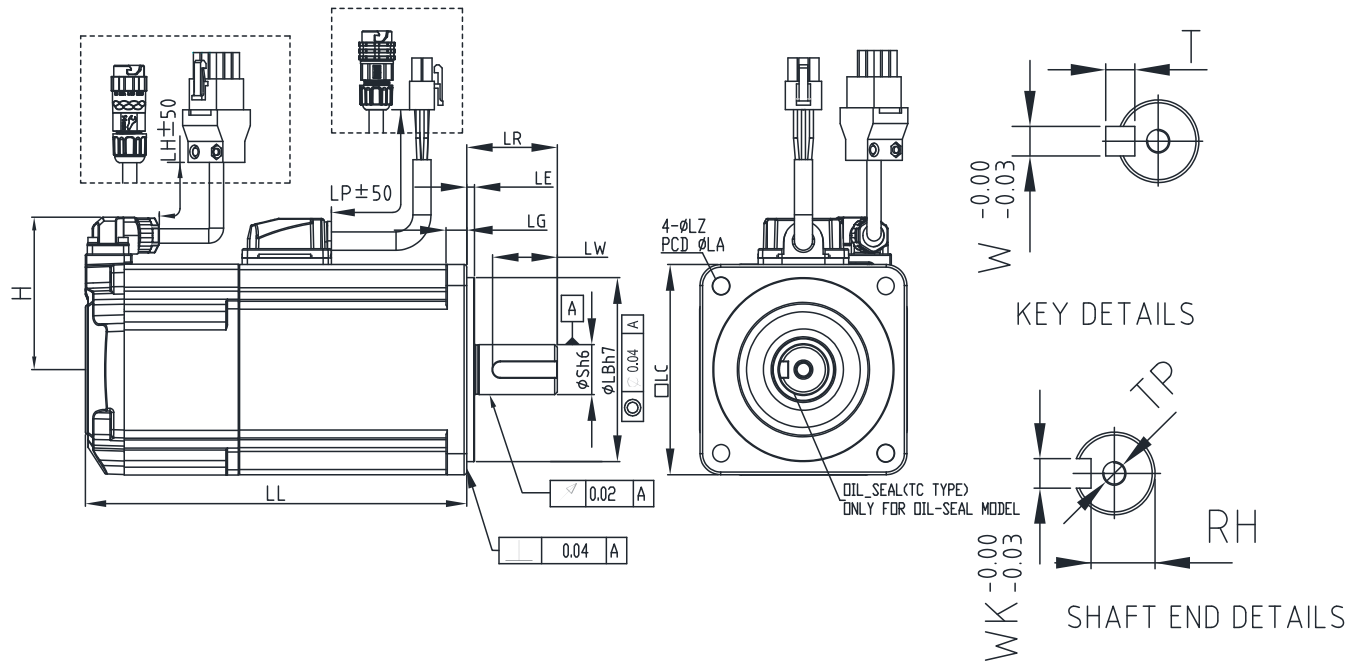

Model	B3L-C ② 0401	B3M-C ② 0602	B3M-C ② 0604	B3M-C ② 0804	B3M-C ② 0807	B3M-C ② 0810
LC	40	60	60	80	80	80
LZ	4.5	5.5	5.5	6.6	6.6	6.6
LA	46	70	70	90	90	90
S	8 ^(+0/-0.009)	14 ^(+0/-0.011)	14 ^(+0/-0.011)	14 ^(+0/-0.011)	19 ^(+0/-0.013)	19 ^(+0/-0.013)
LB	30 ^(+0/-0.021)	50 ^(+0/-0.025)	50 ^(+0/-0.025)	70 ^(+0/-0.030)	70 ^(+0/-0.030)	70 ^(+0/-0.030)
LL (w/o brake)	77.6	72.5	91	86.7	105.2	118.7
LL (with brake)	111.7	109.4	127.9	126.3	144.8	158.3
LH	300	300	300	300	300	300
LP	300	300	300	300	300	300
H	40	48.5	48.5	58.5	58.5	58.5
LR	25	30	30	30	35	35
LE	2.5	3	3	3	3	3
LG	5	7.5	7.5	8	8	8
LW	16	20	20	20	25	25
RH	6.2	11	11	11	15.5	15.5
WK	3	5	5	5	6	6
W	3	5	5	5	6	6
T	3	5	5	5	6	6
TP	M3 Depth 8	M4 Depth 15	M4 Depth 15	M4 Depth 15	M6 Depth 20	M6 Depth 20

Notes:
1. In the servo motor model name, ② represents the encoder type

ECM-B3 Series Servo Motor Specifications²

220V Dimensions of Motors with Frame Size of 100 mm

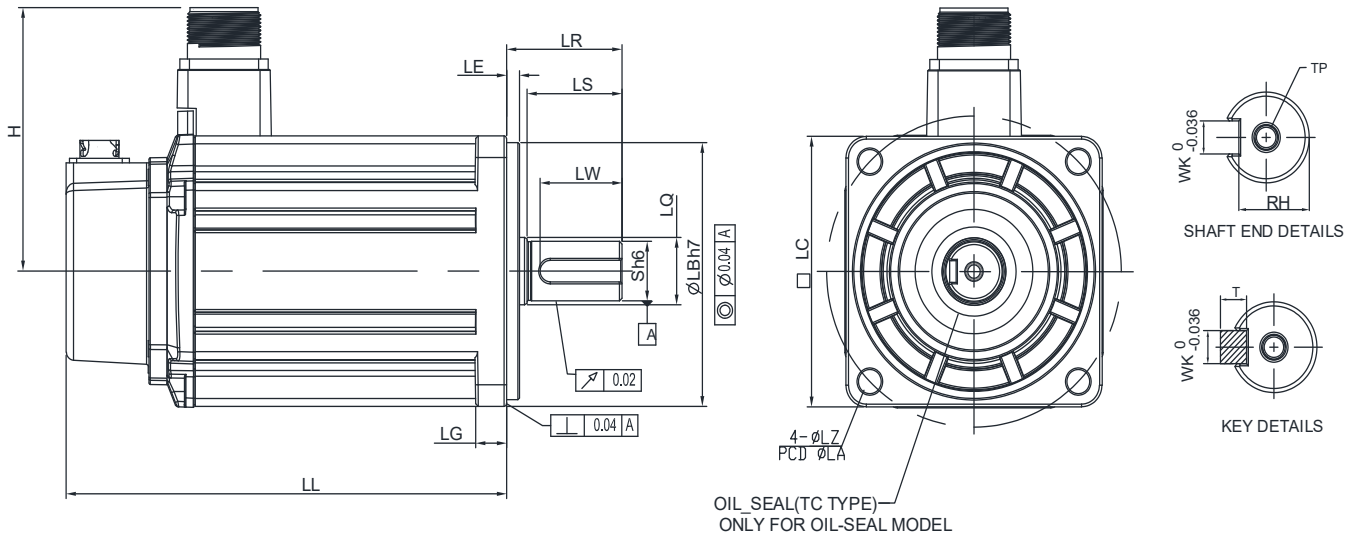

Model	B3M-C ② 1010	B3M-C ② 1015	B3M-C ② 1020
LC	100	100	100
LZ	9	9	9
LA	115	115	115
S	22 ^(+0/-0.013)	22 ^(+0/-0.013)	22 ^(+0/-0.013)
LB	95 ^(+0/-0.03)	95 ^(+0/-0.03)	95 ^(+0/-0.03)
LL (w/o brake)	141.8	156.8	171.8
LL (with brake)	179.9	194.9	209.9
H	97.4	97.4	97.4
LS	37	37	37
LR	45	45	45
LQ	25	25	25
LE	5	5	5
LG	12	12	12
LW	32	32	32
RH	18	18	18
WK	8	8	8
W	8	8	8
T	7	7	7
TP	M6 Depth12	M6 Depth12	M6 Depth12

Notes:
1. In the servo motor model name, ② represents the encoder type

220V Dimensions of Motors with Frame Size of 130 mm

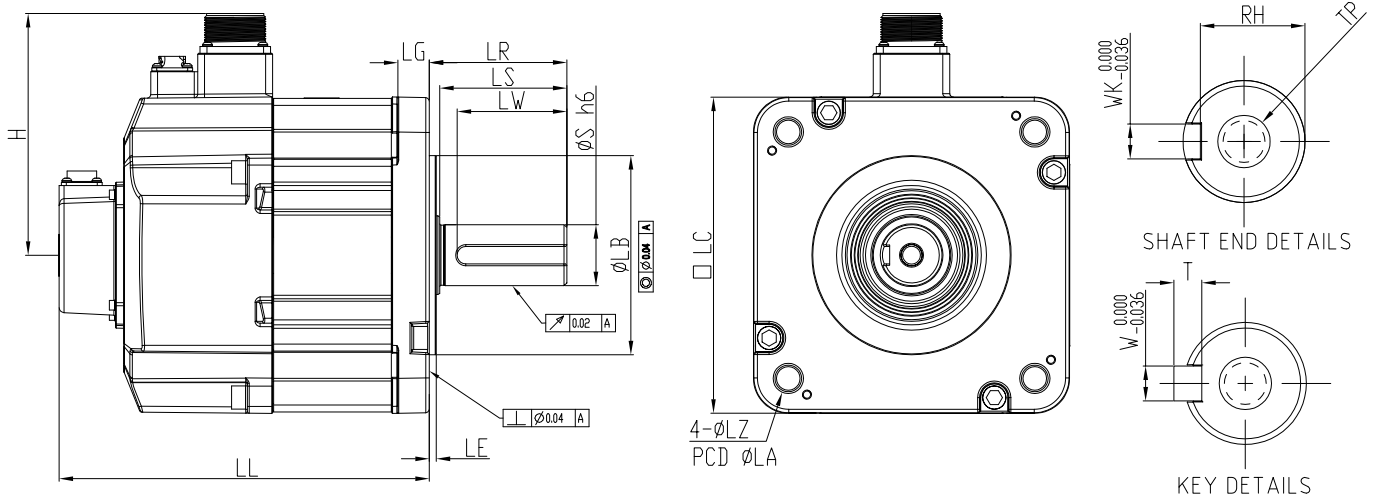

Model	B3M-E ② 1310	B3M-E ② 1315	B3M-E ② 1320	B3H-F ② 1308	B3H-F ② 1313	B3H-F ② 1318
LC	130	130	130	130	130	130
LZ	9	9	9	9	9	9
LA	145	145	145	145	145	145
S	22(⁺⁰ / _{-0.013})	22(⁺⁰ / _{-0.013})	22(⁺⁰ / _{-0.013})	22(⁺⁰ / _{-0.013})	22(⁺⁰ / _{-0.013})	22(⁺⁰ / _{-0.013})
LB	110(⁺⁰ / _{-0.035})	110(⁺⁰ / _{-0.035})	110(⁺⁰ / _{-0.035})	110(⁺⁰ / _{-0.035})	110(⁺⁰ / _{-0.035})	110(⁺⁰ / _{-0.035})
LL (w/o brake)	127.9	139.9	151.9	127.9	139.9	151.9
LL (with brake)	168.5	180.5	192.5	168.5	180.5	192.5
H	115	115	115	115	115	115
LS	47	47	47	47	47	47
LR	55	55	55	55	55	55
LQ	28	28	28	28	28	28
LE	6	6	6	6	6	6
LG	12.5	12.5	12.5	12.5	12.5	12.5
LW	36	36	36	36	36	36
RH	18	18	18	18	18	18
WK	8	8	8	8	8	8
W	8	8	8	8	8	8
T	7	7	7	7	7	7
TP	M6 Depth12	M6 Depth12	M6 Depth12	M6 Depth12	M6 Depth12	M6 Depth12

Notes:
1. In the servo motor model name, ② represents the encoder type

ECM-B3 Series Servo Motor Specifications²

220V Dimensions of Motors with Frame Size of 180 mm

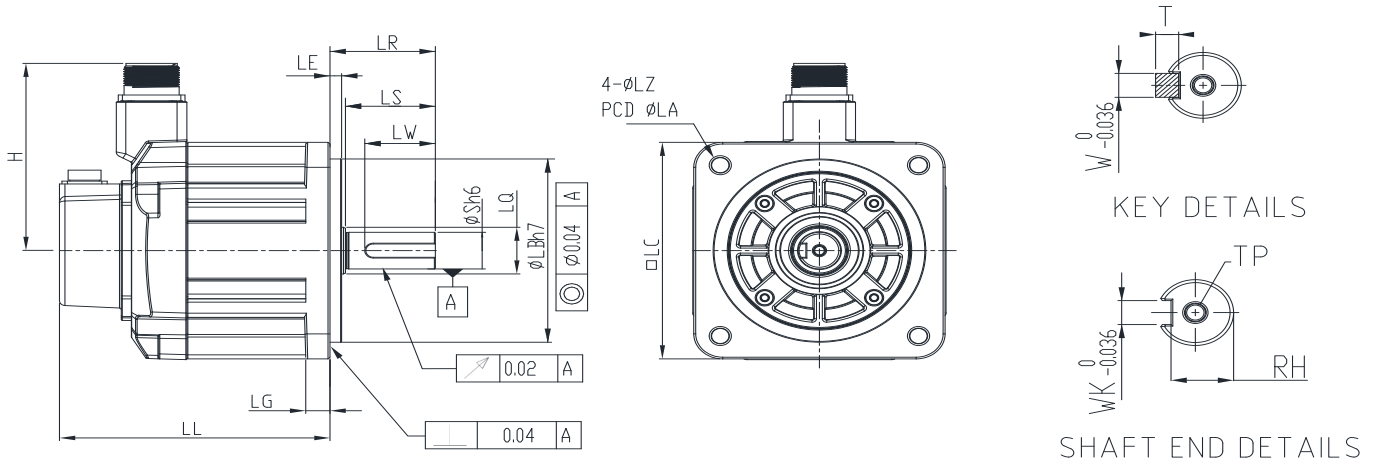

Model	B3M-E ② 1820	B3M-F ② 1830
LC	180	180
LZ	13.5	13.5
LA	200	200
S	35 ^(+0/-0.016)	35 ^(+0/-0.016)
LB	114.3 ^(+0/-0.035)	114.3 ^(+0/-0.035)
LL (w/o brake)	137.5	160.5
LL (with brake)	189.5	212.5
H	139	139
LS	73	73
LR	79	79
LQ	45	45
LE	4	4
LG	18	18
LW	63	63
RH	30	30
WK	10	10
W	10	10
T	8	8
TP	M12 Depth25	M12 Depth25

Notes:
1. In the servo motor model name, ② represents the encoder type

400V Dimensions of Motors with Frame Size of 80 mm or Below

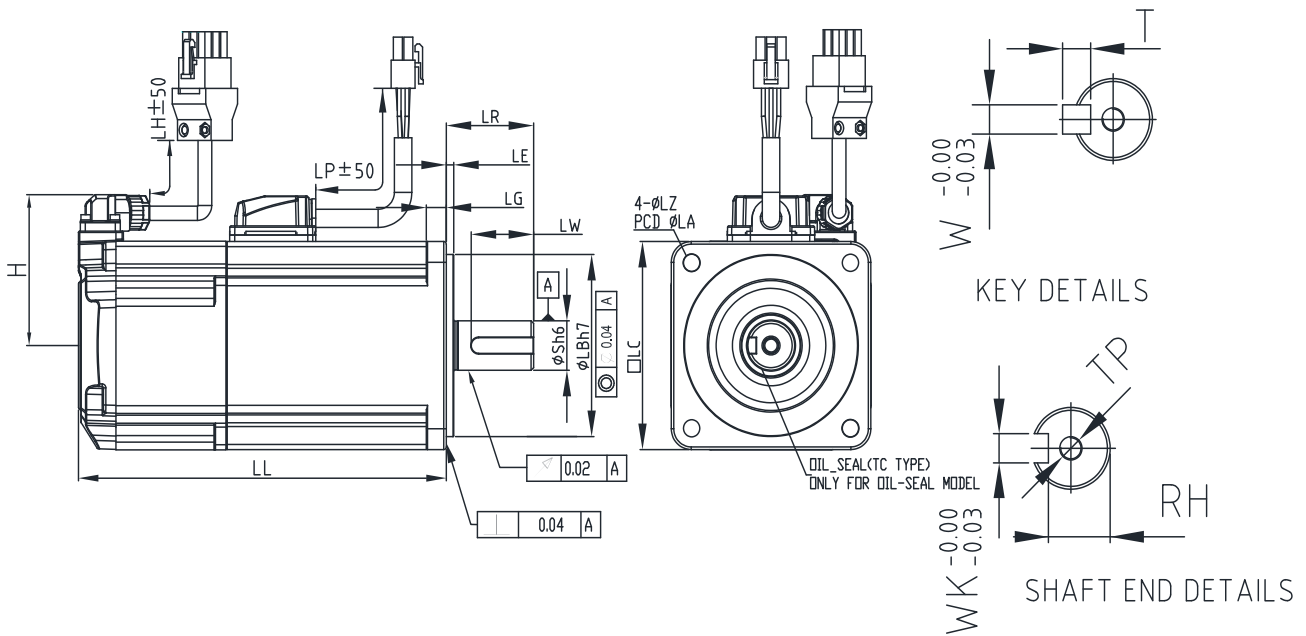

Model	B3M-J ② 0604	B3M-J ② 0807
LC	60	80
LZ	5.5	6.6
LA	70	90
S	14($\begin{smallmatrix} +0 \\ -0.011 \end{smallmatrix}$)	19($\begin{smallmatrix} +0 \\ -0.013 \end{smallmatrix}$)
LB	50($\begin{smallmatrix} +0.000 \\ -0.055 \end{smallmatrix}$)	70($\begin{smallmatrix} +0.000 \\ -0.030 \end{smallmatrix}$)
LL (w/o brake)	91	105.2
LL (with brake)	127.9	144.8
LH	300	300
LP	300	300
H	48.5	58.5
LR	30	35
LE	3	3
LG	7.5	8
LW	20	25
RH	11	15.5
WK	5	6
W	5	6
T	5	6
TP	M4 Depth15	M6 Depth20

Notes:
 1. In the servo motor model name, ② represents the encoder type

ECM-B3 Series Servo Motor Specifications

400V Dimensions of Motors with Frame Size of 100 mm

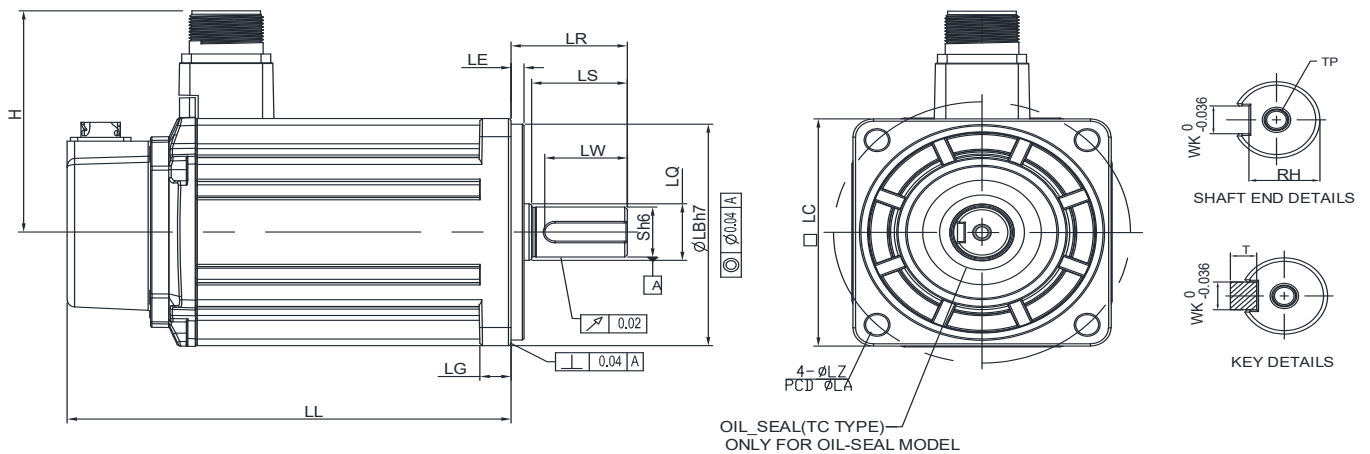

Model	B3M-J ② 1010	B3M-J ② 1015	B3M-J ② 1020
LC	100	100	100
LZ	9	9	9
LA	115	115	115
S	22(⁺⁰ / _{-0.013})	22(⁺⁰ / _{-0.013})	22(⁺⁰ / _{-0.013})
LB	95(⁺⁰ / _{-0.03})	95(⁺⁰ / _{-0.03})	95(⁺⁰ / _{-0.03})
LL (w/o brake)	141.8	156.8	171.8
LL (with brake)	179.9	194.9	209.9
H	97.4	97.4	97.4
LS	37	37	37
LR	45	45	45
LQ	25	25	25
LE	5	5	5
LG	12	12	12
LW	32	32	32
RH	18	18	18
WK	8	8	8
W	8	8	8
T	7	7	7
TP	M6 Depth12	M6 Depth12	M6 Depth12

Notes:
1. In the servo motor model name, ② represents the encoder type

400V Dimensions of Motors with Frame Size of 130 mm

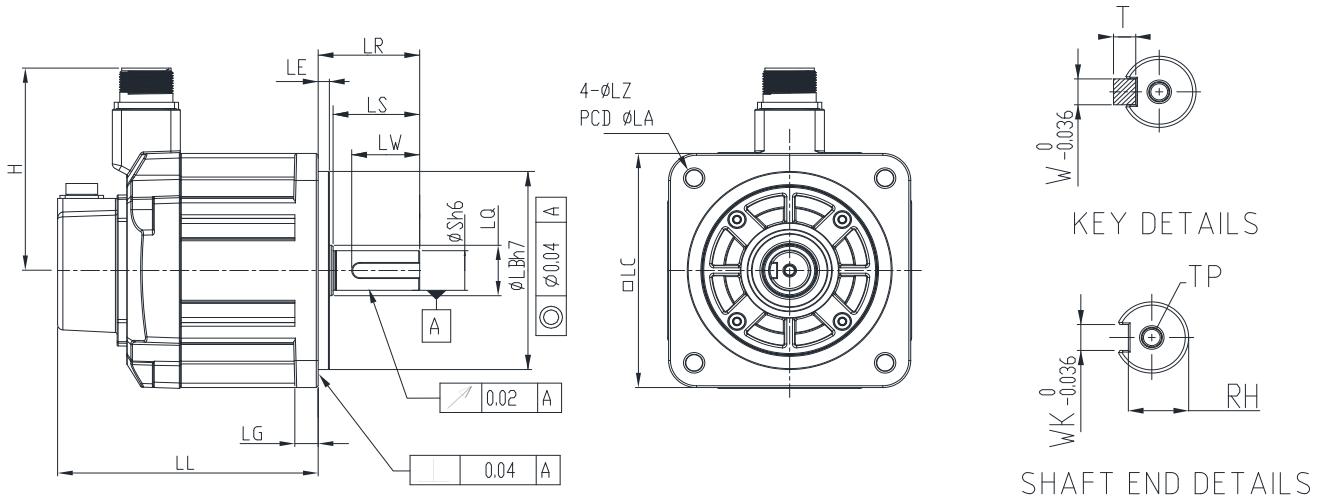

Model	B3M-K ② 1310	B3M-K ② 1315	B3M-K ② 1320	B3H-L ② 1308	B3H-L ② 1313	B3H-L ② 1318
LC	130	130	130	130	130	130
LZ	9	9	9	9	9	9
LA	145	145	145	145	145	145
S	22($^{+0}_{-0.013}$)	22($^{+0}_{-0.013}$)	22($^{+0}_{-0.013}$)	22($^{+0}_{-0.013}$)	22($^{+0}_{-0.013}$)	22($^{+0}_{-0.013}$)
LB	110($^{+0}_{-0.035}$)	110($^{+0}_{-0.035}$)	110($^{+0}_{-0.035}$)	110($^{+0}_{-0.035}$)	110($^{+0}_{-0.035}$)	110($^{+0}_{-0.035}$)
LL (w/o brake)	127.9	139.9	151.9	127.9	139.9	151.9
LL (with brake)	168.5	180.5	192.5	168.5	180.5	192.5
H	115	115	115	115	115	115
LS	47	47	47	47	47	47
LR	55	55	55	55	55	55
LQ	28	28	28	28	28	28
LE	6	6	6	6	6	6
LG	12.5	12.5	12.5	12.5	12.5	12.5
LW	36	36	36	36	36	36
RH	18	18	18	18	18	18
WK	8	8	8	8	8	8
W	8	8	8	8	8	8
T	7	7	7	7	7	7
TP	M6 Depth12	M6 Depth12	M6 Depth12	M6 Depth12	M6 Depth12	M6 Depth12

Notes:
1. In the servo motor model name, ② represents the encoder type

ECM-B3 Series Servo Motor Specifications

400V Dimensions of Motors with Frame Size of 180 mm

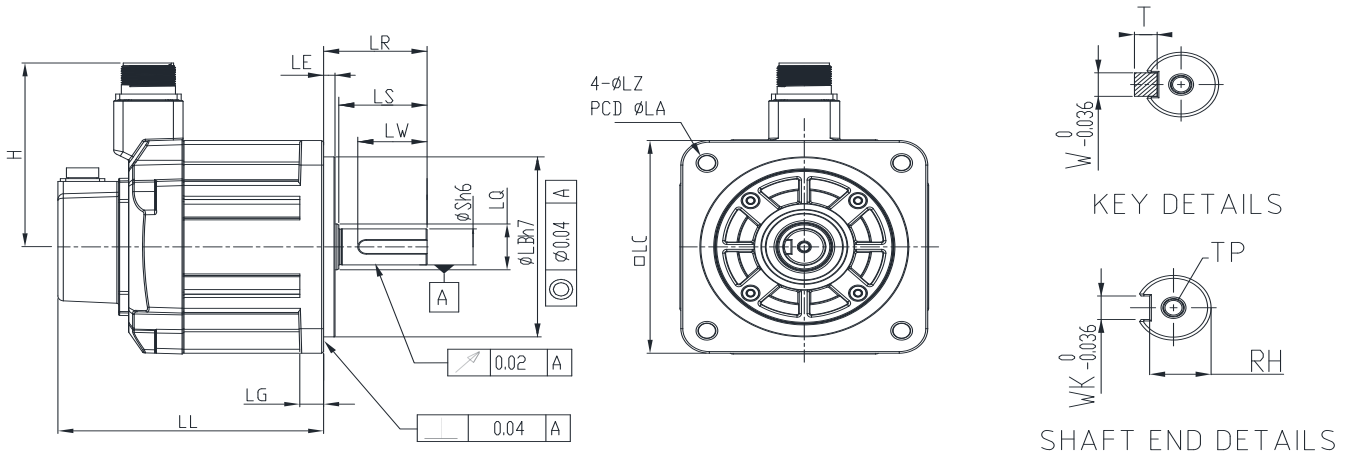

Model	B3M-K ② 1820	B3M-L ② 1830	B3M-L ② 1845	B3M-L ② 1855	B3M-L ② 1875
LC	180	180	180	180	180
LZ	13.5	13.5	13.5	13.5	13.5
LA	200	200	200	200	200
S	35 ^(+0/-0.016)	35 ^(+0/-0.016)	35 ^(+0/-0.016)	42 ^(+0/-0.016)	42 ^(+0/-0.016)
LB	114.3 ^(+0/-0.035)	114.3 ^(+0/-0.035)	114.3 ^(+0/-0.035)	114.3 ^(+0/-0.035)	114.3 ^(+0/-0.035)
LL (w/o brake)	137.5	160.5	174	218	260.1
LL (with brake)	189.5	212.5	226	265	307.1
H	139	139	139	144.5	144.5
LS	73	73	73	108.5	108.5
LR	79	79	79	113	113
LQ	45	45	45	45	45
LE	4	4	4	4	4
LG	18	18	18	18	18
LW	63	63	63	90	90
RH	30	30	30	37	37
WK	10	10	10	12	12
W	10	10	10	12	12
T	8	8	8	8	8
TP	M12 Depth25	M12 Depth25	M12 Depth25	M16 Depth32	M16 Depth32

Notes:
1. In the servo motor model name, ② represents the encoder type

ECM-A3 Series Servo Motor Specifications

Electrical Specifications

Low Inertia Motor ECM-A3L Series

	ECM-A3L-C \square 2040F ^{*1}	ECM-A3L-C \square 20401 ^{*1}	ECM-A3L-C \square 20602 ^{*1}	ECM-A3L-C \square 20604 ^{*1}
Rated Power (kW)	0.05	0.1	0.2	0.4
Rated Torque (N-m) ^{*2}	0.159	0.32	0.64	1.27
Maximum Torque (N-m)	0.557	1.12	2.24	4.45
Rated Speed (rpm)	3000			
Maximum Speed (rpm)	6000			
Rated Current (Arms)	0.66	0.9	1.45	2.65
Max. Instantaneous Current (Arms)	2.82	3.88	6.2	10.1
Rated Power Rate (kW/s) ^{*3}	11 (9.9)	25.6 (24)	45.5 (34.1)	107.5 (89.6)
Rotor Inertia ($\times 10^{-4}$ kg.m ²) ^{*3}	0.0229 (0.0255)	0.04 (0.0426)	0.09 (0.12)	0.15 (0.18)
Mechanical Time Constant (ms) ^{*3}	1.28 (1.44)	0.838 (0.892)	0.64 (0.85)	0.41 (0.5)
Torque Constant -KT (N-m/A)	0.241	0.356	0.441	0.479
Voltage Constant -KE (mV/(rpm))	9.28	13.3	16.4	18
Armature Resistance (Ohm)	12.1	9.47	4.9	2.27
Armature Inductance (mH)	18.6	16.2	18.52	10.27
Electrical Time Constant (ms)	1.54	1.71	3.78	4.52
Brake Holding Torque [Nt-m (min)] ^{*4}	0.32	0.32	1.3	1.3
Brake Power Consumption (at 20°C) [W]	6.1	6.1	7.2	7.2
Brake Release Time [ms (Max.)]	20	20	20	20
Brake Pull-In Time [ms (Max.)]	35	35	50	50
Max. Radial Loading (N) ^{*5}	78	78	245	245
Max. Axial Loading (N) ^{*5}	54	54	74	74
Weight (kg) ^{*3}	0.38 (0.68)	0.5 (0.8)	1.1 (1.6)	1.4 (1.9)
Derating (%) (with oil seal)	20	10	10	5
Torque Feature (T-N Curve)				
Insulation Class	Class A (UL), Class B (CE)			
Insulation Resistance	> 100 MΩ, DC 500V			
Insulation Strength	1.8 kVac, 1 sec			
Vibration Level (μm)	V15			
Operating Temperature	0°C - 40°C ^{*3}			
Storage Temperature	-10°C - 80°C ^{*3}			
Storage & Operation Humidity	20 - 90%RH (non-condensing)			
Vibration Capacity	2.5 G			
IP Rating	IP67 (when using waterproof connections and when an oil seal is fitted to the rotating shaft (for an oil seal model))			
Certifications				

Notes:

- In the servo motor model name, \square represents the motor inertia and \square represents the encoder type.
- The rated torque is the continuous permissible torque between 0 to 40°C operating temperature which is suitable for the servo motor mounted with the following heat sink dimensions.
F40, F60, F80: 250 mm x 250 mm x 6 mm
Material: aluminum
- () = motor with brake
- The built-in servo motor brake is only for keeping the object in a stopped state.
Do not use it for deceleration or as a dynamic brake

- Please follow the max. tolerating loading of the motor shaft end listed below during operation

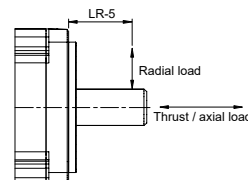

ECM-A3 Series Servo Motor Specifications

Electrical Specifications

Low Inertia Motor ECM-A3L Series / High Inertia Motor ECM-A3H Series

	ECM-A3L-C20804 ^{*1}	ECM-A3L-C20807 ^{*1}	ECM-A3H-C2040F ^{*1}	ECM-A3H-C20401 ^{*1}
Rated Power (kW)	0.4	0.75	0.05	0.1
Rated Torque (N-m) ^{*2}	1.27	2.39	0.159	0.32
Maximum Torque (N-m)	4.44	8.36	0.557	1.12
Rated Speed (rpm)	3000			
Maximum Speed (rpm)	6000			
Rated Current (Arms)	2.6	5.1	0.64	0.9
Max. Instantaneous Current (Arms)	10.6	20.6	2.59	3.64
Rated Power Rate (kW/s) ^{*3}	45.8 (39.5)	102.2 (93)	5.56 (4.89)	13.6 (12.5)
Rotor Inertia ($\times 10^{-4}$ kg.m ²) ^{*3}	0.352 (0.408)	0.559 (0.614)	0.0455 (0.0517)	0.0754 (0.0816)
Mechanical Time Constant (ms) ^{*3}	0.68 (0.78)	0.44 (0.48)	2.52 (2.86)	1.43 (1.55)
Torque Constant -KT (N-m/A)	0.488	0.469	0.248	0.356
Voltage Constant -KE (mV/(rpm))	17.9	17	9.54	12.9
Armature Resistance (Ohm)	1.6	0.6	12.5	8.34
Armature Inductance (mH)	10.6	4.6	13.34	11
Electrical Time Constant (ms)	6.63	7.67	1.07	1.32
Brake Holding Torque [Nt-m (min)] ^{*4}	2.5	2.5	0.32	0.32
Brake Power Consumption (at 20°C)[W]	8	8	6.1	6.1
Brake Release Time [ms (Max.)]	20	20	20	20
Brake Pull-In Time [ms (Max.)]	60	60	35	35
Max. Radial Loading (N) ^{*5}	392	392	78	78
Max. Axial Loading (N) ^{*5}	147	147	54	54
Weight (kg) ^{*3}	2.05 (2.85)	2.8 (3.6)	0.38 (0.68)	0.5 (0.8)
Derating (%) (with oil seal)	5	5	20	10
Torque Feature (T-N Curve)				
Insulation Class	Class A (UL), Class B (CE)			
Insulation Resistance	100 MΩ, DC 500V and above			
Insulation Strength	1.8k Vac, 1 sec			
Vibration Level (μm)	V15			
Operating Temperature	0°C - 40°C* ³			
Storage Temperature	-10°C - 80°C* ³			
Storage & Operation Humidity	20 - 90%RH (non-condensing)			
Vibration Capacity	2.5 G			
IP Rating	IP67 (when using waterproof connections and when an oil seal is fitted to the rotating shaft (for an oil seal model))			
Certifications				



Notes:

- In the servo motor model name, 1 represents the motor inertia and 2 represents the encoder type.
- The rated torque is the continuous permissible torque between 0 to 40°C operating temperature which is suitable for the servo motor mounted with the following heat sink dimensions.
F40, F60, F80: 250 mm x 250 mm x 6 mm
Material: aluminum
- () = motor with brake
- The built-in servo motor brake is only for keeping the object in a stopped state. Do not use it for deceleration or as a dynamic brake.

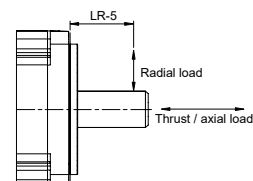
- Please follow the max. tolerant loading of the motor shaft end listed below during operation

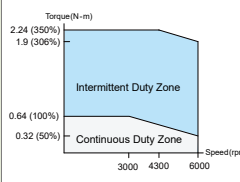
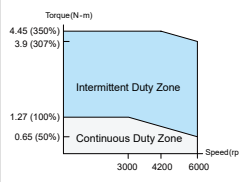
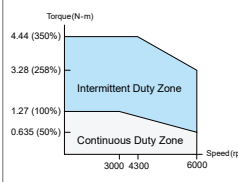
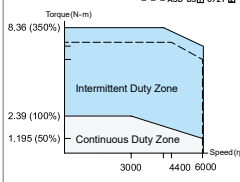

ECM-A3H High Inertia Series Servo Motor

	ECM-A3H-C 20602 ^{*1}	ECM-A3H-C 20604 ^{*1}	ECM-A3H-C 20804 ^{*1}	ECM-A3H-C 20807 ^{*1}
Rated Power (kW)	0.2	0.4	0.4	0.75
Rated Torque (N-m) ^{*2}	0.64	1.27	1.27	2.39
Maximum Torque (N-m)	2.24	4.45	4.44	8.36
Rated Speed (rpm)	3000			
Maximum Speed (rpm)	6000			
Rated Current (Arms)	1.45	2.65	2.6	4.61
Max. Instantaneous Current (Arms)	5.3	9.8	9.32	16.4
Rated Power Rate (kW/s) ^{*3}	16.4 (14.6)	35.8 (33.6)	17.5 (15.07)	37.8 (34.41)
Rotor Inertia ($\times 10^{-4} \text{kg}\cdot\text{m}^2$) ^{*3}	0.25 (0.28)	0.45 (0.48)	0.92 (1.07)	1.51 (1.66)
Mechanical Time Constant (ms) ^{*3}	1.38 (1.54)	0.96 (1.02)	1.32 (1.54)	0.93 (1.02)
Torque Constant -KT (N-m/A)	0.441	0.479	0.49	0.52
Voltage Constant -KE (mV/(rpm))	16.4	17.2	17.9	18.7
Armature Resistance (Ohm)	3.8	1.68	1.19	0.57
Armature Inductance (mH)	8.15	4.03	4.2	2.2
Electrical Time Constant (ms)	2.14	2.40	3.53	3.86
Brake Holding Torque [Nt-m (min)] ^{*4}	1.3	1.3	2.5	2.5
Brake Power Consumption (at 20°C)[W]	7.2	7.2	8	8
Brake Release Time [ms (Max.)]	20	20	20	20
Brake Pull-In Time [ms (Max.)]	50	50	60	60
Max. Radial Loading (N) ^{*5}	245	245	392	392
Max. Axial Loading (N) ^{*5}	74	74	147	147
Weight (kg) ^{*3}	1.1 (1.6)	1.4 (1.9)	2.05 (2.85)	2.8 (3.6)
Derating (%) (with oil seal)	10	5	5	5
Torque Feature (T-N Curve)				
Insulation Class	Class A (UL), Class B (CE)			
Insulation Resistance	100 MΩ, DC 500V and above			
Insulation Strength	1.8k Vac, 1 sec			
Vibration Level (μm)	V15			
Operating Temperature	0°C - 40°C ^{*3}			
Storage Temperature	-10°C - 80°C ^{*3}			
Storage & Operation Humidity	20 - 90%RH (non-condensing)			
Vibration Capacity	2.5 G			
IP Rating	IP67 (when using waterproof connections and when an oil seal is fitted to the rotating shaft (for an oil seal model))			
Certifications				

- Notes:
- In the servo motor model name, [1] represents the motor inertia and [2] represents the encoder type.
 - The rated torque is the continuous permissible torque between 0 to 40°C operating temperature which is suitable for the servo motor mounted with the following heat sink dimensions.
F40, F60, F80: 250 mm x 250 mm x 6 mm
Material: aluminum
 - () = motor with brake
 - The built-in servo motor brake is only for keeping the object in a stopped state.
Do not use it for deceleration or as a dynamic brake
 - Please follow the max. tolerant loading of the motor shaft end listed below during operation

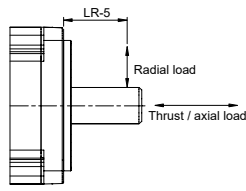

ECM-A3 Series Servo Motor Specifications

Dimensions of Motors with Frame Size of 80 mm or Below

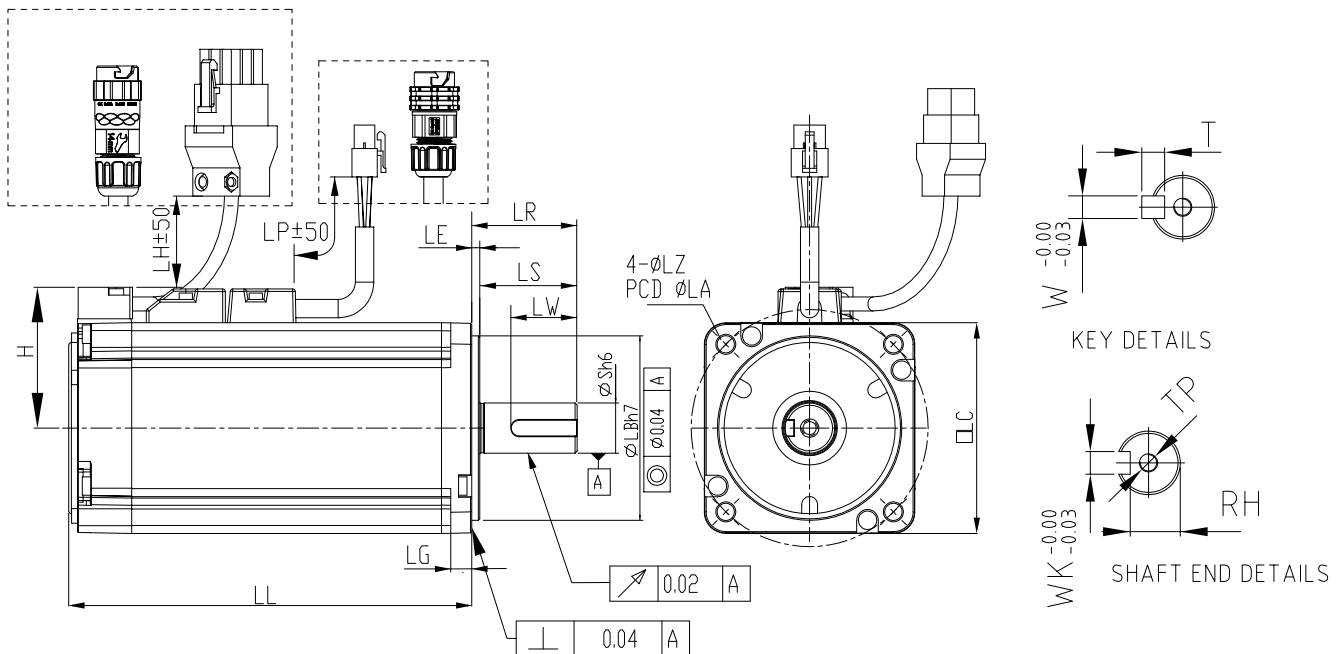

Model	C 2 040F 3 4 5	C 2 0401 3 4 5	C 2 0602 3 4 5	C 2 0604 3 4 5	C 2 0804 3 4 5	C 2 0807 3 4 5
LC	40	40	60	60	80	80
LZ	4.5	4.5	5.5	5.5	6.6	6.6
LA	46	46	70	70	90	90
S	8 ^(+0/-0.009)	8 ^(+0/-0.009)	14 ^(+0/-0.011)	14 ^(+0/-0.011)	14 ^(+0/-0.011)	19 ^(+0/-0.013)
LB	30 ^(+0/-0.021)	30 ^(+0/-0.021)	50 ^(+0/-0.025)	50 ^(+0/-0.025)	70 ^(+0/-0.030)	70 ^(+0/-0.030)
LL (w/o brake)	70.6	85.3	84	106	93.7	115.8
LL (with brake)	105.4	120.1	117.6	139.7	131.2	153.2
LH	300	300	300	300	300	300
LP	300	300	300	300	300	300
H	34	34	43.5	43.5	54.5	54.5
LS	21.5	21.5	27	27	27	37
LR	25	25	30	30	30	40
LE	2.5	2.5	3	3	3	3
LG	5	5	7.5	7.5	8	8
LW	16	16	20	20	20	25
RH	6.2	6.2	11	11	11	15.5
WK	3	3	5	5	5	6
W	3	3	5	5	5	6
T	3	3	5	5	5	6
TP	M3 Depth 6	M3 Depth 6	M4 Depth 8	M4 Depth 8	M4 Depth 8	M6 Depth 10

Notes:

1. In the servo motor model name, 2 represents the encoder type, 3 represents the brake or keyway / oil seal type, 4 represents the shaft diameter and connector type, and 5 represents the special code.
2. When the special code of the C2 0807 3 4 5 model is Z, then its LS = 32 and LR = 35.
4. When the 4 in the motor model name is J or K, the connector is an IP67 waterproof connector

Control Mode Wiring

Position (PT) Mode Standard Wiring (Differential Pulse Signals)

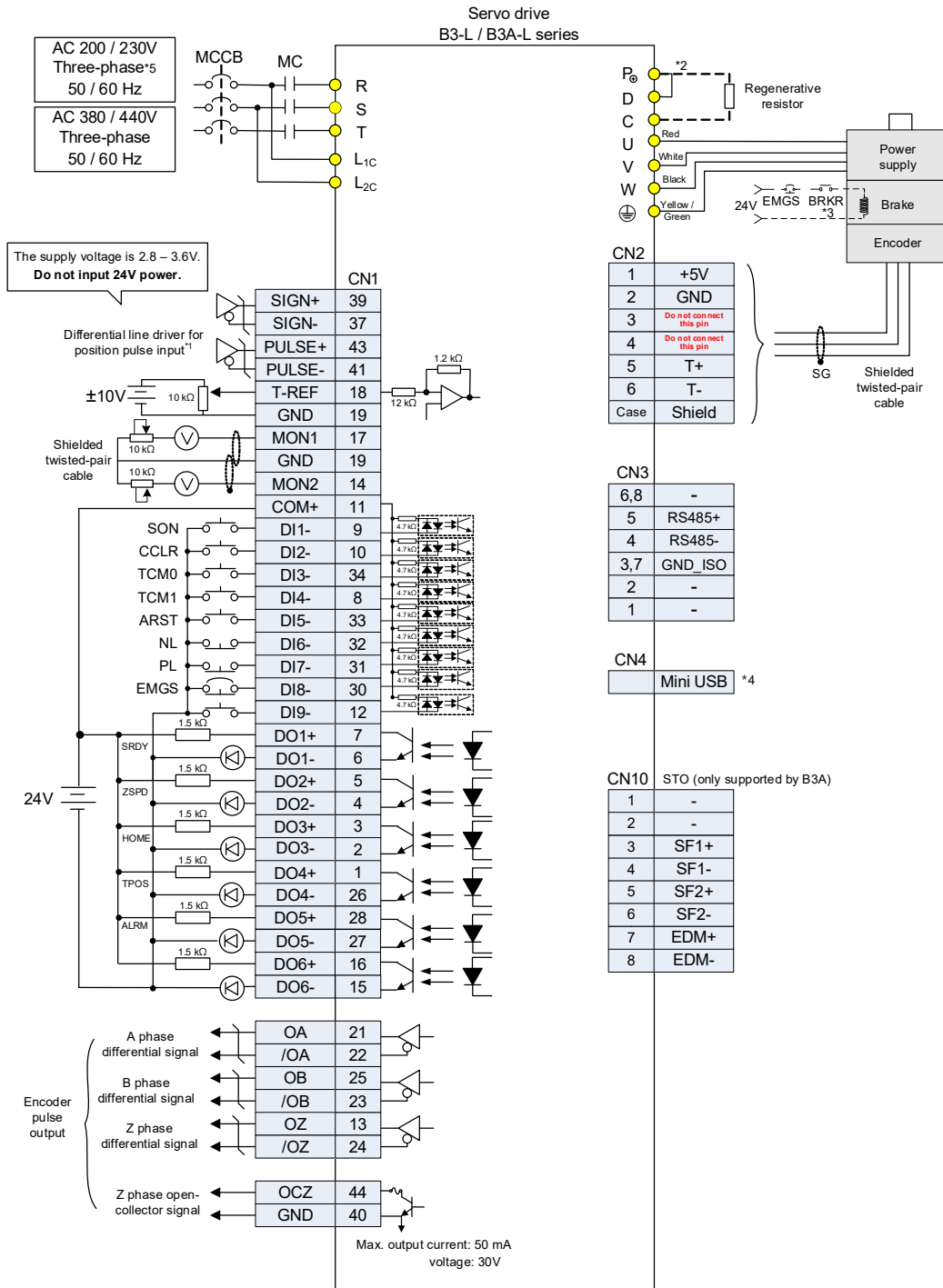

Notes:

- *1: Refer to Section 3.3.7 in the ASDA-B3 user manual for CN1 wiring
- *2: Models of 200 W and below have no built-in brake resistor
- *3: The brake coil has no polarity
- *4: Connects to Mini USB (for PC communication)
- *5: Models of 1.5 kW and below can use single-phase power supply

Control Mode Wiring

Position (PT) Control Mode (Open-Collector Pulse Signals)

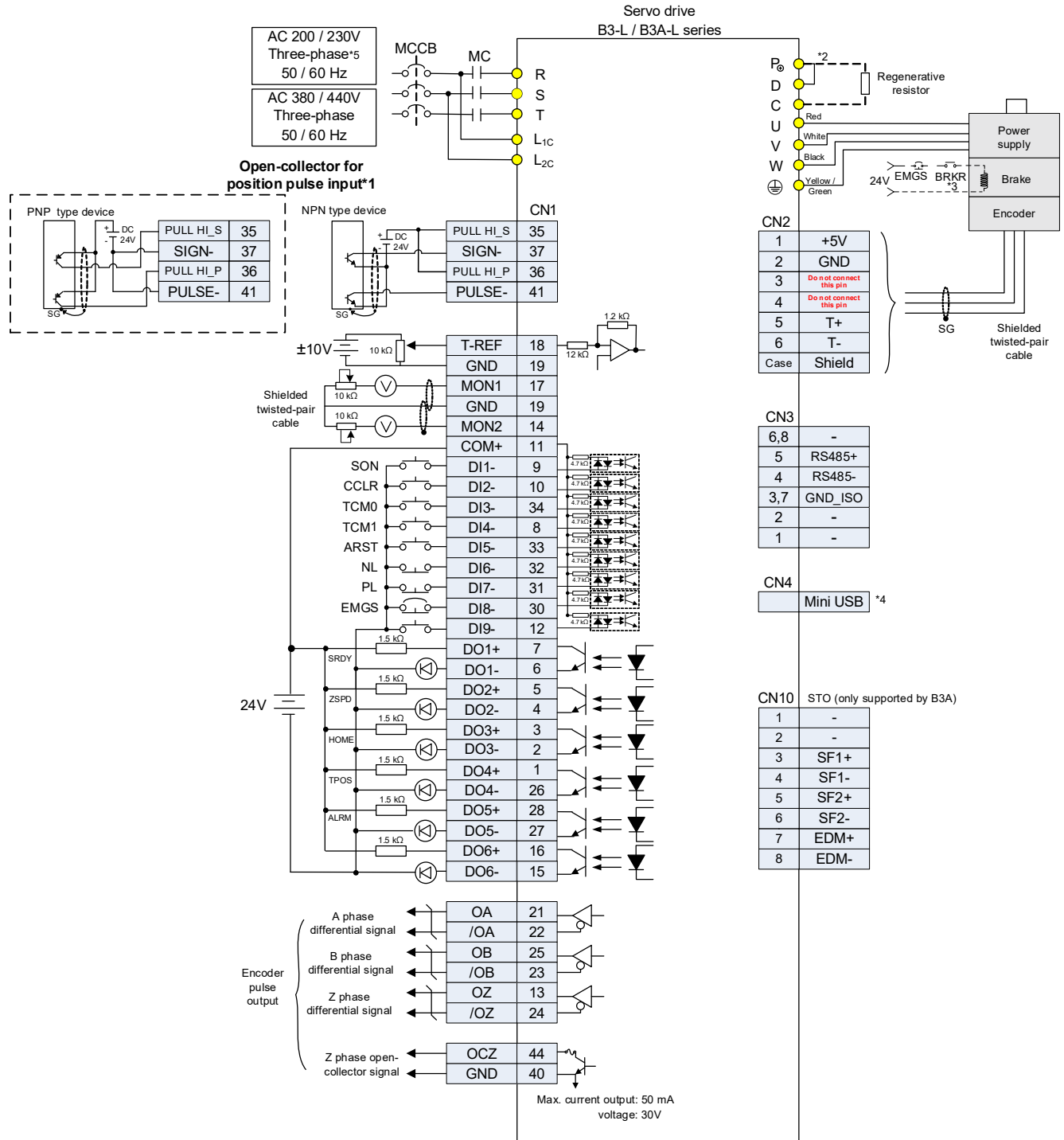

Notes:

- *1: Refer to Section 3.3.7 in the ASDA-B3 user manual for CN1 wiring
- *2: Models of 200 W and below have no built-in brake resistor
- *3: The brake coil has no polarity
- *4: Connects to Mini USB (for PC communication)
- *5: Models of 1.5 kW and below can use single-phase power supply

Position (PR) Mode Standard Wiring (Internal Position Commands)

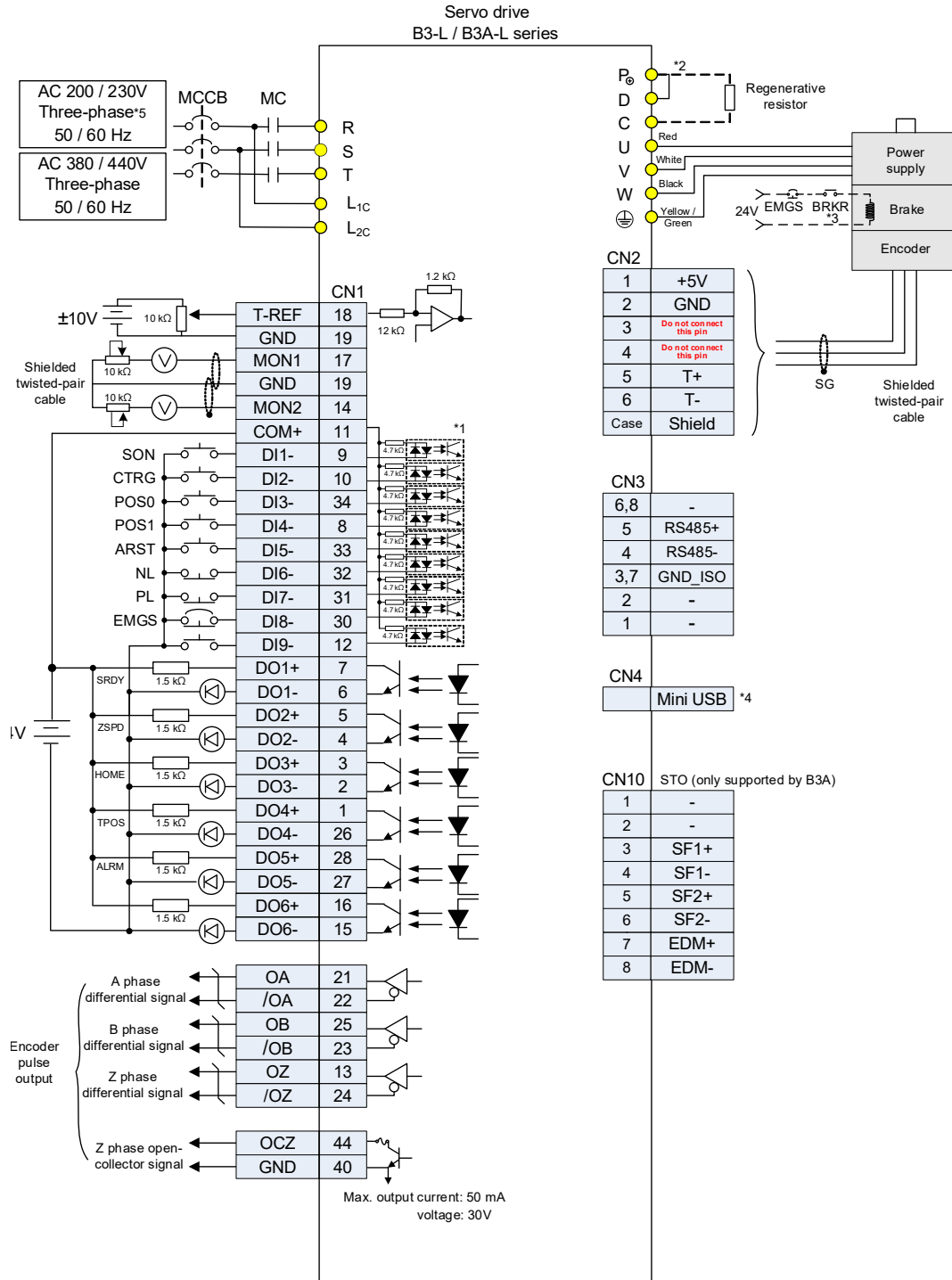

Notes:

- *1: Refer to Section 3.3.7 in the ASDA-B3 user manual for CN1 wiring
- *2: Models of 200 W and below have no built-in brake resistor
- *3: The brake coil has no polarity
- *4: Connects to Mini USB (for PC communication)
- *5: Models of 1.5 kW and below can use single-phase power supply

Control Mode Wiring

Torque (T) Mode Standard Wiring

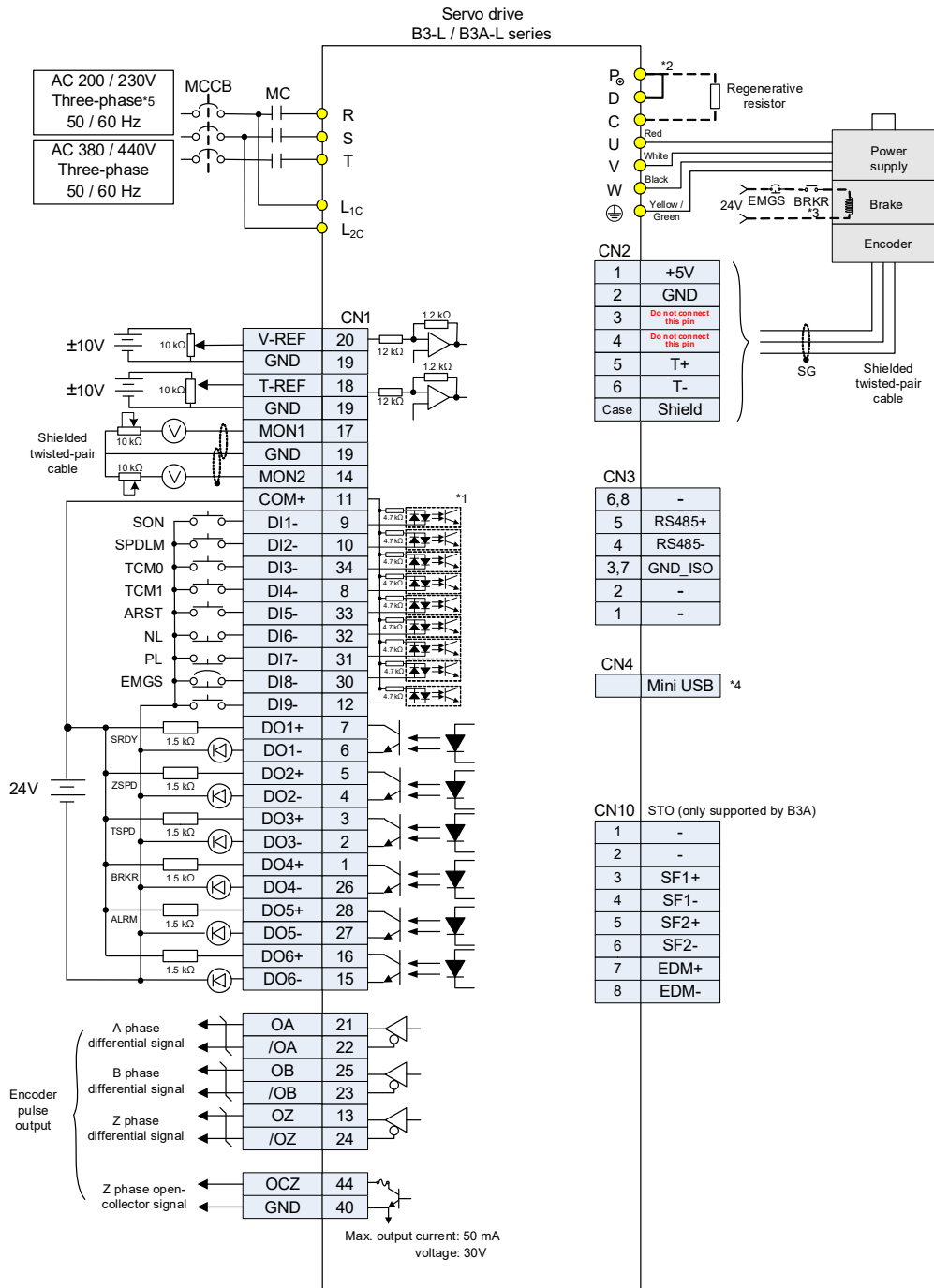

Notes:

- *1: Refer to Section 3.3.7 in the ASDA-B3 user manual for CN1 wiring
- *2: Models of 200 W and below have no built-in brake resistor
- *3: The brake coil has no polarity
- *4: Connects to Mini USB (for PC communication)
- *5: Models of 1.5 kW and below can use single-phase power supply

Speed (S) Mode Standard Wiring

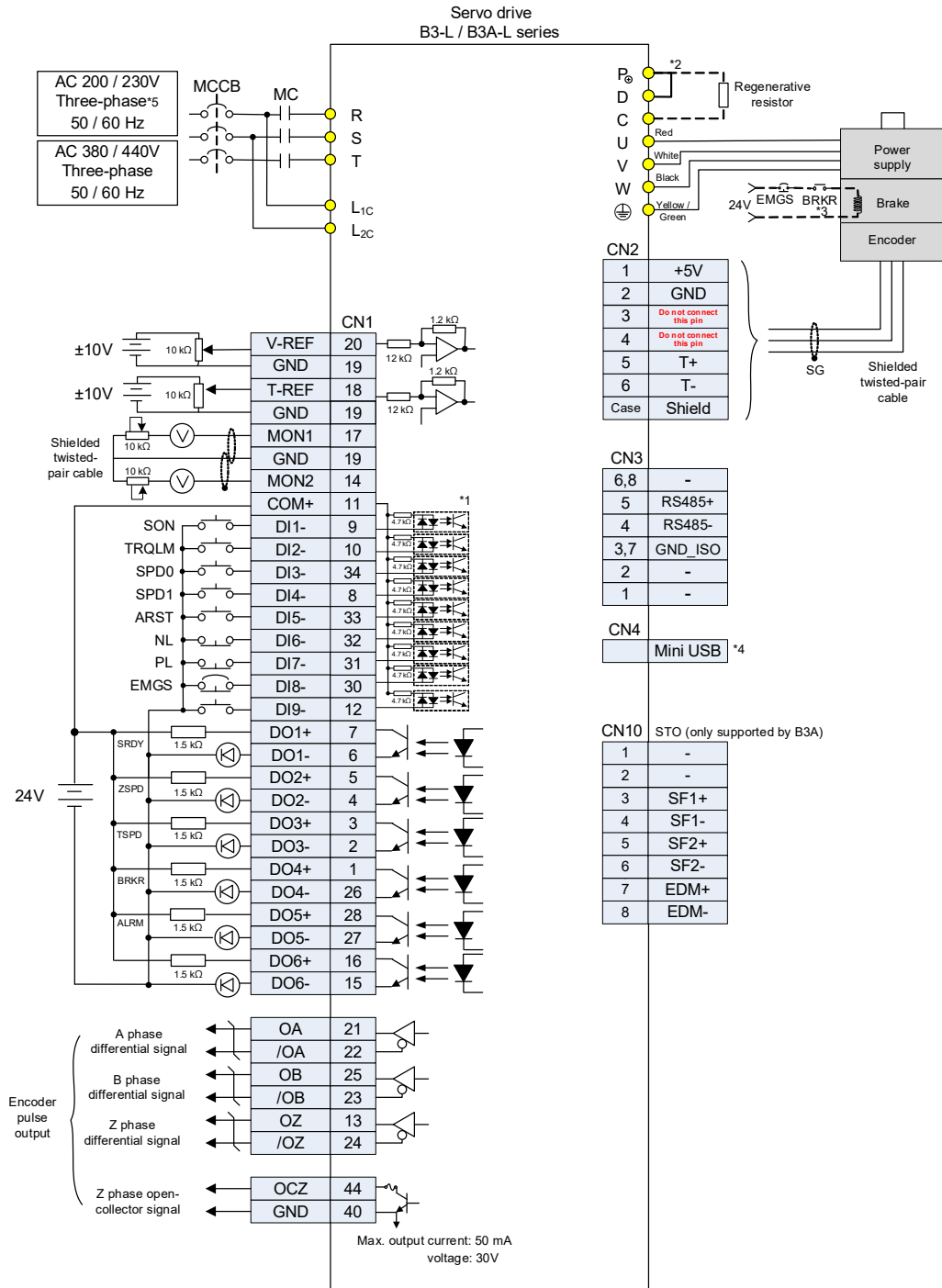

- Notes:
- *1: Refer to Section 3.3.7 in the ASDA-B3 user manual for CN1 wiring
 - *2: Models of 200 W and below have no built-in brake resistor
 - *3: The brake coil has no polarity
 - *4: Connects to Mini USB (for PC communication)
 - *5: Models of 1.5 kW and below can use single-phase power supply

Control Mode Wiring

CANopen Communication Mode Standard Wiring

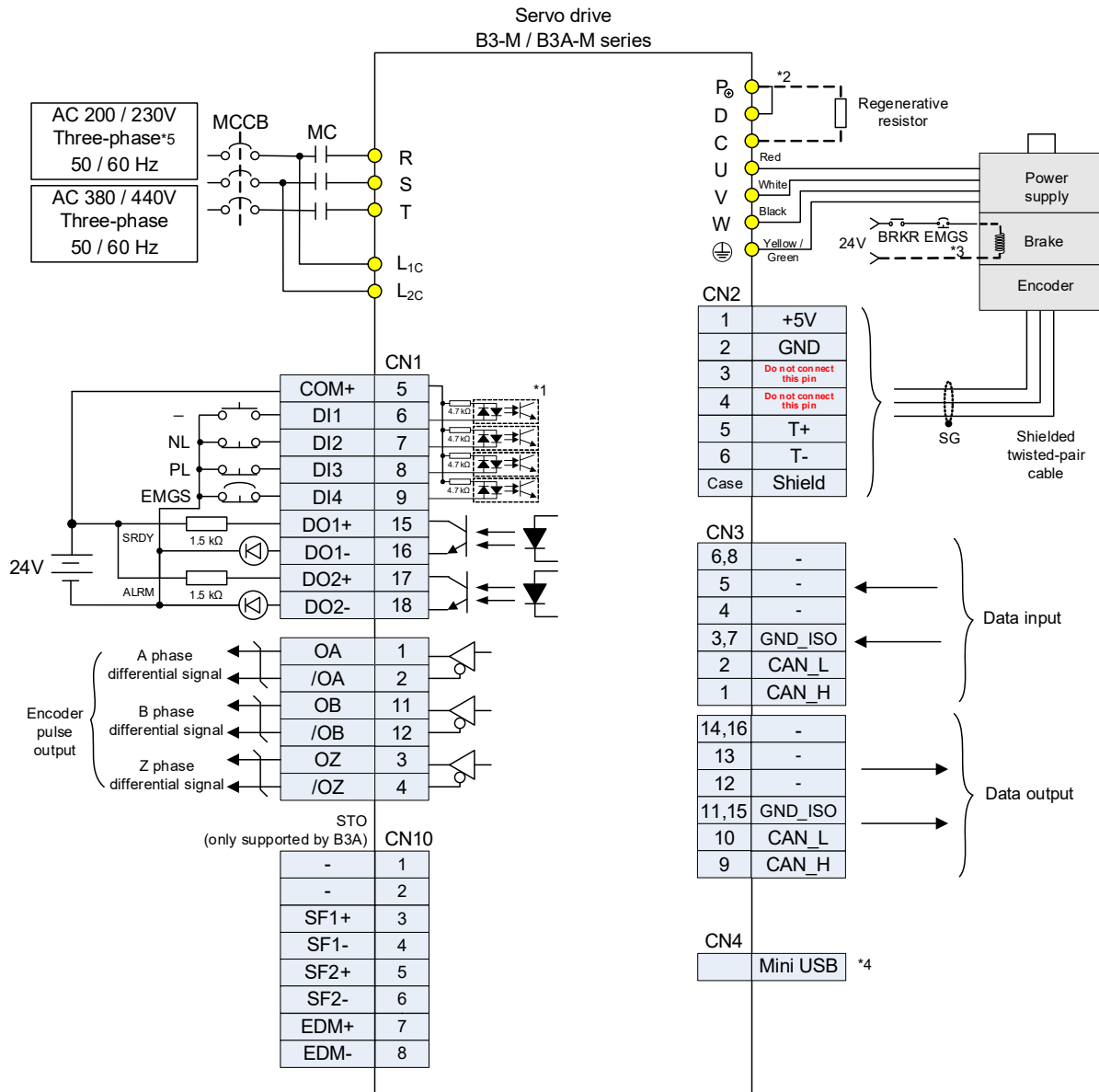

Notes:

- *1: Refer to Section 3.3.7 in the ASDA-B3 user manual for CN1 wiring
- *2: Models of 200 W and below have no built-in brake resistor
- *3: The brake coil has no polarity
- *4: Connects to Mini USB (for PC communication)
- *5: Models of 1.5 kW and below can use single-phase power supply

DMCNET Communication Mode Standard Wiring

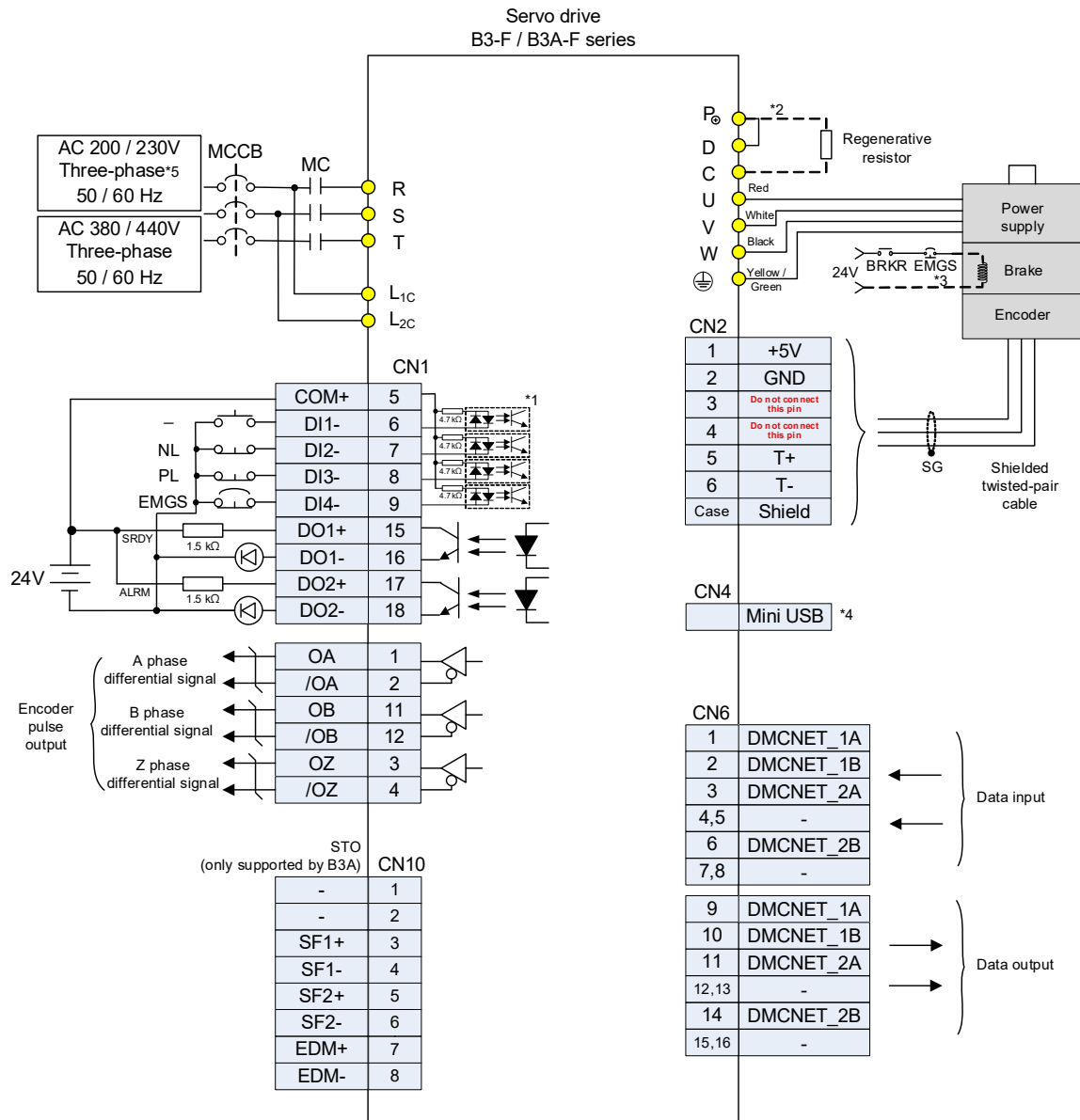

Notes:

- *1: Refer to Section 3.3.7 in the ASDA-B3 user manual for CN1 wiring
- *2: Models of 200 W and below have no built-in brake resistor
- *3: The brake coil has no polarity
- *4: Connects to Mini USB (for PC communication)
- *5: Models of 1.5 kW and below can use single-phase power supply

Control Mode Wiring

EtherCAT Communication Mode Standard Wiring

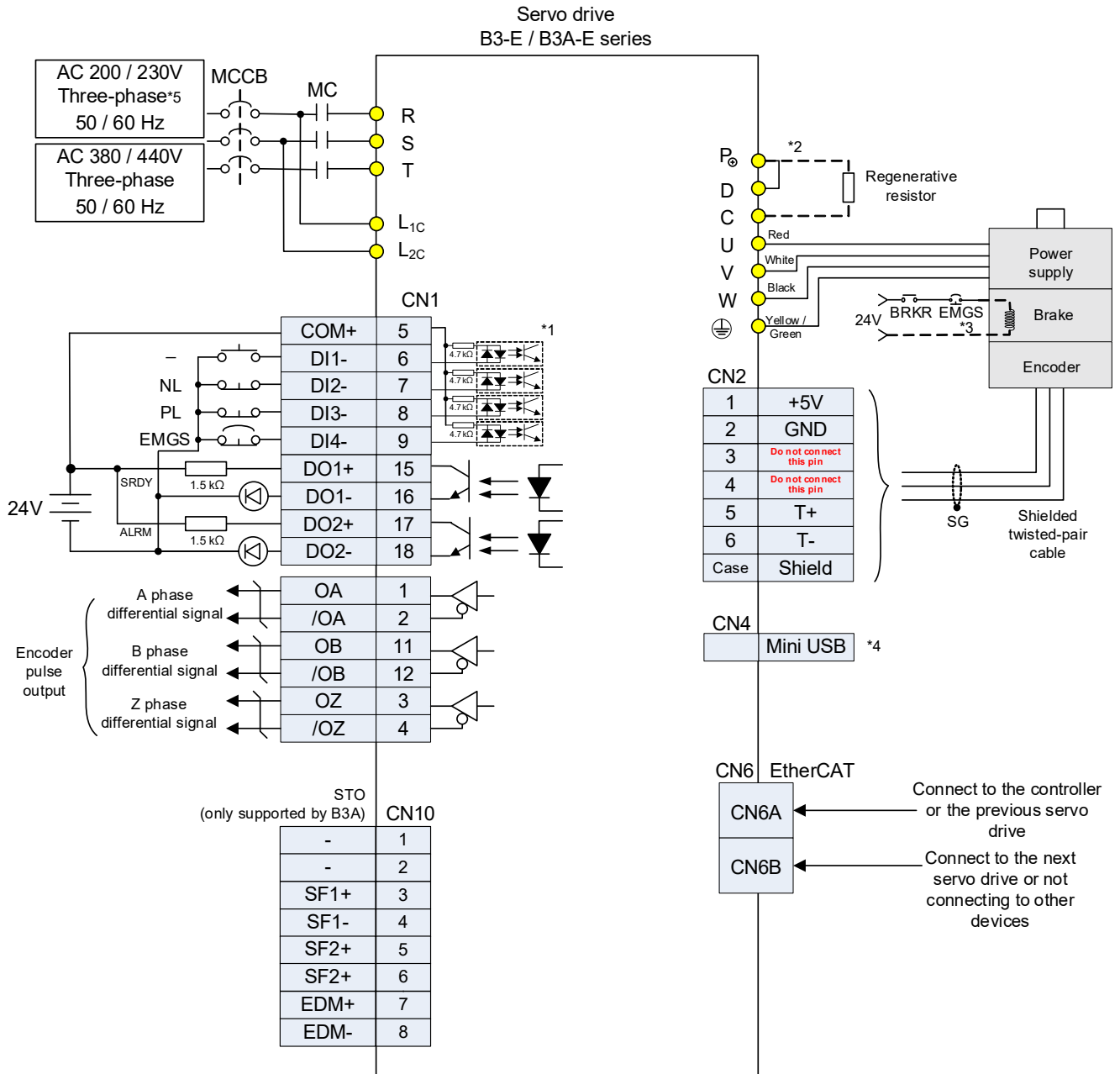

Notes:

- *1: Refer to Section 3.3.7 in the ASDA-B3 user manual for CN1 wiring
- *2: Models of 200 W and below have no built-in brake resistor
- *3: The brake coil has no polarity
- *4: Connects to Mini USB (for PC communication)
- *5: Models of 1.5 kW and below can use single-phase power supply

Ordering Information

Accessories

Power Connectors

ASDBCAPW0000 (Motor 220V & 400V)
(for F80 and below)

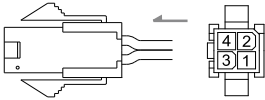

ACS3-CAPWA000
(for F100 - F130)
Mil-Spec: MIL 3106A18-10S

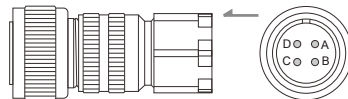

ACS3-CAPWE000
(for F180 5.5/7.5 kW & F200)
Mil-Spec: MIL 3106A32-17S

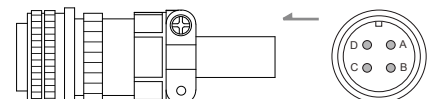

ASDBCAPW0100 (Motor 220V & 400V)
(for F80 and below with brake)

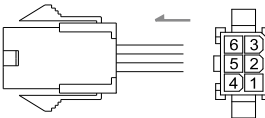

ACS3-CRPWA000
(for F100 - F130)
Mil-Spec: MIL 3108A18-10S

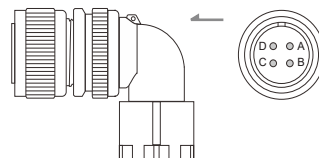

ACS3-CRPWE000
(for F180 5.5/7.5 kW & F200)
Mil-Spec: MIL 3108A32-17S

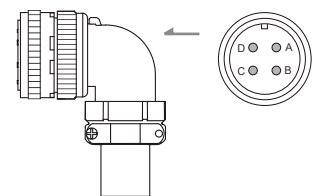

ACS3-CNPW1A00
(for F80 and below)
IP67 waterproof connector, for 220V

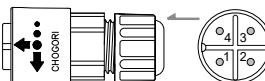

ACS3-CAPWC000
(for F180 2/3/4.5 kW)
Mil-Spec: MIL 3106A22-22S

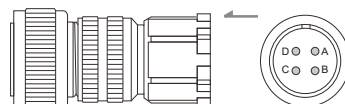

ACS3-CABRA000
(for F100 - F220 with brake)
Mil-Spec: CMV1-SP2S

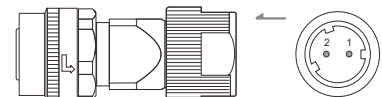

ACS3-CNPW2A00
(for F80 and below)
IP67 waterproof connector, for 220V

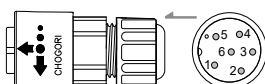

ACS3-CRPWC000
(for F180 2/3/4.5 kW)
Mil-Spec: MIL 3108A22-22S

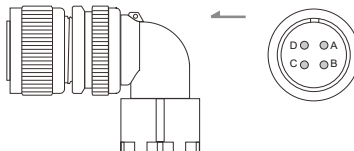

ACS3-CRBRA000
(for F100 - F220 with brake)
Mil-Spec: CMV1-AP2S

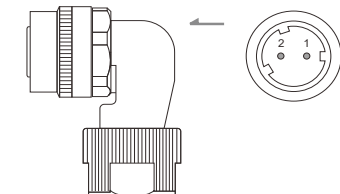

Ordering Information

Accessories

Power Cable

F40 - F80

A3/B3 motor, w/o brake, 220V

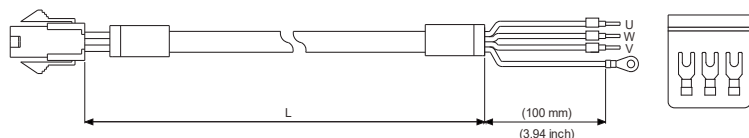

Cable	Model Name	UVW	L	
		AWG (mm ²)	mm	inch
Standard	ACS3-CAPW1103	18 (0.82)	3000 ± 50	118 ± 2
	ACS3-CAPW1105	18 (0.82)	5000 ± 50	197 ± 2
	ACS3-CAPW1110	18 (0.82)	10000 ± 50	394 ± 4
	ACS3-CAPW1120	18 (0.82)	20000 ± 50	787 ± 4
Torsion-Resistant	ACS3-CAPF1103	18 (0.82)	3000 ± 50	118 ± 2
	ACS3-CAPF1105	18 (0.82)	5000 ± 50	197 ± 2
	ACS3-CAPF1110	18 (0.82)	10000 ± 50	394 ± 4
	ACS3-CAPF1120	18 (0.82)	20000 ± 50	787 ± 4

F40 - F80

A3/B3 motor, w/o brake, 400V

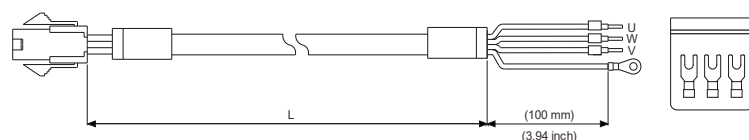

Cable	Model Name	UVW	L	
		AWG (mm ²)	mm	inch
Standard	ACS3-CAPW3103	18 (0.82)	3000 ± 50	118 ± 2
	ACS3-CAPW3105	18 (0.82)	5000 ± 50	197 ± 2
	ACS3-CAPW3110	18 (0.82)	10000 ± 50	394 ± 4
	ACS3-CAPW3120	18 (0.82)	20000 ± 50	787 ± 4
Torsion-Resistant	ACS3-CAPF3103	18 (0.82)	3000 ± 50	118 ± 2
	ACS3-CAPF3105	18 (0.82)	5000 ± 50	197 ± 2
	ACS3-CAPF3110	18 (0.82)	10000 ± 50	394 ± 4
	ACS3-CAPF3120	18 (0.82)	20000 ± 50	787 ± 4

F40 - F80

A3/B3 motor, w/o brake, IP67 waterproof connector, 220V

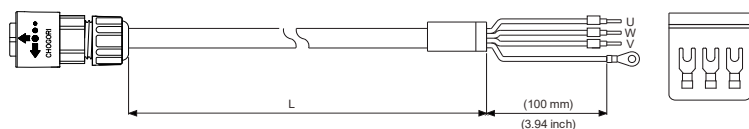

Cable	Model Name	UVW	L	
		AWG (mm ²)	mm	inch
Standard	ACS3-CAPW5103	18 (0.82)	3000 ± 50	118 ± 2
	ACS3-CAPW5105	18 (0.82)	5000 ± 50	197 ± 2
	ACS3-CAPW5110	18 (0.82)	10000 ± 100	394 ± 4
	ACS3-CAPW5120	18 (0.82)	20000 ± 100	787 ± 4
Torsion-Resistant	ACS3-CAPF5103	18 (0.82)	3000 ± 50	118 ± 2
	ACS3-CAPF5105	18 (0.82)	5000 ± 50	197 ± 2
	ACS3-CAPF5110	18 (0.82)	10000 ± 100	394 ± 4
	ACS3-CAPF5120	18 (0.82)	20000 ± 100	787 ± 4

F40 - F80

A3/B3 motor, with brake (220V & 400V)

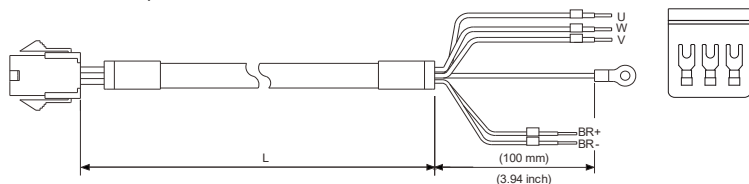

Cable	Model Name	UVW	L	
		AWG (mm ²)	mm	inch
Standard	ACS3-CAPW2103	18 (0.82)	3000 ± 50	118 ± 2
	ACS3-CAPW2105	18 (0.82)	5000 ± 50	197 ± 2
	ACS3-CAPW2110	18 (0.82)	10000 ± 100	394 ± 4
	ACS3-CAPW2120	18 (0.82)	20000 ± 100	787 ± 4
Torsion-Resistant	ACS3-CAPF2103	18 (0.82)	3000 ± 50	118 ± 2
	ACS3-CAPF2105	18 (0.82)	5000 ± 50	197 ± 2
	ACS3-CAPF2110	18 (0.82)	10000 ± 100	394 ± 4
	ACS3-CAPF2120	18 (0.82)	20000 ± 100	787 ± 4

F40 - F80

A3/B3 motor, with brake, IP67 waterproof connector, 220V

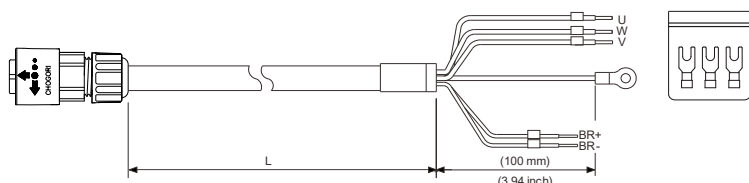

Cable	Model Name	UVW	L	
		AWG (mm ²)	mm	inch
Standard	ACS3-CAPW6103	18 (0.82)	3000 ± 50	118 ± 2
	ACS3-CAPW6105	18 (0.82)	5000 ± 50	197 ± 2
	ACS3-CAPW6110	18 (0.82)	10000 ± 100	394 ± 4
	ACS3-CAPW6120	18 (0.82)	20000 ± 100	787 ± 4
Torsion-Resistant	ACS3-CAPF6103	18 (0.82)	3000 ± 50	118 ± 2
	ACS3-CAPF6105	18 (0.82)	5000 ± 50	197 ± 2
	ACS3-CAPF6110	18 (0.82)	10000 ± 100	394 ± 4
	ACS3-CAPF6120	18 (0.82)	20000 ± 100	787 ± 4

Power Cable

F100 - F130

B3 motor, w/o brake, straight connector

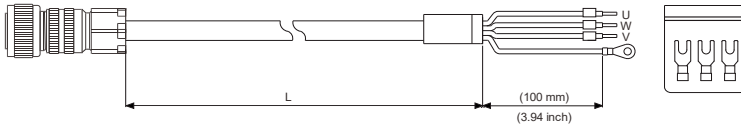

Cable	Model Name	UVW		L	
		AWG (mm ²)	mm	mm	inch
Standard	ACS3-CAPWA203	16 (1.3)	3000 ± 50	118 ± 2	
	ACS3-CAPWA205	16 (1.3)	5000 ± 50	197 ± 2	
	ACS3-CAPWA210	16 (1.3)	10000 ± 100	394 ± 4	
	ACS3-CAPWA220	16 (1.3)	20000 ± 100	787 ± 4	
	ACS3-CAPWA303	14 (2.1)	3000 ± 50	118 ± 2	
	ACS3-CAPWA305	14 (2.1)	5000 ± 50	197 ± 2	
	ACS3-CAPWA310	14 (2.1)	10000 ± 100	394 ± 4	
	ACS3-CAPWA320	14 (2.1)	20000 ± 100	787 ± 4	
Torsion-Resistant	ACS3-CAPFA203	16 (1.3)	3000 ± 50	118 ± 2	
	ACS3-CAPFA205	16 (1.3)	5000 ± 50	197 ± 2	
	ACS3-CAPFA210	16 (1.3)	10000 ± 100	394 ± 4	
	ACS3-CAPFA220	16 (1.3)	20000 ± 100	787 ± 4	
	ACS3-CAPFA303	14 (2.1)	3000 ± 50	118 ± 2	
	ACS3-CAPFA305	14 (2.1)	5000 ± 50	197 ± 2	
	ACS3-CAPFA310	14 (2.1)	10000 ± 100	394 ± 4	
	ACS3-CAPFA320	14 (2.1)	20000 ± 100	787 ± 4	

F100 - F130

B3 motor, w/o brake, angular connector

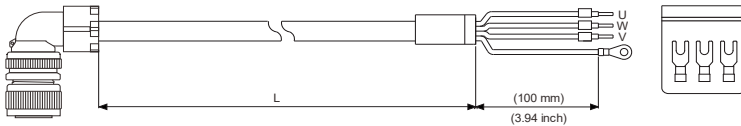

Cable	Model Name	UVW		L	
		AWG (mm ²)	mm	mm	inch
Standard	ACS3-CRPWA203	16 (1.3)	3000 ± 50	118 ± 2	
	ACS3-CRPWA205	16 (1.3)	5000 ± 50	197 ± 2	
	ACS3-CRPWA210	16 (1.3)	10000 ± 100	394 ± 4	
	ACS3-CRPWA220	16 (1.3)	20000 ± 100	787 ± 4	
	ACS3-CRPWA303	14 (2.1)	3000 ± 50	118 ± 2	
	ACS3-CRPWA305	14 (2.1)	5000 ± 50	197 ± 2	
	ACS3-CRPWA310	14 (2.1)	10000 ± 100	394 ± 4	
	ACS3-CRPWA320	14 (2.1)	20000 ± 100	787 ± 4	
Torsion-Resistant	ACS3-CRPFA203	16 (1.3)	3000 ± 50	118 ± 2	
	ACS3-CRPFA205	16 (1.3)	5000 ± 50	197 ± 2	
	ACS3-CRPFA210	16 (1.3)	10000 ± 100	394 ± 4	
	ACS3-CRPFA220	16 (1.3)	20000 ± 100	787 ± 4	
	ACS3-CRPFA303	14 (2.1)	3000 ± 50	118 ± 2	
	ACS3-CRPFA305	14 (2.1)	5000 ± 50	197 ± 2	
	ACS3-CRPFA310	14 (2.1)	10000 ± 100	394 ± 4	
	ACS3-CRPFA320	14 (2.1)	20000 ± 100	787 ± 4	

F180, 2/3/4.5kW

B3 motor, w/o brake, straight connector

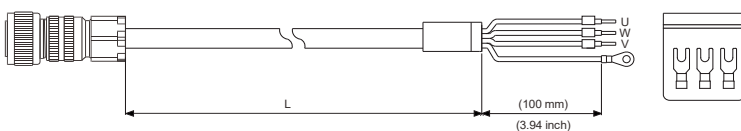

Cable	Model Name	UVW		L	
		AWG (mm ²)	mm	mm	inch
Standard	ACS3-CAPWC403	12 (3.3)	3000 ± 50	118 ± 2	
	ACS3-CAPWC405	12 (3.3)	5000 ± 50	197 ± 2	
	ACS3-CAPWC410	12 (3.3)	10000 ± 100	394 ± 4	
	ACS3-CAPWC420	12 (3.3)	20000 ± 100	787 ± 4	
	ACS3-CAPWC503	10 (5.3)	3000 ± 50	118 ± 2	
	ACS3-CAPWC505	10 (5.3)	5000 ± 50	197 ± 2	
	ACS3-CAPWC510	10 (5.3)	10000 ± 100	394 ± 4	
	ACS3-CAPWC520	10 (5.3)	20000 ± 100	787 ± 4	
Torsion-Resistant	ACS3-CAPFC403	12 (3.3)	3000 ± 50	118 ± 2	
	ACS3-CAPFC405	12 (3.3)	5000 ± 50	197 ± 2	
	ACS3-CAPFC410	12 (3.3)	10000 ± 100	394 ± 4	
	ACS3-CAPFC420	12 (3.3)	20000 ± 100	787 ± 4	
	ACS3-CAPFC503	10 (5.3)	3000 ± 50	118 ± 2	
	ACS3-CAPFC505	10 (5.3)	5000 ± 50	197 ± 2	
	ACS3-CAPFC510	10 (5.3)	10000 ± 100	394 ± 4	
	ACS3-CAPFC520	10 (5.3)	20000 ± 100	787 ± 4	

Ordering Information

Accessories

Power Cable

F180, 2/3/4.5 kW

B3 motor, w/o brake, angular connector

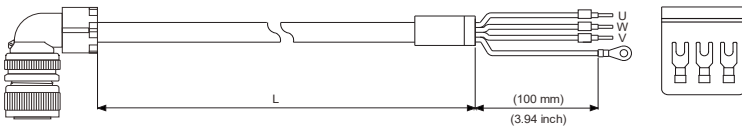

F180, 5.5/7.5 kW

B3 motor, w/o brake, straight connector

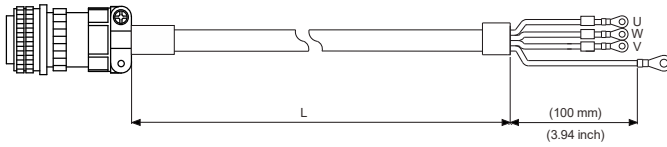

F180, 5.5/7.5 kW

B3 motor, w/o brake, angular connector

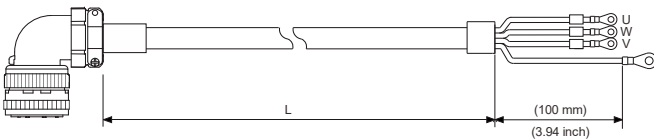

F100 - F220 Brake Cable

B3 motor, with brake, straight connector

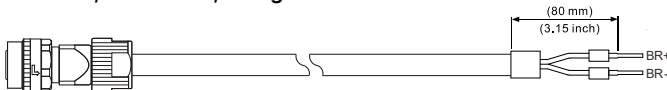

F100 - F220 Brake Cable

B3 motor, with brake, angular connector

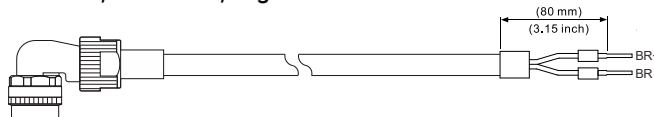

Cable	Model Name	UVW	L	
		AWG (mm ²)	mm	inch
Standard	ACS3-CRPWC403	12 (3.3)	3000 ± 50	118 ± 2
	ACS3-CRPWC405	12 (3.3)	5000 ± 50	197 ± 2
	ACS3-CRPWC410	12 (3.3)	10000 ± 100	394 ± 4
	ACS3-CRPWC420	12 (3.3)	20000 ± 100	787 ± 4
	ACS3-CRPWC503	10 (5.3)	3000 ± 50	118 ± 2
	ACS3-CRPWC505	10 (5.3)	5000 ± 50	197 ± 2
	ACS3-CRPWC510	10 (5.3)	10000 ± 100	394 ± 4
	ACS3-CRPWC520	10 (5.3)	20000 ± 100	787 ± 4
Torsion-Resistant	ACS3-CRPFC403	12 (3.3)	3000 ± 50	118 ± 2
	ACS3-CRPFC405	12 (3.3)	5000 ± 50	197 ± 2
	ACS3-CRPFC410	12 (3.3)	10000 ± 100	394 ± 4
	ACS3-CRPFC420	12 (3.3)	20000 ± 100	787 ± 4
	ACS3-CRPFC503	10 (5.3)	3000 ± 50	118 ± 2
	ACS3-CRPFC505	10 (5.3)	5000 ± 50	197 ± 2
	ACS3-CRPFC510	10 (5.3)	10000 ± 100	394 ± 4
	ACS3-CRPFC520	10 (5.3)	20000 ± 100	787 ± 4

Cable	Model Name	UVW	L	
		AWG (mm ²)	mm	inch
Standard	ACS3-CAPWE603	8 (8.4)	3000 ± 50	118 ± 2
	ACS3-CAPWE605	8 (8.4)	5000 ± 50	197 ± 2
	ACS3-CAPWE610	8 (8.4)	10000 ± 100	394 ± 4
	ACS3-CAPWE620	8 (8.4)	20000 ± 100	787 ± 4
Torsion-Resistant	ACS3-CAPFE603	8 (8.4)	3000 ± 50	118 ± 2
	ACS3-CAPFE605	8 (8.4)	5000 ± 50	197 ± 2
	ACS3-CAPFE610	8 (8.4)	10000 ± 100	394 ± 4
	ACS3-CAPFE620	8 (8.4)	20000 ± 100	787 ± 4

Cable	Model Name	UVW	L	
		AWG (mm ²)	mm	inch
Standard	ACS3-CRPWE603	8 (8.4)	3000 ± 50	118 ± 2
	ACS3-CRPWE605	8 (8.4)	5000 ± 50	197 ± 2
	ACS3-CRPWE610	8 (8.4)	10000 ± 100	394 ± 4
	ACS3-CRPWE620	8 (8.4)	20000 ± 100	787 ± 4
Torsion-Resistant	ACS3-CRPFE603	8 (8.4)	3000 ± 50	118 ± 2
	ACS3-CRPFE605	8 (8.4)	5000 ± 50	197 ± 2
	ACS3-CRPFE610	8 (8.4)	10000 ± 100	394 ± 4
	ACS3-CRPFE620	8 (8.4)	20000 ± 100	787 ± 4

Cable	Model Name	UVW	L	
		AWG (mm ²)	mm	inch
Standard	ACS3-CABRA103	20 (0.5)	3000 ± 50	118 ± 2
	ACS3-CABRA105	20 (0.5)	5000 ± 50	197 ± 2
	ACS3-CABRA110	20 (0.5)	10000 ± 100	394 ± 4
	ACS3-CABRA120	20 (0.5)	20000 ± 100	787 ± 4
Torsion-Resistant	ACS3-CABFA103	20 (0.5)	3000 ± 50	118 ± 2
	ACS3-CABFA105	20 (0.5)	5000 ± 50	197 ± 2
	ACS3-CABFA110	20 (0.5)	10000 ± 100	394 ± 4
	ACS3-CABFA120	20 (0.5)	20000 ± 100	787 ± 4

Cable	Model Name	UVW	L	
		AWG (mm ²)	mm	inch
Standard	ACS3-CRBRA103	20 (0.5)	3000 ± 50	118 ± 2
	ACS3-CRBRA105	20 (0.5)	5000 ± 50	197 ± 2
	ACS3-CRBRA110	20 (0.5)	10000 ± 100	394 ± 4
	ACS3-CRBRA120	20 (0.5)	20000 ± 100	787 ± 4
Torsion-Resistant	ACS3-CRBFA103	20 (0.5)	3000 ± 50	118 ± 2
	ACS3-CRBFA105	20 (0.5)	5000 ± 50	197 ± 2
	ACS3-CRBFA110	20 (0.5)	10000 ± 100	394 ± 4
	ACS3-CRBFA120	20 (0.5)	20000 ± 100	787 ± 4

Encoder Connectors

ACS3-CNENC200
(connecting to drive)

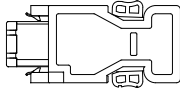

ACS3-CNEN2700
(for F100 - F180)
Mil-Spec: CMV1-SP10S

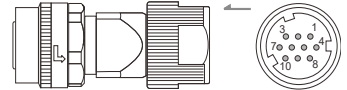

ACS3-CNEN1000
(for F80 and below)

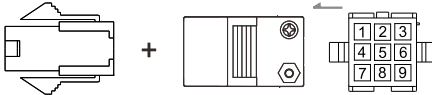

ACS3-CNEN2C00
(for F100 - F180)
Mil-Spec: CMV1-AP10S

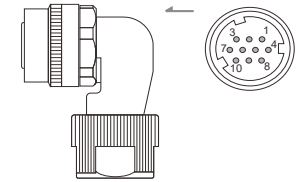

ACS3-CNEN2A00
(for F80 and below)
IP67 waterproof connector

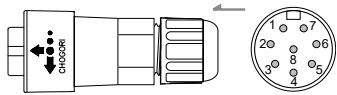

Encoder Cable (Incremental Type)

F40 - F80

B3 motor, w/o brake, straight connector

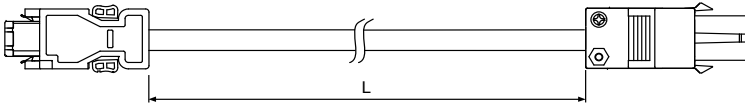

Cable	Model Name	L	
		mm	inch
Standard	ACS3-CAEN0103	3000 ± 50	118 ± 2
	ACS3-CAEN0105	5000 ± 50	197 ± 2
	ACS3-CAEN0110	10000 ± 100	394 ± 4
	ACS3-CAEN0120	20000 ± 100	787 ± 4
Torsion-Resistant	ACS3-CAEF0103	3000 ± 50	118 ± 2
	ACS3-CAEF0105	5000 ± 50	197 ± 2
	ACS3-CAEF0110	10000 ± 100	394 ± 4
	ACS3-CAEF0120	20000 ± 100	787 ± 4

F40 - F80

A3/B3 motor, IP67 waterproof connector

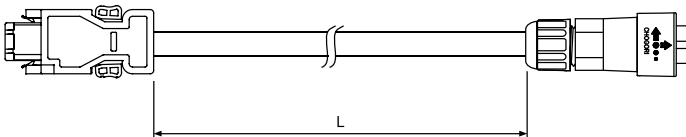

Cable	Model Name	L	
		mm	inch
Standard	ACS3-CAEN1103	3000 ± 50	118 ± 2
	ACS3-CAEN1105	5000 ± 50	197 ± 2
	ACS3-CAEN1110	10000 ± 100	394 ± 4
	ACS3-CAEN1120	20000 ± 100	787 ± 4
Torsion-Resistant	ACS3-CAEF1103	3000 ± 50	118 ± 2
	ACS3-CAEF1105	5000 ± 50	197 ± 2
	ACS3-CAEF1110	10000 ± 100	394 ± 4
	ACS3-CAEF1120	20000 ± 100	787 ± 4

F100 - F180

B3 motor, straight connector

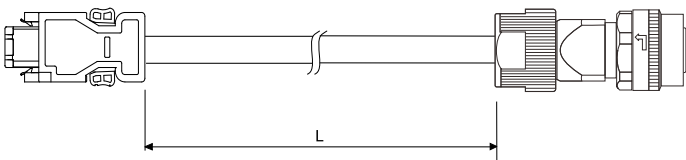

Cable	Model Name	L	
		mm	inch
Standard	ACS3-CAENA103	3000 ± 50	118 ± 2
	ACS3-CAENA105	5000 ± 50	197 ± 2
	ACS3-CAENA110	10000 ± 100	394 ± 4
	ACS3-CAENA120	20000 ± 100	787 ± 4
Torsion-Resistant	ACS3-CAEFA103	3000 ± 50	118 ± 2
	ACS3-CAEFA105	5000 ± 50	197 ± 2
	ACS3-CAEFA110	10000 ± 100	394 ± 4
	ACS3-CAEFA120	20000 ± 100	787 ± 4

Ordering Information

Accessories

Encoder Cable (Incremental Type)

F100 - F180

A3/B3 motor, angular connector

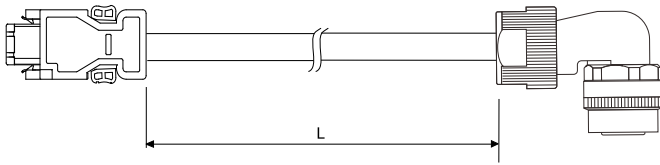

Cable	Model Name	L	
		mm	inch
Standard	ACS3-CREN0103	3000 ± 50	118 ± 2
	ACS3-CREN0105	5000 ± 50	197 ± 2
	ACS3-CREN0110	10000 ± 100	394 ± 4
	ACS3-CREN0120	20000 ± 100	787 ± 4
Torsion-Resistant	ACS3-CREF0103	3000 ± 50	118 ± 2
	ACS3-CREF0105	5000 ± 50	197 ± 2
	ACS3-CREF0110	10000 ± 100	394 ± 4
	ACS3-CREF0120	20000 ± 100	787 ± 4

Encoder Cable (Absolute Type)

F40 - F80

A3/B3 motor

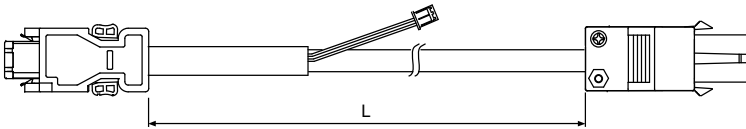

Cable	Model Name	L	
		mm	inch
Standard	ACS3-CAEA0103	3000 ± 50	118 ± 2
	ACS3-CAEA0105	5000 ± 50	197 ± 2
	ACS3-CAEA0110	10000 ± 100	394 ± 4
	ACS3-CAEA0120	20000 ± 100	787 ± 4
Torsion-Resistant	ACS3-CAEB0103	3000 ± 50	118 ± 2
	ACS3-CAEB0105	5000 ± 50	197 ± 2
	ACS3-CAEB0110	10000 ± 100	394 ± 4
	ACS3-CAEB0120	20000 ± 100	787 ± 4

F40 - F80

A3/B3 motor, IP67 waterproof connector

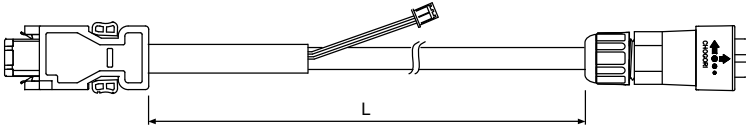

Cable	Model Name	L	
		mm	inch
Standard	ACS3-CAEA1103	3000 ± 50	118 ± 2
	ACS3-CAEA1105	5000 ± 50	197 ± 2
	ACS3-CAEA1110	10000 ± 100	394 ± 4
	ACS3-CAEA1120	20000 ± 100	787 ± 4
Torsion-Resistant	ACS3-CAEB1103	3000 ± 50	118 ± 2
	ACS3-CAEB1105	5000 ± 50	197 ± 2
	ACS3-CAEB1110	10000 ± 100	394 ± 4
	ACS3-CAEB1120	20000 ± 100	787 ± 4

F100 - F180

A3/B3 motor, straight connector

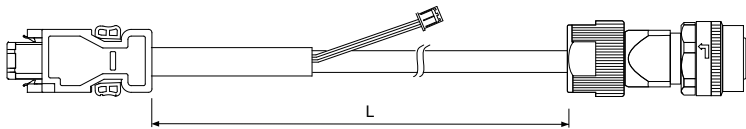

Cable	Model Name	L	
		mm	inch
Standard	ACS3-CAEAA103	3000 ± 50	118 ± 2
	ACS3-CAEAA105	5000 ± 50	197 ± 2
	ACS3-CAEAA110	10000 ± 100	394 ± 4
	ACS3-CAEAA120	20000 ± 100	787 ± 4
Torsion-Resistant	ACS3-CAEBA103	3000 ± 50	118 ± 2
	ACS3-CAEBA105	5000 ± 50	197 ± 2
	ACS3-CAEBA110	10000 ± 100	394 ± 4
	ACS3-CAEBA120	20000 ± 100	787 ± 4

F100 - F180

A3/B3 motor, angular connector

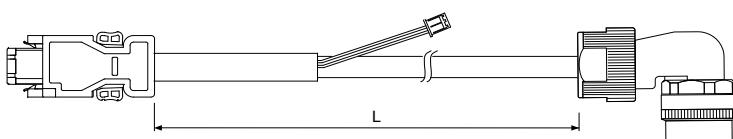

Cable	Model Name	L	
		mm	inch
Standard	ACS3-CREAA103	3000 ± 50	118 ± 2
	ACS3-CREAA105	5000 ± 50	197 ± 2
	ACS3-CREAA110	10000 ± 100	394 ± 4
	ACS3-CREAA120	20000 ± 100	787 ± 4
Torsion-Resistant	ACS3-CREBA103	3000 ± 50	118 ± 2
	ACS3-CREBA105	5000 ± 50	197 ± 2
	ACS3-CREBA110	10000 ± 100	394 ± 4
	ACS3-CREBA120	20000 ± 100	787 ± 4

Unit: mm(inch)

Absolute Battery Box

**Single Battery Box
ASD-MDBT0100**

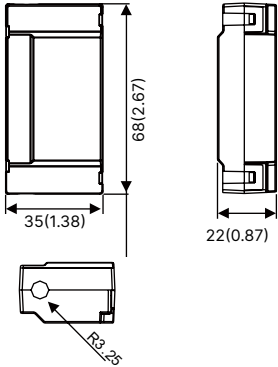

**Double Battery Box
ASD-MDBT0200**

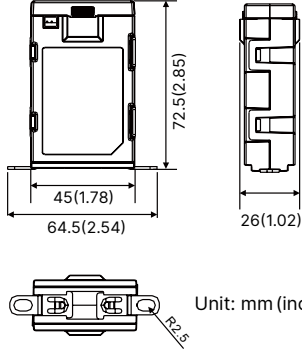

Unit: mm (inch)

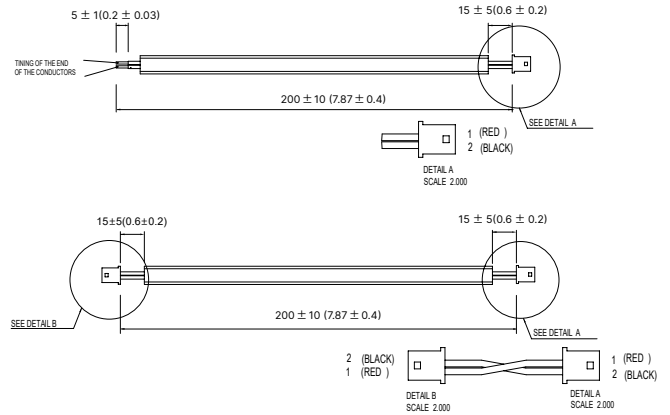

Note: Contact Delta Global Service team if ordering battery box cord only

CN1 Terminal Block Module

ACS3-MDTB4400 (for B3-L)

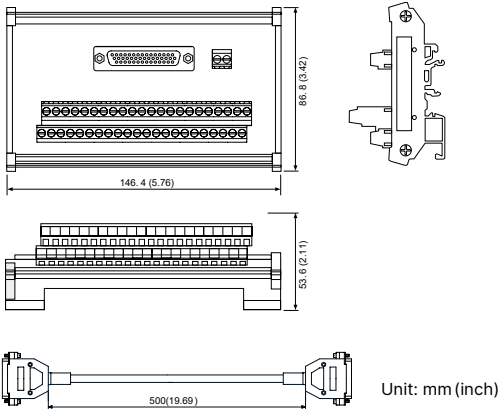

ACS3-MDTD2600 (for B3-M, F, and E)

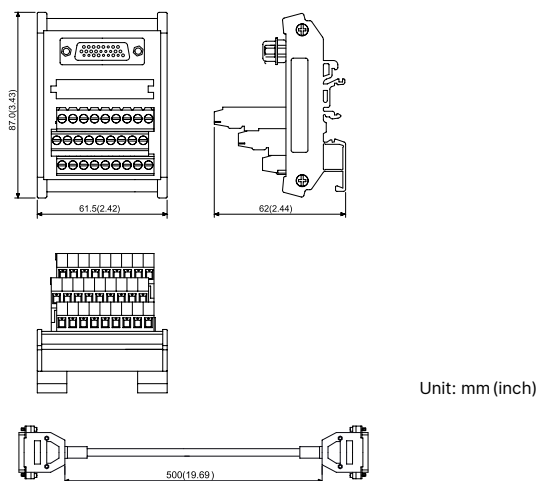

CN3 CANopen Communication Cable

UC-CMC030-01A, UC-CMC050-01A

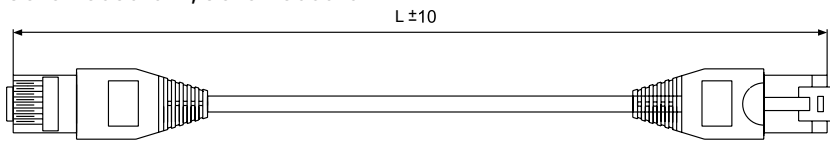

Item	Part No.	L	
		mm	inch
1	UC-CMC030-01A	3000 ± 10	11 ± 0.4
2	UC-CMC050-01A	5000 ± 10	19 ± 0.4

Ordering Information

Accessories

CN1 Connectors

ACS3-IFSC4444 (for B3-L)

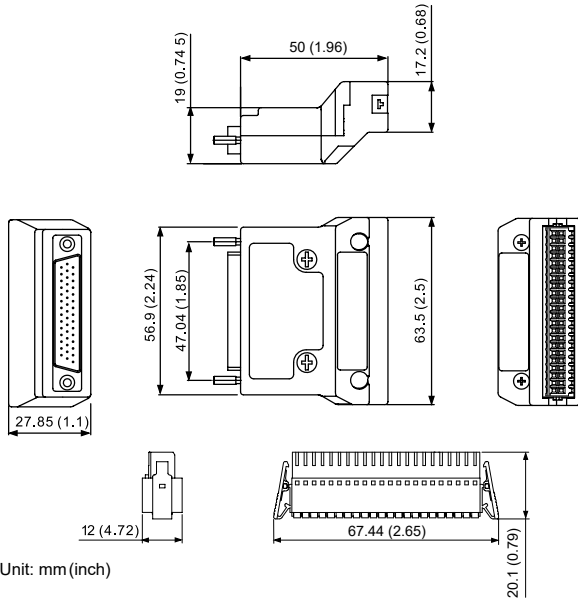

ACS3-IFSC2626 (for B3-M, F, and E)

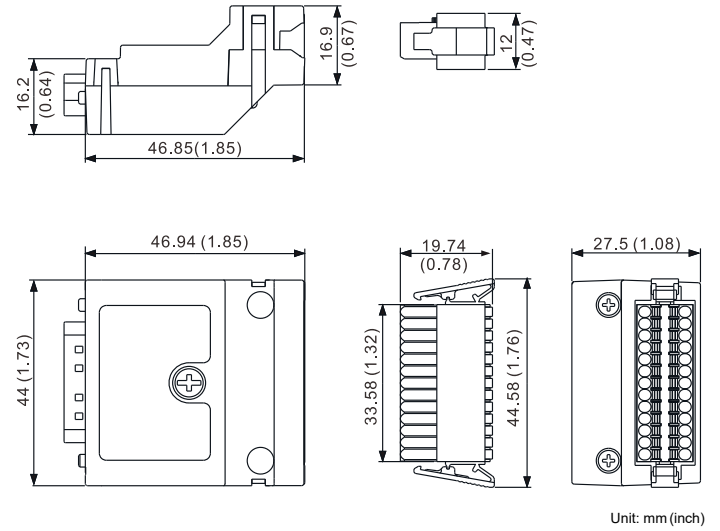

CN1 Connectors

ACS3-CNTB0400 (for B3-L)

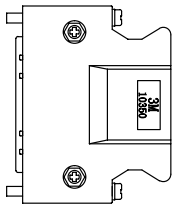

ACS3-CNTB0500 (for B3-M, F, and E)

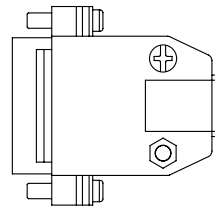

CN3 CANopen Distribution Box

TAP-CN03

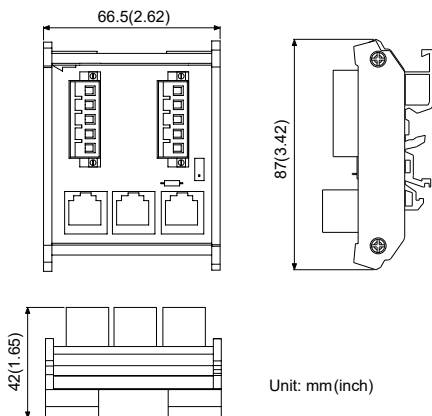

CN3 RS-485 Tap

ACS3-CNADC3RC

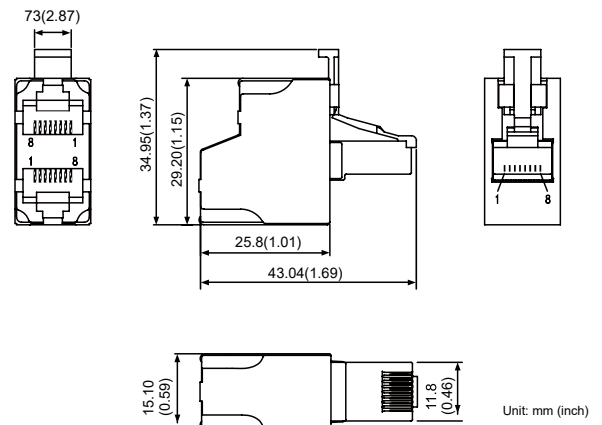

Ordering Information

Accessories

B3/B2 Conversion Cables

B3/B2 CN1 conversion cable (for B3-L)
ACS3-CABDC1

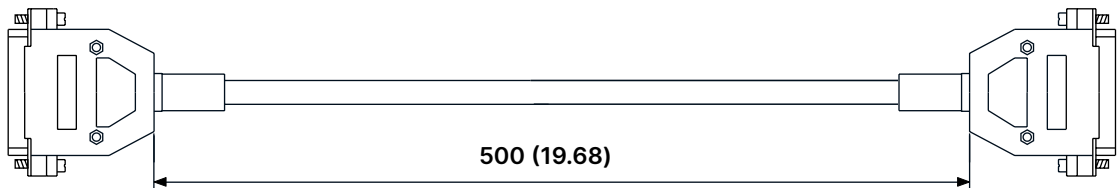

B3/B2 CN2 conversion cable
ACS3-CABDC2

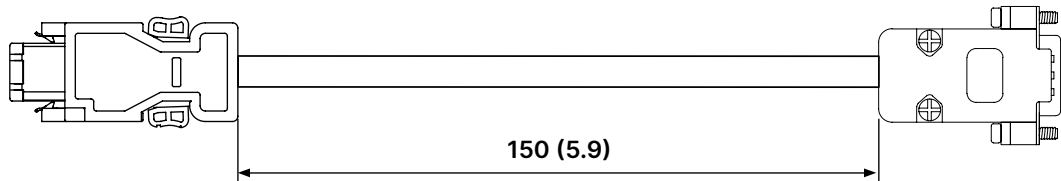

Unit: mm (inch)

CN3 RS-485/CANOpen Terminal Resistor

ACS3-CNADC3TR

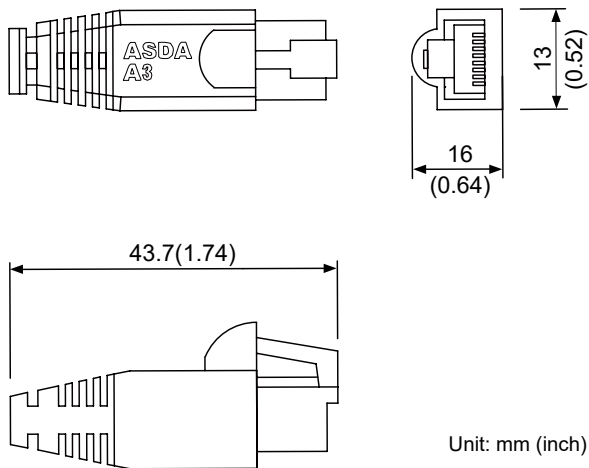

Unit: mm (inch)

CN6 DMCNET Terminal Resistor

ASD-TR-DM0008

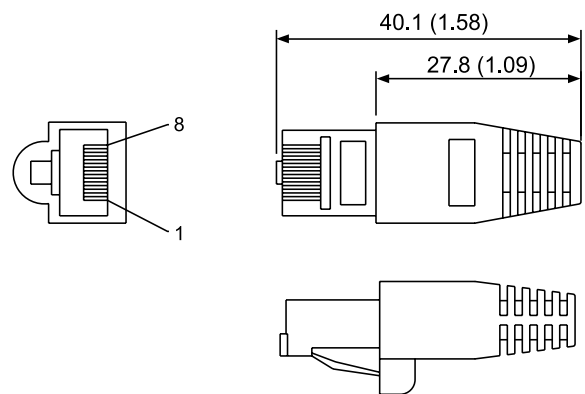

Unit: mm (inch)

Ordering Information

Accessories

CN4 Mini USB Communication Module

UC-PRG015-01B、UC-PRG030-01B

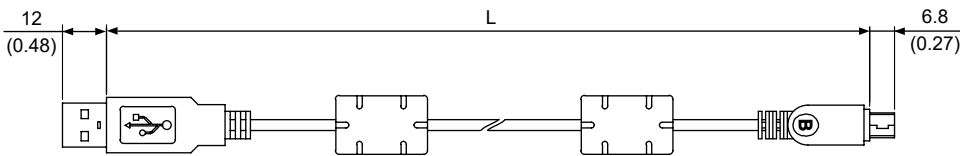
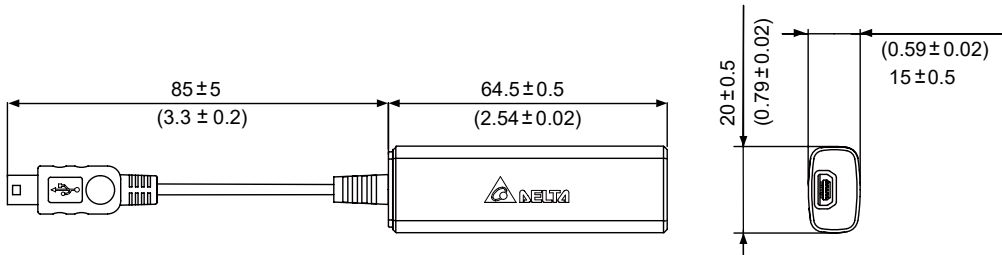

Unit: mm (inch)

Item	Part No.	L	
		mm	inch
1	UC-PRG015-01B	1500 ± 10	59 ± 4
2	UC-PRG030-01B	3000 ± 10	118 ± 4

CN4 Mini USB Communication Module

UC-ADP01-A

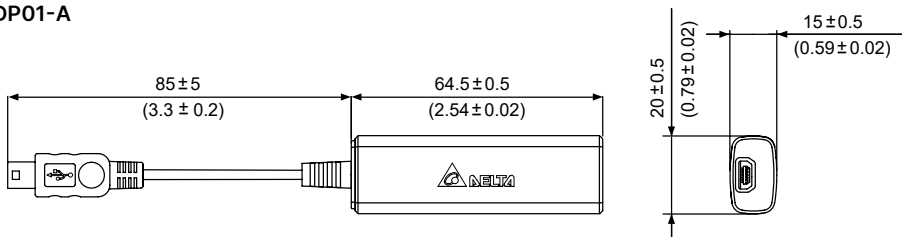

UC-PRG015-01A, UC-PRG030-01A

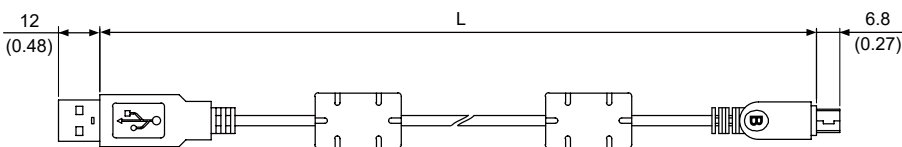

Unit: mm (inch)

Item	Part No.	L	
		mm	inch
1	UC-PRG015-01A	1500 ± 10	59 ± 4
2	UC-PRG030-01A	3000 ± 10	118 ± 4

Servo Drive Standards

Standard	ASD-B3 servo drive conforms to the highest standards and recommendations for electrical industrial control equipment (IEC, EN)
EMC Immunity	EN61000-4-6 Level 3
	EN61000-4-3 Level 3
	EN61000-4-2 Level 2 and 3
	EN61000-4-4 Level 3
	EN61000-4-8 Level 4
	EN61000-4-5 Level 3
Conducted and Radiated EMC Interference of Servo Drive	EN61800-3 Level 3, with external EMC filter
CE Marking	B3 series servo drives have the CE marking and conform to the European Union Low Voltage Directive (2014/35/EU) and EMC Directive (2014/30/EU)
Product Certification	UL (USA); cUL (CA) Note: B3 400V (with no UL)
STO	EN 61800-5-2:2007
	EN 61800-5-2:2017
	EN 61800-5-1:2007 + A1:2017, 4.3, 5.2.3.8, 5.2.6
	EN IEC 61800-3:2018
	EN 62061:2005 + AC:2010 + A1:2013 + A2:2015
	EN ISO 13849-1:2015
	EN 61508 Parts 1-7:2010
Protection Level	IEC/EN50178, IP20
Vibration Resistance Protection	20Hz and below (1G), 20 - 50Hz (0.6G), conforms to IEC/EN50178
Shock Resistance Protection	15gn 11ms; conforms to IEC/EN600028-2-27
Pollution Degree	Degree 2 conforms to IEC/EN61800-5-1



Smarter. Greener. Together.

Industrial Automation Headquarters

Taiwan: Delta Electronics, Inc.

Taoyuan Technology Center
No.18, Xinglong Rd., Taoyuan District,
Taoyuan City 33068, Taiwan
TEL: +886-3-362-6301 / FAX: +886-3-371-6301

Asia

China: Delta Electronics (Shanghai) Co., Ltd.

No.182 Minyu Rd., Pudong Shanghai, P.R.C.
Post code : 201209
TEL: +86-21-6872-3988 / FAX: +86-21-6872-3996
Customer Service: 400-820-9595

Japan: Delta Electronics (Japan), Inc.

Industrial Automation Sales Department
2-1-14 Shibadaimon, Minato-ku
Tokyo, Japan 105-0012
TEL: +81-3-5733-1155 / FAX: +81-3-5733-1255

Korea: Delta Electronics (Korea), Inc.

1511, 219, Gasan Digital 1-Ro., Geumcheon-gu,
Seoul, 08501 South Korea
TEL: +82-2-515-5305 / FAX: +82-2-515-5302

Singapore: Delta Energy Systems (Singapore) Pte Ltd.

4 Kaki Bukit Avenue 1, #05-04, Singapore 417939
TEL: +65-6747-5155 / FAX: +65-6744-9228

India: Delta Electronics (India) Pvt. Ltd.

Plot No.43, Sector 35, HSIIDC Gurgaon,
PIN 122001, Haryana, India
TEL: +91-124-4874900 / FAX: +91-124-4874945

Thailand: Delta Electronics (Thailand) PCL.

909 Soi 9, Moo 4, Bangpoo Industrial Estate (E.P.Z),
Pattana 1 Rd., T.Phraksa, A.Muang,
Samutprakarn 10280, Thailand
TEL: +66-2709-2800 / FAX: +66-2709-2827

Australia: Delta Electronics (Australia) Pty Ltd.

Unit 2, Building A, 18-24 Ricketts Road,
Mount Waverley, Victoria 3149 Australia
Mail: IA.au@deltaww.com
TEL: +61-1300-335-823 / +61-3-9543-3720

Americas

USA: Delta Electronics (Americas) Ltd.

5101 Davis Drive, Research Triangle Park, NC 27709, U.S.A.
TEL: +1-919-767-3813 / FAX: +1-919-767-3969

Brazil: Delta Electronics Brazil Ltd.

Estrada Velha Rio-São Paulo, 5300 Eugênio de
Melo - São José dos Campos CEP: 12247-004 - SP - Brazil
TEL: +55-12-3932-2300 / FAX: +55-12-3932-237

Mexico: Delta Electronics International Mexico S.A. de C.V.

Gustavo Baz No. 309 Edificio E PB 103
Colonia La Loma, CP 54060
Tlalnepantla, Estado de México
TEL: +52-55-3603-9200

EMEA

EMEA Headquarters: Delta Electronics (Netherlands) B.V.

Sales: Sales.IA.EMEA@deltaww.com
Marketing: Marketing.IA.EMEA@deltaww.com
Technical Support: iatechnicalsupport@deltaww.com
Customer Support: Customer-Support@deltaww.com
Service: Service.IA.emea@deltaww.com
TEL: +31(0)40 800 3900

BENELUX: Delta Electronics (Netherlands) B.V.

Automotive Campus 260, 5708 JZ Helmond, The Netherlands
Mail: Sales.IA.Benelux@deltaww.com
TEL: +31(0)40 800 3900

DACH: Delta Electronics (Netherlands) B.V.

Coesterweg 45, D-59494 Soest, Germany
Mail: Sales.IA.DACH@deltaww.com
TEL: +49 2921 987 238

France: Delta Electronics (France) S.A.

ZI du bois Challand 2, 15 rue des Pyrénées,
Lisses, 91090 Evry Cedex, France
Mail: Sales.IA.FR@deltaww.com
TEL: +33(0)1 69 77 82 60

Iberia: Delta Electronics Solutions (Spain) S.L.U

Ctra. De Villaverde a Vallecas, 265 1º Dcha Ed.
Hormigueras – P.I. de Vallecas 28031 Madrid
TEL: +34(0)91 223 74 20
Carrer Llacuna 166, 08018 Barcelona, Spain
Mail: Sales.IA.Iberia@deltaww.com

Italy: Delta Electronics (Italy) S.r.l.

Via Meda 2-22060 Novedrate(CO)
Piazza Grazioli 18 00186 Roma Italy
Mail: Sales.IA.Italy@deltaww.com
TEL: +39 039 8900365

Russia: Delta Energy System LLC

Vereyskaya Plaza II, office 112 Vereyskaya str.
17 121357 Moscow Russia
Mail: Sales.IA.RU@deltaww.com
TEL: +7 495 644 3240

Turkey: Delta Greentech Elektronik San. Ltd. Sti. (Turkey)

Şerifali Mah. Hendem Cad. Kule Sok. No:16-A
34775 Ümraniye – İstanbul
Mail: Sales.IA.Turkey@deltaww.com
TEL: + 90 216 499 9910

MEA: Eltek Dubai (Eltek MEA DMCC)

OFFICE 2504, 25th Floor, Saba Tower 1,
Jumeirah Lakes Towers, Dubai, UAE
Mail: Sales.IA.MEA@deltaww.com
TEL: +971(0)4 2690148

*We reserve the right to change the information in this catalogue without prior notice.