



Digitized Automation for a Changing World

Delta Compact Modular Mid-range PLC AS Series



www.deltaww.com



Flexible, Smart, Friendly - The Best Choice for a Controller of Automated Equipment

The AS Series Compact Modular Mid-range PLC is a high performance multi-purpose controller designed for all kinds of automated equipment. It features Delta's self-developed 32-bit SoC CPUs for enhanced execution speed (40k steps/ms) and supports up to 32 extension modules or up to 1,024 inputs/outputs. The AS series provides accurate positioning control for up to 8 axes via CANopen motion network and 6 axes via pulse control (200 kHz). It is widely used in diverse automated equipment such as for electronics manufacturing, labeling, food packaging, and textile machines.

The AS Series Controller is equipped with CANopen and EtherNet/IP network communication for high-speed data transmission. The professional yet simple editing software DIADesigner delivers quick hardware and network configuration with built-in function blocks for different industries. It also provides multi-layer password protection for enhanced system security.

The AS Series adopts a rackless design and DIN rail clips for fast vertical module installation. The simple shape and dark gray exterior of the AS series help resist stains and dirt in harsh industrial environments.





High Efficiency Computing

- Advanced CPU performance
- Optimized execution efficiency
- Optimized I/O update rate
- Permanent data backup, no battery required



Accurate Axis Control

- Delta CANopen positioning control
- Simple control instructions
- High-speed pulse positioning control
- High-speed counter



AS500 Motion Control Solution

- AS500 EtherCAT motion control system
- AS500 CANopen motion control system
- Higher scalability in DVP-MC & AS500
- Highly integrated CPU design



AX-3 CODESYS Control Solution

- AX-3 CODESYS control system
- Benefits of CODESYS platform
- Highly integrated CPU design



Simple Installation

- Easy installation process
- Convenient grounding protection
- Screwless installation procedure
- Loose-proof clip-type terminal block



Industrial Network Solution

- EtherNet/IP solution
- Remote I/O solution
- Serial communication solution

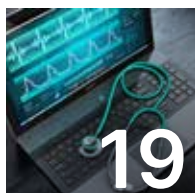

Programming & Diagnosis

- Modular programming structure
- Convenient editing environment
- Easy hardware configuration and parameter setting
- Complete setting tools
- Multiple password protection



Models and Specifications

- Model name explanation
- CPU
- AS Series I/O modules
- High-density modules and accessories
- Dimensions
- Ordering information

High Efficiency Computing

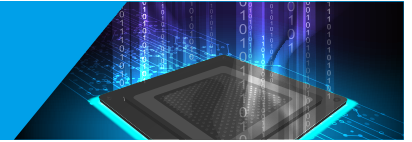

Delta's self-developed AS200 / AS300 Series CPU provides 32-bit high-performance computing and a real-time operation system. As the core of a high-efficiency controller, it helps increase the productivity and adaptability of demanding equipment.



Advanced CPU Performance

■ High Execution Speed

- Max. number of inputs/outputs: 1,024
- Max. extension ability: 32 modules

LD instruction of AS200 / 300 series CPU → 25 ns

LD instruction of AS500 series CPU → 50 ns

LD instruction of AX-3 series CPU → 5 ns



Optimized Execution Efficiency

General Scanning Method

Standard simplex scanning which sequentially goes through instructions by fixed schedule operation (e.g. I/O update). It significantly affects overall execution speed.

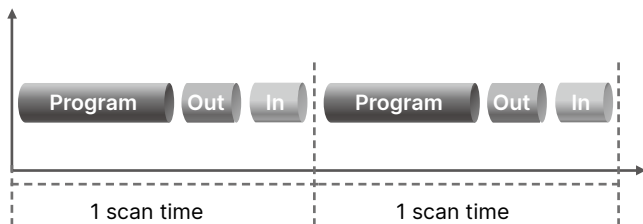

AS Series Scanning Method

Fixed schedule operations will be automatically processed by the CPU background program when scanning starts. This significantly enhances execution speed.

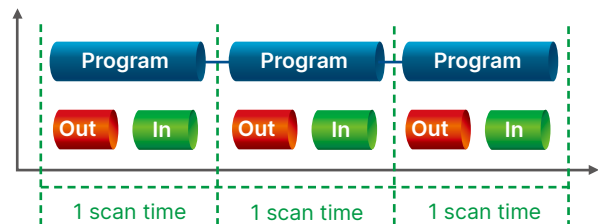

Optimized I/O updates

Common in the industry: PLC module bus update via serial communication

General serial communication: the signal is sequentially sent from the 1st module to the last module. The more modules the longer I/O update time it takes.

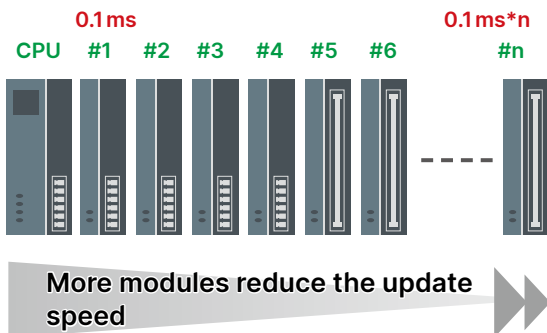

AS Series: PLC module bus update via optimized CAN protocol

CAN protocol: The signal is sent via optimized CAN bus protocol. The I/O update time is not significantly prolonged even with more modules.

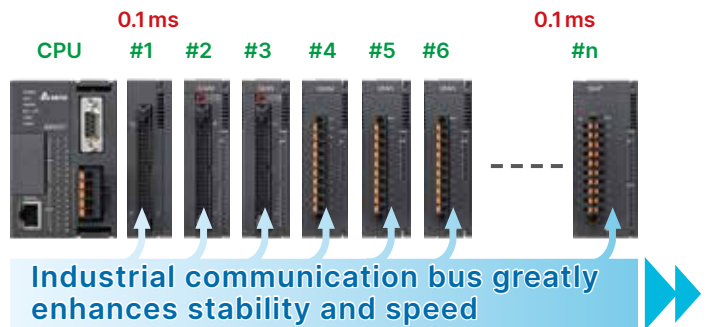

Note: The real updating performance will be different for different extension modules.

Permanent data backup, no battery required

Non-volatile memory material for data backup

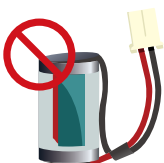

	PLC power off
PLC programs	permanent backup
Latched area	permanent backup

Lithium button battery for Real Time Clock (RTC) function



	PLC power off
RTC	keeps accurate time

Accurate Axis Control - Positioning Control Solution

AS200/300 CPU



CANopen DS301



Supports up to 8 Delta servo drives, 8 AC motor drives, and 7 AS RIO stations

AS200/300 positioning control - Delta's CANopen control

- AS200/300 supports up to 8 Delta servo drives and 8 AC motor drives (AS-FCOPM function card is needed for the AS300)
- Fast positioning configuration in one initialization instruction without building CANopen data exchange table
- Axis control by instructions provides easy maintenance and high PLC program readability

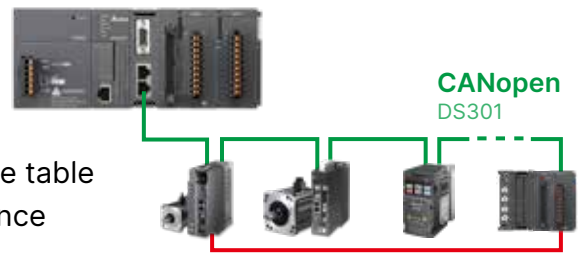

Supports up to 8 servo drives, 8 AC motor drives, and 7 AS RIO stations

Simple control instructions for Delta drives (AS200/300 series CPU only)

- Initialization: INITC
- Relative positioning: DRVIC (Servo only)
- Read and write parameter: COPRW
- Acceleration and deceleration: CASD
- Constant speed control: PLSVC
- Absolute positioning: DRVAC (Servo only)
- Start/Stop: ASDON
- Homing: ZRNC (Servo only)

ASDA-A2 back and forth motion control in 4 steps

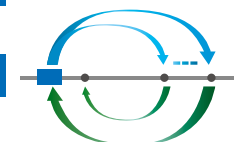
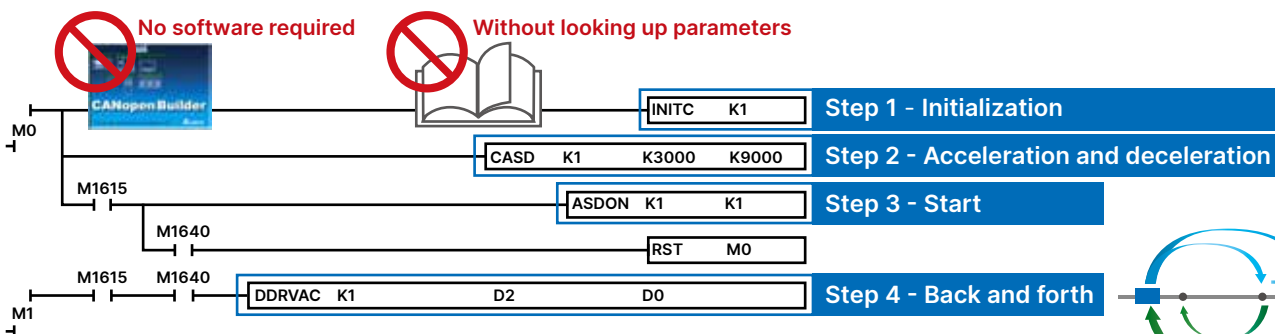

Dynamic modification of next speed and position.

Pulse 



Motion control of max. 6 Delta AC Servo Drives

■ Positioning control - high-speed pulse

- AS332T-A/AS332P-A transistor CPU: 6 axes (or 12 channels) 200 kHz
- AS324MT-A differential CPU: 2 axes 4 MHz + 4 axes 200kHz
- Supports positioning planning table for fast positioning planning and path simulation (AS200/300 series CPU only)
- Choose any given 2 axes for linear and arc interpolation

* Note: Please refer to the product specification section (P.28) for more information on CPU models

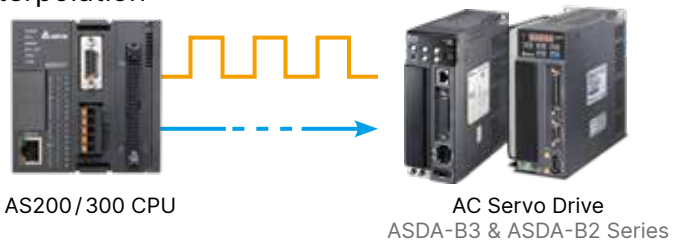

■ High-speed counter

- Real-time high precision monitoring:
AS332T-A/AS332P-A transistor CPU: 6 channels 200kHz
AS324MT-A differential CPU: 2 channels 4 MHz / 4 channels 200kHz
- Up to 16 external input interrupts
- High-speed counter setting tools

* Note: Please refer to the product specification section (P.28) for more information on CPU models

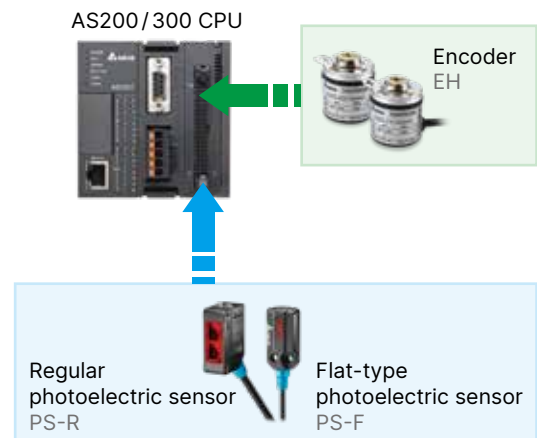
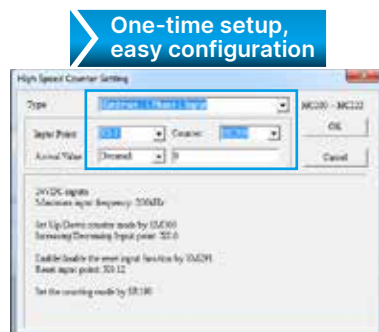

AS500 Motion Control Solution



AS500 EtherCAT motion control system

- AS516E CPU supports up to 16 Delta EtherCAT servos (min. sync time: 1 ms/16 axes)
- AS532ES/AS564ES CPUs support up to 32/64 Delta EtherCAT servos (Point-to-Point mode)
- Supports AS power, DIO, AIO, temperature and load cell expansion modules (max. 32 modules)
- 1GHz processor provides high operation performance
- Provides various motion commands: position, velocity, torque, multi-axis interpolation, E-gear, E-CAM, G-code, and more
- Built-in 16 DI & 8 DO, 2 incremental encoders, SSI absolute encoder, RS-232/485, Ethernet, CANopen DS301 and EtherCAT interfaces

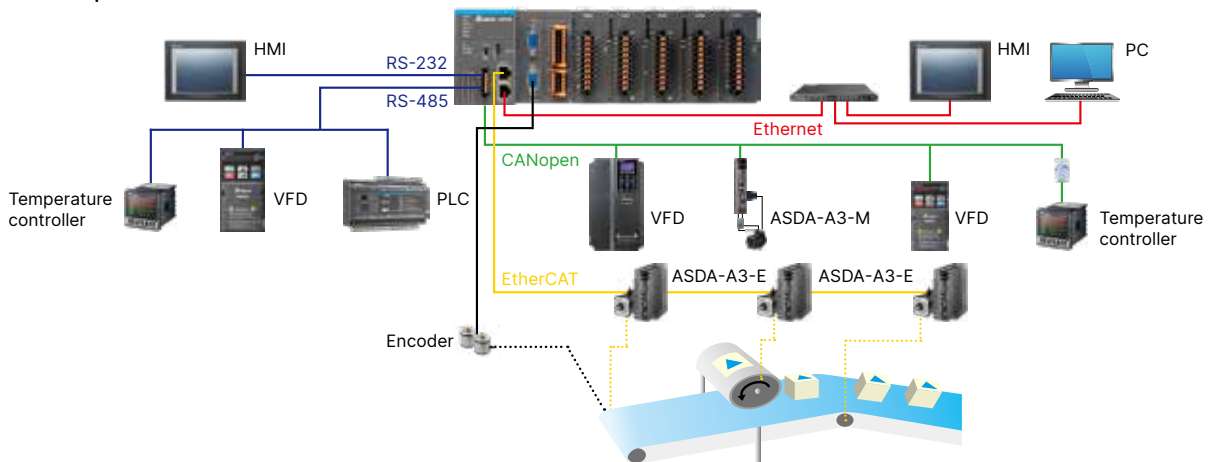

AS500 CANopen motion control system

- AS524C CPU supports up to 24 axes Delta CANopen servos (min. sync time: 2 ms/4 axes)
- Supports AS power, DIO, AIO, temperature and load cell expansion modules (max. 32 modules)
- 1GHz processor provides high operation performance
- Provides various motion commands: position, velocity, torque, multi-axis interpolation, E-gear, E-CAM, G-code, and more
- Built-in 16 DI & 8 DO, 2 incremental encoders, SSI absolute encoder, RS-232/485, Ethernet (x2), CANopen DS301 and CANopen motion interfaces

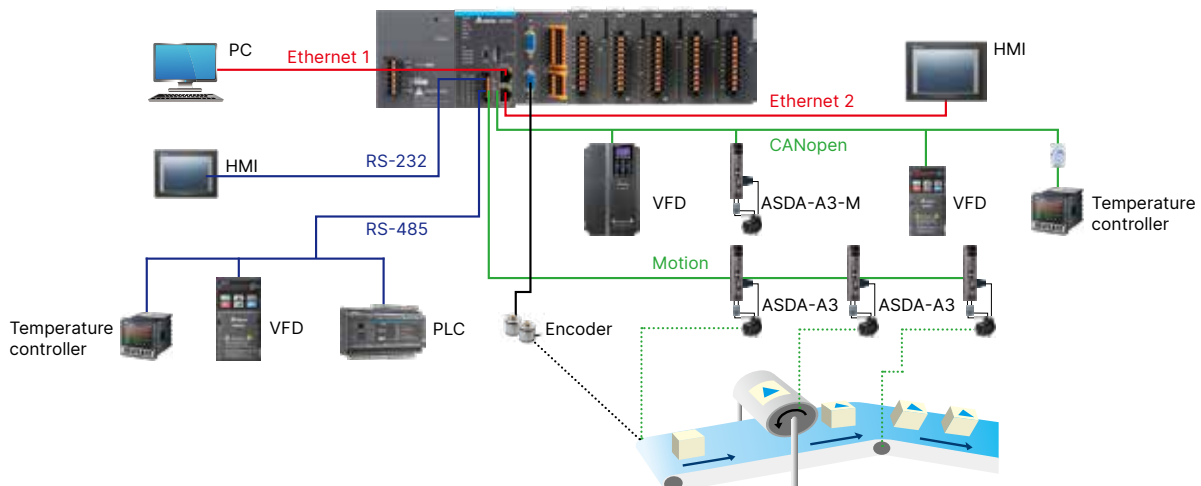

■ Higher scalability in DVP-MC and AS500

AS500 motion CPUs are designed with the Delta DVP-MC motion platform, which allows users to scale up/down their systems to AS/DVP systems without rewriting all programs

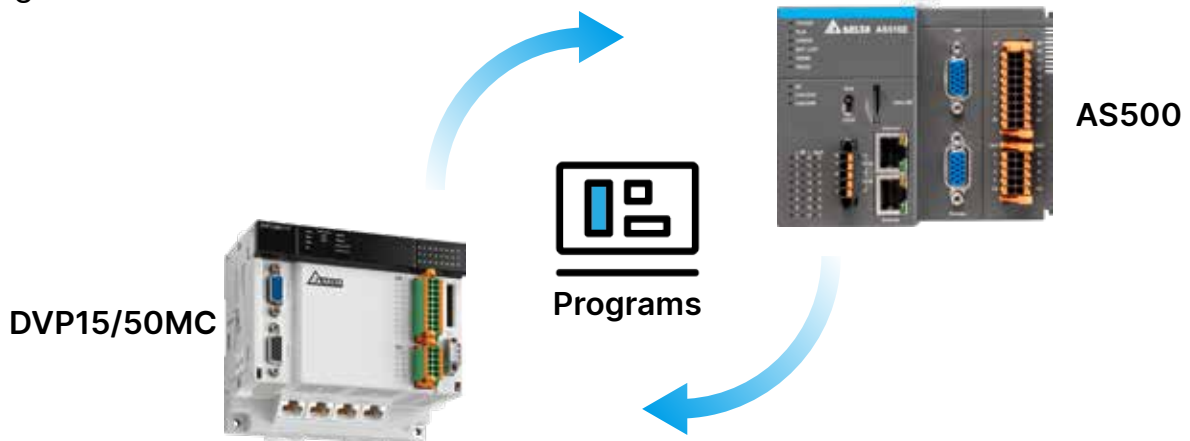

■ Highly integrated CPU design

The AS500 motion control CPUs feature various built-in I/O and communication protocols to satisfy customer needs for compact design and high performance

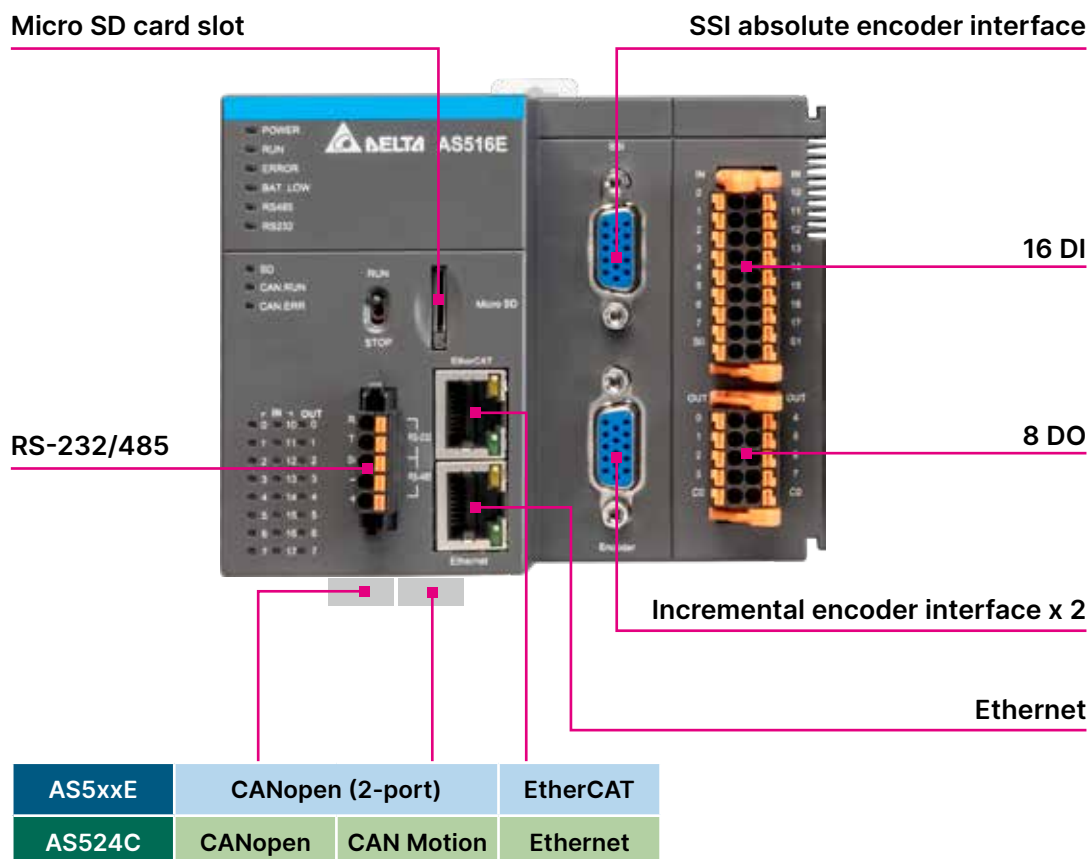

AX-3 CODESYS Control Solution



■ AX-3 CODESYS Control System

- Provides multiple controller solutions
 - EtherCAT motion controllers
 - AX-308E CPU supports up to 8 EtherCAT axes (min. sync time: 2 ms/8 axes)
 - AX-304EL/AX-364EL CPUs support up to 4/64 EtherCAT axes (Point-to-Point mode)
 - Logical controllers
 - AX-300N/AX-324N CPUs built-in 0/24 DIO points
- Supports AS power, DIO, AIO and temperature expansion modules (max. 32 modules)
- High performance, min. command execution time: 5 ns
- Provides various motion commands: position, velocity, torque, multi-axis interpolation, E-gear, E-CAM, and more
- Built-in 16 DI & 8 DO, 2 incremental encoders, SSI absolute encoder, RS-232/485, Ethernet and EtherCAT interfaces

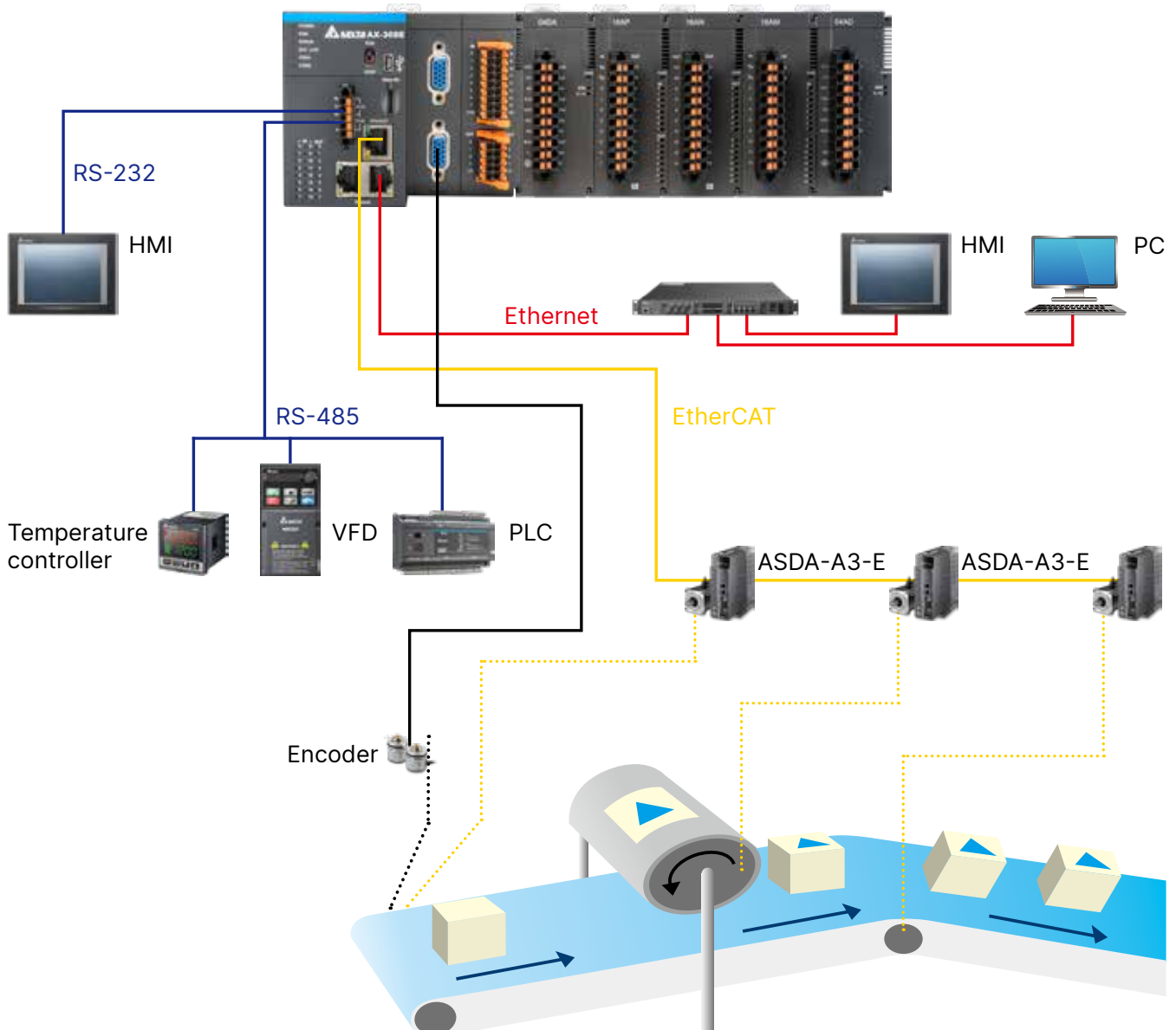

■ Benefits of CODESYS platform

- IEC61131-3 standards
- High performance and stable operation system
- Enhances project development efficiency with a standardized programming and controller development platform for parameter setting, configuration and PLCOpen editing

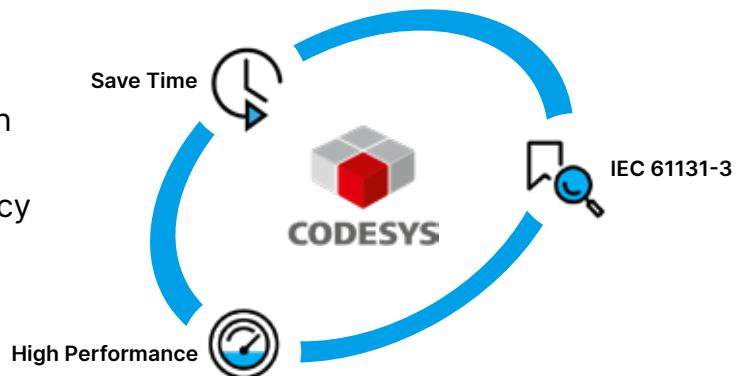

■ User-friendly programming software New

DIADesigner-AX is a new programming software for Delta AX series CPUs; it provides an optimized user-friendly programming environment and reduces programming time and effort for users

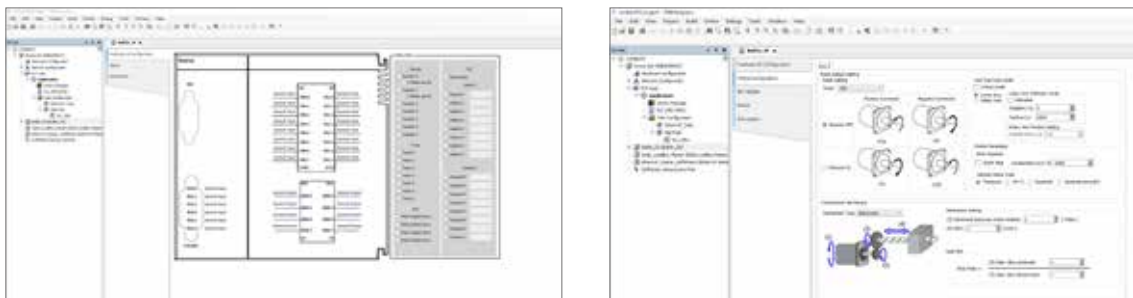

The user interface of built-in IO and axis parameter configuration

■ Highly integrated CPU design

The AX-3 motion control CPUs feature various built-in I/O and communication protocols to satisfy customer needs for compact design and high performance

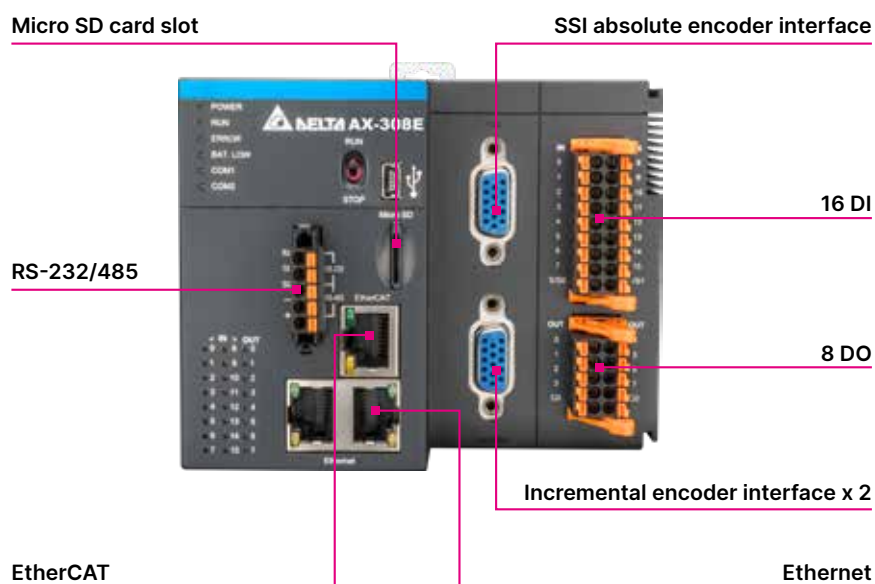

Simple Installation



■ Easy installation

- Space-saving design, suitable for installation in control panels

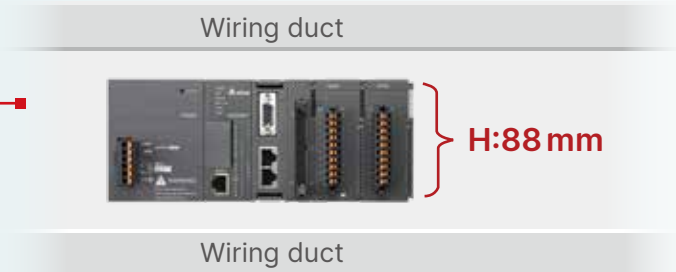
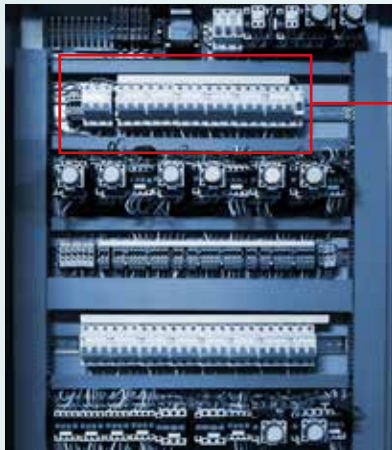

■ Rackless DIN-rail installation

▶ Robust slot and clip interlocking design

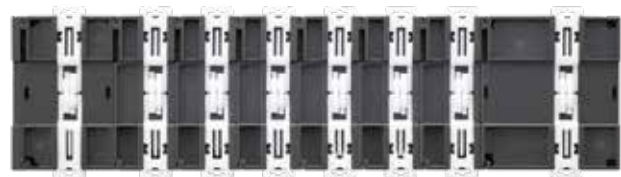

■ Fast disassembly

- Release the clip ring to easily take out the module from the front without moving adjacent modules



■ Simple installation process

- Press the clip rings and push the module to the desired position until you hear a "click" to finish installation

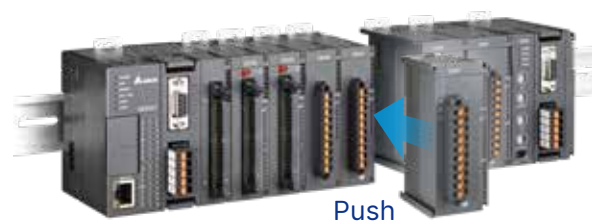

■ Convenient grounding protection

- DIN-rail installation: CPU module and expansion modules can be installed directly on DIN-rail without a backplane
- Installation with screws: pull out the installation clip ring and directly install it on the panel
- Both methods are equipped with ground protection

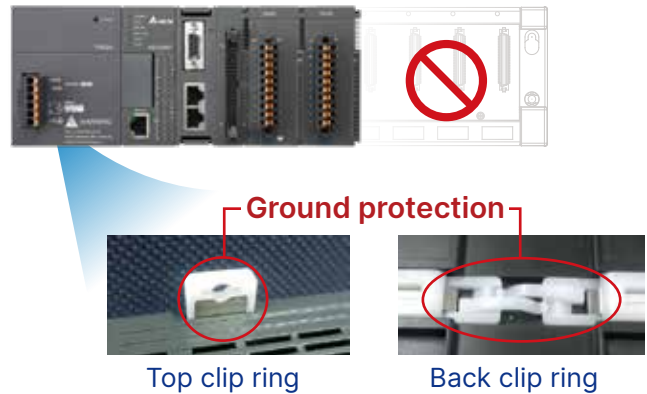

■ Screwless and time-saving installation

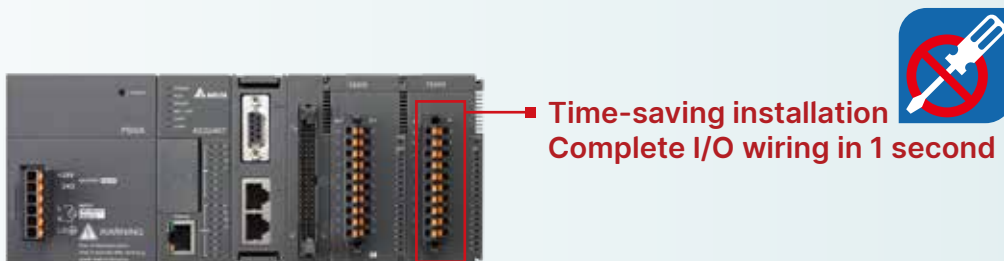

■ Robust loose-proof spring clamp terminal block

- In commonly used spring clamp terminal blocks, the clamping force is determined by the spring material, which decreases with the aging of the spring
- The AS Series adopts a full-covered spring clamp design that enhances the clamping force. When the wire is pulled-out (red arrow) and the spring moves up (green arrow), a downward force is generated (blue arrow) to clamp the wire.

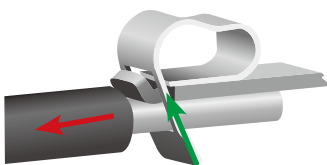

The green arrow is the clamping force, and the red arrow is the pull-out force.

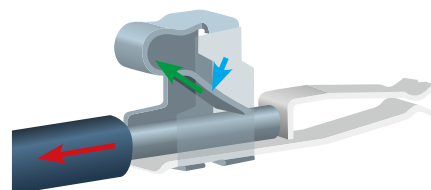

Industrial Network Solution

EtherNet/IP Solution

The open industrial Ethernet communication protocol for real-time control and data collection

EtherNet/IP

- Max. connection resource: 32
- Max. data transmission: 500 bytes/connection
- Performance: slave station data update in 1 scan time

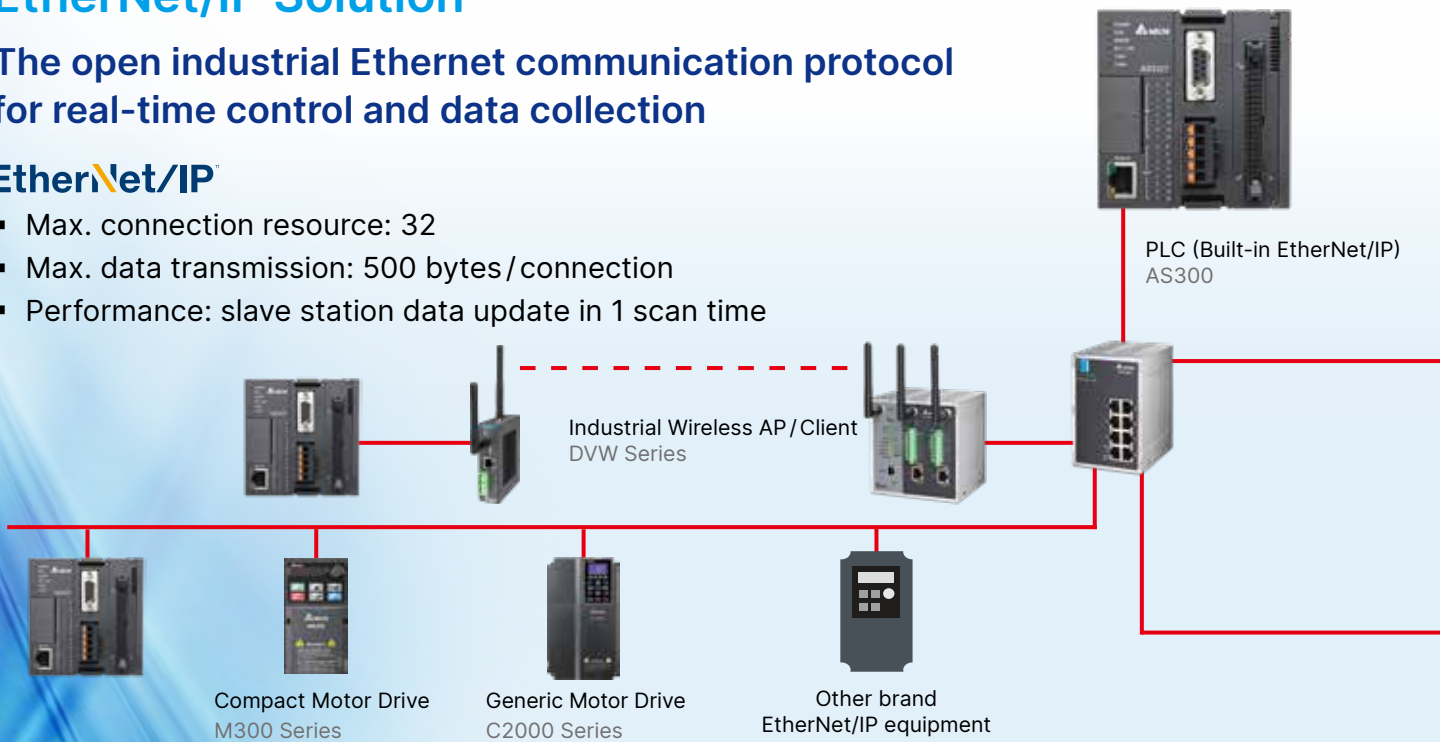

Flexible network system configuration

- Supports star, linear network topology for fast expansion and management on production lines
- Compatible with IT network, no independent network or IT technician required
- Combines with Delta IES solution to construct IoT for more automation applications and industrial 4.0 upgrades

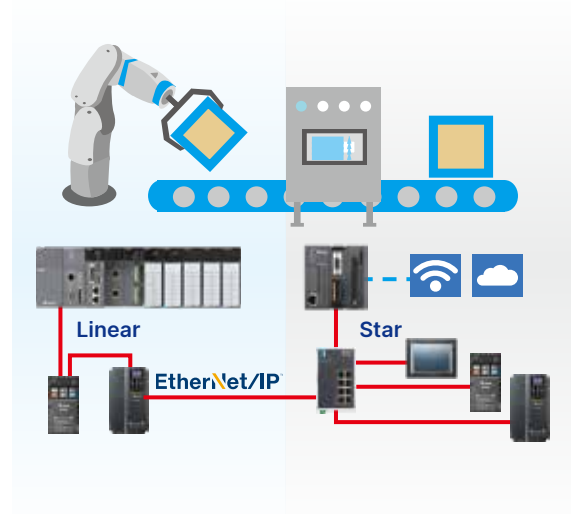

One cable, one network

- Complete Delta EtherNet/IP solution connects different equipment via Ethernet cable to simplify system networking
- Replaces traditional 3-layer industrial network structure with seamless connection via 100 MB high-speed network
- Complete industrial network diagnosis to shorten debug time

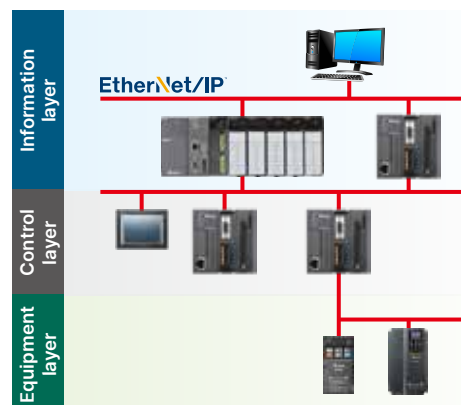

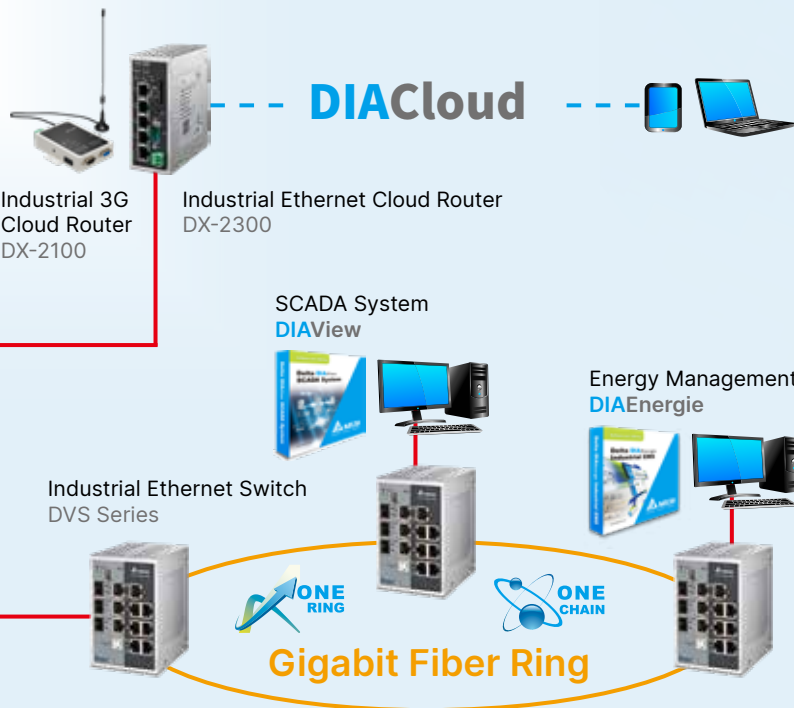

IoT & Industrial Ethernet

- DIACloud platform connection
- Redundancy ring recovery time < 20 ms
- Industrial class EMC testing

Software integration

- Consistent data exchange interface shortens learning time with fast system configuration
- Provides Delta's equipment parameter list for quick parameter matching without looking into a detailed manual
- EDS File provides quick connection with EtherNet/IP products of other brands

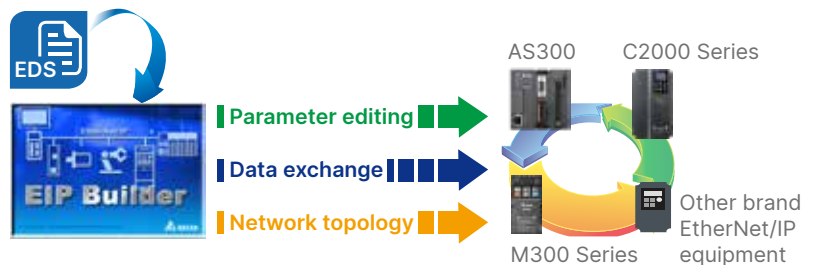

Accurate data update

- Provides real-time cyclic and acyclic data transmission and defines data priority between equipment
- Establishes multiple CIP links and defines different register priorities with one piece of equipment
- Executes data update based on user RPI. Updates all slave station data in one scan time
- Enhances stability by 70% compared to traditional Modbus TCP

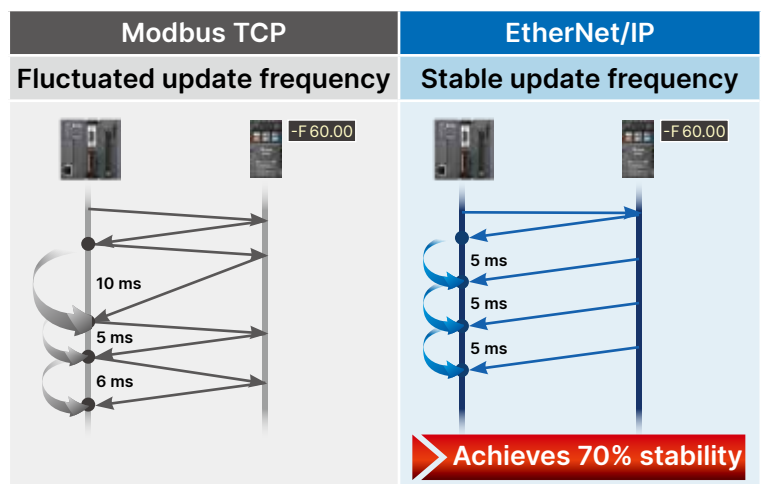

DIADesigner: EtherNet/IP

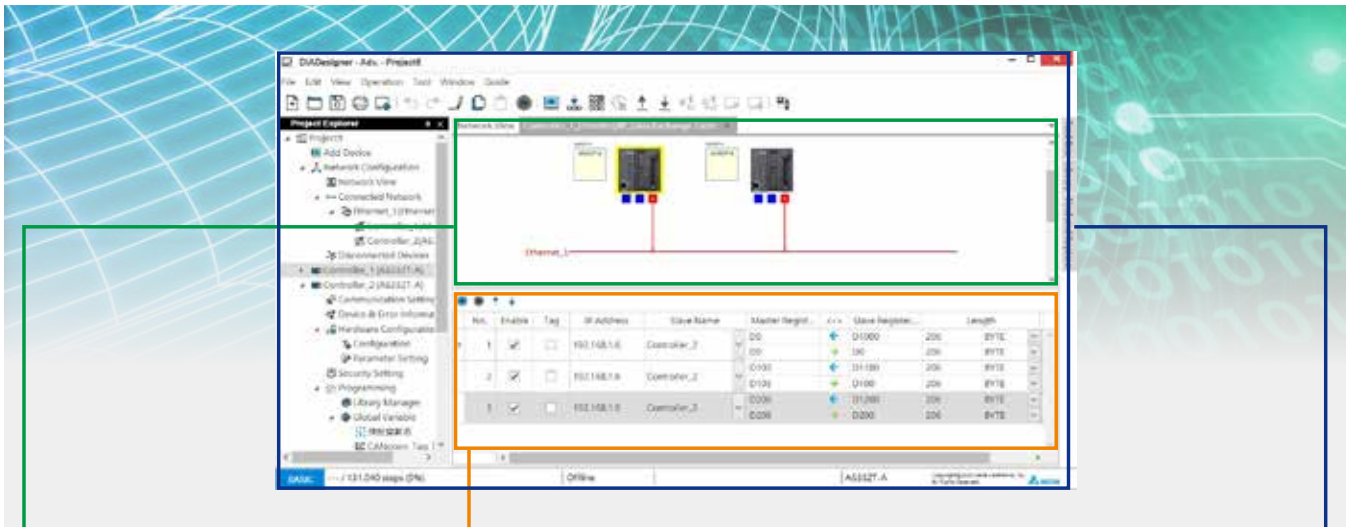

Visualized Network Mapping

- Direct network planning



Network Mapping Diagnosis

- Real-time network status and device indicators display



Parameter List

- Built-in parameter list of Delta's products

A screenshot of a parameter list table. The table has columns for 'No.', 'Name', 'Type', and 'Value'. It lists various Delta products and their associated parameters.

Data Exchange Table

- Data exchange via table blanks filling. PLC programming is not required

A screenshot of a data exchange table. The table has columns for 'No.', 'Enable', 'Tag', 'IP Address', 'Slave Name', 'Master Register', 'Slave Register', and 'Length'. It shows data for three different controllers.

Data Input/Output Corresponding Table

- Preset data exchange on corresponding parameters
- Connecting equipment editing on corresponding parameters

A screenshot of a data input/output corresponding table. The table has columns for 'No.', 'Name', 'Type', and 'Value'. It lists various parameters and their corresponding values.

Data Exchange Diagnosis

- Data exchange status and error codes

A screenshot of a data exchange diagnosis table. The table has columns for 'No.', 'Name', 'Type', and 'Value'. It lists various parameters and their corresponding values, including error codes.

Visualized Product List

- Visualized equipment selection



Equipment Description Management Function



AS200 / 300 Remote I/O Solution

- ### CANopen Remote I/O
- Max quantity of RIO stations: 15 stations
 - Max quantity of IO modules (CPU right side + RIO (SCM) right side): 32 modules
 - Max DIO points: 1,024 points
 - Max quantity of AIO modules: 16 modules
 - Max quantity of communication modules: 4 modules (Only installed on CPU right side)
 - Max quantity of IO modules installed on RIO (SCM) right side: 8 modules
 - AS-FCOPM can only be installed in slot 2 of the CPU and SCM
 - When a CPU is installed as AS-FCOPM in slot 2, then slot 1 can be used to install another function card except AS-FCOPM
 - When SCM is working in RIO (RTU) mode, then slot 1 is disabled

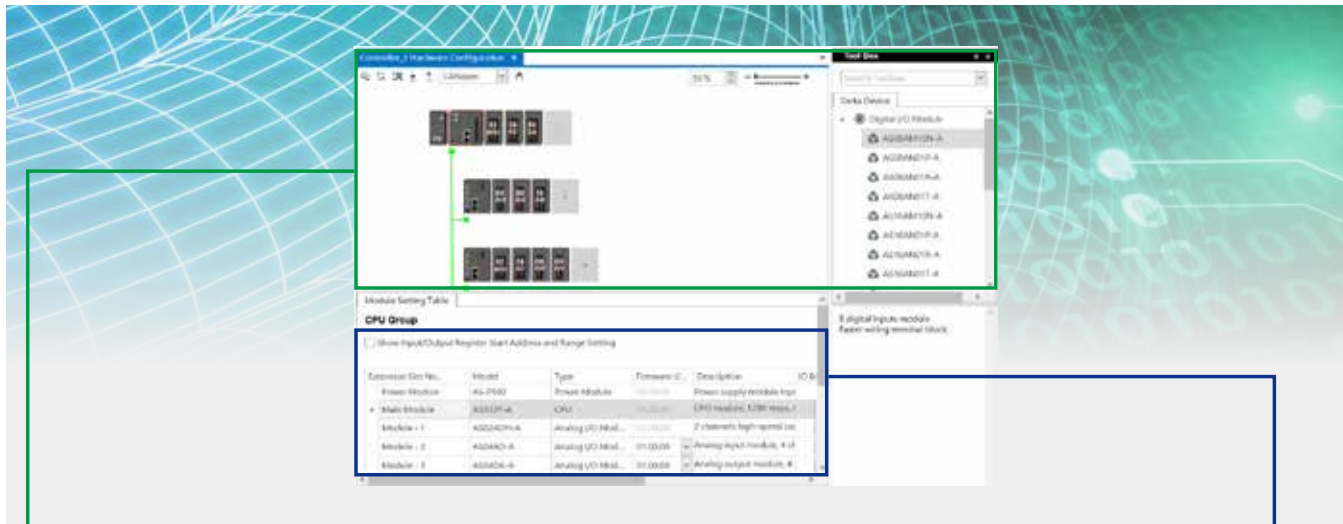
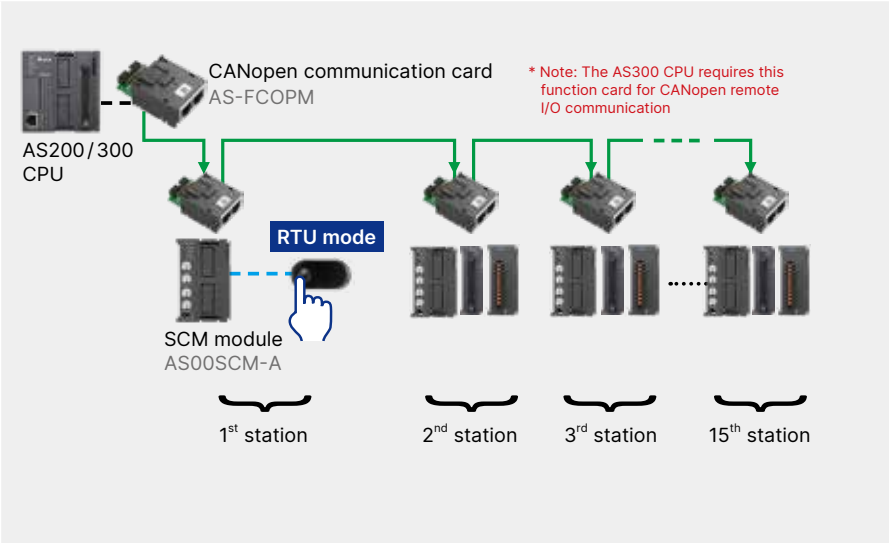

- **Hardware Configuration**
 - Hardware parameter complete planning
- **Visualized I/O Structure**
 - Direct I/O planning
- **I/O Product List**
 - Product description and specification

I/O without Planning

- Auto-mapping with I/O addresses in CPU (X, Y, and D)

Module	Type	Name	Start Address Range	End Address Range	Comment
Power Module	Power Module	AS-PS00	20000	20000	
Main Module	CPU	AS100-A	20000	20000	
Module - 1	Analog I/O Mod.	AS00SCM-A	20000	20000	
Module - 2	Analog I/O Mod.	AS00SCM-A	20000	20000	
Module - 3	Analog I/O Mod.	AS00SCM-A	20000	20000	

Module	Type	Name	Start Address Range	End Address Range	Comment
Power Module	Power Module	AS-PS00	20000	20000	
Main Module	CPU	AS100-A	20000	20000	
Module - 1	Analog I/O Mod.	AS00SCM-A	20000	20000	
Module - 2	Analog I/O Mod.	AS00SCM-A	20000	20000	
Module - 3	Analog I/O Mod.	AS00SCM-A	20000	20000	

Serial Communication Solution

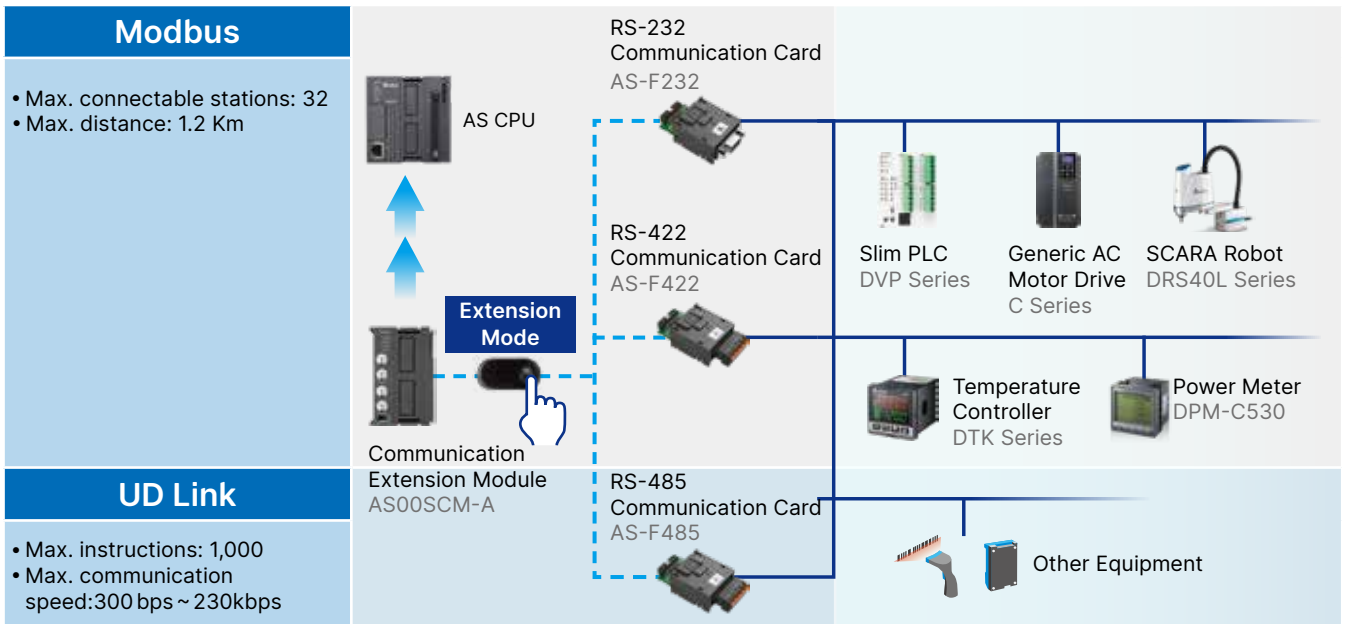

■ Modbus Mode

- Easy data exchange configuration

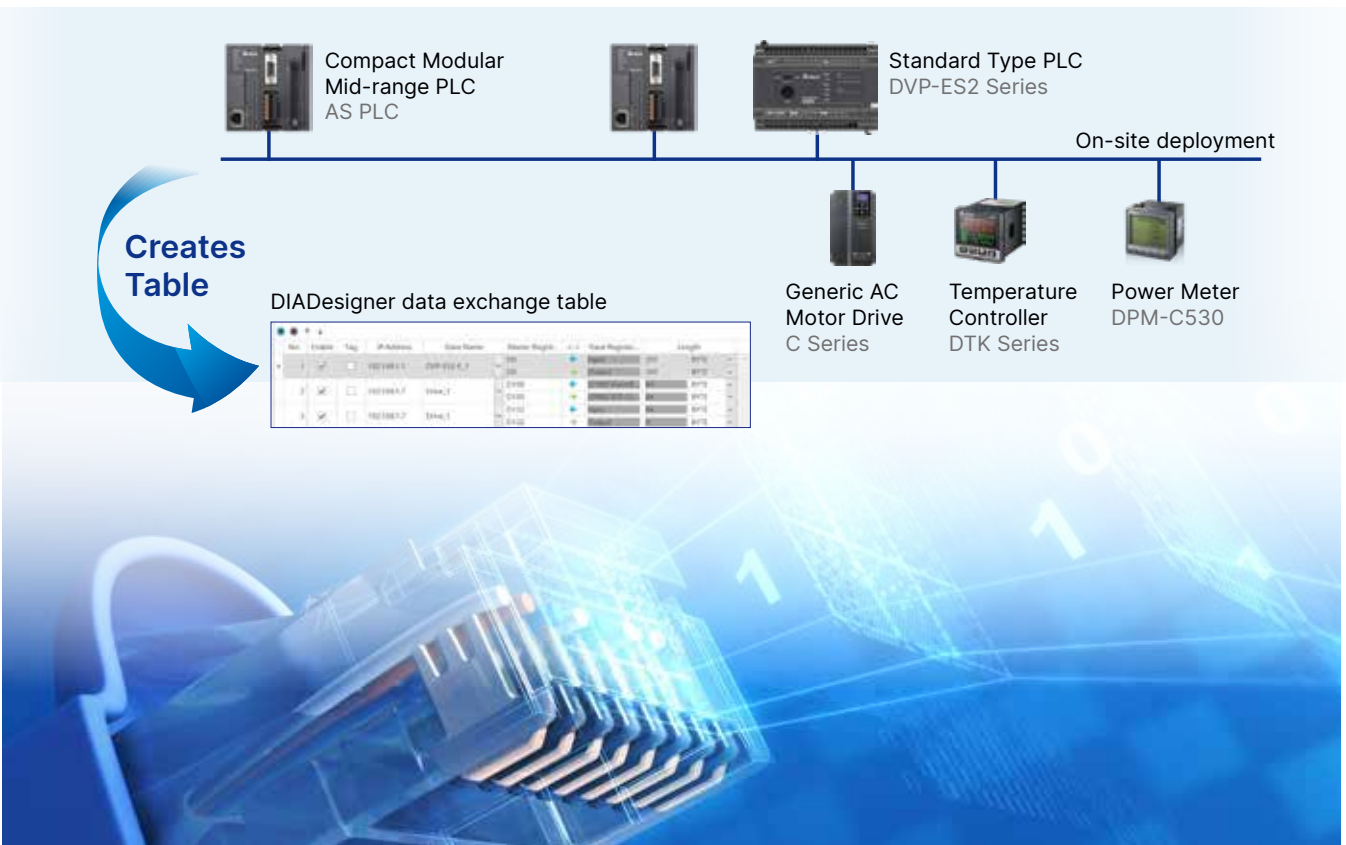

Real-time history log diagnosis

- AS00SCM stores 2k bytes history log; SCMSoft directly displays the log for real-time communication status monitoring with no additional monitoring software required

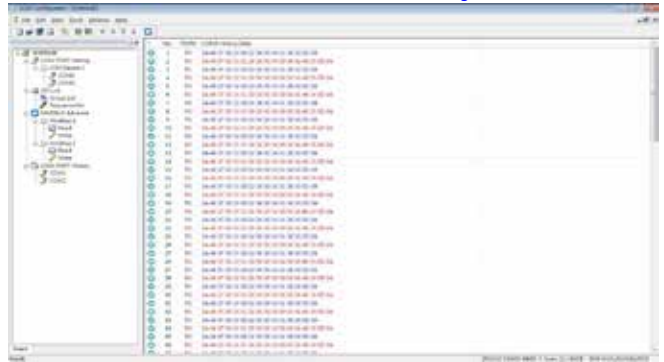

UD Link Mode (User-defined)

- Easy connection to end equipment via special communication protocols

Traditional programming structure

Instruction receiving, accessing, editing, transmitting, sequence control

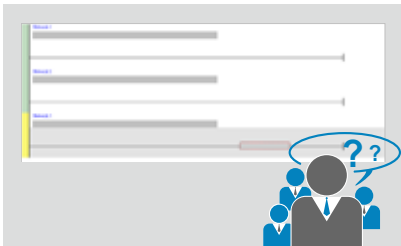

Connection to end equipment via special communication protocols

- Edits the transmitting/receiving packets via SCMSoft; format exchange and checksum calculation via AS00SCM
- Packet content auto-combination for logic control in PLC, reducing PLC program complexity
- Max. 1,000 transmitting/receiving packets

Packet No.	RX Packet Name
1	RX Packet1
2	RX Packet2
3	RX Packet3

Packet No.	TX Packet Name
1	TX Packet1
2	TX Packet2
3	TX Packet3

Packet Segment Edit

No.	Class	Format	Segment View
1	Message Constant	ASCII	"abcd"
2	Address Variable	Null	(R/D Register [4]), 4)
3	Message Constant	ASCII	"efgh"

Command execution sequence planning

Command No.	Command Type	Send Packet	Recv Packet	Success	Fail	Retry	Repeat	Send Wait
1	Send & Receive	TX Packet1	RX Packet1	Goto : 1	Goto : 1	0	2	0
2	Send & Receive	TX Packet2	RX Packet2	Goto : 2	Goto : 1	0	3	0
3	Send & Receive	TX Packet25	RX Packet3	Goto : 3	Goto : 1	0	4	0
4	Send & Receive	TX Packet25	RX Packet4	Goto : 4	Goto : 1	0	5	0
5	Send & Receive	TX Packet28	RX Packet5	Goto : 5	Goto : 1	0	6	0

User-defined communication format editing

Programming & Diagnosis

DIADesigner IEC Programming Software

Easy operation greatly enhances efficiency

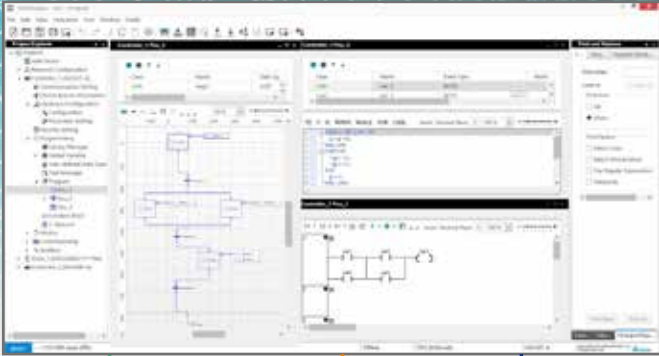

Data Tracer / Logger

- Data log and time-sequential analysis

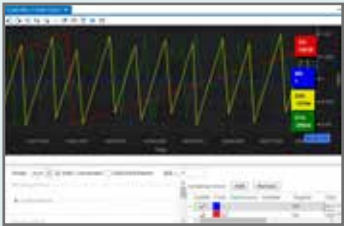

Positioning Planning Tool

- Table-structured position planning

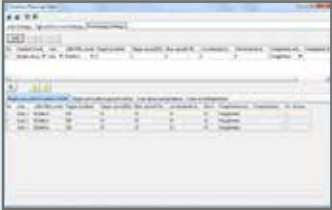

Projects for Multiple Devices

- Integrates multiple Delta products in one project

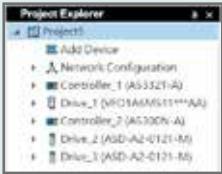

COMMGR

- Communication interface manager



AS200/300 CPU



Hardware Configuration

- Hardware configuration and parameter setting



Network Configuration

- Integrates fieldbus systems in one view, including EtherNet/IP, CANopen and Modbus

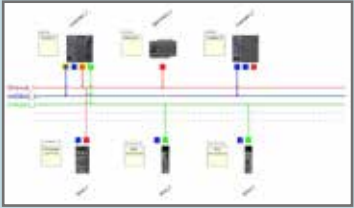

Modular Program Structure

Traditional program structure

Errors are often found in large-scale programs under a traditional structure and are hard to debug while increasing maintenance cost

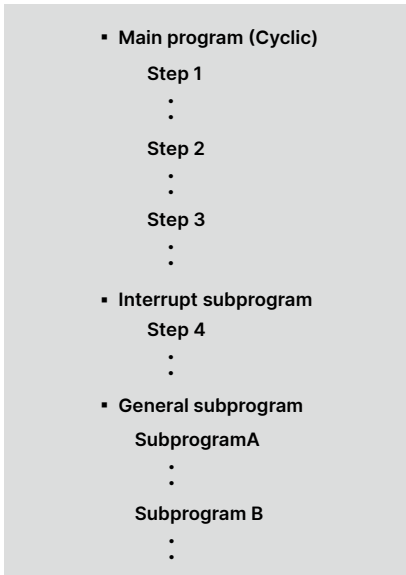

Modular program structure

Programming organization unit (POU) enables easy management in large-scale programs with high development efficiency

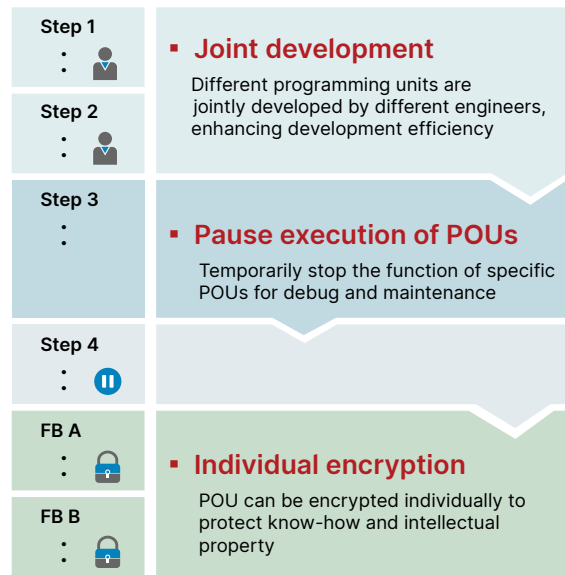

Modular Program Structure

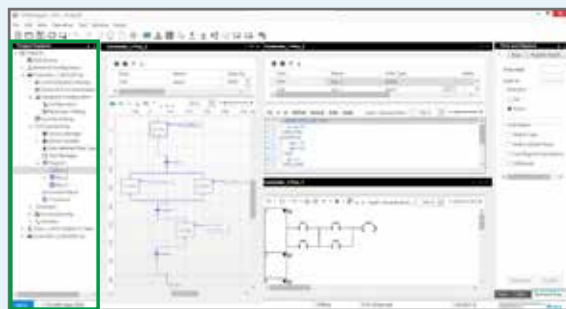

Interface display of task manager

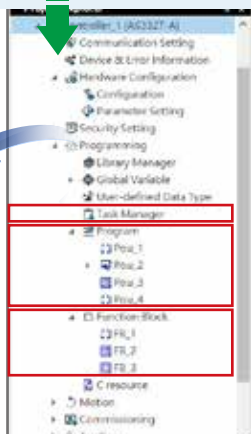

- **Task manager**
Plans the execution sequence of POU's and defines the nature of the tasks (cyclical or interruptive)
- **POU management**
Manages all POU's via a project tree and supports POU import/export for joint development or other uses
- **User library**
Various built-in Delta-developed FB's for users to choose and add to their library for quick use

Note: Actual support functions will vary by series

Convenient Programming

- **User-defined data type**

In addition to basic data types, users can define structures and enumerations for flexible programming

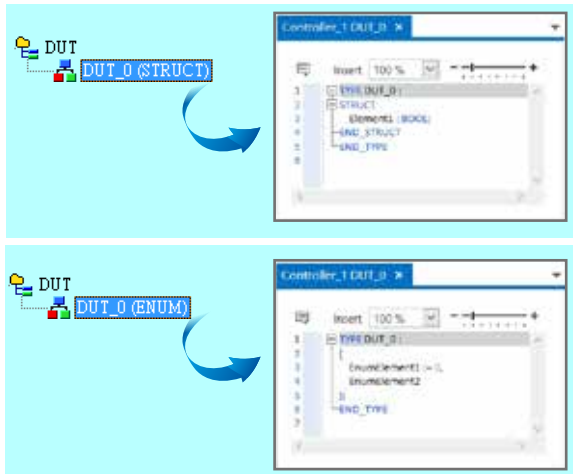

- **On-line programming/update**

Supports program editing in monitoring mode and program updates during equipment operation for convenient debugging and maintenance



- **Debugging mode**

Supports breakpoints, single step execution and other functions to enhance debugging efficiency

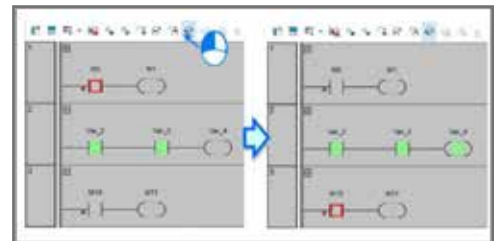

Multiple Programming Languages

- **Supports multiple programming languages in the same project**

- **Ladder Diagram (LD)**

DIADesigner provides a programming interface with the widely used LD language for faster programming

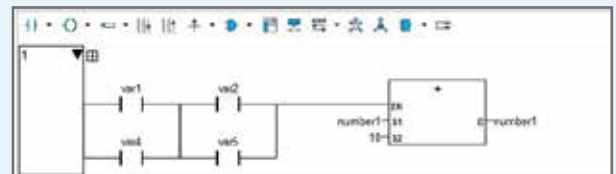

- **Structured Text (ST), C Language**

Similar programming method to advanced programming language. It provides more convenient editing for complicated expression



- **Sequential Function Chart (SFC)**

Direct and easy expression for the steps in flow charts, suitable for applications that require process control



Note: Actual support functions will vary by series

Easy Hardware Configuration and Parameter Setting

Hardware Configuration

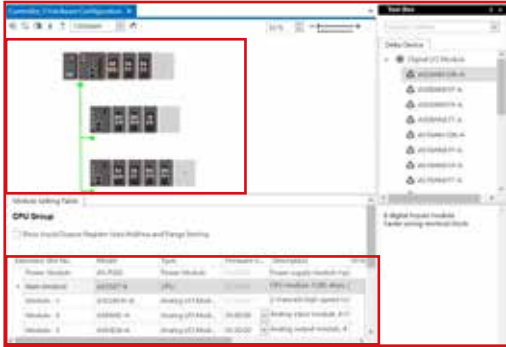

- **Graphic panel for module configuration**

Quick setup with automatic configuration imported by barcode scanning

- **I/O listing**

Direct display for corresponding device addresses after configuration



- **Parameter setting**

Fast parameter setting on controller and modules without manual reference or programming

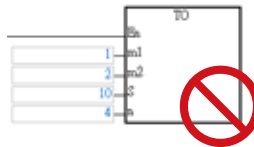

Note: Fill the table to configure module parameters quickly. From/To instruction is not required for module initialization.

- **Module configuration method**

- **Smart module configuration**

Supports an advanced planning tool for a variety of network modules

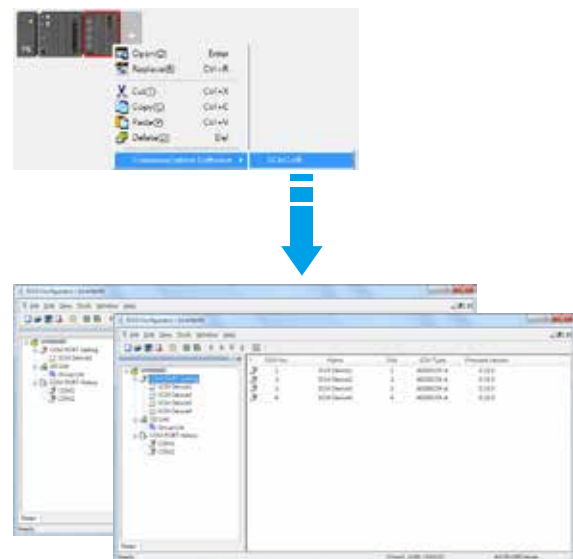
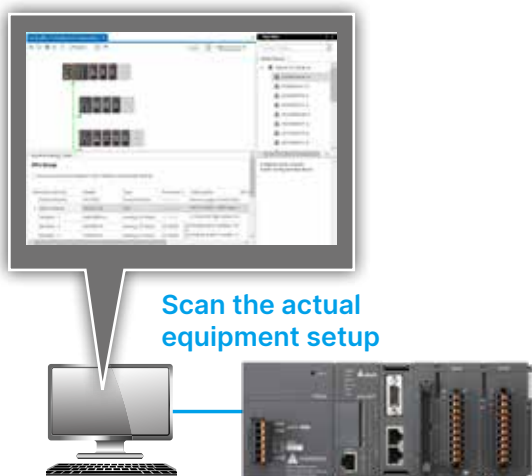

Note: Actual support functions will vary by series

Complete Diagnosis Tools for Quick and Effective System Monitoring

Data Logger / Tracer

- **Real-time monitoring:**
High-speed tracer for fast sampling within 1 scanning cycle
- **Stable logging:**
Long-time data logger savings of up to 32,768 data records, which can be transferred to SD card
- **Precise data acquisition:**
Supports a variety of sampling intervals and trigger modes
- **Convenient comparison:**
Multiple data logs in various data formats can be recorded at the same time for comparison
- **Efficient data analysis:**
Supports trend display, scaling, arrangement, merge and measurement

- Real-time
- Stable
- Precise

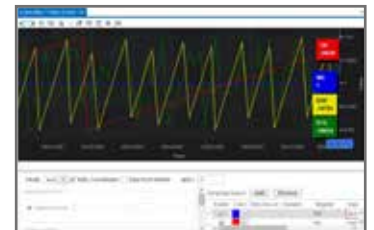

Real-time Module Monitoring

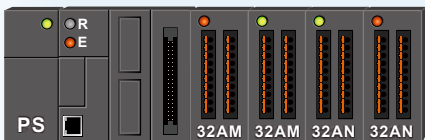

- **Visualized monitoring**
Direct monitoring interface provides real-time status on modules via LED indicators
- **Module comparison**
Real-time inspection of actual module settings to ensure consistency
- **Error logs**
Immediate inquiry for error messages and logs of anomalies
- **Module information**
Provides model name and version of current modules

Date/Time	Device No.	Module	Model Name	Version	Type & Time	Name
2013-01-28 10:00:00	0000	32AM	32AM	1.00	Power supply error	Power supply error
2013-01-28 10:00:01	0000	32AM	32AM	1.00	Power supply error	Power supply error
2013-01-28 10:00:02	0000	32AM	32AM	1.00	Power supply error	Power supply error
2013-01-28 10:00:03	0000	32AM	32AM	1.00	Power supply error	Power supply error
2013-01-28 10:00:04	0000	32AM	32AM	1.00	Power supply error	Power supply error
2013-01-28 10:00:05	0000	32AM	32AM	1.00	Power supply error	Power supply error
2013-01-28 10:00:06	0000	32AM	32AM	1.00	Power supply error	Power supply error
2013-01-28 10:00:07	0000	32AM	32AM	1.00	Power supply error	Power supply error
2013-01-28 10:00:08	0000	32AM	32AM	1.00	Power supply error	Power supply error
2013-01-28 10:00:09	0000	32AM	32AM	1.00	Power supply error	Power supply error
2013-01-28 10:00:10	0000	32AM	32AM	1.00	Power supply error	Power supply error

Note: Actual support functions will vary by series

Convenient Software Wizards for Effortless Planning

(AS200 / 300 series only)

Positioning planning table

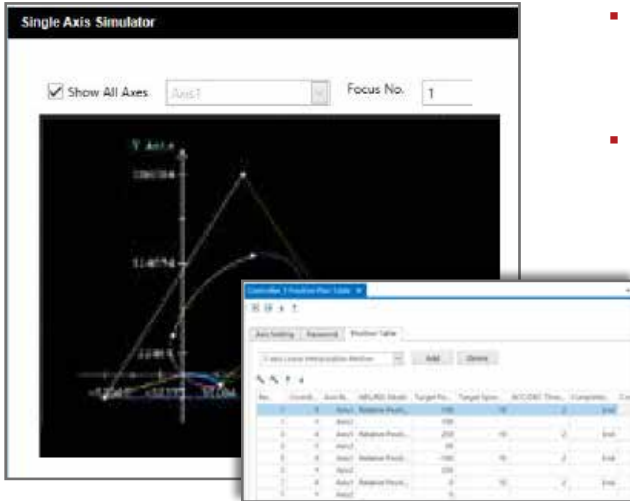

- **2D simulation**
Intuitive 2D track simulation without complicated calculation for real-time path planning
- **Path list**
Multiple combinations for positioning modes and tracks; fast path planning via table-structured planning
- **Axis parameter setting**
Intuitive configuration interface for easy axis parameter setting without manual reference

High-speed counter setting tool

- Counter index will display corresponding contact point, device and counter specification under counting mode
- Fast planning without manual reference for enhanced development efficiency



Multiple devices in one project

Integrates multiple Delta products and allows configuration and downloading in batches

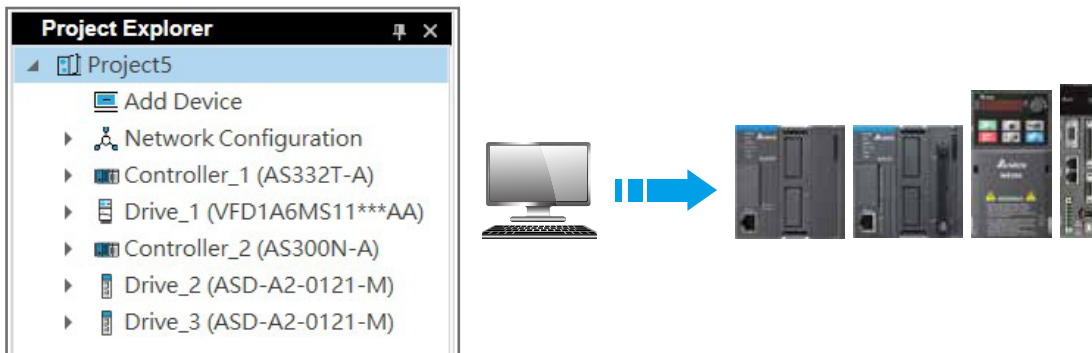

Note: Actual support functions will vary by series

Multiple Security Protection for Programs and Data

- **Security: provides 6 types of program protection for data safety**

- 16-digit password protection on main program
- 16-digit password protection on FBs
- Access denial mechanism on error login
- Data upload protection function
- Verification between Project (Programming ID) and CPU (PLC ID)

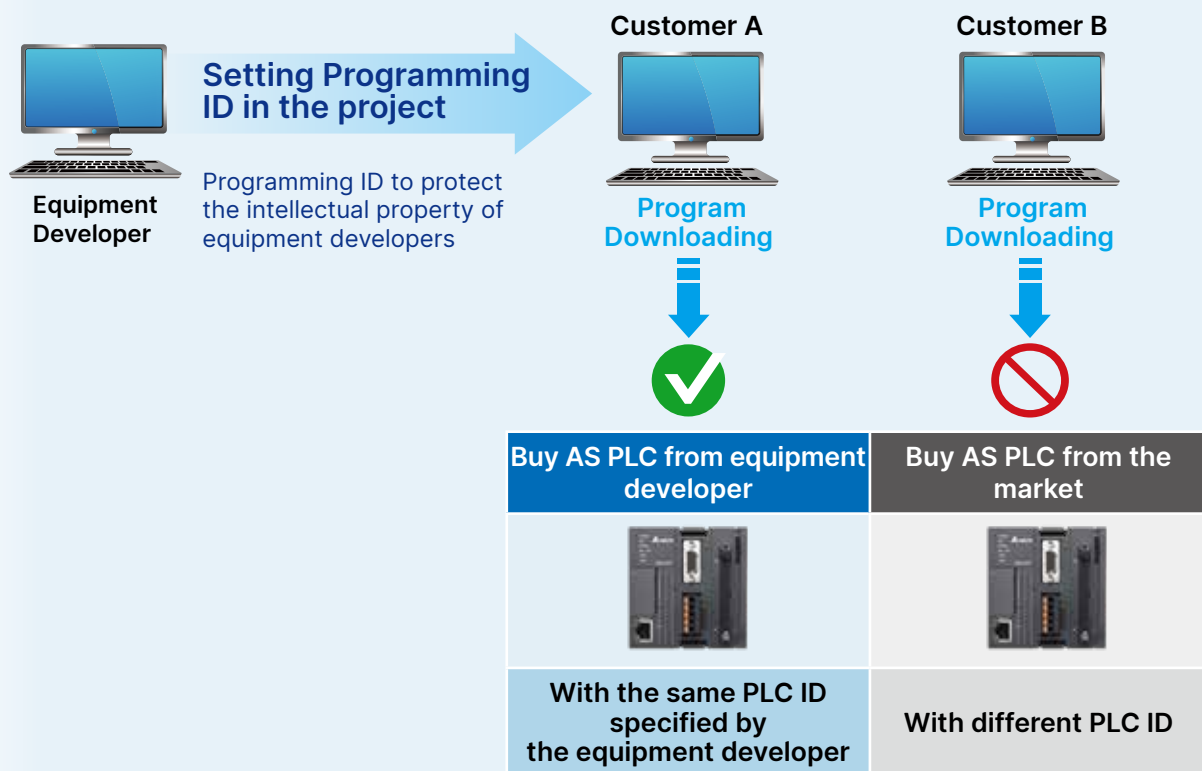

- Prevents direct copy from IC (AS200/300 series only)



Note: Actual support functions will vary by series

Model Name Explanation



CPUs

AS332T-A

AS	3	32		T		-	A
Series	Model	IO Pts. / Axis Qty.		Output Type / Motion Network			Type
	3: 300 2: 200 5 : 500 (Motion)	【200/300 CPU】 00: None 18: 18 pts. 20: 20 pts. 24: 24 pts. 28: 28 pts. 32: 32 pts.	【500 CPU】 16: 16 axes 24: 24 axes 32: 32 axes 64: 64 axes	【200/300 CPU】 N: None T: NPN P: PNP R: Relay MT: NPN+Diff.	【500 CPU】 C: CANopen, NPN E: EtherCAT, NPN EST: EtherCAT (P2P), NPN		【300/500 CPU】 A: HDC terminal B: EU terminal 【200 CPU】 A: Basic

AX-308EA0MA1T

AX-3	08	E	A0	MA1	T
Series	IO Pts./Axis Qty.	Motion Network	CPU Spec.	SYS Spec.	Output Type
CODESYS	【Logical】 00: None 24: 24 pts. 【Motion】 04: 4 axes 08: 8 axes 64: 64 axes	E: EtherCAT EL: EtherCAT (P2P) N: None	A0: Single core	MA1: SoftMotion PA1: Logical	T: NPN P: PNP

Digital I/O Modules

AS08AM10N-A

AS	08	AM	1	0	N	-	A
Series	IO Pts.	Classification	Function		Output type		Type
	08: 8 Pts. 16: 16 Pts. 32: 32 Pts. 64: 64 Pts.	AM: Digital input AN: Digital output AP: Digital input/output	0: No input 1: DC input (24 V)	0: No output 1: 0.5 A transistor / 2 A relay output 2: 0.1 A transistor output	N: No output T: NPN P: PNP R: Relay		A: Basic

Analog I/O Modules

AS04AD-A

AS	04	AD	-	A
Series	IO Channels	Classification		Type
	04: 4-channel 06: 6-channel 08: 8-channel	AD: Analog input DA: Analog output XA: Analog input/output		A: Voltage/Current B: Voltage C: Current

Temperature & Load Cell Modules

AS04RTD-A

AS	04	RTD	-	A
Series	IO Channels	Classification		Type
	02: 2-channel 04: 4-channel 06: 6-channe 08: 8-channel	RTD: Platinum resistance thermometer TC: Thermocouple LC: Load cell		A: Basic

Function Cards

AS-F232

AS	-	F	232
Series		Classification	Function
		F: Function card	232: RS-232 422: RS-422 485: RS-485 COPM: CANopen 2AD: 2-channel analog input 2DA: 2-channel analog output EN02: Ethernet PFN02: PROFINET OPC02 : OPC UA

Positioning & High Speed Counter Modules

AS02PU-A

AS	02	PU	-	A
Series	IO Channels	Classification		Type
	02: 2-channel 04: 4-channel	HC: High-speed counter PU: Pulse-train output		A: Basic

Communication Modules

AS00SCM-A

AS	00	SCM	-	A
Series	Function	Classification		Function
	00: Basement 01: Basic 04 : 4-CH	SCM: Serial DNET: DeviceNet SIL : IO-Link		A: Basic

Power Supply Modules

AS-PS02

AS	-	PS	02
Series		Classification	Function
		PS: Power supply	02: AC Input (100~240V) 02A: AC Input (100~240V) + DC Output (24V, 0.5A) 03C: AC input (100~240V) + DC output (24V, 3A) + RS-485

Product Models and Specifications

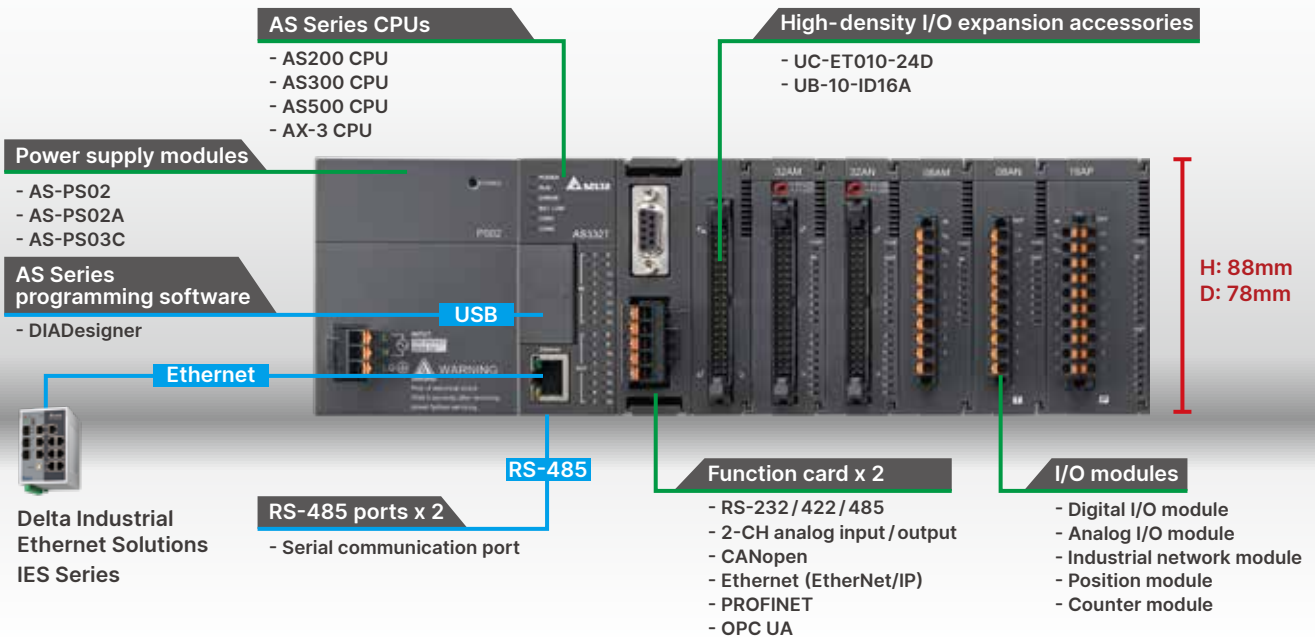

CPUs

AS500 CPUs



AS500 Series CPU Standard Specifications			
Program capacity 20MB	1GHz CPU	Expansion modules: 32	
USB/RS-232/485/Ethernet/CANopen	Micro SD Card	EtherNet/IP, Modbus CANopen	Advanced motion control
Model	Built-in I/O	Incremental Encoder	SSI Absolute Encoder
AS516E-B/AS524C-B AS532EST-B/AS564EST-B	16DI/8DO	2 CHs	1 CH

AS300 CPUs



AS300 Series CPU Standard Specifications (*1: Needs CANopen function card)			
Program capacity 128k steps	Basic instruction 25 ns	Real I/O capability: 1,024 pts Expansion modules: 32	
USB/RS-485 x 2 / EtherNet	Micro SD Card	Function card x 2	EtherNet/IP Modbus CANopen remote I/O ^(*)
			CANopen DS301 Position Control ^(*)
Model	Built-in I/O	High-speed Output	High-speed Input
AS332T-A, AS332P-A	16 DI/16 DO	6 axes 200kHz pulse output	6 channels 200kHz high-speed counters
AS324MT-A (Differential)	12 DI/12 DO	2 axes + 4 axes 200kHz pulse output	2 channels + 4 channels 200kHz high-speed counters
AS320T-B/AS320P-B	8 DI/12 DO	6 axes 200kHz pulse output	4 channels 200kHz high-speed counters
AS300N-A	-	-	-

CPUs

AS200 CPUs





AS200 Series CPU Standard Specifications			
Program capacity 64k steps	Basic instruction 25 ns	Real I/O capability: 1,024 pts Expansion modules: 32	
USB/RS-485 x 2/ EtherNet/CANopen	Micro SD Card	EtherNet/IP, Modbus CANopen remote I/O	CANopen DS301 Position Control
Model	Built-in I/O	High-speed Output	High-speed Input
AS228T-A/AS228P-A/ AS228R-A	16 DI/12 DO	6 axes 200kHz pulse output	4 channels 200kHz high-speed counters
AS218TX-A/AS218PX-A/ AS218RX-A	8 DI/6 DO 2 AI/2 AO	3 axes 200kHz pulse output	4 channels 200kHz high-speed counters

AX-3 CPU



AX-3 Series CPU Standard Specifications			
Program capacity 8 MB	Basic instruction 5 ns	Expansion modules: 32	
USB/RS-232/485/ Ethernet (1G)	Micro SD Card	EtherNet/IP, Modbus	CODESYS solution
Model	Built-in I/O	Encoder	High-speed Input / Output
AX-308EA0MA1T AX-364ELA0MA1T	16 DI/8 DO	Incremental encoder: 2 CHS SSI absolute encoder: 1 CH	200 kHz pulse output: 4 axes 200 kHz high-speed counters: 6 CHS
AX-304ELA0MA1T AX-324NA0PA1P	16 DI/8 DO	-	200 kHz pulse output: 4 PWM channels 200 kHz high-speed counters: 6 CHS
AX-300NA0PA1	-	-	-

Power Supply Modules

Power Supply Modules Specifications			
AS-PS02 	Input 100 V _{AC} ~ 240 V _{AC}	AS-PS02A 	Input 100 V _{AC} ~ 240 V _{AC}
	24 V _{DC} , 2 A (for internal bus)		24 V _{DC} , 1.5 A (for internal bus) 24 V _{DC} , 0.5 A (for external I/O)
AS-PS03C 	Input 100 V _{AC} ~ 240 V _{AC}		
	24 V _{DC} , 3 A (for external I/O)		
	RS-485 (Modbus)		
	Provides information of power status/abnormal alarm/life prediction		

Product Specifications - AS300 & AS200 Series

Model		AS332T-A AS332P-A	AS324MT-A	AS320T-B AS320P-B	AS300N-A	AS228T-A AS228P-A AS228R-A	AS218TX-A AS218PX-A AS218RX-A
Programming Languages		Ladder Diagram (LD), Structured Text (ST), Continuous Function Chart (CFC), Sequential Function Chart (SFC), C Language					
Instruction Processing Speed	LD Instruction	25 ns					
	MOV Instruction	0.15 μ s					
	Elementary Arithmetic for Integers	0.92 μ s ~ 1.02 μ s					
	Elementary Arithmetic for Floating Point	1.69 ~ 1.85 μ s					
Program Capacity		128k steps			64k steps		
Memory Capacity	Data (D)	64k words (including 30k user-defined, 30k software configuration and 4k special registers)					
	Extension (FR)	64k words (user parameter storage)					
Function Cards		The CPUs support up to 2 function cards			-		
Max. Extension Modules		32 modules (max. 16 analog modules / 4 communication modules)					
Max. Number of Real Inputs / Outputs		1,024 points (input & output)					
CPU Built-in Inputs / Outputs		16 DI / 16 DO	12 DI / 12 DO	8 DI / 12 DO	-	16 DI / 12 DO	8 DI / 6DO & 2 AI / 2AO
CPU Built-in Differential Inputs / Outputs		-	4 inputs + 4 outputs	-			
Input / Output Devices	X	1,024 inputs (X0.0 ~ X63.15)					
	Y	1,024 outputs (Y0.0 ~ Y63.15)					
Bit Devices	M	8,192 bits (M0 ~ M8191)					
	S	2,048 bits (S0 ~ S2047)					
Timer	T	512 (T0 ~ T511)					
16-bit Counter	C	512 (C0 ~ C511)					
32-bit Counter	HC	256 (HC0 ~ HC255)					
Pulse Output		Open collector: 6 axes, 200 kHz	Open collector: 4 axes, 200 kHz Differential: 2 axes, 4 MHz	Open collector: 6 axes, 200 kHz	-	Open collector: 6 axes, 200 kHz	Open collector: 3 axes, 200 kHz
High-Speed Counter		General: 6 CHs, 200 kHz	General: 4 CHs, 200 kHz Differential: 2 CHs, 4 MHz	General: 4 CHs, 200 kHz	-	General: 4 CHs, 200 kHz	General: 4 CHs, 200 kHz
DO Type		AS332T-A: NPN AS332P-A: PNP	Diff. / NPN	AS320T-B: NPN AS320P-B: PNP	-	AS228T-A: NPN AS228P-A: PNP AS228R-A: Relay	AS218TX-A: NPN AS218PX-A: PNP AS218RX-A: Relay
Built-in Communication Port		USB, Ethernet, RS-485 x 2				USB, Ethernet, RS-485 x2, CANopen	
Communication Protocol		Modbus, Modbus TCP, EtherNet/IP, CANopen (requires a CANopen function card)				Modbus, Modbus TCP, EtherNet/IP, CANopen	
Ethernet Connection Resource		Modbus (Client / Server): 32 / 32 EtherNet/IP (CIP): 32				Modbus (Client / Server): 16 / 16 EtherNet/IP (CIP): 16	
Data Backup (Without Battery)	Program	Flash ROM, rewritable up to 100,000 times					
	Latched Area	MRAM, no rewriting limit					
CANopen DS301	Connectable Slave Stations	Max. 64 points					
	CPDO Data Capacity (Host)	Max. 2,000 bytes (Read & Write)					
	PDO Data Capacity (Slave)	Max. 8 PDO (Read & Write); Max. 8 bytes for each PDO					
Real-time Clock (RTC)		General Lithium button battery (CR1620)					
Self-Diagnosis Function		CPU errors, built-in memory errors, and more					
Rated Input Current	AS-PS02 / AS-PS02A / AS-PS03C	110 V _{AC} ~ 240 V _{AC} (\pm 10%)					
	CPU	24 V _{DC} (\pm 10%)					
	Extension Modules	24 V _{DC} (\pm 10%)					

Product Specifications - AS500 Series

Model		AS516E-B	AS532EST-B	AS564EST-B	AS524C-B
Programming Languages		Ladder Diagram (LD), Structured Text (ST)			
Instruction Processing Speed	Boolean Operation	0.05 μs			
	MOV Instruction	0.11 μs			
	Elementary Arithmetic for Integers	0.24 μs			
	Elementary Arithmetic for Floating Point	0.30 μs			
Program Capacity		20 MB			
Data Capacity		20 MB			
Max. Extension Modules		32 modules (max. 16 analog modules)			
CPU Built-in Inputs / Outputs		16 DI / 8 DO			
CPU Built-in Encoder Interface		Incremental x2 / SSI absolute x1			
I/O Devices	I (Input)	128 bytes			
	Q (Output)	128 bytes			
Memory Devices	M (Memory)	128k bytes			
Pulse Output		-			
High-Speed Counter		-			
DO Type		NPN			
Built-in Communication Ports		USB, Ethernet, RS232, RS485, EtherCAT, CANopen			USB, Ethernet x2, RS232, RS485, CAN Motion, CANopen
Communication Protocols		Modbus, Modbus TCP, EtherNet/IP, EtherCAT, CANopen DS301			Modbus, Modbus TCP, EtherNet/IP, CANopen DS301 & DS402
Ethernet Connection Resource		Modbus TCP (Client / Server): 16 / 16 EtherNet/IP (CIP): 8			
Data Backup (Without Battery)	Program	Flash ROM, rewritable up to 100,000 times			
	Latched Area	MRAM, no rewriting limit			
Motion Network	Protocol	EtherCAT **			CANopen (DS402) **
	Total Axis (Real + Virtual)	32	64	64	32
	Total Real Axis (Motion + P2P)	16	32	64	24
	Total Real Axis (Motion)	16	4	8	24
	Connectable devices	64	64	96	24
CANopen (DS301)	PDO Data Capacity (Host)	CANopen DS301: Max. 8 PDO (read & write)			
	PDO Data Capacity (Slave)	CANopen DS301: Max. 8 PDO (read & write); Max. 8 bytes for each PDO			
Real-time Clock (RTC)		General Lithium button battery (CR1620)			
Self-Diagnosis Function		CPU errors, built-in memory errors, and more			
Rated Input Current	AS-PS02 / AS-PS02A / AS-PS03C CPU	110 V _{AC} ~ 240 V _{AC} (±10%)			
	Extension Modules	24 V _{DC} (±10%)			

*1: Delta drive only

Product Specifications - AX-3 Series

Model		AX-300N	AX-324N	AX-304EL	AX-308E	AX-364EL
Programming Languages		Ladder Diagram (LD), Structured Text (ST), Continuous Function Chart (CFC), Sequential Function Chart (SFC), Function Block Diagram (FBD), Instruction List (IL)				
Instruction Processing Speed	Boolean Operation	5 ns				
	MOV Instruction	-				
	Elementary Arithmetic for Integers	5 ns				
	Elementary Arithmetic for Floating Point	33 ns				
Program Capacity		8 MB				
Data Capacity		16 MB				
Max. Extension Modules		32 modules (max. 16 analog modules)				
CPU Built-in Inputs/Outputs		-	16 DI/8 DO			
CPU Built-in Encoder Interface		-			Incremental x 2 / SSI absolute x 1	
I/O Devices	I (Input)	8,192 bytes				
	Q (Output)	8,192 bytes				
Memory Devices	M (Memory)	512k bytes				
Pulse Output		-	Open collector: 4 CHs, 200 kHz (PWM)		Open collector: 4 axes, 200 kHz	
DO Type		-	NPN			
High-Speed Counter		-	General: 6 CHs, 200 kHz			
Built-in Communication Ports		USB, Ethernet (Switch), RS232, RS485		USB, Ethernet (Switch) ^{*1} , RS232, RS485, EtherCAT		
Communication Protocols		Modbus, Modbus TCP, EtherNet/IP, OPC UA (Server)		Modbus, Modbus TCP, EtherNet/IP, EtherCAT, OPC UA (Server)		
Ethernet Connection Resource		Modbus TCP (Client+Server): 32 EtherNet/IP (CIP): Input=64; Output=64				
Data Backup (Without Battery)	Program	Flash ROM, rewritable up to 100,000 times				
	Latched Area	MRAM, no rewriting limit				
Motion Network	Protocol	-		EtherCAT		
	Total Axis (Real + Virtual)	-	-	8	16	128
	Total Real Axis (Motion + P2P)	-	-	4	8 + 4 (PTO)	64 + 4 (PTO)
	Total Real Axis (Motion)	-	-	0	8 + 4 (PTO)	8 + 4 (PTO)
	Connectable devices	-	-	32	64	96
Real-time Clock (RTC)		General Lithium button battery (CR1620)				
Self-Diagnosis Function		CPU errors, built-in memory errors, and more				
Rated Input Current	AS-PS02/ AS-PS02A/ AS-PS03C	110 V _{AC} ~ 240 V _{AC} (±10%)				
	CPU	24 V _{DC} (±10%)				
	Extension Modules					

*1: AX-304EL only supports 1 Ethernet port

Electrical and Environmental Specifications

Item	Specifications	
Internal Power Consumption	AS332T-A AS332P-A AS324MT-A AS320T-B AS320P-B	150 mA
	AS300N-A	125 mA
	AS228T-A AS228P-A	141.7 mA
	AS218TX-A AS218PX-A	204.2 mA
	AS228R-A	179.2 mA
	AS218RX-A	220.8 mA
	AS516E-B AS524C-B AS532EST-B AS564EST-B	333 mA
	AX-308E AX-304EL AX-364-EL	458.3 mA
	AX-300N	458.3 mA
	AX-324N	458.3 mA
Extension Modules	Digital relay output < 150 mA, other modules < 80 mA	
Operating Temperature	-20 ~ 60 °C (AX Series CPU: -20 ~ 55 °C)	
Storage Temperature	-40 ~ 80 °C	
Operating Humidity	5 ~ 95%, non-condensing	
Storage Humidity	5 ~ 95%, non-condensing	
Vibration	IEC 61131-2, IEC 60068-2-6 (TEST Fc); 5 Hz ≤ f ≤ 8.4 Hz, constant amplitude 3.5 mm; 8.4 Hz ≤ f ≤ 150 Hz, constant acceleration 1g	
Shock	IEC 61131-2, IEC 60068-2-27 (TEST Ea); 15g peak, 11ms duration, half-sine	
Operating Environment	Non-corrosive gas	
Installation	Inside of the control panel	
Pollution Degree	2	
Protection Rating	IP20	
Conformal Coating	Yes	

Ethernet Specifications

Item		AS300 Series	AS200 Series	Note	
Protocols		Modbus TCP, EtherNet/IP, SMTP, HTTP		Supports all protocols at the same time	
Modbus TCP	Connection (Server)	32	16		
	Connection (Client)	32	16		
	RTU-EN01 Connection	4	4		
Socket	TCP Connection	4	2		
	UDP Connection	4	2		
SMTP	E-mail Connection	4	2		
Operation Mode		Scanner / Adapter			
EtherNet/ IP	CIP_IO Connection	CIP Connection	32 (Client + Server)	16 (Client + Server)	Shared with IO connection
		TCP Connection	16 (Client + Server)	8 (Client + Server)	Shared with IO connection
		Requested Packet Interval (RPI)	5ms ~ 1,000ms		Default: 20ms
		Max. Performance	3,000 pps		
		Max. Capacity per Connection	500 bytes		
	CIP_Explicit Message	Class 3 (Connected Type)	32 (Servers), shared with UCMM	16 (Servers), shared with UCMM	Shared with IO connection
		UCMM (Non-Connected Type)	32 (Clients + Servers), shared with Class 3	16 (Clients + Servers), shared with Class 3	Shared with IO connection
		Supported CIP Objects	Identity, Message Router, Assembly, Connection Manager, Port, TCP/IP interface, Ethernet link, Vendor specific		
	CIP_Produced TAG	Max. CIP Connections	32 (Servers)	16 (Servers)	Shared with IO connection
		Max. Capacity	400 bytes		
Requested Packet Interval (RPI)		5 ms ~ 1000ms			
CIP_Consumed TAG	Max. CIP Connections	32 (Clients + Servers)	16 (Clients + Servers)	Shared with IO connection	
	Max. Capacity	400 bytes			
	Requested Packet Interval (RPI)	5 ms ~ 1000 ms			
AS00SCM (RTU) + AS-FEN02 Connection Nodes		15	8	AS RTU Mode	

Please visit [Delta's official website](#) for selection

Ethernet Specifications





Item		AS500 Series	AX-3 Series	Note	
Protocol		Modbus TCP, EtherNet/IP, Socket	Modbus TCP, EtherNet/IP, Socket, OPC-UA	Supports all protocols at the same time	
Modbus TCP	Connection (Server)	16	32		
	Connection (Client)				
Socket	TCP Connection	8			
	UDP Connection				
EtherNet/IP	Operation Mode		Adapter	Scanner / Adapter	
	CIP_IO Connection	CIP Connection	8	Input = 64; Output = 64	Shared with all servers
		TCP Connection	16	8	Shared with all servers
		Requested Packet Interval (RPI)	5 ms ~ 1,000 ms	20 ms ~ 1,000 ms	Default: 20 ms
		Max. Performance	3,000 pps	3,000 pps	
	Max. Capacity per Connection		500 bytes		
	CIP_Explicit Message	Class 3 (Connected Type)	8	8	Shared with all servers
UCMM (Non-Connected Type)		16	8	Shared with all servers	
Supported CIP Objects		Identity, Message Router, Assembly, Connection Manager, Port, TCP/IP interface, Ethernet link, Vendor specific			

Please visit Delta's official website for selection





Item		AS500 Series	AX-3 Series
OPC UA (Server)	Default TCP Port		TCP: 4840 (configurable)
	CMax Sessions (Client)		5
	Max. Monitored Items		1,000
	Sampling Rate (ms)		100/300/500/1,000/2,500/5,000
	Max. Subscriptions		100
	Max. Published Variables		10,000
	Max. Value Attributes		10,000
	Max. Published Structure Definitions		100





I/O Modules

Digital Input Modules

				<p>Rated input voltage 5 ~ 24 V_{DC}</p> <p>Response time 1 ms</p> <p>Filter function 1 ~ 20 ms</p> <p>Screwless removable terminal block 8 / 16 inputs</p>
8 inputs	16 inputs	32 inputs	64 inputs	
Easy wiring terminal block	Easy wiring terminal block	High-density MIL terminal block	High-density MIL terminal block	
AS08AM10N-A	AS16AM10N-A	AS32AM10N-A	AS64AM10N-A	



Digital Output Modules

				<p>NPN (Sink) or PNP (Source) module</p> <p>Response time 1ms (Transistor) 10ms (Relay)</p> <p>Screwless removable terminal block 8 / 16 outputs</p>
8 outputs	8 outputs	8 outputs	32 outputs	
Easy wiring terminal block Transistor output NPN (Sink)	Easy wiring terminal block Relay output	Easy wiring terminal block Transistor output PNP (Source)	High-density MIL terminal block Transistor output NPN (Sink)	
AS08AN01T-A	AS08AN01R-A	AS08AN01P-A	AS32AN02T-A	





			
16 outputs	16 outputs	16 outputs	64 outputs
Easy wiring terminal block Transistor output NPN (Sink)	Easy wiring terminal block Relay output	Easy wiring terminal block Transistor output PNP (Source)	High-density MIL terminal block Transistor output NPN (Sink)
AS16AN01T-A	AS16AN01R-A	AS16AN01P-A	AS64AN02T-A

I/O Modules

Digital I/O Modules

			<p>NPN (Sink) or PNP (Source) module</p> <p>Rated input voltage 5 ~ 24 V_{DC} Filter function 1 ~ 20ms</p> <p>Screwless removable terminal block</p> <p>Response time 1ms (Transistor) 10ms (Relay)</p>
16 inputs / outputs	16 inputs / outputs	16 inputs / outputs	
Easy wiring terminal block 8 inputs/8 transistor outputs NPN (Sink)	Easy wiring terminal block 8 inputs 8 relay outputs	Easy wiring terminal block 8 inputs/8 transistor outputs PNP (Source)	
AS16AP11T-A	AS16AP11R-A	AS16AP11P-A	



Analog I/O Modules

				
4 channels	8 channels	8 channels	4 channels	6 channels
Analog input	Analog input	Analog input	Analog output	Analog input/output
AS04AD-A	AS08AD-B	AS08AD-C	AS04DA-A	AS06XA-A
Conversion time 2ms/channel	50/60Hz filter	A: Voltage and current B: Voltage C: Current		Resolution AI: 16-bit AO: 12-bit
Accuracy ±0.2%	4/6/8 CHs	Module monitoring/configuration		Differential inputs

Load Cell Module

	<table border="1"> <tr> <th colspan="2">Functions</th> </tr> <tr> <td>50/60Hz filter</td> <td>High-speed dynamic measurement</td> </tr> <tr> <td>2 channels of independent sampling</td> <td>Accuracy 0.04% of full-scale</td> </tr> <tr> <td>2 CHs</td> <td>Connectable to 4-wire/6-wire load cell sensor</td> </tr> <tr> <th colspan="2">Software</th> </tr> <tr> <td>Filter function</td> <td>Multi-point calibration</td> </tr> <tr> <td>Online monitoring/configuration</td> <td></td> </tr> </table>	Functions		50/60Hz filter	High-speed dynamic measurement	2 channels of independent sampling	Accuracy 0.04% of full-scale	2 CHs	Connectable to 4-wire/6-wire load cell sensor	Software		Filter function	Multi-point calibration	Online monitoring/configuration	
Functions															
50/60Hz filter	High-speed dynamic measurement														
2 channels of independent sampling	Accuracy 0.04% of full-scale														
2 CHs	Connectable to 4-wire/6-wire load cell sensor														
Software															
Filter function	Multi-point calibration														
Online monitoring/configuration															
2 channels															
AS02LC-A															

Pulse Unit Modules

		<p>Input: AS02PU: 200kHz</p> <p>Output: AS02PU: 200kHz AS04PU: 100kHz</p> <p>Open Collector/Diff.</p> <p>2/4 CHs</p> <p>Support Motion APIs</p>
2 channels	4 channels	
Differential	Open Collector	
AS02PU-A New	AS04PU-A New	

High Speed Counter Module

	<p>200kHz</p> <p>Incremental / Absolute (SSI)</p> <p>Open Collector/Diff.</p> <p>2 CHs</p> <p>Compare / Capture</p>
2 channels	
Open collector / Diff.	
AS02HC-A New	

■ Temperature Measurement Modules



4 channels	6 channels
PT, NI temperature sensor	PT, NI temperature sensor
AS04RTD-A	AS06RTD-A

Conversion time 200 ms/channel		Resolution 0.1°C/0.1°F	Wire breaking detection
Overall accuracy ±0.1%	50/60 Hz filter	Module monitoring/configuration	4/6 CHs
Pt100/Ni100/Pt1000/Ni1000/JPt100/LG-Ni1000/Cu50/Cu100, resistor 0~300Ω, 0~3,000Ω			



4 channels	8 channels
TC temperature sensor	TC temperature sensor
AS04TC-A	AS08TC-A

Conversion time 200 ms/channel		Resolution 0.1°C/0.1°F	Disconnection detection
Overall accuracy ±0.5%	50/60 Hz filter	Module monitoring/configuration	4/8 CHs
J, K, R, S, T, E, N, B type thermocouple; ±100mV			

■ Communication Modules



2 COM ports
AS00SCM-A

COM port	RS-232C	RS-422	RS-485	CANopen	Ethernet	PROFINET
Function	Supports standard Modbus protocols and user-defined protocols			Slave mode and RTU mode	EtherNet/IP RTU mode	PROFINET RTU mode
Software	SCMSoft			CANopen Builder	EIP Builder	-





Note: The above functions need optional function cards





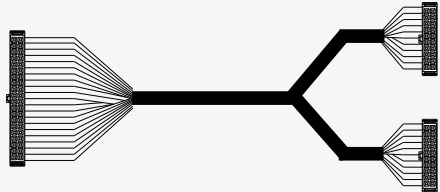





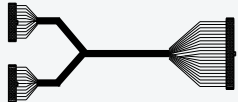

DeviceNet	IO-Link
AS01DNET-A	AS04SIL-A New



COM port	DeviceNet	IO-Link (4-CH)
Function	Master/Slave/RTU	Master
Software	DeviceNet Builder	HWCONFIG

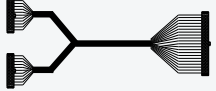

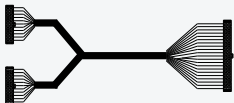
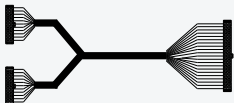

Accessory Selection for High-density Modules

Model Name		
AS332T-A AS332P-A AS324MT-A	UC-ET010-24D (1M) UC-ET020-24D (2M) UC-ET030-24D (3M)	UB-10-ID16A
		
		UB-10-ID16A (NPN/PNP) UB-10-OR16A (NPN to Relay) UB-10-OR16B (PNP to Relay)
		 or 

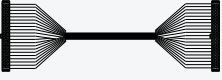
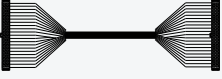
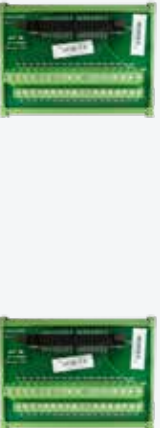
Model Name				
UB-10-ID16A	UC-ET010-24D (1M) UC-ET020-24D (2M) UC-ET030-24D (3M)	AS32AM10N-A	UC-ET010-24B (1M) UC-ET020-24B (2M) UC-ET030-24B (3M)	UB-10-ID32A
				

Model Name				
UB-10-ID16A or UB-10-OR16A (Relay)	UC-ET010-24D (1M) UC-ET020-24D (2M) UC-ET030-24D (3M)	AS32AN02T-A	UC-ET010-24B (1M) UC-ET020-24B (2M) UC-ET030-24B (3M)	UB-10-OT32A
 				

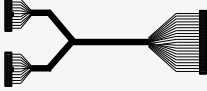
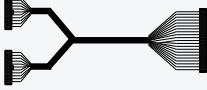
Model Name				
UB-10-ID16A	UC-ET010-24D (1M) UC-ET020-24D (2M) UC-ET030-24D (3M)	AS64AM10N-A	UC-ET010-24B (1M) UC-ET020-24B (2M) UC-ET030-24B (3M)	UB-10-ID32A
	 		 	

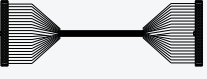
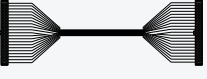
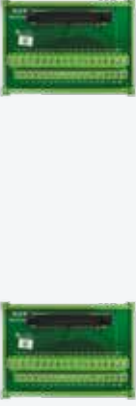
Model Name				
UB-10-ID16A or UB-10-OR16A (Relay)	UC-ET010-24D (1M) UC-ET020-24D (2M) UC-ET030-24D (3M)	AS64AN02T-A	UC-ET010-24B (1M) UC-ET020-24B (2M) UC-ET030-24B (3M)	UB-10-OT32A
 	 		 	

Dimensions

CPU

AS516E-B **New** / AS524C-B **New** /
AS532EST-B **New** / AS564EST-B **New**

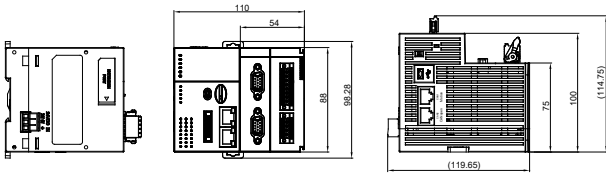

AX-308E **New** / AX-364EL **New**

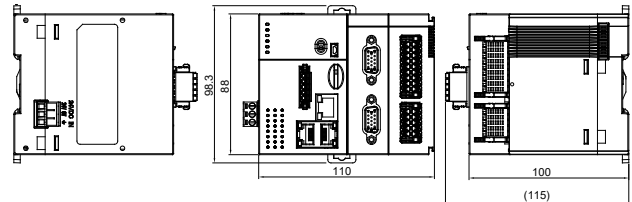

AX-304EL **New** / AX-324N **New**

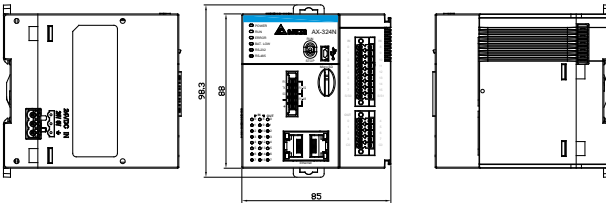

AX-300N **New**

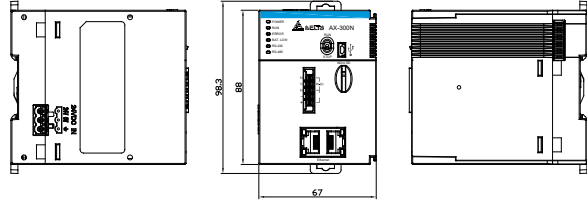

AS332T-A / AS332P-A / AS324MT-A

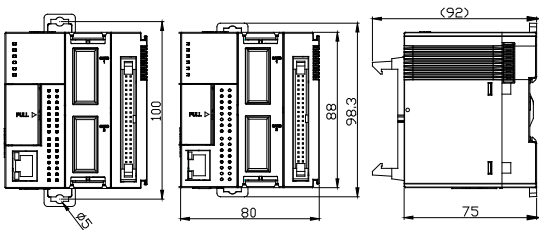

AS300N-A

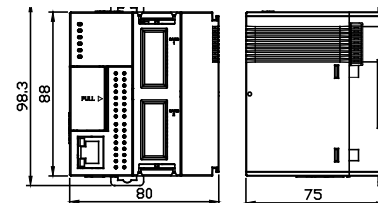

AS320T-B / AS320P-B

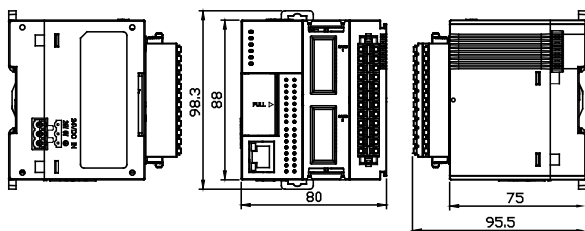

AS228T-A / AS228P-A / AS228R-A /
AS218TX-A / AS218PX-A / AS218RX-A

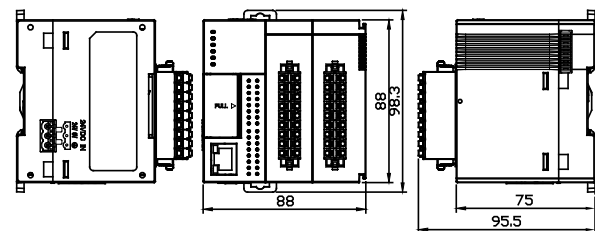

(Unit: mm)

Digital I/O Modules

AS08AM10N-A / AS08AN01R-A /
AS08AN01T-A / AS08AN01P-A

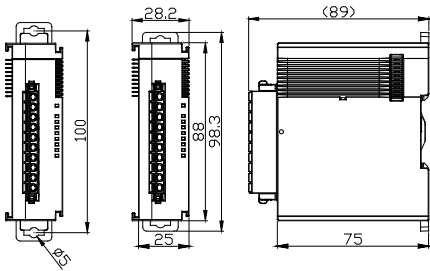

AS16AM10N-A / AS16AN01R-A / AS16AN01T-A /
AS16AN01P-A / AS16AP11R-A / AS16AP11T-A /
AS16AP11P-A

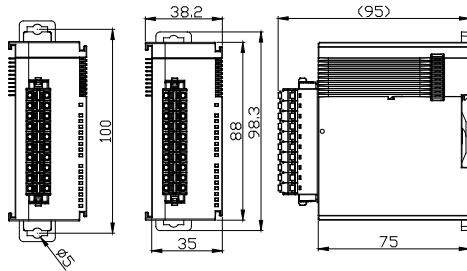

AS32AM10N-A / AS32AN02T-A

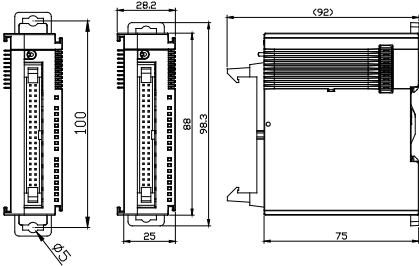

AS64AM10N-A / AS64AN02T-A

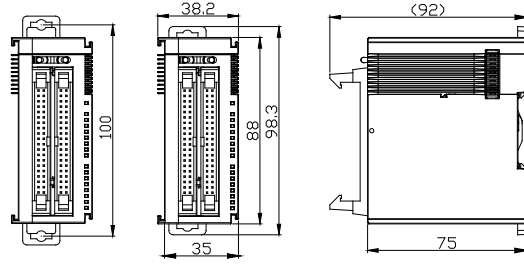

Power Supply Modules

AS-PS02 / AS-PS02A

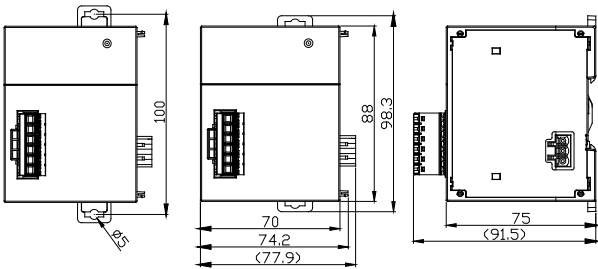

AS-PS03C **New**

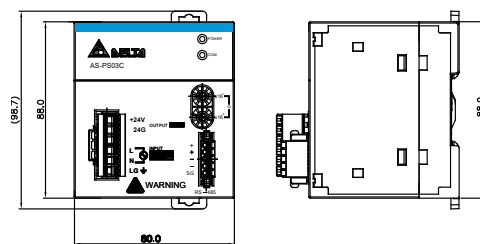

Pulse Unit Modules

AS02PU-A **New** / AS04PU-A **New**

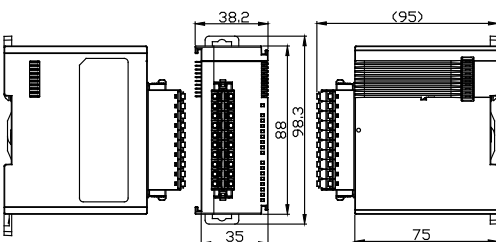

(Unit: mm)

Dimensions

Communication Modules

AS00SCM-A

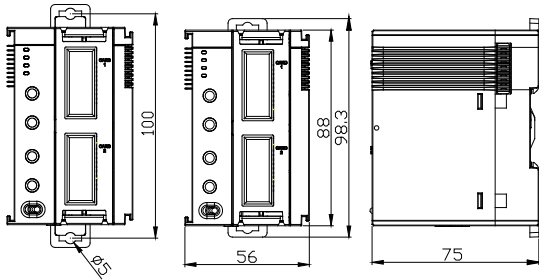

AS01DNET-A

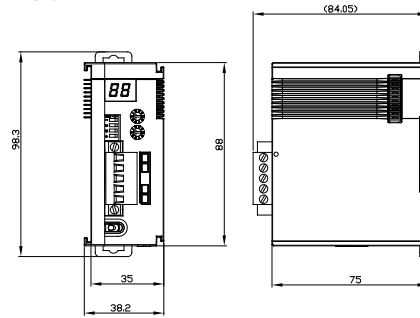

AS04SIL-A **New**

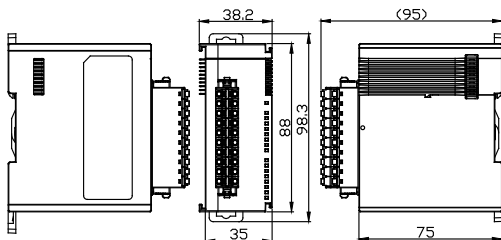

High-speed Counter Module

AS02HC-A **New**

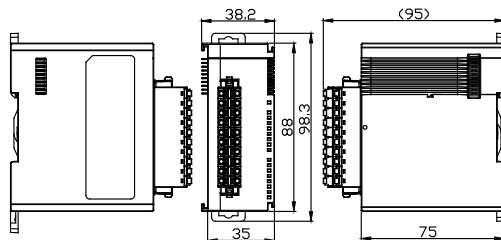

Analog Modules

AS02LC-A / AS04AD-A / AS04DA-A / S04TC-A /
AS04RTD-A / AS06XA-A / AS08AD-B /
AS08AD-C / AS06RTD-A / AS08TC-A

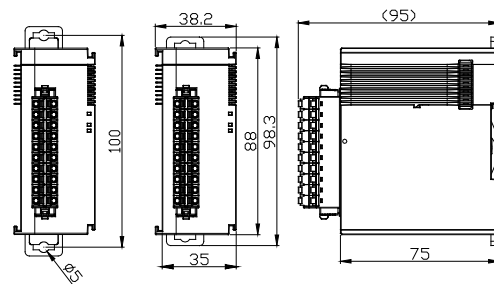

Connector Converter

UB-10-IO32D **New**

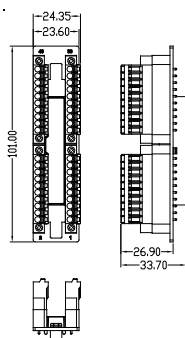

Note:
Can NOT be installed on two consecutive
high-density modules (interference)

(Unit: mm)

Function Cards

AS-F232

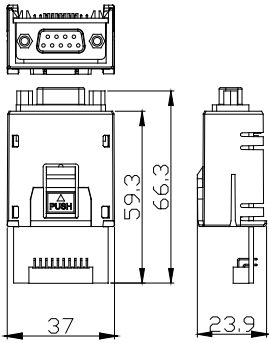

AS-FCOPM

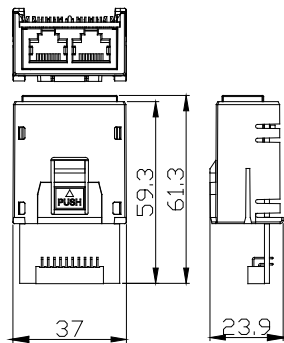

AS-F2AD / AS-F2DA /
AS-F422 / AS-F485

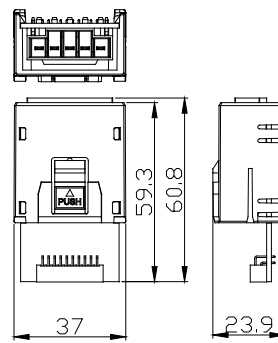

AS-FEN02
AS-FPFN02 **New**
AS-FOPC02 **New**

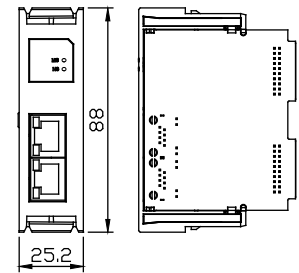

Cable (MIL)

UC-ET010-24D (1M) / UC-ET020-24D (2M) /
UC-ET030-24D (3M)

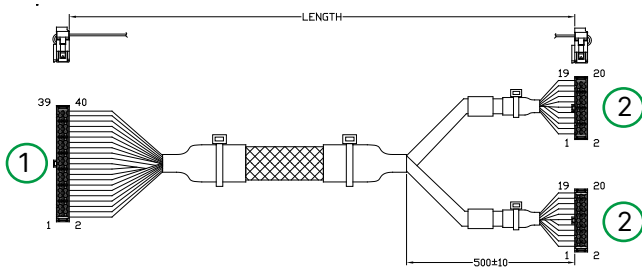

UC-ET010-24B (1M) / UC-ET020-24B (2M) /
UC-ET030-24B (3M)

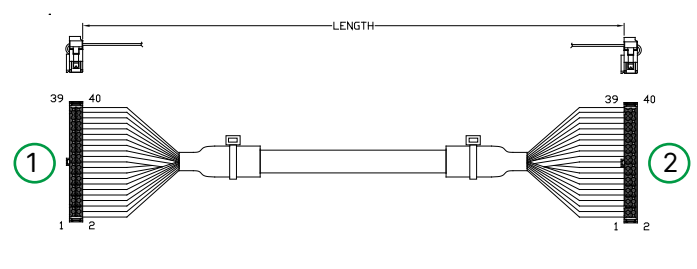

Serial	Name	Description
①	40-pin terminal	Connects to modules
②	20-pin terminal	Connects to external terminal modules UB-10-ID16A or UB-10-OR16A or UB-10-OR16B

Serial	Name	Description
①	40-pin terminal	Connects to modules
②	40-pin terminal	Connects to external terminal modules UB-10-ID32A or UB-10-OT32A

Installation Notes:

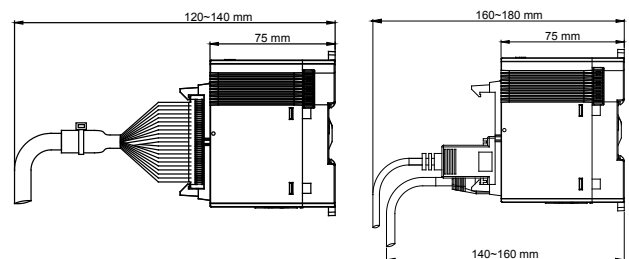
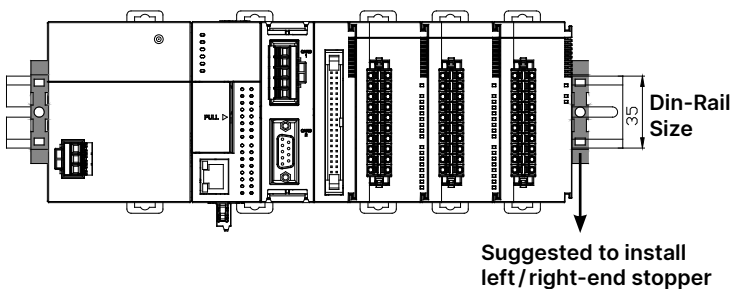

(Unit: mm)

Dimensions

External Terminal Modules

UB-10-OR16A / UB-10-OR16B

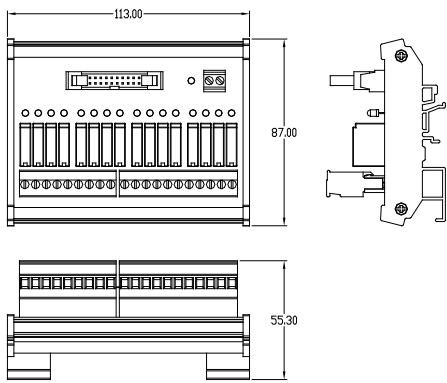

UB-10-OT32A

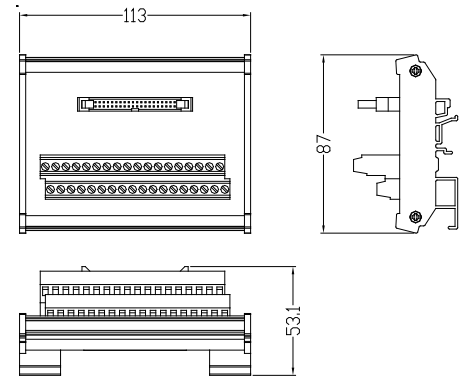

UB-10-ID16A

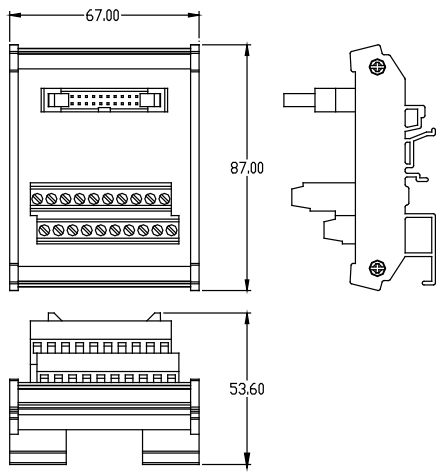

UB-10-ID32A

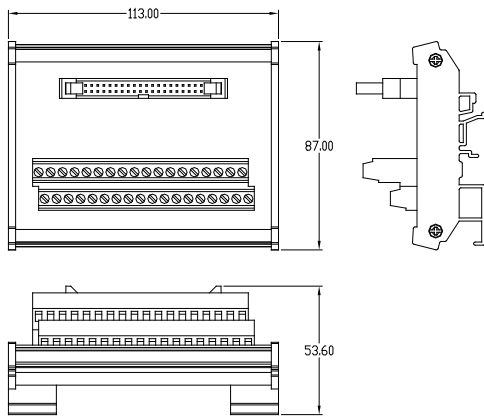

Auxiliary Connected Power Module

AS-ATXB

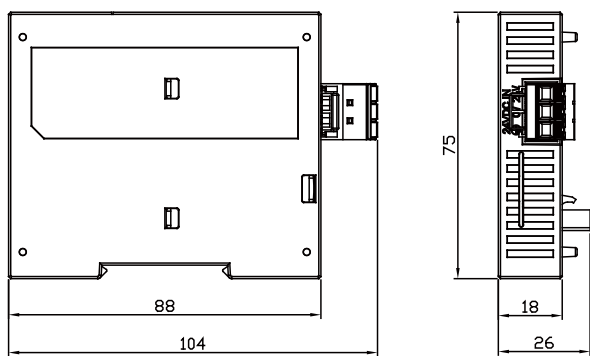

(Unit: mm)

Ordering Information

■ CPUs

Name	Model	Instruction Speed/Performance	Memory / CPU Clock	Max. Inputs & Outputs/Extension Module (Max. Extension Racks)	Memory Card	Certification
CPU	AS200 AS300	LD: 25 ns MOV: 0.15 μs 40k steps/1ms (LD 40%, MOV 60%)	RAM: 2 MB ROM: 4 MB CPU clock: 400 MHz	Right-side + remote expansion: 1,024 pts/32 modules (Max. 15 racks)	Micro SD Max. 32 GB	CE/UL
	AS500 New	Boolean: 0.05 μs Integer: 0.24 μs Float: 0.30 μs	RAM: 20 MB ROM: 20 MB CPU clock: 1 GHz	Right-side expansion: 1,024 pts/32 modules		
	AX-3 New	Boolean: 5 ns Integer: 5 ns Float: 33 ns	RAM: 128 MB ROM: 4 GB CPU clock: 800 MHz	Right-side expansion: 1,024 pts/32 modules		

Name	Model	Program Capacity	Built-in I/O	DO Type	Terminal Block	High-speed Counter	Pulse-train Output	Built-in Communication	Function Card Slot		
CPU	AS332T-A	128k steps	16 DI/16 DO	NPN	MIL	6 CHs, 200 kHz	6 Axes, 200 kHz (12 CHs, 200 kHz)	USB RS-485*2 Ethernet	2		
	AS332P-A			PNP							
	AS324MT-A			Diff./NPN						2 CHs, 4 MHz (Diff.) 4 CHs, 200 kHz	2 Axes, 4 MHz (Diff.) 4 Axes, 200 kHz
	AS320T-B			NPN						4 CHs, 200 kHz	6 Axes, 200 kHz (12 CHs, 200 kHz)
	AS320P-B			PNP							
	AS300N-A			-						-	-
	AS228T-A	64k steps	16 DI/12 DO	NPN	EU	4 CHs, 200 kHz	6 Axes, 200 kHz (12 CHs, 200 kHz)	USB RS-485*2 Ethernet CANopen			
	AS228P-A			PNP							
	AS228R-A			Relay							
	AS218TX-A			NPN						8 DI/6 DO 2 AI/2 AO ^(*)	3 Axes, 200 kHz (6 CHs, 200 kHz)
	AS218PX-A			PNP							
	AS218RX-A			Relay						-	
	New AX-300N ^{(*)2}	8MB	-	-	-	-	-	USB RS-232 RS-485 Ethernet			
	New AX-324N ^{(*)2}			PNP	6 CHs, 200 kHz	4 CHs, 200 kHz (PWM)					
Motion CPU	New AS516E-B (EtherCAT, 16 axes)	20MB	16 DI/8 DO	NPN	EU	-	-	USB RS-232 RS-485 Ethernet CANopen EtherCAT			
	New AS532EST--B ^{(*)2} (EtherCAT, 32 axes, P2P)										
	New AS564EST-B ^{(*)2} (EtherCAT, 64 axes, P2P)										
	New AS524C-B (CANopen, 24 axes)	8MB	-	-	-	-	-	USB RS-232 RS-485 Ethernet*2 CANopen CAN Motion			
	New AX-304EL ^{(*)2} (EtherCAT, 4 axes, P2P)										
	New AX-308E ^{(*)2} (EtherCAT, 8 axes)										
	New AX-364EL ^{(*)2} (EtherCAT, 64 axes, P2P)										

Note:

*1: Built-in AIO specification:

- AI: 12-bit, 3ms, supports ±10 V / ±20 mA / 4 ~ 20 mA
- AO: 12-bit, 2ms, supports ±10 V / ±20 mA

*2: Please contact our distributors for release date

Ordering Information

■ Software

Product Name	License	Descriptions	Supported Device
ISPSOft [V3]	Free	PLC programming software	AS Series, AH Series, DVP Series
DIADesigner-AX [V1]	Free	PLC programming software	AX-3 Series
COMMGR [V1 & V2]	Free	Communication management software	AS Series, AH Series, DVP Series
DCISOft [V1]	Free	Ethernet configuration software	AH series Ethernet / serial communication modules, AS series SCM modules, DVP series built-in Ethernet PLCs, DVP series Ethernet / serial communication modules, IFD series Ethernet modules
	Free	SCM serial communication module planning software	AS Series / AH Series / DVP Series built-in CANopen communication modules
CANopen Builder [V5]	Free	CANopen configuration software / motion control programming software	AS Series / AH Series / DVP Series built-in Ethernet communication modules
EIP Builder [V1]	Free	EtherNet/IP configuration software	AS Series / AH Series / DVP Series built-in Ethernet communication modules
Delta OPC [V2] (HASP-20-OPC01)	Hardware License (USB)	Delta OPC Server	AS Series / AH Series
DIADesigner	Free	Integrated development & engineering software	<ul style="list-style-type: none"> • Controllers: AS Series • Motor Drives: C2000 Family, M300 Family, VFD-EL Family, MPD Series • Servo Drives: ASDA-A2-L & M Series, ASDA-B2-B & F Series, ASDA-A3-L & M Series, ASDA-B3-L & M Series • Temperature Controllers: DTC Series

■ Power Supply Modules

Name	Model	Input	Output	Certification
Power Supply Module	AS-PS02	100 ~ 240 V _{AC}	24 V _{DC} , 2 A (for modules on the rack)	CE/UL
	AS-PS02A		24 V _{DC} , 1.5 A (for modules on the rack) 24 V _{DC} , 0.5 A (for external I/O)	
	AS-PS03C ^(*) New		24 V _{DC} , 3 A (for external I/O) Built-in RS-485 (Modbus)	

*1: Please contact our distributors for release date

■ Communication Modules

Name	Model	Communication Card Installation	Power Consumption (Internal)	Specifications	Certification
Communication Extension Module	AS00SCM-A	2	0.6 W	<ul style="list-style-type: none"> RS-232/RS-422/RS-485 (with AS-F232/422/485) CANopen - Slave & RTU mode (with AS-FCOPM) Ethernet - EtherNet/IP RTU mode (with AS-FEN02) PROFINET - PROFINET RTU mode (with AS-FPFN02) 	CE/UL
DeviceNet Communication Module	AS01DNET-A	-	0.8 W	<ul style="list-style-type: none"> DeviceNet protocol Master/Slave modes RTU function 	
IO-Link Module	New AS04SIL-A (*1)		0.8 W	<ul style="list-style-type: none"> 4 channels 4.8/38.4/230.4 kbps Max. process data size: 32 bytes (channel) / 128 bytes (module) 	

*1: Please contact our distributors for release date

■ Digital I/O Modules

Name	Model	I/O	Signals	Terminal Block Type	Power Consumption (Internal)	Certification
Input Module	AS08AM10N-A	8	24 V _{DC} 5 mA	Removable terminal block	0.5 W	CE/UL
	AS16AM10N-A	16			0.5 W	
	AS32AM10N-A	32		MIL	0.48 W	
	AS64AM10N-A	64			0.72 W	

Name	Model	I/O	Signals	Terminal Block Type	Power Consumption (Internal)	Specifications	Certification
Output Module	AS08AN01R-A	8	240 V _{AC}	Removable terminal block	1.7 W	Relay	CE/UL
	AS16AN01R-A	16	24 V _{DC}		3.4 W	Relay	
	AS08AN01T-A	8	5 ~ 30 V _{DC} 0.5 A		0.72 W	Transistor NPN (Sink)	
	AS08AN01P-A	8			1.4 W	Transistor PNP (Source)	
	AS16AN01T-A	16		1.4 W	Transistor NPN (Sink)		
	AS16AN01P-A	16		1.4 W	Transistor PNP (Source)		
	AS32AN02T-A	32	5 ~ 30 V _{DC}	MIL	0.72 W	Transistor NPN (Sink)	
	AS64AN02T-A	64	0.1 A		1.44 W	Transistor NPN (Sink)	

Name	Model	I/O	Signals		Terminal Block Type	Power Consumption (Internal)	Specifications	Certification
			Input	Output				
Input/Output Module	AS16AP11R-A	16 (8 inputs / 8 outputs)	24 V _{DC} 5 mA	240 V _{AC} 24 V _{DC} 2 A	Removable terminal block	1.9 W	Relay	CE/UL
	AS16AP11T-A	16 (8 inputs / 8 outputs)		5 ~ 30 V _{DC} 0.5 A		0.7 W	Transistor NPN (Sink)	
	AS16AP11P-A	16 (8 inputs / 8 outputs)				0.7 W	Transistor PNP (Source)	

Ordering Information

■ Analog I/O Modules

Name	Model	Channel	Mode	Terminal Block Type	Power Consumption (Internal)	Specifications	Certification
Analog Input Module	AS04AD-A	4	1~5V 0~5V -5~5V 0~10V -10~10V 4~20mA 0~20mA -20~20mA	Removable terminal block	1.2W/2.16W	<ul style="list-style-type: none"> • Hardware resolution: 16-bit • Single channel on/off setting to enhance overall conversion efficiency • Conversion time: 2ms/channel • Disconnection detection mode: 1~5V/4~20mA 	CE/UL
	AS08AD-B	8	1~5V 0~5V -5~5V 0~10V -10~10V		1.2W/2.5W		
	AS08AD-C		4~20mA 0~20mA -20~20mA				
Analog Output Module	AS04DA-A	4	0~10V -10~10V 4~20mA 0~20mA		1.2W/2.64W	<ul style="list-style-type: none"> • Hardware resolution: 12-bit • Single channel on/off setting • Conversion time: 250µs/channel 	
Analog Input/Output Module	AS06XA-A	Input: 4 Output: 2	<ul style="list-style-type: none"> • Input: 1~5V, 0~5V, -5~5V, 0~10V, -10~10V, 4~20mA, 0~20mA, -20~20mA • Output: 0~10V, -10~10V, 4~20mA, 0~20mA 		1.2W/2.16W	<ul style="list-style-type: none"> • Input resolution: 16-bit • Output resolution: 12-bit • Single channel on/off setting to enhance overall conversion efficiency • Conversion time: 2ms/channel • Disconnection detection mode: 1~5V/4~20mA 	

■ Temperature Measurement Modules

Name	Model	Channel	Mode	Terminal Block Type	Power Consumption (Internal)	Specifications	Certification
RTD Temperature Measurement Module	AS04RTD-A	4	Pt100 Ni100 Pt1000 Ni1000 JPt100	Removable terminal block	2 W/1W	<ul style="list-style-type: none"> Resolution: 0.1°C/0.1°F Conversion time: 200 ms/channel Overall accuracy: RTD: ±0.1% TC: ±0.5% Disconnection detection mode Module monitoring/setting/planning software 	CE/UL
	AS06RTD-A	6	LG-Ni1000 Cu50 Cu100 Input impedance 0 ~ 300 Ω 0 ~ 3,000 Ω				
Thermocouple Temperature Measurement Module	AS04TC-A	4	J,K,R,S, T,E,N,B -100 ~ +100 mV				
	AS08TC-A	8					

■ Load Cell Module

Name	Model	Channel	Mode	Terminal Block Type	Power Consumption (Internal)	Specifications	Certification
Load Cell Module	AS02LC-A	2	0 ~ 1 0 ~ 2 0 ~ 4 0 ~ 6 0 ~ 20 0 ~ 40 0 ~ 80 mV/V	Removable terminal block	0.75 W/3 W	<ul style="list-style-type: none"> Resolution: 24-bit for hardware (ADC), 32-bit for data output 4-wire/6-wire load cell sensor Selectable signal input ranges LCSOFT software configuration High-speed dynamic measurement 50/60Hz active filtering 	CE/UL

Ordering Information

■ Motion Modules

Name	Model	Channel	Power Consumption (Internal)	Specifications	Certification
Position Module	New AS02PU-A	2	1.5 W	<ul style="list-style-type: none"> • Differential • Output: 200 kHz x 2; Input: 200 kHz x 1 • Motion APIs 	CE/UL
	New AS04PU-A	4		<ul style="list-style-type: none"> • Open collector • Output: 100 kHz x 4 • Motion APIs 	
High-speed Counter Module	New AS02HC-A ^(*)	2	3.6 W	<ul style="list-style-type: none"> • Open collector / Differential • 200 kHz • Incremental / absolute (SSI) 	

Note 1: Please contact our distributors for release date

■ Function Cards

Name	Model	Channel	Specifications	Certification
Communication Card	AS-F232	1	Serial COM, RS-232 interface, slave/host mode	CE
	AS-F422	1	Serial COM, RS-422 interface, slave/host mode	
	AS-F485	1	Serial COM, RS-485 interface, slave/host mode	
	AS-FCOPM	1	<ul style="list-style-type: none"> • CANopen port, supports DS301, AS Series remote control or Delta servo motor control • Built-in switchable terminal resistor (120Ω) 	
	AS-FEN02	1	Ethernet port, RJ45 x2 (Switch function), supports EtherNet/IP (Adapter mode)/Modbus TCP	
	New AS-FPFN02	1	PROFINET port, RJ45 x2 (Switch function), supports PROFINET (Slave mode)	
	New AS-FOPC02 ^(*)	1	Ethernet port, RJ45 x2 (Switch function), supports OPC-UA (Server mode)/Modbus TCP	
Analog I/O Card	AS-F2AD	2	2-channel analog input 0~10V (12-bit resolution), 4~20 mA (11-bit resolution), conversion time: 3 ms/channel	
	AS-F2DA	2	2-channel analog Output 0~10V, 4~20 mA (12-bit resolution), conversion time: 2 ms/channel	

Note 1: Please contact our distributors for release date

■ Function Card Installation Description

Name	Model	Occupied slot qty.	Acceptable installation card slot		
			AS300 CPU	AS00SCM (COM mode)	AS00SCM (RTU mode)
Communication Card	AS-F232	1	Slot 1, 2	Slot 1, 2	-
	AS-F422	1	Slot 1, 2	Slot 1, 2	-
	AS-F485	1	Slot 1, 2	Slot 1, 2	-
	AS-FCOPM	1	Slot 2	Slot 2 (Slot 1 will be disabled)	Slot 2 (Slot 1 will be disabled)
	AS-FEN02	2	Slot 2 (2 slots occupied)	-	Slot 2 (2 slots occupied)
	AS-FPFN02	2	Slot 2 (2 slots occupied)	-	Slot 2 (2 slots occupied)
	AS-FOPC02	2	Slot 2 (2 slots occupied)	-	-
Analog I/O Card	AS-F2AD	1	Slot 1, 2	-	-
	AS-F2DA	1	Slot 1, 2	-	-



Ordering Information

■ Accessories

Name	Model	Descriptions	Specifications		Applicable Module
			Length	Connector / Terminal Block Type	
I/O Cable	UC-ET010-24B	I/O cable for connecting I/O modules and external terminal modules	1m	I/O extension cable (MIL connector IDC40 to IDC40) (Shielded)	AS32AM/AS64AM/AS32AN/AS64AN
	UC-ET010-24D		1m	I/O extension cable (MIL connector IDC40 to IDC20 x2) (Shielded)	AS332T/AS332P/AS324MT/AS32AM/AS64AM/AS32AN/AS64AN
	UC-ET020-24B		2m	I/O extension cable (MIL connector IDC40 to IDC40) (Shielded)	AS32AM/AS64AM/AS32AN/AS64AN
	UC-ET020-24D		2m	I/O extension cable (MIL connector IDC40 to IDC20 x2) (Shielded)	AS332T/AS332P/AS324MT/AS32AM/AS64AM/AS32AN/AS64AN
	UC-ET030-24B		3m	I/O extension cable (MIL connector IDC40 to IDC40) (Shielded)	AS32AM/AS64AM/AS32AN/AS64AN
	UC-ET030-24D		3m	I/O extension cable (MIL connector IDC40 to IDC20 x2) (Shielded)	AS332T/AS332P/AS324MT/AS32AM/AS64AM/AS32AN/AS64AN
Cables	UC-DN01Z-01A ^(*)	CANopen / DeviceNet cables	305.0m	Thick / Trunk cable	AS200 CPU AS01DNET-A TAP-CN01 TAP-CN02 TAP-CN03
	UC-DN01Z-02A ^(*)		305.0m	Thin / Drop cable	
	UC-CMC003-01A	CANopen / DeviceNet / DMCNET cables	0.3m	RJ45	
	UC-CMC005-01A		0.5m	RJ45	
	UC-CMC010-01A		1.0m	RJ45	
	UC-CMC015-01A		1.5m	RJ45	
	UC-CMC020-01A		2.0m	RJ45	
	UC-CMC030-01A		3.0m	RJ45	
	UC-CMC050-01A		5.0m	RJ45	
	UC-CMC100-01A		10.0m	RJ45	
	UC-CMC200-01A		20.0m	RJ45	

Note:

- Ordering unit: meter
- Not available in Taiwan

■ Accessories

Name	Model	Descriptions	Specifications		Applicable Module
			Length	Connector / Terminal Block Type	
External terminal module	UB-10-ID16A	External terminal modules for digital modules	--	16 inputs or outputs (MIL connector, 20 Pins)	AS332T / AS332P / AS324MT / AS32AM / 64AM / AS32AN / AS64AN
	UB-10-ID32A			32 inputs (MIL connector, 40 Pins)	AS32AM / AS64AM
	UB-10-OT32A			32 transistor outputs (MIL connector, for NPN output)	AS32AN / AS64AN
	UB-10-OR16A			16 relay outputs (MIL connector, for NPN output)	AS332T / AS32AN02T / AS64AN02T
	UB-10-OR16B			16 relay outputs (MIL connector, for PNP output)	AS332P
	UB-10-IO32D			Connector converter (MIL → Spring) <small>(Can NOT be installed on two consecutive high-density modules)</small>	AS332T / AS332P / AS324MT / AS32AM / AS32AN
Terminal resistors	TAP-TR01	CANopen / DeviceNet terminal resistors (RJ45)			
Distribution box	TAP-CP01	CANopen / DeviceNet distribution box	--	Power distribution box	
	TAP-CN01		--	1 for 2	
	TAP-CN02		--	1 for 4	
	TAP-CN03		--	1 for 4 (RJ45)	
Auxiliary connected power module	AS-ATXB	Moves the CPU power connector from left side to the bottom			
PLC programming cable	UC-PRG015-01A	Communication cable: PLC to PC	1.5 m	PLC (mini USB)	
	UC-PRG030-01A		3 m	PLC (mini USB)	
	UC-PRG030-20A	Communication cable: PLC / HMI (RJ45) to PC	3 m	PLC / HMI (RJ45)	

■ Starter Kit

Name	Model	Specifications
Delta PLC starter kit	UT-AS332-C	AS332T-A CPU, a power module and accessories



Smarter. Greener. Together.

Industrial Automation Headquarters

Taiwan: Delta Electronics, Inc.

Taoyuan Technology Center
No.18, Xinglong Rd., Taoyuan District,
Taoyuan City 33068, Taiwan
TEL: +886-3-362-6301 / FAX: +886-3-371-6301

Asia

China: Delta Electronics (Shanghai) Co., Ltd.

No.182 Minyu Rd., Pudong Shanghai, P.R.C.
Post code : 201209
TEL: +86-21-6872-3988 / FAX: +86-21-6872-3996
Customer Service: 400-820-9595

Japan: Delta Electronics (Japan), Inc.

Industrial Automation Sales Department
2-1-14 Shibadaimon, Minato-ku
Tokyo, Japan 105-0012
TEL: +81-3-5733-1155 / FAX: +81-3-5733-1255

Korea: Delta Electronics (Korea), Inc.

1511, 219, Gasan Digital 1-Ro., Geumcheon-gu,
Seoul, 08501 South Korea
TEL: +82-2-515-5305 / FAX: +82-2-515-5302

Singapore: Delta Energy Systems (Singapore) Pte Ltd.

4 Kaki Bukit Avenue 1, #05-04, Singapore 417939
TEL: +65-6747-5155 / FAX: +65-6744-9228

India: Delta Electronics (India) Pvt. Ltd.

Plot No.43, Sector 35, HSIIDC Gurgaon,
PIN 122001, Haryana, India
TEL: +91-124-4874900 / FAX: +91-124-4874945

Thailand: Delta Electronics (Thailand) PCL.

909 Soi 9, Moo 4, Bangpoo Industrial Estate (E.P.Z),
Pattana 1 Rd., T.Phraksa, A.Muang,
Samutprakarn 10280, Thailand
TEL: +66-2709-2800 / FAX: +66-2709-2827

Australia: Delta Electronics (Australia) Pty Ltd.

Unit 2, Building A, 18-24 Ricketts Road,
Mount Waverley, Victoria 3149 Australia
Mail: IA.au@deltaww.com
TEL: +61-1300-335-823 / +61-3-9543-3720

Americas

USA: Delta Electronics (Americas) Ltd.

5101 Davis Drive, Research Triangle Park, NC 27709, U.S.A.
TEL: +1-919-767-3813 / FAX: +1-919-767-3969

Brazil: Delta Electronics Brazil Ltd.

Estrada Velha Rio-São Paulo, 5300 Eugênio de
Melo - São José dos Campos CEP: 12247-004 - SP - Brazil
TEL: +55-12-3932-2300 / FAX: +55-12-3932-237

Mexico: Delta Electronics International Mexico S.A. de C.V.

Gustavo Baz No. 309 Edificio E PB 103
Colonia La Loma, CP 54060
Tlalnepantla, Estado de México
TEL: +52-55-3603-9200

EMEA

EMEA Headquarters: Delta Electronics (Netherlands) B.V.

Sales: Sales.IA.EMEA@deltaww.com
Marketing: Marketing.IA.EMEA@deltaww.com
Technical Support: iatechnicalsupport@deltaww.com
Customer Support: Customer-Support@deltaww.com
Service: Service.IA.emea@deltaww.com
TEL: +31(0)40 800 3900

BENELUX: Delta Electronics (Netherlands) B.V.

Automotive Campus 260, 5708 JZ Helmond, The Netherlands
Mail: Sales.IA.Benelux@deltaww.com
TEL: +31(0)40 800 3900

DACH: Delta Electronics (Netherlands) B.V.

Coesterweg 45, D-59494 Soest, Germany
Mail: Sales.IA.DACH@deltaww.com
TEL: +49(0)2921 987 0

France: Delta Electronics (France) S.A.

ZI du bois Challand 2, 15 rue des Pyrénées,
Lisses, 91090 Evry Cedex, France
Mail: Sales.IA.FR@deltaww.com
TEL: +33(0)1 69 77 82 60

Iberia: Delta Electronics Solutions (Spain) S.L.U

Ctra. De Villaverde a Vallecas, 265 1º Dcha Ed.
Hormigueras – P.I. de Vallecas 28031 Madrid
TEL: +34(0)91 223 74 20

Carrer Llacuna 166, 08018 Barcelona, Spain

Mail: Sales.IA.Iberia@deltaww.com

Italy: Delta Electronics (Italy) S.r.l.

Via Meda 2-22060 Novedrate(CO)
Piazza Grazioli 18 00186 Roma Italy
Mail: Sales.IA.Italy@deltaww.com
TEL: +39 039 8900365

Russia: Delta Energy System LLC

Vereyskaya Plaza II, office 112 Vereyskaya str.
17 121357 Moscow Russia
Mail: Sales.IA.RU@deltaww.com
TEL: +7 495 644 3240

Turkey: Delta Greentech Elektronik San. Ltd. Sti. (Turkey)

Şerifali Mah. Hendem Cad. Kule Sok. No:16-A
34775 Ümraniye – İstanbul
Mail: Sales.IA.Turkey@deltaww.com
TEL: + 90 216 499 9910

MEA: Eltek Dubai (Eltek MEA DMCC)

OFFICE 2504, 25th Floor, Saba Tower 1,
Jumeirah Lakes Towers, Dubai, UAE
Mail: Sales.IA.MEA@deltaww.com
TEL: +971(0)4 2690148

*We reserve the right to change the information in this catalogue without prior notice.