



Care
222[®]
by Ushio

Delta U⁺ Far-UVC Light Care 222[®] Series

Fast disinfection, effective protection

The new Delta U⁺ Far-UVC Light Care 222[®] Series employs the Care 222[®] technology from Ushio, a Japanese leader in special light-source technologies, as the best UV disinfection solution. Featuring contact and residuals free sterilization, the series serves as a more effective disinfectant than alcohol by inactivating viruses and bacteria on the surface of objects and in the air, thus delivering better performance for pandemic prevention. In fact, it has been proven to be significantly bacteriostatic against SARS-CoV-2.

Delta U+ Far-UVC Light Care 222® Series

The Delta U+ Far-UVC Light Care 222® series is a line of UV sterilization devices that are safe for human exposure. The series offers a wide range of products in various styles for different spaces and applications such as hospitals, banks, factories, store entrances/exits, waiting rooms, elevators, car interiors, and more.

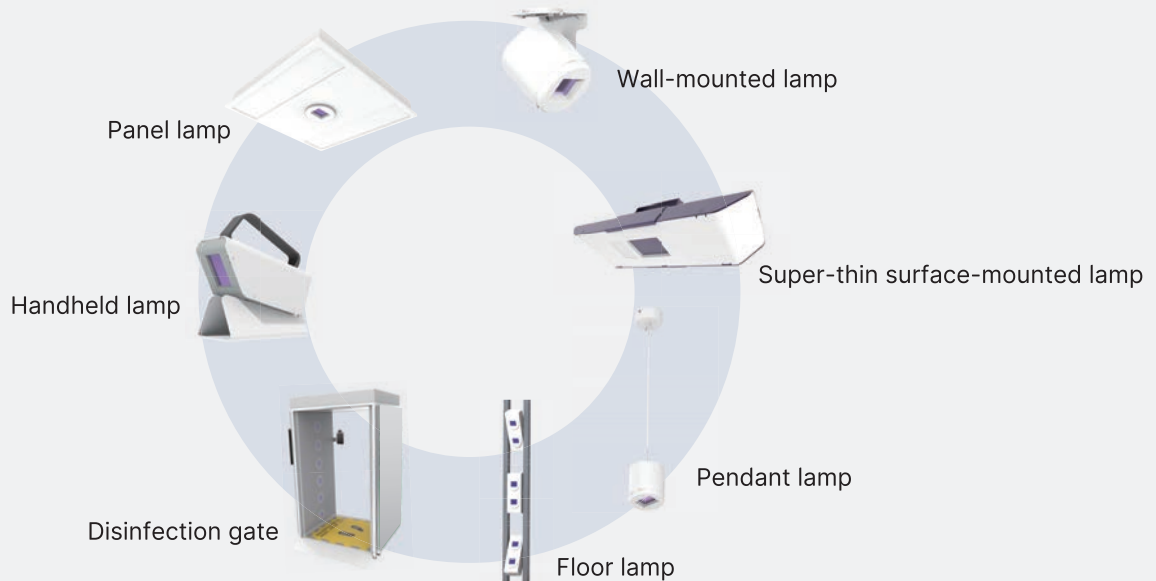

Conditions for germicidal irradiation

(can kill 99% of bacteria, molds, and viruses)

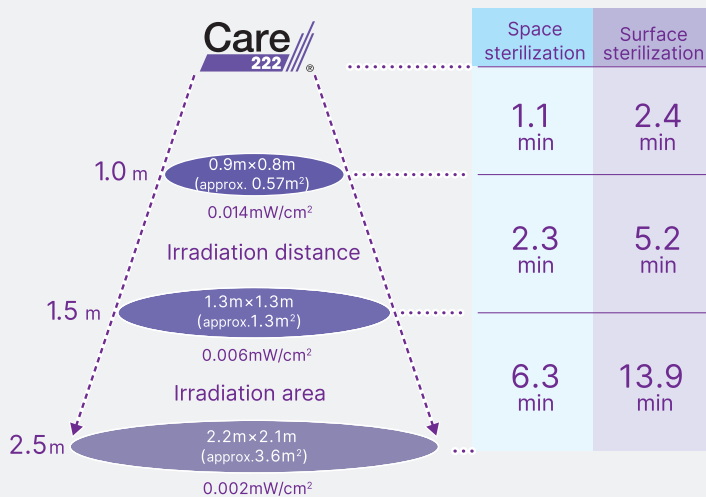

Safety precautions

* The Threshold Limit Value (TLV) of an ultraviolet light exposure dose at 222nm for a person is 478mJ/cm² or less a day (within 8 hours a day).

* As with other lighting fixtures, avoid looking directly at the Care222® fixtures at close range (as it may irritate the eyes).

* Users who are allergic to light or are pregnant should take regular UV light protection measures as a daily precaution.

Sources: ACGIH (the American Conference of Governmental Industrial Hygienists) and JIS Z 8812 (Japanese Industrial Standards: Measuring Methods of Eye-Hazardous Ultraviolet Radiation)

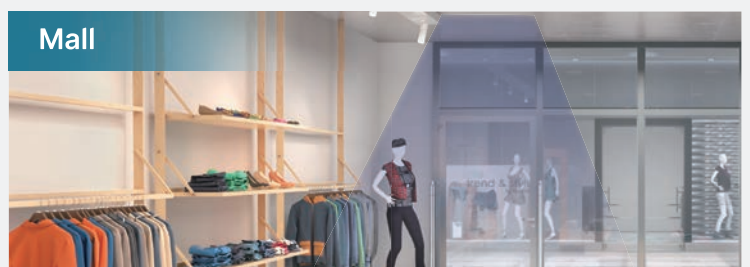

A Safe UV Light Disinfection Solution

Care 222[®] is a light source module that can inactivate bacteria and viruses with ultraviolet light emitted at the wavelength of 222nm. The 254nm wavelength ultraviolet rays commonly used are easily absorbed by DNA, which is bacteriostatic indeed, but it also exerts an adverse impact on human cells. The special, shorter wavelength of UV-C 222nm light, in contrast, is germicidal as it penetrates the DNA of viruses and bacteria. However, when irradiated on people, 222nm light will be absorbed by the stratum corneum of our skin before reaching the DNA of human cells. Conversely, longer wavelength of 254nm ultraviolet rays can penetrate the layers of our skin and cause damage to the DNA in our skin cells.

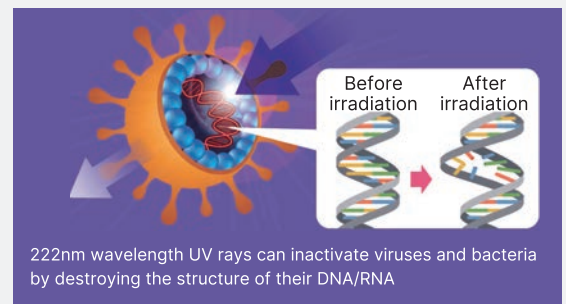
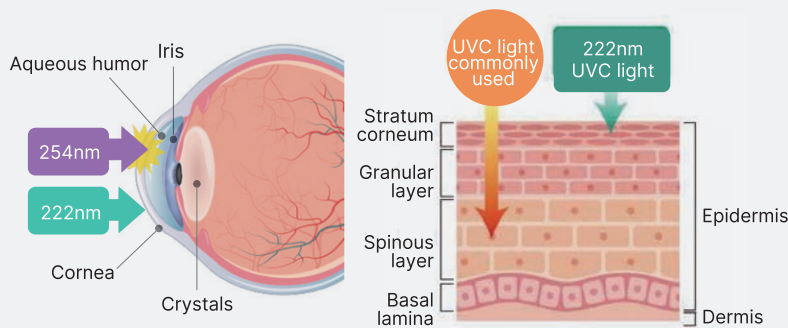

222nm wavelength UV rays can inactivate viruses and bacteria by destroying the structure of their DNA/RNA

Source: Oshio

Germicidal features of Care 222[®] when compared with UV rays at 254nm wavelength

Domain	Species	Dose for 99.9% [mJ/cm ²]	
		222nm	254nm
Vegetative Bacteria	MRSA (Methicillin-Resistant Staphylococcus Aureus)	15	10
	<i>Pseudomonas aeruginosa</i>	8	4
	<i>Escherichia coli</i> O157	9	5
	<i>Salmonella typhimurium</i>	10	4
	<i>Campylobacter jejuni</i>	4	4
	<i>Bacillus subtilis</i> (Vegetative cell)	7	8
	<i>Bacillus cereus</i> (Spore)	44	90
Molds and Yeasts	<i>Bacillus subtilis</i> (spore)	30	60
	<i>Clostridium difficile</i>	30	60
	<i>Candida albicans</i>	24	40
	<i>Penicillium expansum</i>	50	50
Virus	<i>Aspergillus niger</i> (Spore)	>1000	>700
	<i>MS2</i> (Bacteriophage)	23	50
	<i>Feline calicivirus</i>	24	24
	<i>Influenza virus</i>	6	6
	<i>Covid-19</i> (coronavirus)	3	5

Table. Inactivation effect of 222nm, 254nm UVC irradiation on the species. Dose of UVC radiation to achieve 3-log reduction of the species. Prepared by Lecture on Infective Biological Defense, Graduate School of Medicine, Hirosaki University

Care 222[®] is a good disinfectant against bacillus

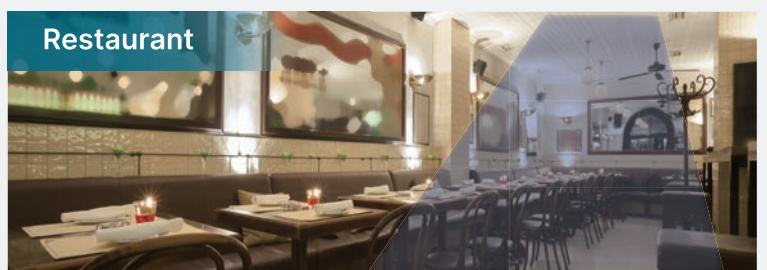

Clinic

With visitors constantly accessing, medical facilities require frequent and heavy cleaning. The U+ Far-UVC Light Care 222® series can assist in continuously inhibiting bacteria, keeping the environment clean, and reducing the burden of the cleaning and disinfection crew.



U+ Pendants Disinfection Lamp

BA-U22C112U0000MZ

1



Light source	USHIO Care222 
wavelength	222nm ultraviolet
Power consumption	15W
Input voltage	100-240 Vac 50/60 Hz
Dimension	ø 12.7 x 13.4 cm
Weight	1.2 Kg
Warranty	3 years
Operation mode	- Duty-cycle operation after power is switched on - Operation status is displayed by LEDs

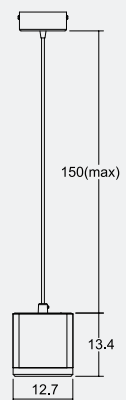

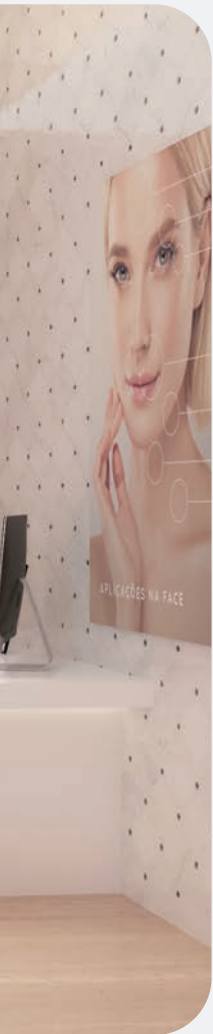



U+ Panel Disinfection Lamp

BA-U223C45U8857MZ

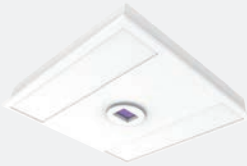
2



Light source	USHIO Care222 
Wavelength	222nm ultraviolet
Power consumption	45W
Input voltage	100-240 Vac 50/60 Hz
Dimension	60 x 60 x 8 cm
Weight	5 Kg
Warranty	3 years
Operation mode	- Duty-cycle operation after power is switched on - Operation status is displayed by LEDs

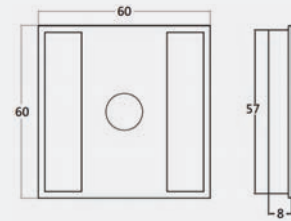

U+ Wall-mounted Disinfection Lamp

BA-U222015U1000MZ

3



Light source	USHIO Care222 
Wavelength	222nm ultraviolet
Power consumption	15W
Input voltage	100-240 Vac 50/60 Hz
Dimension	18 x 14 x 14 cm
Weight	1.5 Kg
Warranty	3 years
Operation mode	- Duty-cycle operation after power is switched on - Operation status is displayed by LEDs

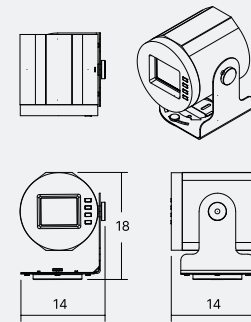

U+ Handheld Disinfection Lamp

BA-U228015F1000TZ

4



Light source	USHIO Care222 
Wavelength	222nm ultraviolet
Power consumption	15W
Power source	Lithium battery (about 1.5hr continuous operation)
Dimension	19 x 16 x 10 cm
Weight	1 Kg
Warranty	1 year
Operation mode	press and run

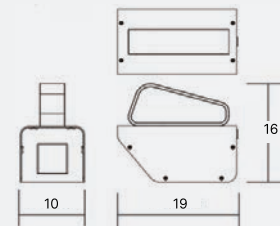

Entrance/Exit

To exercise anti-pandemic control over large spaces, disinfection gates are ideal for disinfecting the flow of people. The device can also work with body temperature monitoring or face recognition systems to serve multiple purposes.



Store entrance

A large number of people enter and exit shops and restaurants through entrances, but the space of those places is limited. Floor-type disinfection lamps can be flexibly set up to accommodate store space conditions to ensure that users can receive antibacterial protection upon entering/exiting.



Elevator

With limited space to accommodate many people, it is difficult to maintain proper social distance in the elevator. Wall-mounted disinfection lamps are specifically designed for elevator space. Once the elevator is occupied, the lamp will activate immediately and perform cyclic antibacterial protection for elevator users.



U+ Disinfection Gate

BA-U2260A5U0000MZ



Light source	USHIO Care222 
Wavelength	222nm ultraviolet
Power consumption	260W
Input voltage	110VAC/220VAC (Select via switch)
Dimension	116 x 145 x 236 cm
Weight	250 Kg
Accessories	Temperature sensor bracket
Operation mode	- Motion sensor for automatic operation - Continuous motion sensor trigger function

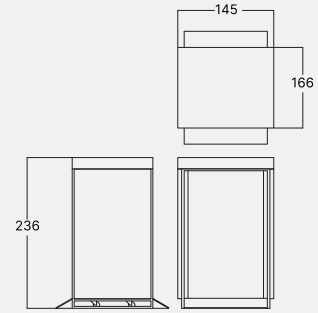

* The product starts operating after 10-second warmup time when switched on

U+ Floor Disinfection Lamp

BA-U2260A0U1000MZ



Light source	USHIO Care222 
Wavelength	222nm ultraviolet
Power consumption	100W
Input voltage	110VAC/220VAC (Select via switch)
Dimension	192 x Ø40 cm
Weight	27 Kg
Warranty	3 years
Operation mode	- Motion sensor for automatic operation - Continuous motion sensor trigger function

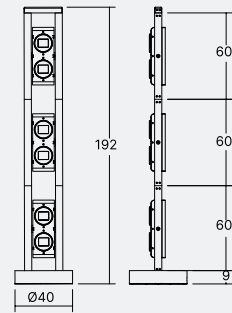

U+ Superthin Surface-mounted Disinfection Lamp

BA-U22C015U1000MZ



Light source	USHIO Care222 
Wavelength	222nm ultraviolet
Power consumption	15W
Input voltage	100-240Vac
Dimension	34 x 5 x 11 cm
Weight	1.2 Kg
Warranty	3 years
Operation mode	- Automatic cyclic operation - Operation status is displayed by LEDs

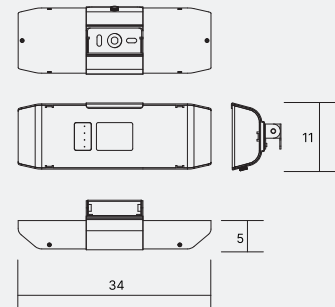

Delta Global Operations



169 Global sales offices

38 Global plant sites

64 Global R&D centers



Delta Electronics (Netherlands) B.V.

Zandsteen 15, 2132 MZ Hoofddorp, The Netherlands

TEL : +31-20-655-0900

FAX : +31-20-655-0999

Email: sleu@deltaww.com



buildings.deltaww.com

UV_SterilizationDevice_en_202201

All specifications are subject to change without notice.
Copyright © Delta Electronics, Inc. All rights reserved.