



The power behind competitiveness

Delta Data Collector

PPM DC1_100

Operation and Installation Manual

Contents

■Introduction■

Precautions for Your Safety	04
Essential Points for Safety	06
Precautions for Use	06
1. Preparation before construction	07
1.1.Scope of Delivery	07
1.2.Dimension	08
1.3.Descriptions and Functions of Parts and Components	09
2. Installation (Wired)	10
2.1.Installation on wall	10
2.2.Installation in box (outdoor)	11
2.3.Setting Connectors and Cables	12
2.4.RS-485 (Connection to the inverter)	13
3. Supported inverter models	14
3.1.Normal mode	14
3.2.Retrofit mode	14
4. Commissioning	15
4.1.First startup	15
4.2.Home Page (APP)	21
4.3.Operation Screens	22
4.4.Reset Method	23
5. DC1 mode setting process	24
5.1.Normal mode (RS-485)	24
5.2.Normal mode (Wi-Fi)	25
5.3.Retrofit mode (Sub_1G)	26
5.4.Retrofit mode	30
5.5.3rd party monitoring	32
6. Description of the page display (APP)	34
6.1.Energy	34
6.2.Infomation	35
6.3.History	35
6.4.Connection	36
6.5.Grid Setting	36
6.6.Network	37
6.7.FW Update	38
6.8.OTHER	40
7. Description of the page display (Cloud)	41
7.1.Home Page	41
7.2.MY SOLAR	42
7.3.Products	44
7.4.Contact Us	45
7.5.Edit Password	45
8. When Something Seems Wrong (Troubleshooting)	46
8.1.Error Displays	46
8.2.Troubleshooting	47
8.3.Error dialog display	48
9. Specifications	50
Appendix - N1	51
Appendix - N2	53



Precautions for Your Safety

■ Notations for safe use of the product and their meanings





This Instruction Manual provides precautions with the following notations and symbols for safe use of the PPM DC1_100. The expression “Product”, “Data Collector” or “DC1” refers to the PPM DC1_100. Precautions described herein contain important aspects of safety.

Please observe and follow these descriptions.

Notations and symbols are described below:

 <b style="font-size: 1.2em;">Warning	<p>Failing to handle the Product properly may result in the described danger leading to slight or intermediate level injuries and in some cases may also result in serious injury or death.</p>
 <b style="font-size: 1.2em;">Caution	<p>Failing to handle the Product properly may result in the described danger leading to slight or intermediate level injuries or property damages in some instances.</p>

■ Explanation of graphic symbols

	<ul style="list-style-type: none"> ● Electric Shock Precaution <p>Notifications pertaining to precautions for potential electric shock, under specific conditions</p>
	<ul style="list-style-type: none"> ● General <p>Unspecified general notifications pertaining to prohibited actions.</p>
	<ul style="list-style-type: none"> ● Disassembly prohibited <p>Notifications pertaining to prohibition of equipment disassembly, when doing so can potentially lead to injuries such as electric shock.</p>
	<ul style="list-style-type: none"> ● General <p>Unspecified general notifications pertaining to instructions for users</p>

Warning

Do not allow any fire producing objects to be near the Product, or apply any spray, including combustible gases, to the Product. The Product may ignite or explode in the unlikely event such an occurrence takes place.



Do not touch the Product with wet hands.
The Product may cause injury due to electric shock or equipment malfunction may occur in the unlikely event such an occurrence takes place.



Do not disassemble or modify the Product.
The Product may cause injury or fire due to electric shock in the unlikely event such an occurrence takes place.



When wiring the power meter, make sure to turn OFF the breakers connected to the power meter. Although small, there is a risk of electric shock.



When installing the DC1, make sure to turn OFF all solar generator breakers and direct current switches for the inverter.
Although small, there is a risk of electric shock.



Caution

Do not install the Product in a place that is subject to significant effects of vibration and impact. There is danger of injury from the Product falling in some rare cases.



Do not use organic solvents (paint thinners, benzene and the like), strong alkaline substances or strong acidic substances to clean the case of the product. There is danger of discoloring the case or the equipment malfunctioning in some rare cases.



When installing the DC1 on a wall made of materials that are not wood, be sure to acquire plastic anchors available on the market to secure the Wall Surface Mounting Plate on the wall surface. There is danger of injury from the Product falling in some rare cases.



Securely tighten the screws using a torque of 0.98 N.m.
Although small, there is a risk of burns due to defective connections.
Do not tighten the wiring using electric tools (drills), whose main purpose is to open holes, such as impact drivers, etc.



Do not install the Product in the following types of locations:
There is danger of burnout in some rare cases.

- Locations that are exposed to rain water, such as outdoors or under eaves and the like.
- Locations that are exposed to steam or where the moisture level is 30 to 85% RH, such as lavatories, changing rooms, work sites, kitchens and the like.



Essential Points for Safety

Items described below must be followed as they are necessary to secure safety.

- Request a specialist to dispose of the product.
- Pull 16-pin terminal and Power supply terminal off when any abnormality is detected like smoke, heat.
- Install the product with the “DELTA” logo facing front when installing the Data Collector on a wall.
- Take care to ensure no water or other liquid gets on the Data Collector.
- The product may malfunction or may be damaged by static electricity. Be sure to remove any static electricity on the body, through such means as touching a metal object nearby, prior to coming into contact with the product.
- Do not connect a telephone line to the LAN terminal on the Data Collector, make sure Ethernet cable is used.
- Store the product in a location with the temperature ranging between -30 and +70°C, with the humidity ranging from 30 to 85% RH.
- Max. 32 inverters can be monitored through RS-485 at one time.
Max. 9 inverters can be monitored through Wi-Fi at one time.

Do not install the product in the following places:

- Do not expose to extreme fluctuation temperature.
- Do not expose to salt air.
- Do not expose to corrosive substances, explosive / flammable GAS, chemicals.
- Do not install in direct sunlight.
- Do not install in a place exceeding the operating temperature range (-25 to +55°C).
- Do not install above 2000m MSL or higher.
- Do not expose to water vapor, oil vapor, smoke, cotton dust, metal powder, sawdust.

※If installed outdoor, please put it in box which is suitable for outdoor use.







Precautions for Use

- The Product may malfunction or may be damaged by static electricity. Be sure to remove any static electricity on the body, through such means as touching a metal object nearby, prior to coming into contact with the Product.
- Store the Product in a location with the temperature ranging between -20 and +55°C, with the humidity ranging from 30 to 85% RH.
- The Product communicates wirelessly.
Install the Product as far away as possible from devices that emit strong radio waves, such as a civil band radio equipment.
- The communication performance varies depending on the peripheral environment. Verify in advance that the Product is communicating normally when installing the Data Collector on a wall.
- Avoid installing the Data Collector near iron plate or steel reinforcements and try to install the Product with as much clear space as possible.

1.Preparation before construction

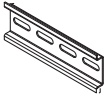
1.1.Scope of Delivery

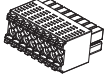
Verify that following items are available for use prior to using this feature.

NO.	Product name	Qty	Remarks	Shape
1	Data Collector	1 unit	Main unit	
2	Wi-Fi Antenna	1 piece	Install antenna to Enhance Wireless Signals.	
3	DIN Rail	1 piece	This is a rail used to install the product on a wall.	
4	DIN Rail Screw (PH2)	3 pieces	These are wood screws for the Wall Surface.	
5	16-pin Connector	1 piece	Connect to the main unit.	
6	DIN Rail Stopper	2 pieces	Stoppers to secure the installation of Data Collector on a DIN Rail.	
7	Quick Installation Guide	1 copy	Installation Guide	

1.2.Dimension

DC1

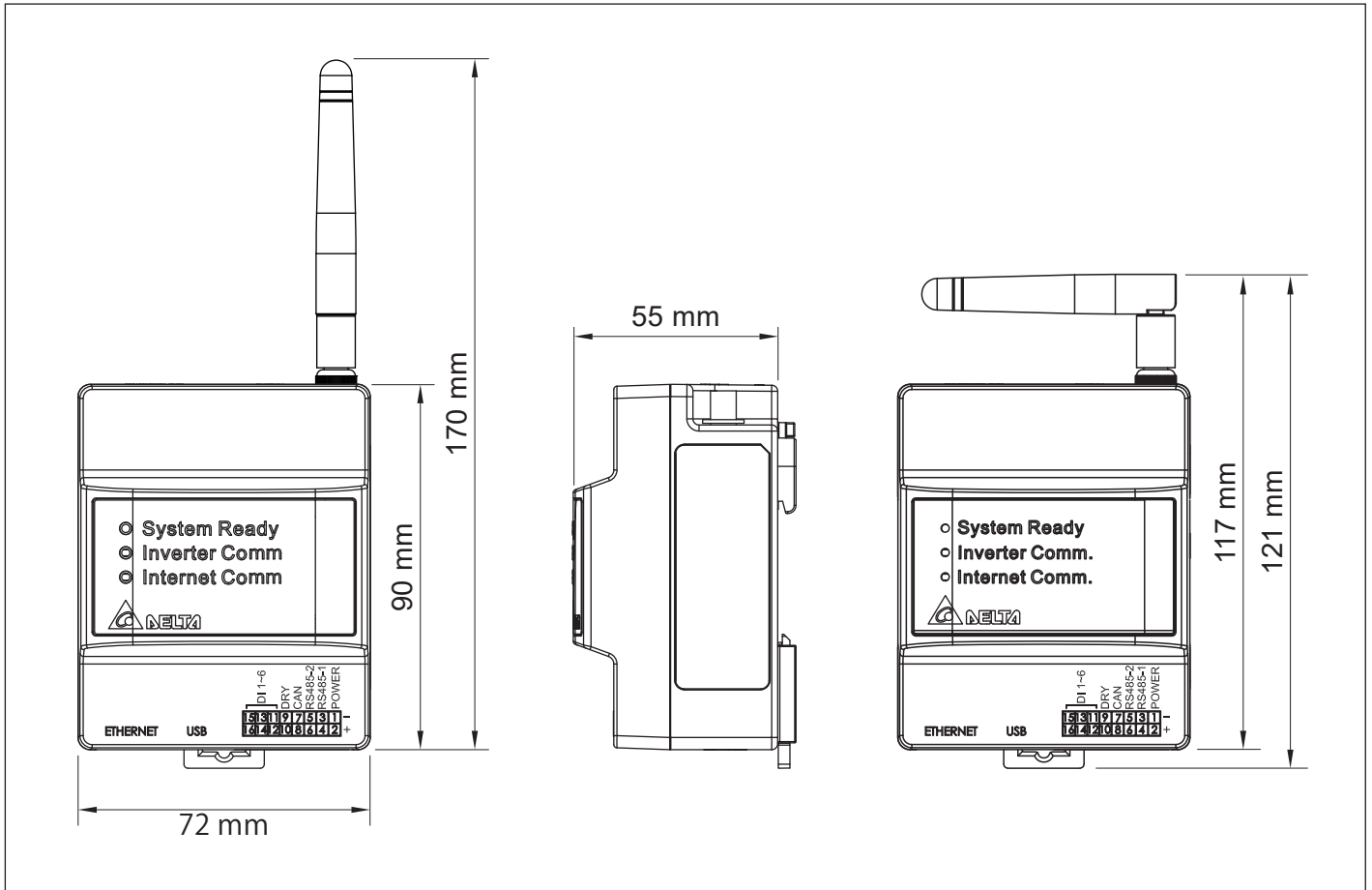

Din Rail

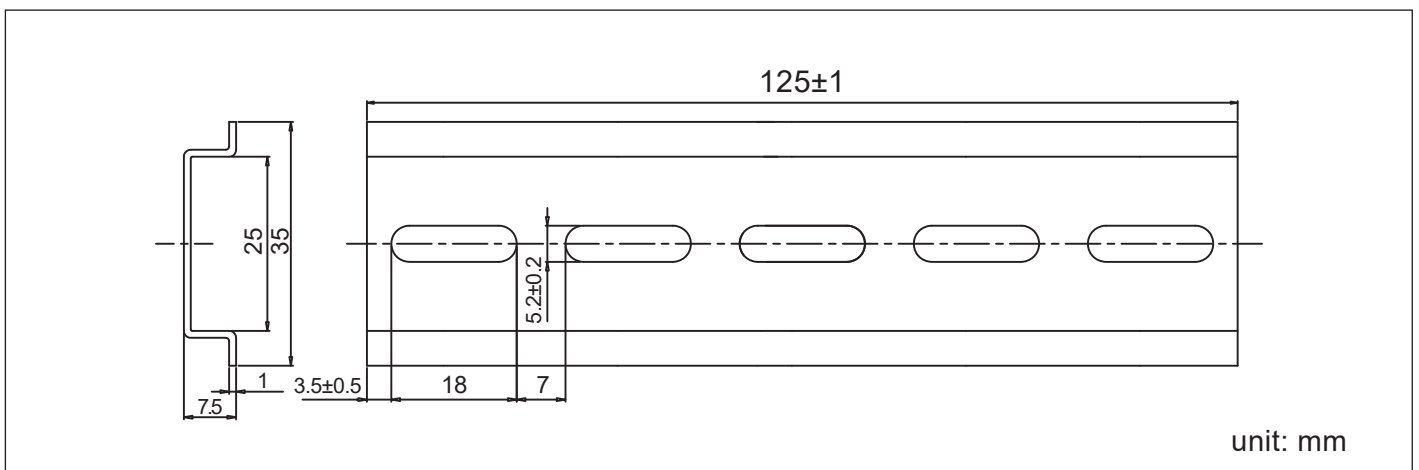

1.3. Descriptions and Functions of Parts and Components

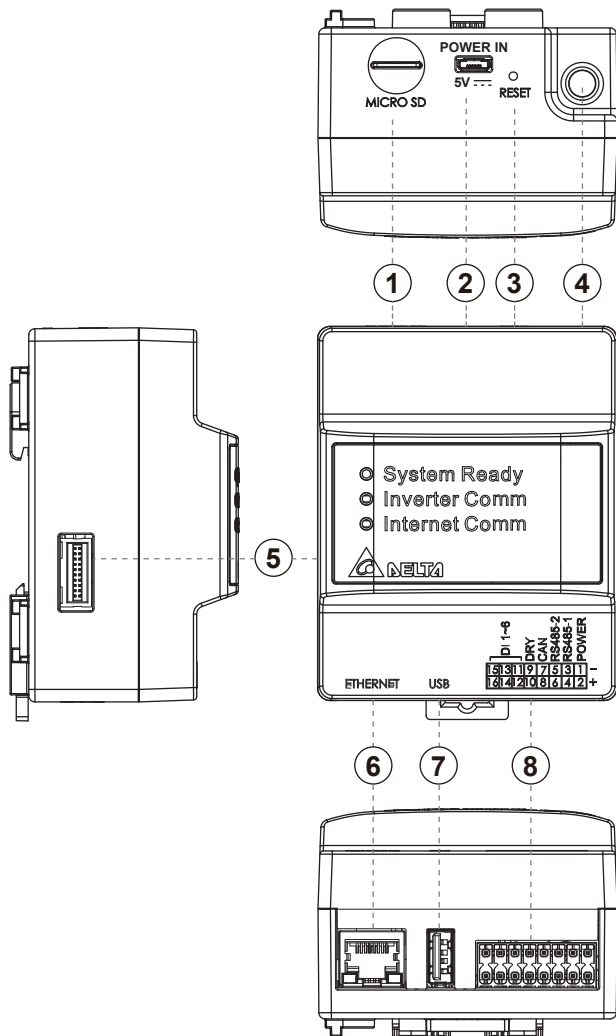

- ① MICRO SD
Use SD card to reset Data Collector to factory default.
The settings and records will be deleted.
- ② Power supply terminal
Power supply terminal of Data Collector. (Input Voltage: 5V)
- ③ Reset button
Resetting the Data Collector. Restart the Data Collector.
The settings and records will not be deleted.
- ④ Wi-Fi antenna
Install antenna to Enhance Wireless Signals.
- ⑤ Extend terminal
It is also possible to expand the matching Power Meter for measurement.
- ⑥ LAN terminal (RJ-45 terminal)
This is the terminal that is used to connect the system to an ethernet cable.
- ⑦ USB terminal (for USB)
Reserve of various data and maintenance can be performed.
* Customers are requested to procure their own USB memory.
- ⑧ RS-485 (a 16-pin terminal)
This is the terminal that is used to connect a 16-pin connector provided, to link the supply of power and signals from the Inverter.

Wi-Fi Module

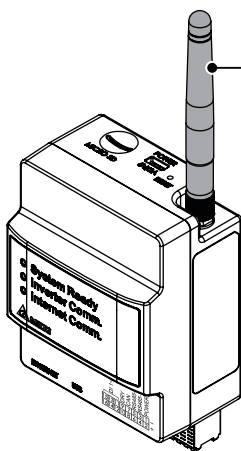

Name	Explanation
Network standard support	IEEE 802.11 b/g/n
Data rates	802.11n 6.5Mbps to 150Mbps (MCS 0-7)
	802.11g 6Mbps to 54Mbps
	802.11b 1Mbps to 11Mbps
Modulation techniques	OFDM with BPSK, QPSK, 16-QAM, 64-QAM
	802.11b with CCK and DSSS
Bandwidth	20MHz/ 40MHz

LED Explanation



Name	LED	Explanation
System Ready	Red	Booting.
	Green	System ready.
Inverter Comm	Green (blinking)	Searching inverters.
	Green	Inverter connected.
Internet Comm	Green	Internet connected.

2. Installation (Wired)

2.1. Installation on wall

1. DC1

- (1) Use the supplied DIN Rail and mount in distribution cabinet (A).
- (2) Fix the Data Collector on top of the DIN Rail.(B)
- (3) Buckle the Data Collector on the DIN Rail.(C)
- (4) Install two stoppers on the DIN Rail on both side of the Data Collector, then lock in the screws on stoppers to fix these stoppers on the DIN Rail.(D)

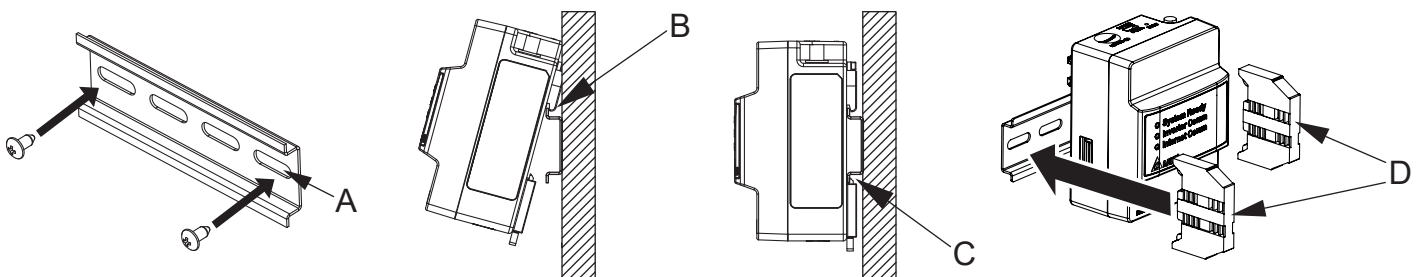

2. DC1 + N1

- (1) Use the supplied DIN Rail and mount in distribution cabinet (A).
- (2) Fix the Data Collector on top of the DIN Rail.(B)
- (3) Buckle the Data Collector on the DIN Rail.(C)
- (4) Install two stoppers on the DIN Rail on both side of the Data Collector, then lock in the screws on stoppers to fix these stoppers on the DIN Rail.(D)

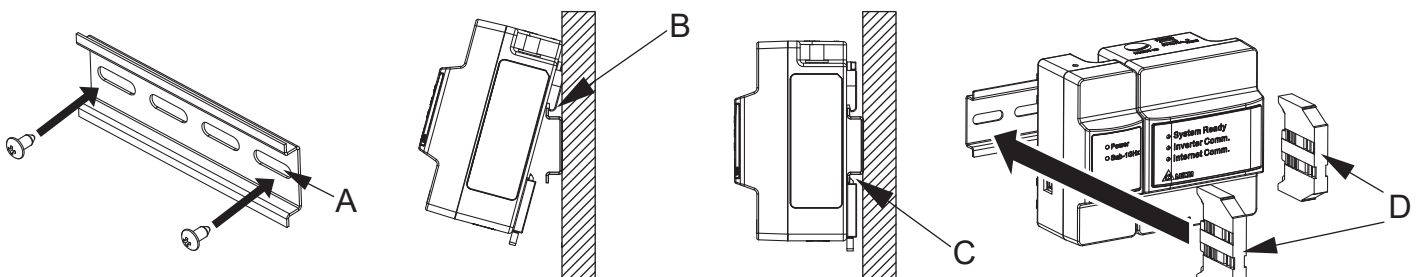

2.2. Installation in box (outdoor)

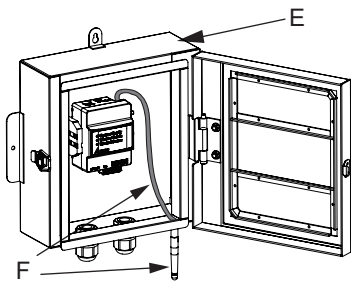

1. DC1

(1) Please prepare a protective case to protect Data Collector (E).

- * If the external box is made of plastic material, Wi-Fi antenna can be installed in the box.
- * If the external box is made of metal, Wi-Fi antenna needs to be installed outside the box (F). User needs to use extension cable to connect the Wi-Fi antenna.

(2) An external box is available for customer from Delta. Contact retailer for more details.

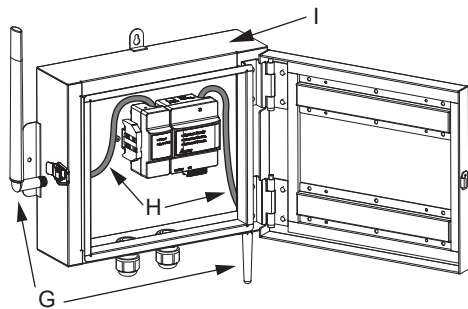
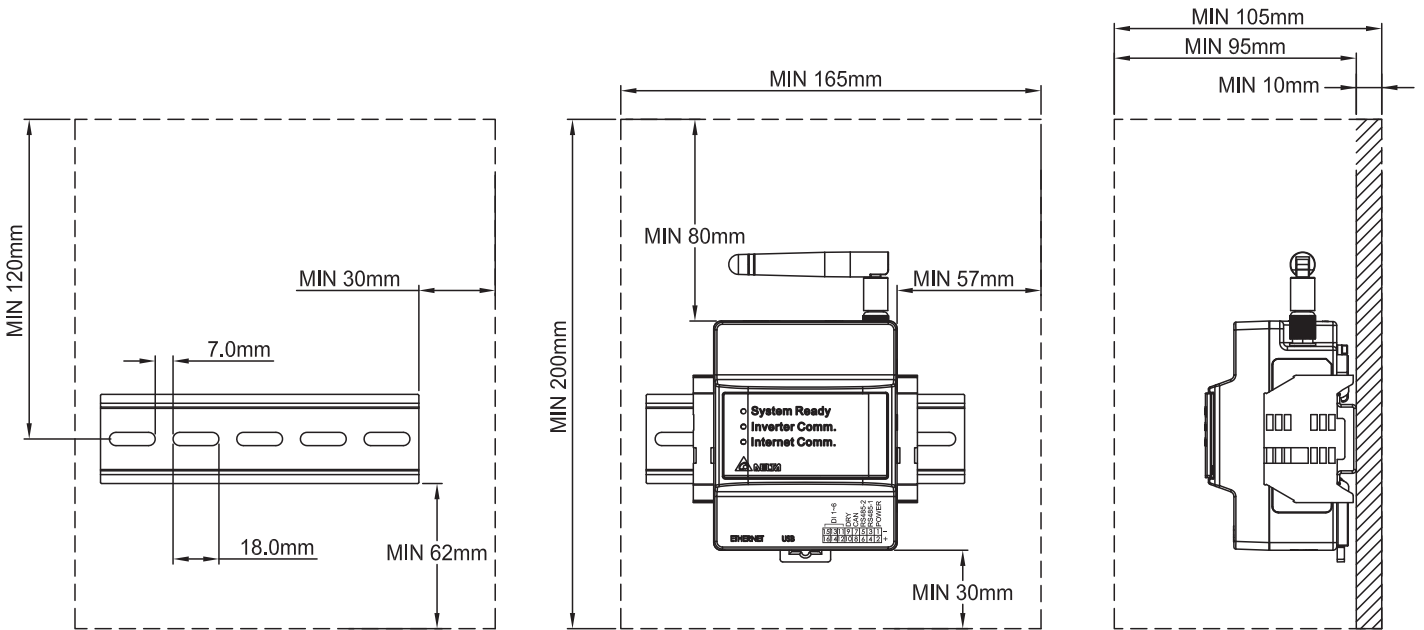

2. DC1 + N1

(1) Please prepare a protective case to protect Data Collector and Sub-1GHz module(I)

- * If the external box is made of plastic material, Wi-Fi and Sub-1G antenna can be installed in the box
- * If the external box is made of metal, Wi-Fi and Sub-1G antenna needs to be installed outside the Box (G&H)

(2) An external box is available for customer from Delta. Contact retailer for more details.

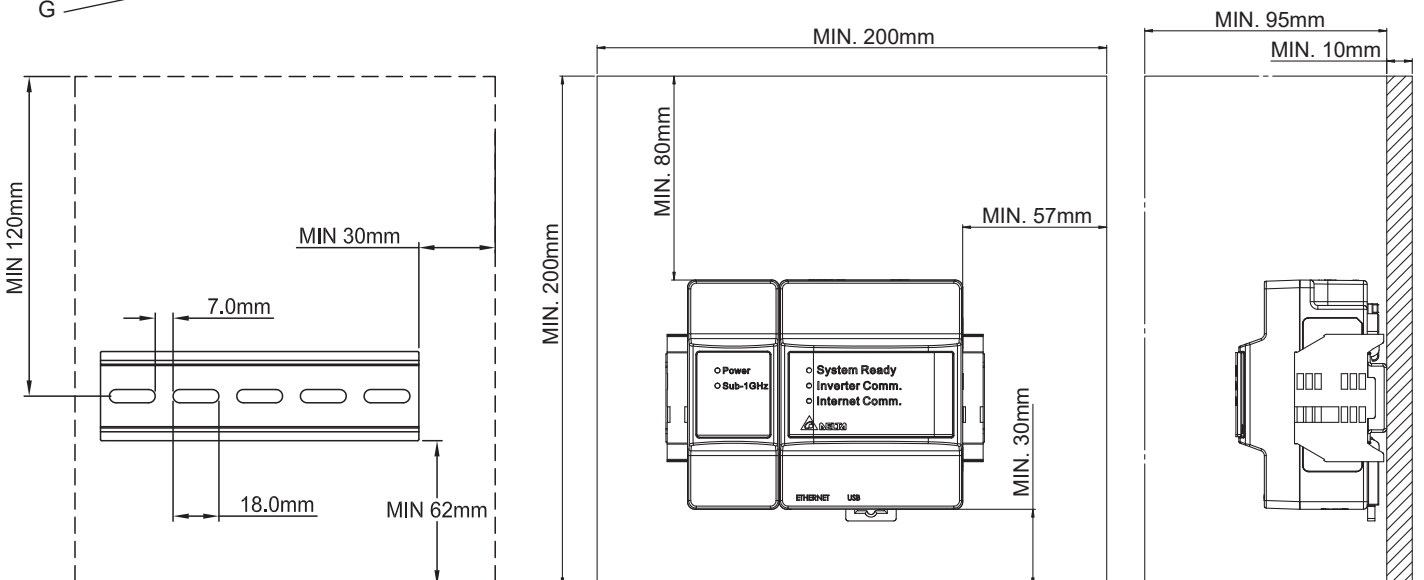

2.3. Setting Connectors and Cables

- Setting cables

Prepare 0.3 to 0.5mm² x single wire, 4 cores (twin wires) shielded cables (rated temperature: 80°C to 85°C).

* Process the cables before use.

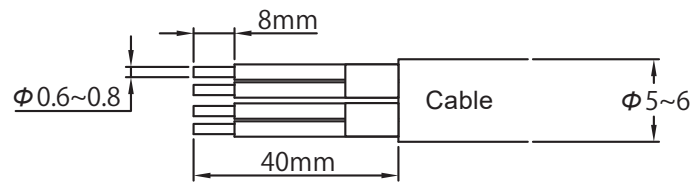

- Assemble 16-pin connector

Hold down the pin ① of 16-pin connector, insert cable and connect connector to Data Collector.

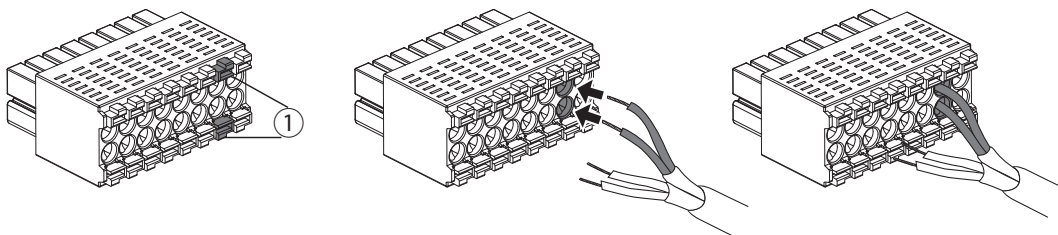

- Assemble communication connector

Hold down pin ① of connector in inverter, insert cable and connect connector to inverter.

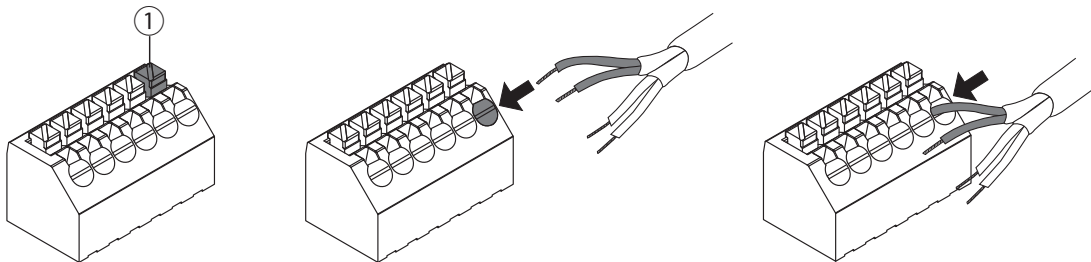

2.4.Connection to the inverter

RS-485

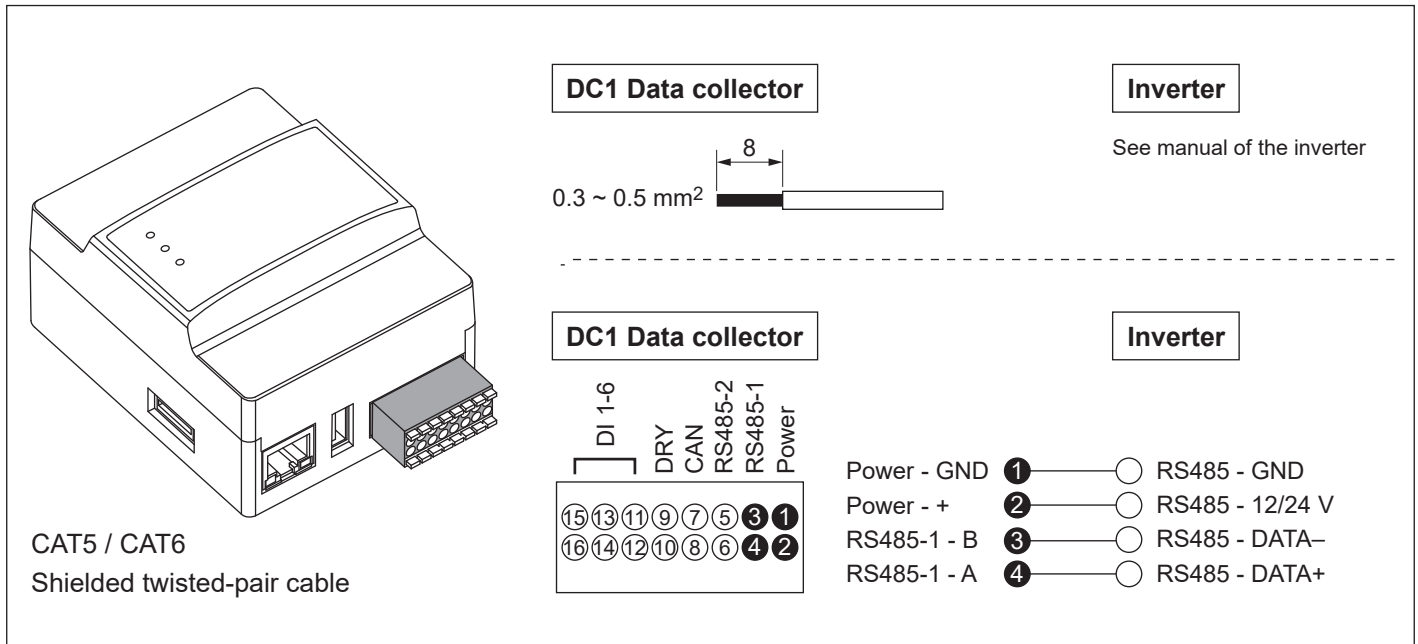

N2

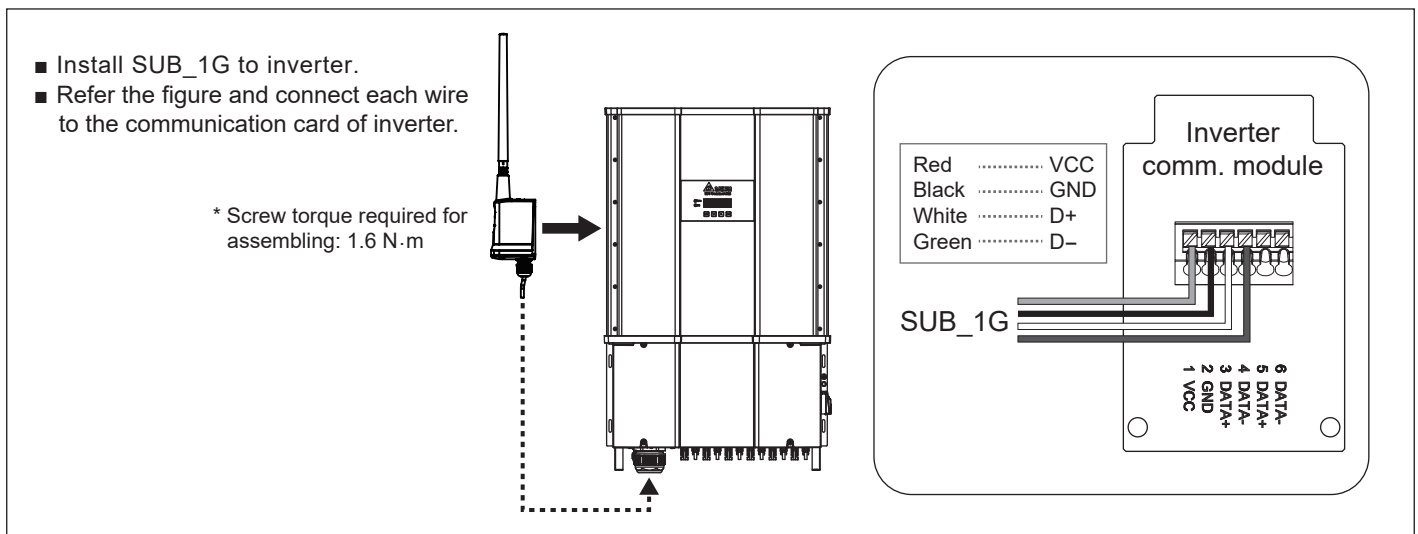

3. Supported inverter models

3.1. Normal mode

Inverter connect with DC1 via Wired (RS-485) or Wi-Fi, DC1 transfer inverter data to Delta Cloud or 3rd party monitoring device.

- Connection type DC1 - inverter

Connection type	Solivia G3	Solivia G4	RPI HxA	HXA_2XX	M6A	M8A	M10A	M15A	M20A	M30A	M50A	M70A	M88H	M125HV	...
Wired (RS485)	y	y	y	-	y	y	y	y	y	y	y	y	y	y	
Wi-Fi	-	-	-	y	-	-	-	-	-	-	-	-	-	-	
Mixed	y	y	y	y	y	y	y	y	y	y	y	y	y	y	
SUB_1G	-	-	-	-	-	-	-	-	-	-	-	y	y	y	

Wired: max 32 inverters

Wi-Fi: max 9 inverters

Mixed: max 32 inverters

SUB_1G: max 25 inverters

- Connection type DC1 - Router

Ethernet or Wi-Fi

- Connection type DC1 - Smartphone

Wi-Fi

- Hints and Tipps

3.2. Retrofit mode

Converts data into SOLIVIA protocol.

Connection type	Solivia G3	Solivia G4	RPI HxA	HXA_2XX	M6A	M8A	M10A	M15A	M20A	M30A	M50A	M70A	M88H	M125HV	...
Wired (RS485)	not available														
Wi-Fi	-	-	-	y	-	-	-	-	-	-	-	-	-	-	
Mixed	not available														

Hints and Tipps

One of the connected inverters must have RS485 ID (Inverter ID) = 1

4. Commissioning

4.1. First startup

To use Delta cloud service, user will have to register Data Collector to cloud, please refer following procedure.



MyDeltaSolar

1. This APP should collocate with Delta Inverter.
2. If inverter is not connected to cloud, you still can monitor inverter operation by APP.

Where can search for MyDeltaSolar APP?

- QR Code: Please scan the QR code to MyDeltaSolar cloud.
- IOS system: Please search "MyDeltaSolar" in App store.
- Android system: Please search "MyDeltaSolar" in Google Play.



QR Code



IOS

<https://itunes.apple.com/ng/app/mydeltasolar/id1271609228?mt=8>



Android

https://play.google.com/store/apps/details?id=com.mydeltasolar_1_0_0.app&hl=zh-TW

ATTENTION



- Please check the smart phone is connected to the Internet and the communication is good.

[1]

After opening the MyDeltaSolar APP, please click [Create account] to apply for an account. (Suggestion)

If you do not apply for an account, please click the icon on the top right  to access the APP through the P2P connection.

[2]

After checking the box, click the [OK] button.

[3]

Please fill-in basic information when register an account.

▶ Delta has the option of providing cloud services, allowing users to have multiple locations anytime, anywhere. The monitoring and management of the case, all the information will be collected and stored in the cloud reliably. Further analysis of the anomaly and automatic notification to the user for repair as soon as possible and replacement to avoid causing greater power loss. If cloud services is not required by user, please select “No”. In this case, user may need to setup third party monitoring system. Please find instruction in chapter 5.4.

▶ APP is designed to connect and monitor different target devices, if there is a Data Collector on the plant, you can directly connect to the Data Collector. Monitor and display multiple Inverters through it.

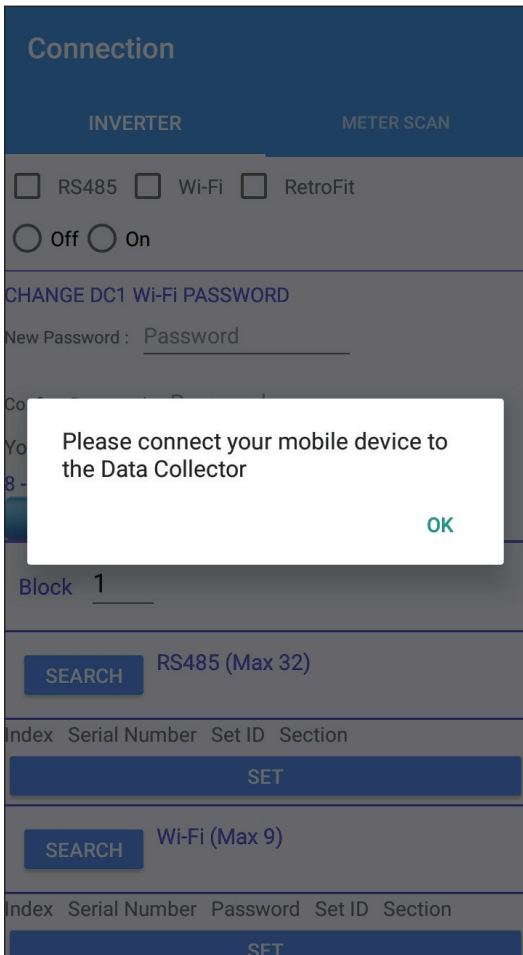

[4]

Please go to the Wi-Fi settings page and connect your mobile device to Data Collector.

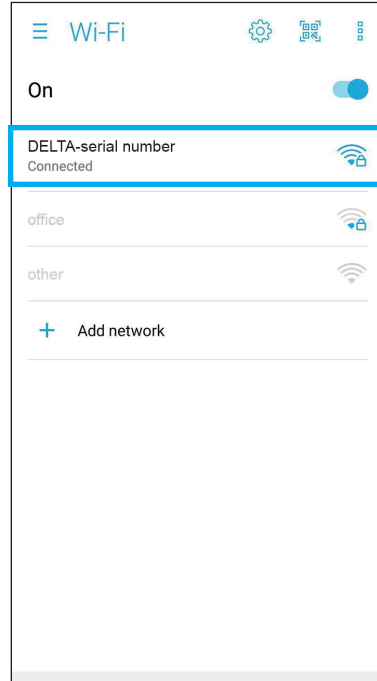

[5]

SSID will be "DELTA-serial number".
 (The serial number information is indicated on the rating label of the machine)
 The password is "DELTASOL"

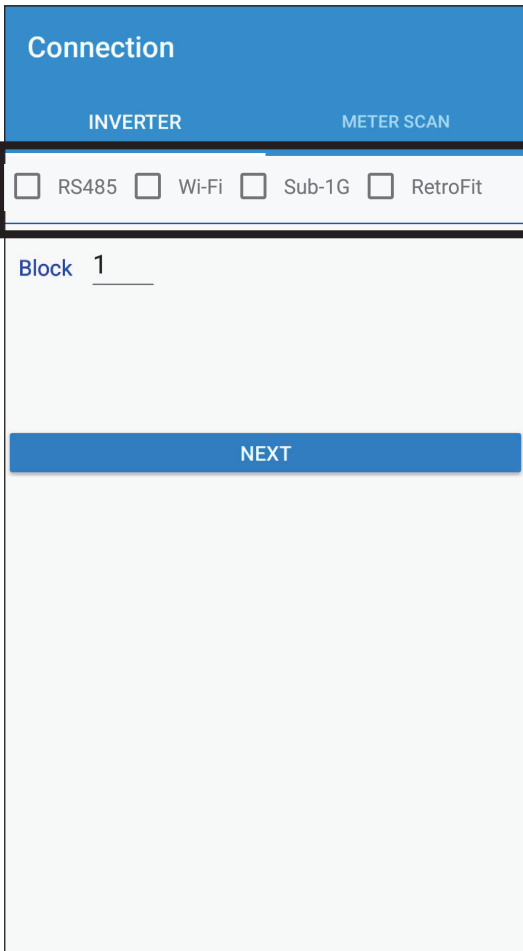
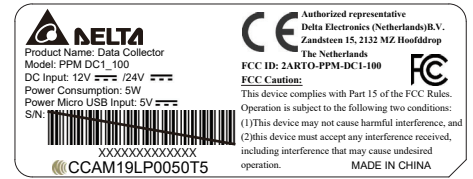

[6]

After connecting to the Data Collector, please go back to the APP for connection. Please select your connection mode. [RS-485/ Wi-Fi/ RetroFit/ Sub_1G]
 (Please refer to Chapter 5 for more detailed setting process of each mode)

[RS-485]

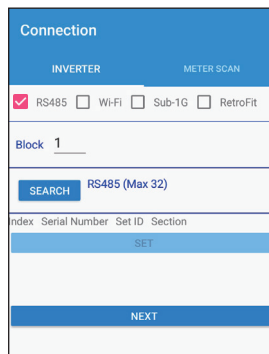

[Wi-Fi]



[Sub_1G]

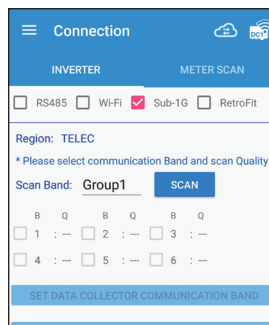

[RetroFit]

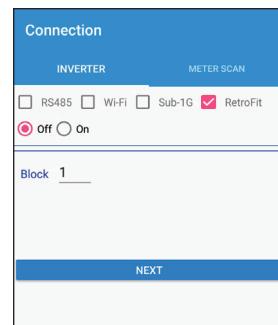

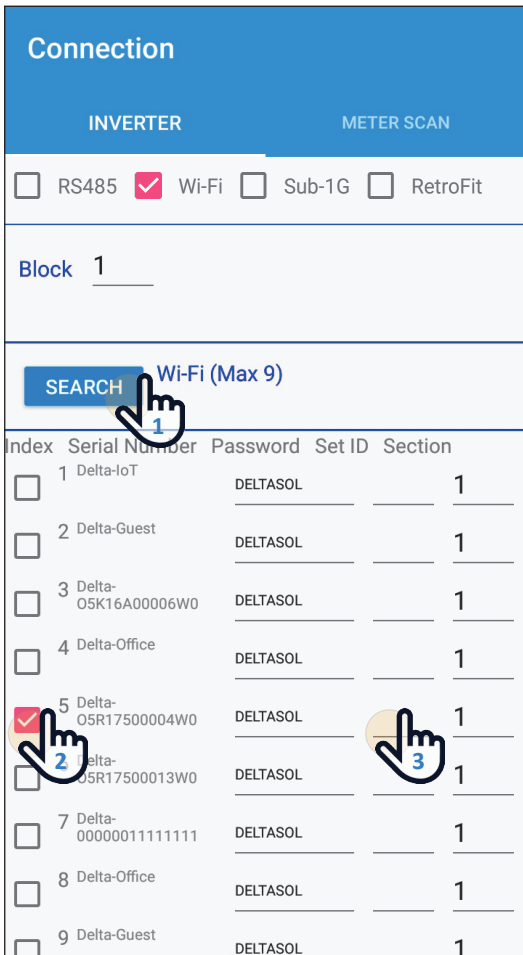

[7] (Take Wi-Fi connection as example.)

1. Please click [SEARCH] to detect inverter
2. Please check your inverter serial number (the serial number information is marked on the rating label of the machine)
3. Set the inverter ID
4. After confirming, please click the [SET] button. (please wait 2 to 10 minutes for setting, depending on how many inverter connect to Data collector)



Wi-Fi communication will be disconnected from your Data Collector account at this time.
Please go back to the Wi-Fi settings page and reconnect to the Data Collector.

5. When the message [Connected Successfully] appears, click the [NEXT] button to proceed to the next step.

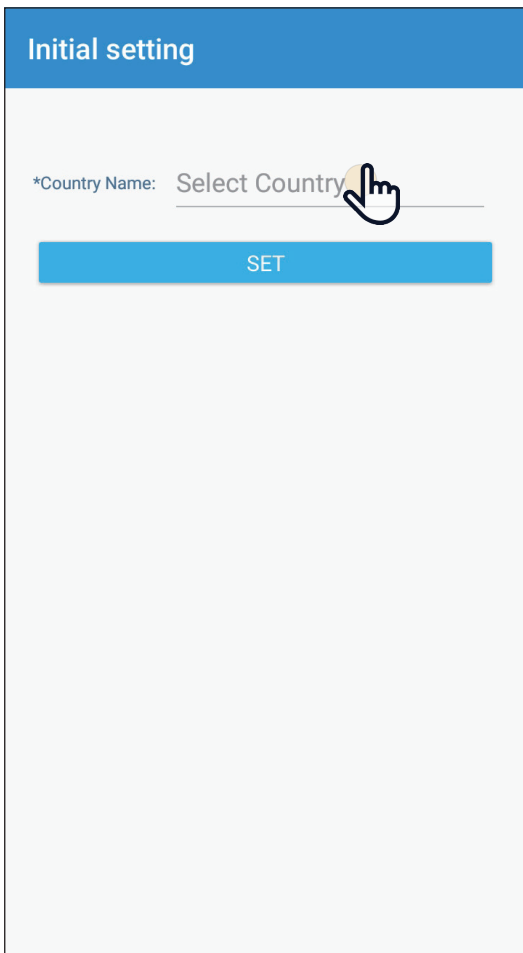
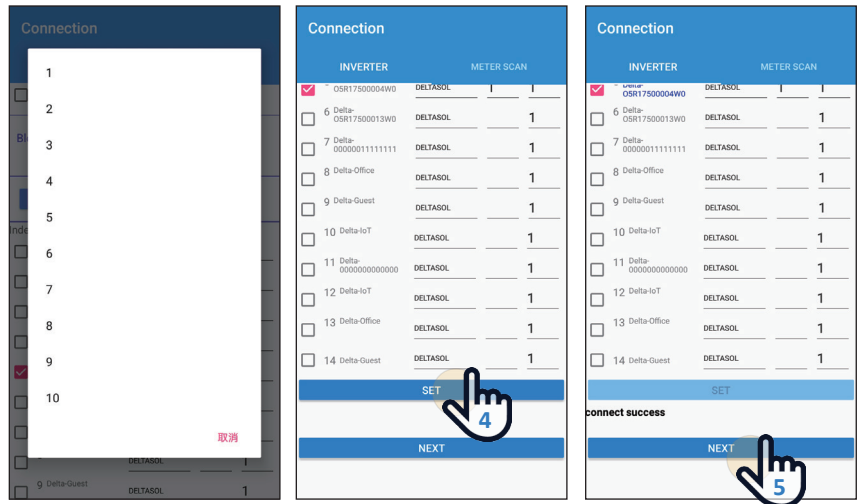

[8]

Please select proper country code for data collector to set inverter.

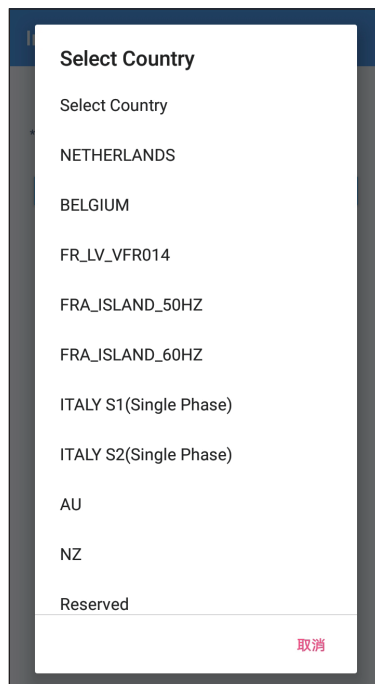

CLOUD REGISTER

User Account

Email:

Password:

Plant Register

Plant Name:

Country:

Time Zone:

SET INFO

[9]

Please confirm cloud register information and select correct time zone of your region. (Cloud service will display the information base on country and time zone, such as weather, map indicate...etc)

CLOUD REGISTER

User Account

Email:

Password:

Plant Name:

Country:

Time Zone:

SET INFO

Set complete

OK

[10-1] ETHERNET

CLOUD REGISTER

User Account

Email:

Password:

Which interface will this Data Collector connect to Cloud?

ETHERNET **1** WI-FI ROUTER

Country:

Time Zone:

SET INFO

Network

Network Setting

Interface:

Protocol: **static** **2**

IP Address:

Subnet Mask:

Gateway IP:

DNS 1:

1. Click "ETHERNET"

2. Protocol:

- If select "static", please fill in IP address for this DC1, Subnet mask of the network, Gateway IP and DNS, then click "SET INFO".
- If select "DHCP", APP will connected to cloud automatically.

3. Click "OK" to proceed.

4. When Cloud register success shows up, means DC1 has already connect to cloud.

5. User can start monitoring data from Delta cloud.

Network

Email:

Password:

Please connect to internet

OK **3**

Country:

Time Zone:

SET INFO

Network

Email:

Cloud Register

Cloud register success! Press ok to go to cloud page.

OK **4**

Country:

Time Zone:

SET INFO



[10-2] WI-FI ROUTER

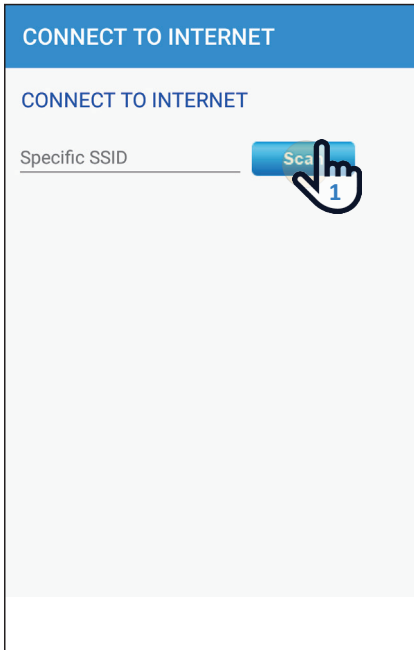

1. Click "Scan" to find WiFi signal you want to connect.

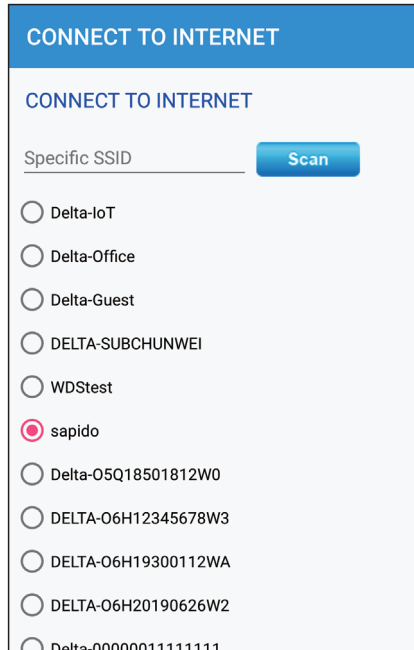

2. Select the proper WiFi SSID

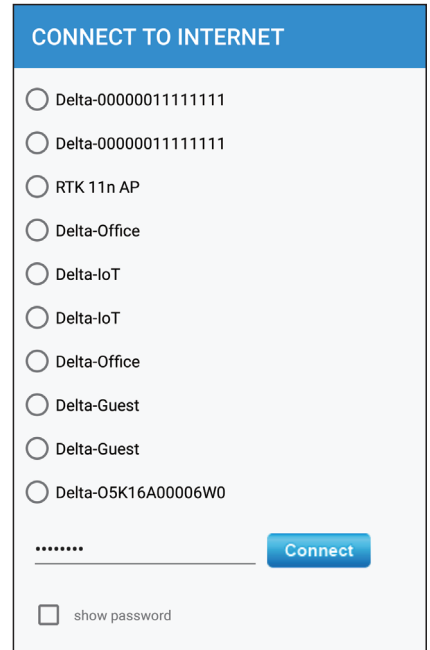

3. Type in WiFi password and click "Connect" to connect to the WiFi.

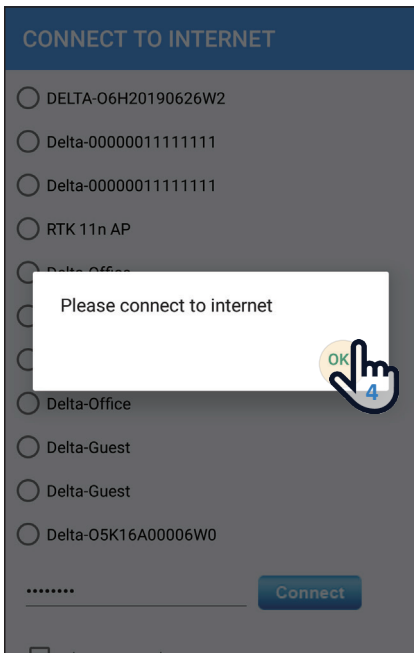

4. click "OK" to next step, make sure you mobile have the internet ability.

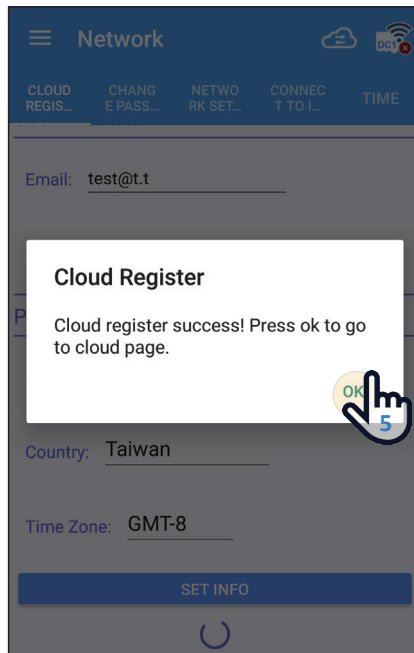

5. Wait around 15~30 second, DC1 will connect to cloud, click OK to go to cloud home page.

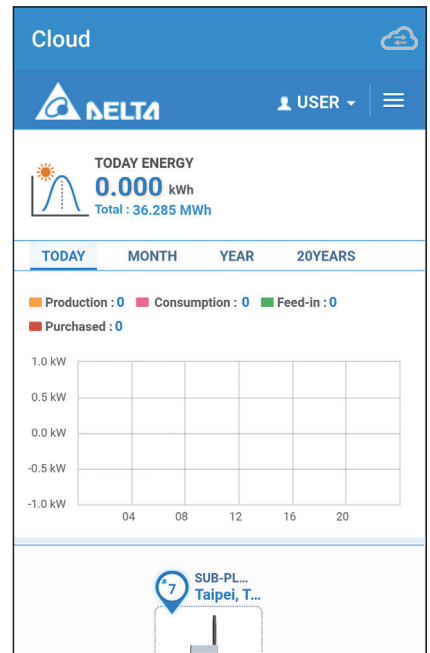

6. User can start monitoring data from Delta cloud.

4.2.Home Page (APP)



There are some slight differences between ios and Android's APP screen layout.
This manual uses the Android system APP screen representative to explain.

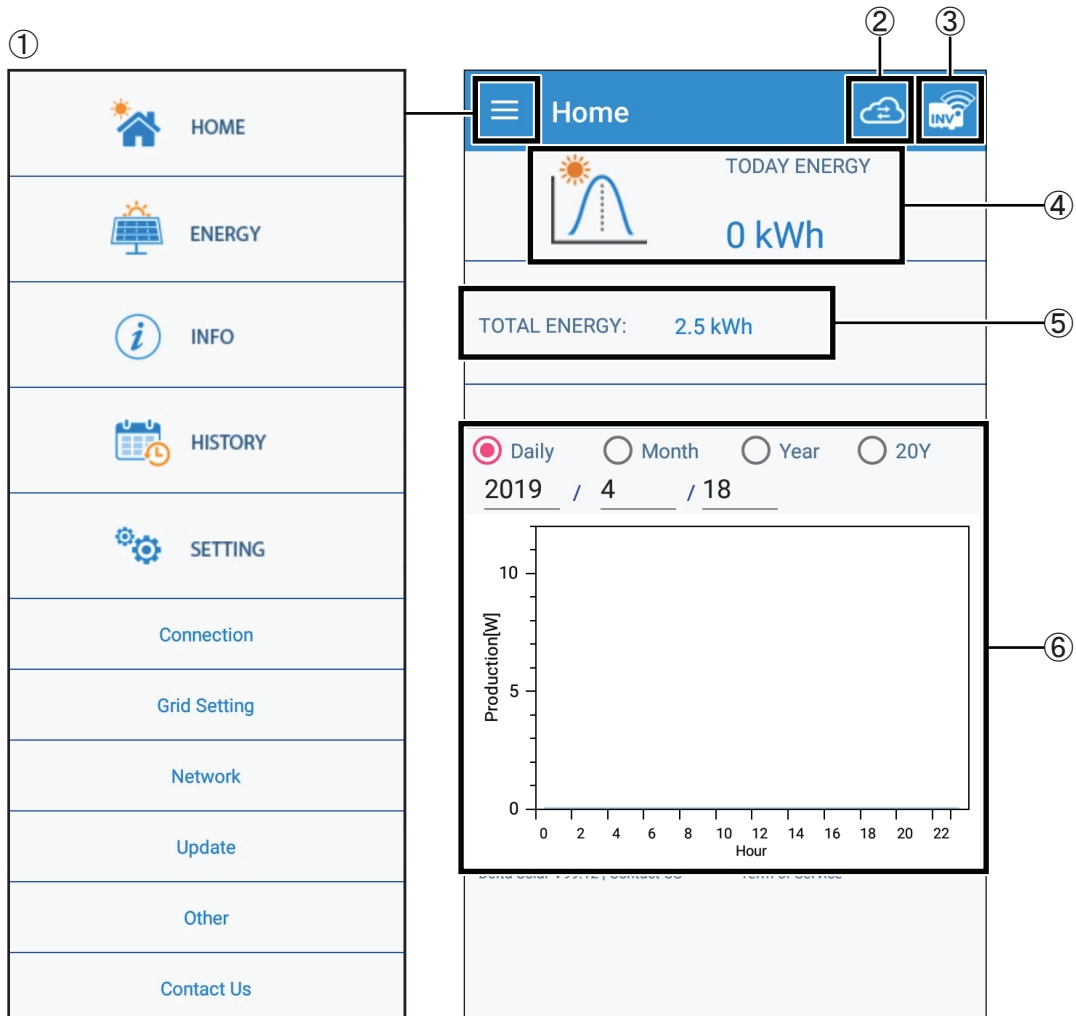

① Main menu

For details, please see the section "Description of the screen display".

② Switch to the cloud page

For a detailed introduction, please see the "Description of the page display (Cloud)" section.

③ Confirm Inverter connection status

If the Inverter is disconnected, the disconnection icon will be displayed.

④ Today Energy

Display Today Energy.

⑤ Total Energy

Display Total Energy.

⑥ Energy Maps

Display different Energy maps according to the selected time interval.

4.3.Operation Screens

The APP in the following manner operations and connection setting. Details and operations of respective page are described in the “Description of the screen display” section.



- The pages surrounded by a frame of dotted line are not displayed When no login account.
- Pages indicated with solid lines are displayed for ordinary operations.
- The pages in gray are displayed when enter password. (for industrial authority)

■ List of Operation APP Pages

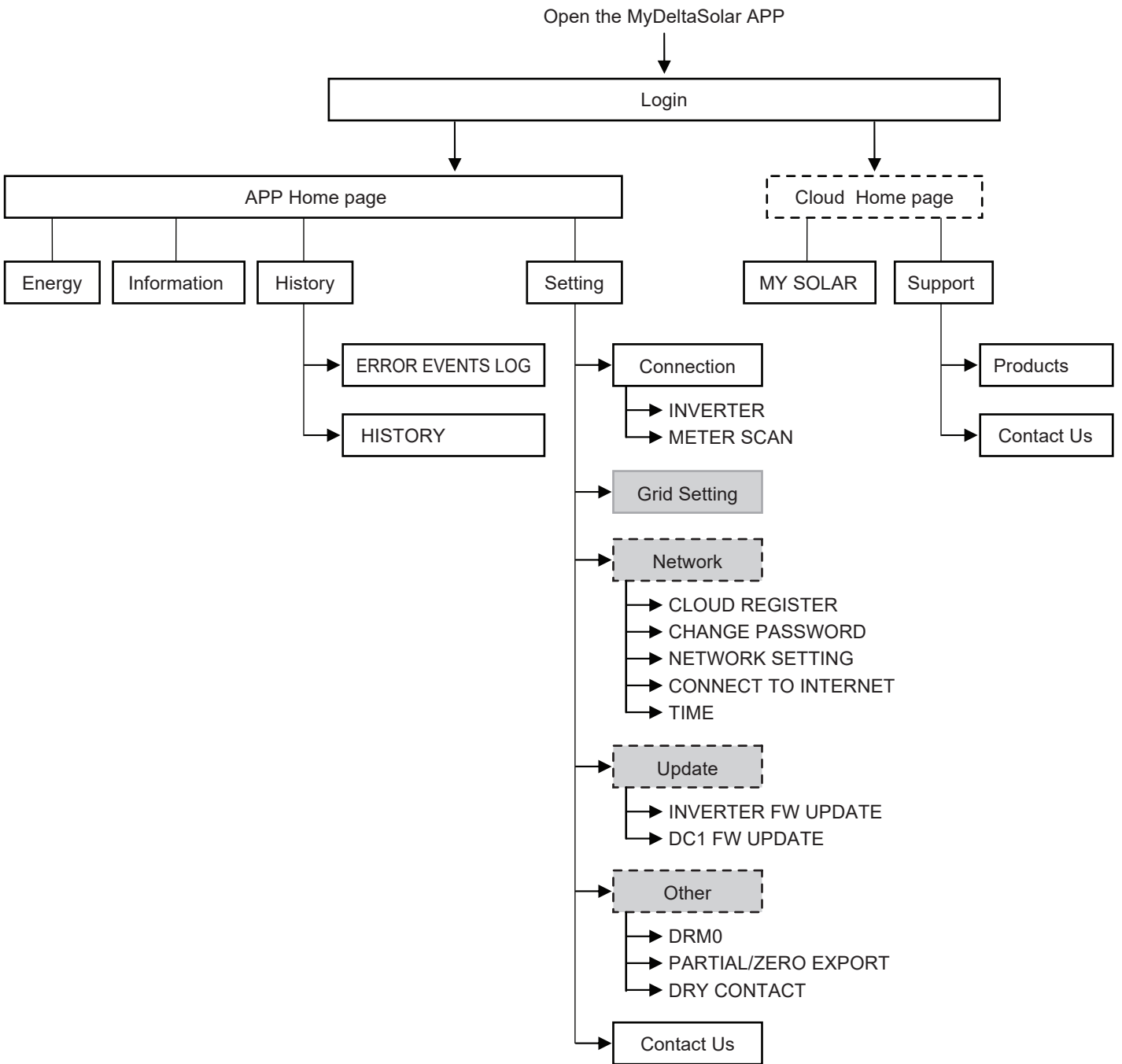

4.4.Reset Method

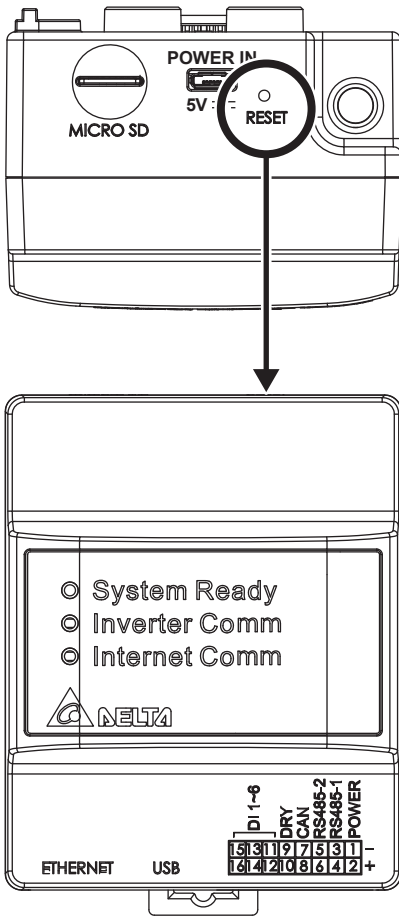

Press reset button	System ready led flashing	Action of DC1
3~5 sec	0.5sec ON, 0.5sec OFF	Rebuild wifi module
6~10 sec	1sec ON, 1sec OFF	Reset wifi password and rebuild wifi module
Over 15sec	2sec ON, 2sec OFF	Reset DC1 setting without SN, then reboot

5. DC1 mode setting process

This chapter contains the system architecture diagram and setting process of RS-485, WI-FI, SUB-1G, RetorFit and 3rd party.

5.1. Normal mode (RS-485)

The RS-485 Inverter is set by operating the DC1 through the APP. Upload power generation data to Cloud Server for monitoring.

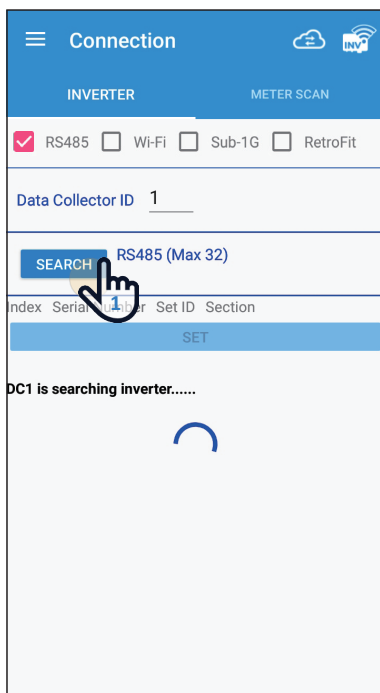
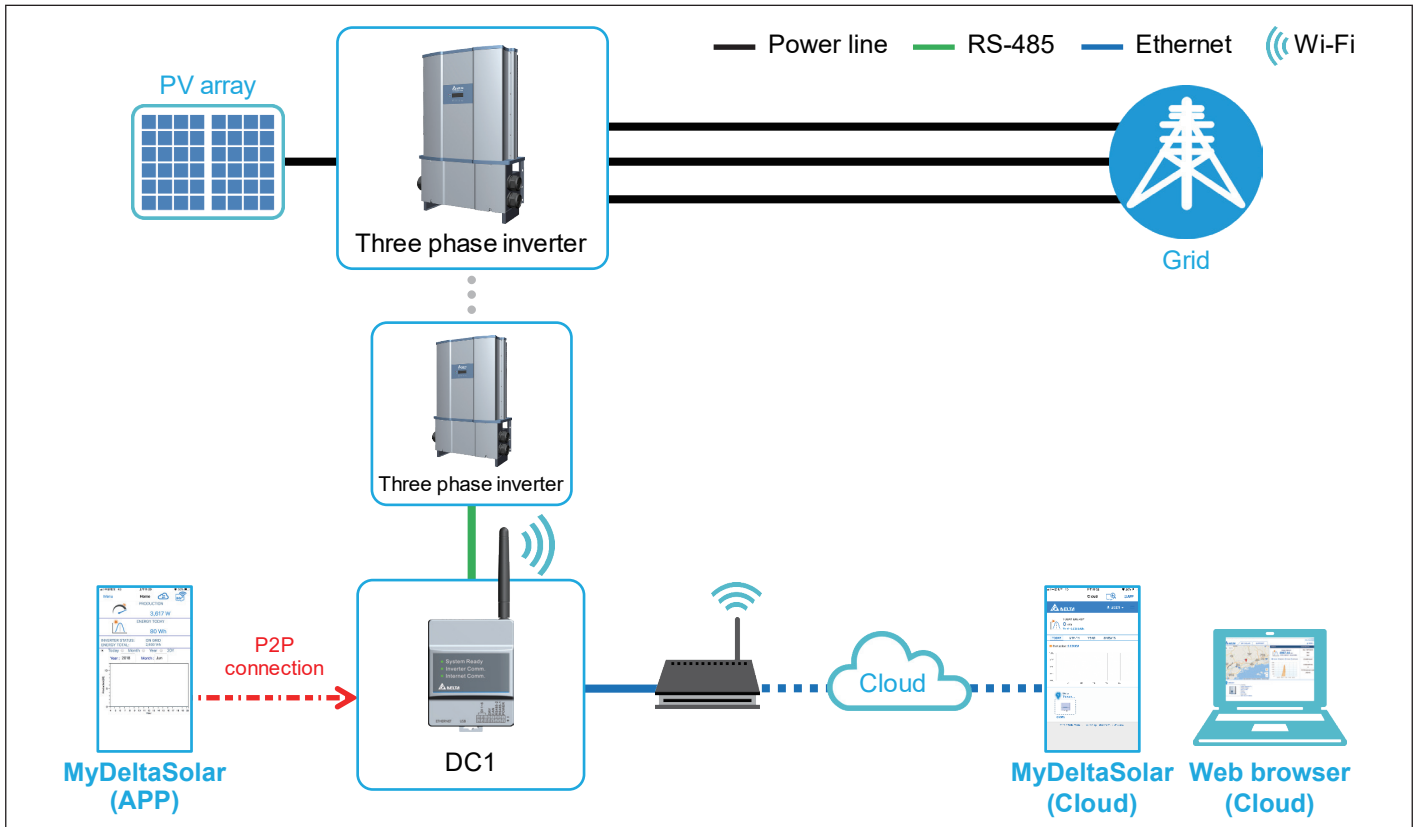

2. Please check your inverter serial number. (the serial number information is marked on the rating label of the machine)
3. Set the inverter ID.
4. After confirming, please click the [SET] button. (wait for 2 minutes to set)
5. When the message [Connected Successfully] appears, the setting is completed.

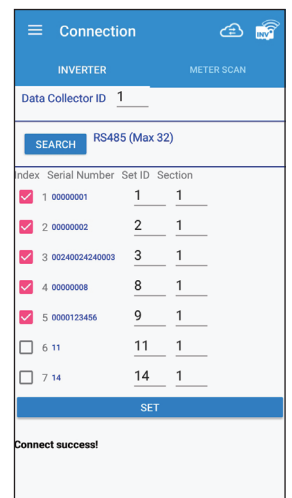
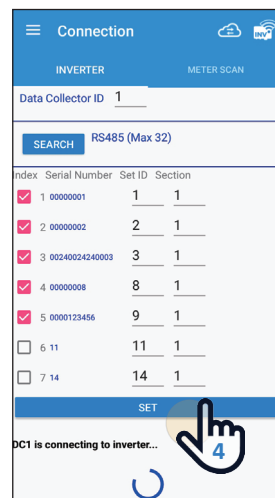
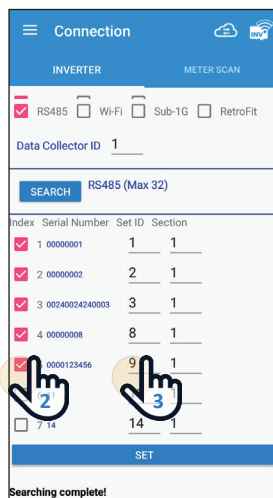

After the RS-485 mode setting is completed, go back to **chapter 4.1 step [8]**.

5.2.Normal mode (Wi-Fi)

The WI-FI Inverter is set by operating the DC1 through the APP. Upload power generation data to Cloud Server for monitoring.

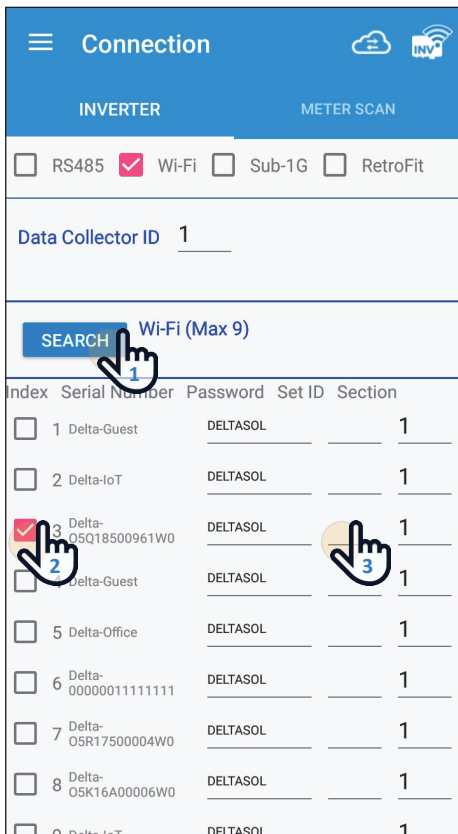
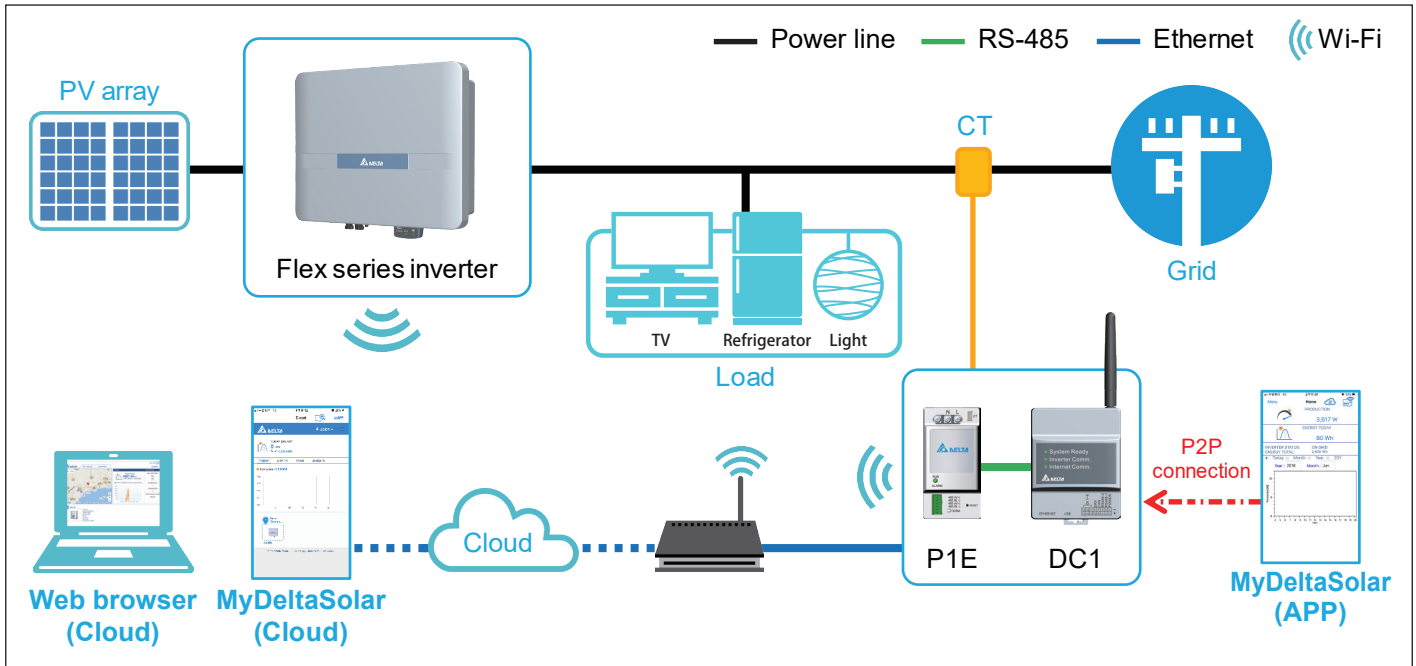

1. Please click [SEARCH] to detect inverter
2. Please check your inverter serial number (the serial number information is marked on the rating label of the machine)
3. Set the inverter ID
4. After confirming, please click the [SET] button (wait for 2 to 10 minutes to set, depending on the number of inverter settings)



Wi-Fi communication will be disconnected from your Data Collector account at this time. Please go back to the Wi-Fi settings page and reconnect to the Data Collector.

5. When the message [Connected Successfully] appears, the setting is completed.

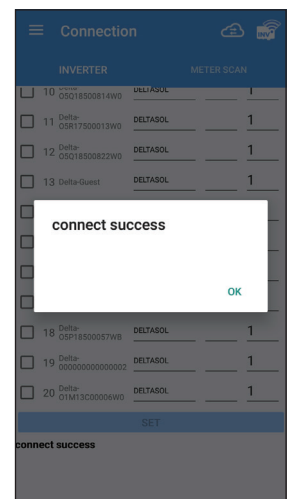
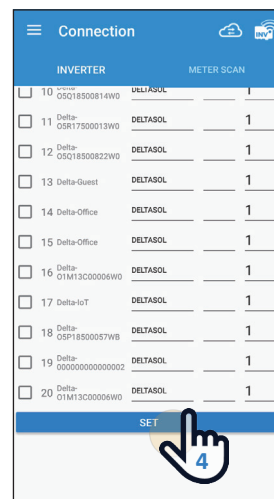
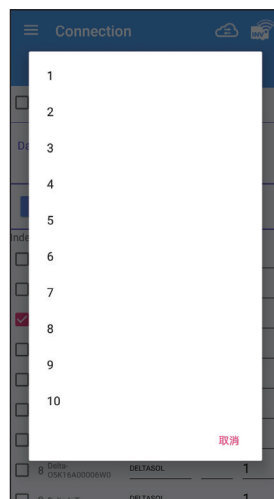

After the Wi-Fi mode setting is completed, go back to **chapter 4.1 step [8]**.

5.3.Normal mode (SUB_1G)

• What is SUB_1G?

SUB_1G is a wireless communication with a frequency lower than 1GHz. Compared with 2.4GHz Wi-Fi, SUB_1G has a longer transmission distance, stronger penetrate and can cover a larger range, so it is suitable for a wide range field. Compared to the traditional RS485, SUB_1G do not have to do RS485 wiring work and can save the cost.

• How to set up SUB_1G efficiently?

To make the Data Collector and Inverters communicate better with largest coverage, please install the Data Collector in the middle of the block.

To monitor the field, each block will have one Data Collector (DC1) to transmit wireless signal through Sub-1G device (N1) and Inverter (N2 or N3). With the app, users can connect Inverter and Data Collector, and then upload the collected data to the Delta Cloud by Ethernet or Wi-Fi, or upload to the 3rd party monitoring by LAN for management.

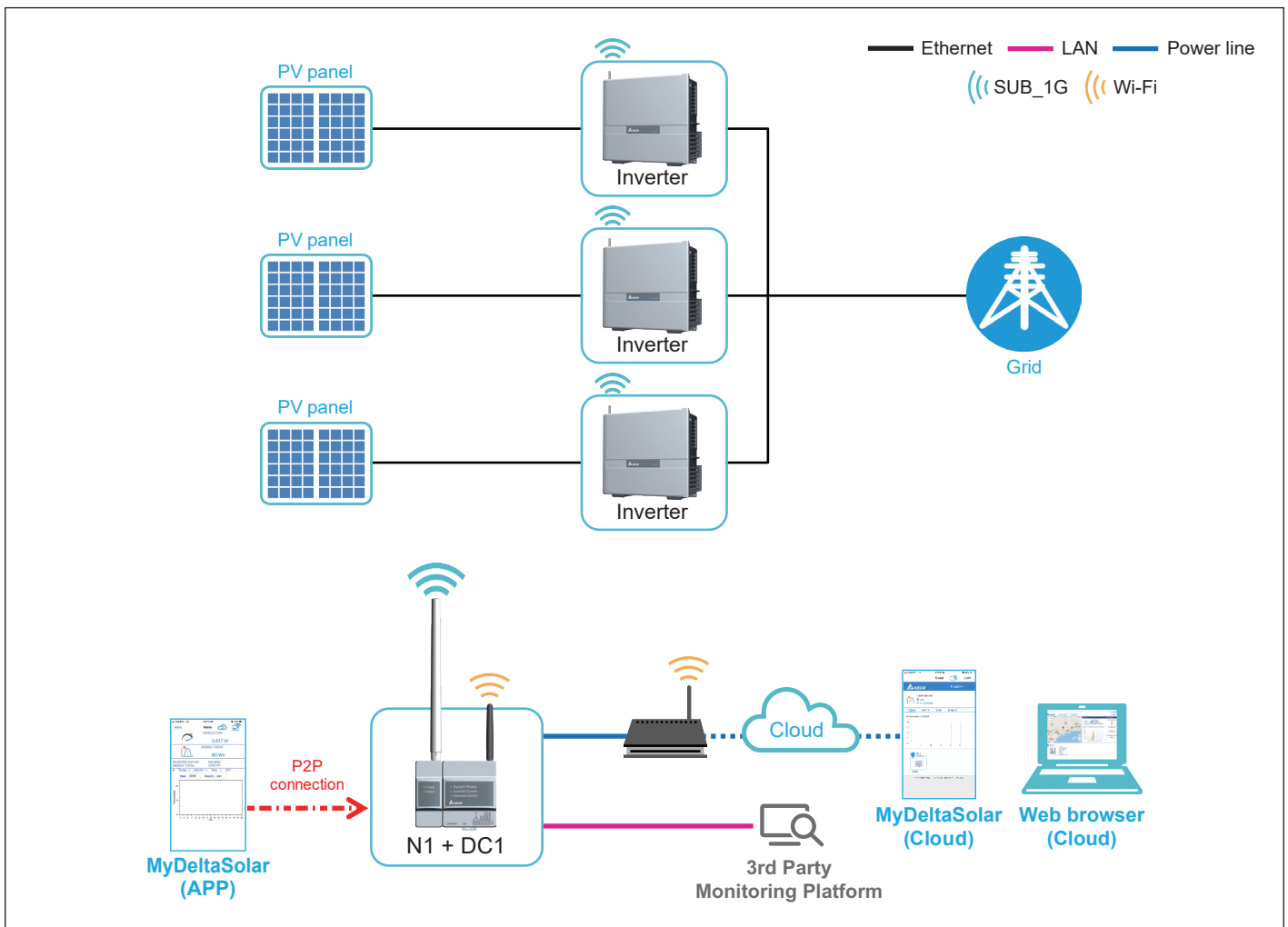
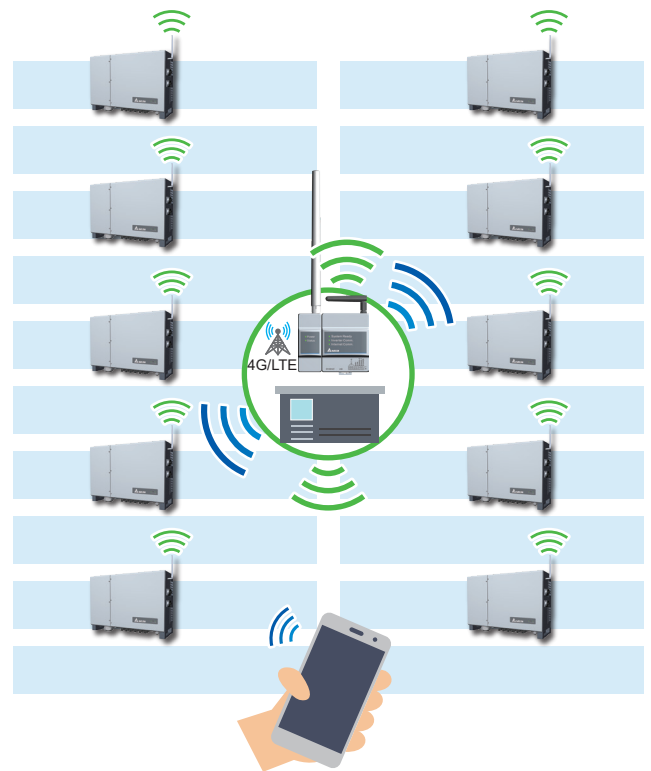

· SUB_1G Connection page

1. Band Selection

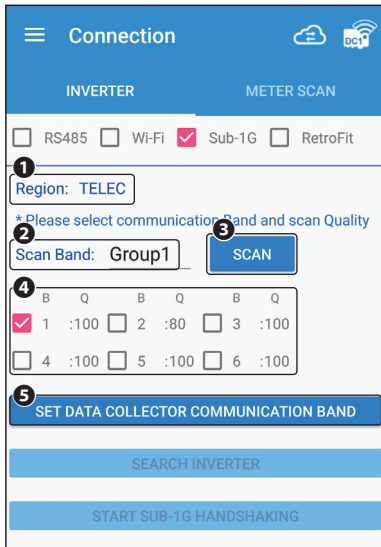

- ① **Region**
The device area currently set. For example, TELEC indicates the Japanese region.
- ② **Scan Band**
Each Band represents a different frequency combination. It will put 6 bands into one group to search efficiently, if the group can not find the appropriate frequency band, try to scan other groups. For example, there are 120 Bands in TELEC, "Group 1" displays "Band 1 to Band 6", "Group 2" displays "Band 7 to Band 12", and so on.
- ③ **SCAN**
After selecting group, click SCAN. It will show communication quality scores of the six bands in the group.
- ④ **Scan Quality**
The top score is 100 points, the higher the score, the better the communication quality. During the scanning process, if it finds other signal interference, the score will be deducted. When the score is lower than 80, users will not be able to select the Band.
- ⑤ **SET DATA COLLECTOR COMMUNICATION BAND**
After selecting band, click SET DATA COLLECTOR BAND to set up.

2. Search Inverter

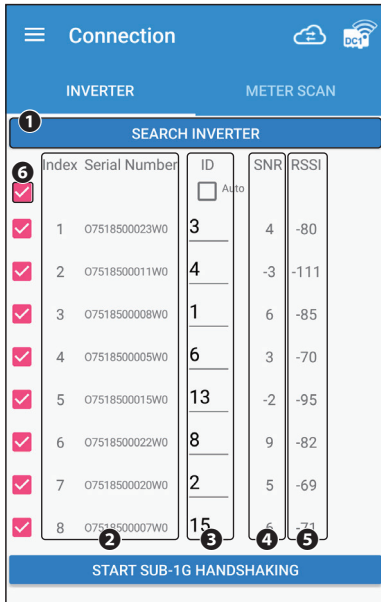

- ① **SEARCH INVERTER**
Press this button, Data Collector will list the nearby Inverter that has not been set.
- ② **Index & Serial Number**
The serial number of the Inverters.
- ③ **ID**
Showing the original ID of Inverter. Users can change the number by drop-down menu.
- ④ **SNR**
One of the parameters to check communication quality, usually a positive value. Indicating how much times the signal is stronger than the noise. The larger the value, the stronger the signal, the better the connection quality. When the SNR is less than 0, it is not recommended to choose.
- ⑤ **RSSI**
One of the parameters to check communication quality, usually a negative value. Indicating the value of RF signal. The larger the value, the stronger the signal, the better the connection quality. For example, the signal of -60 is better than -80. When the RSSI is less than -105, it is not recommended to choose.
- ⑥ **Select All**
Select the top checkbox will also select all checkboxes.

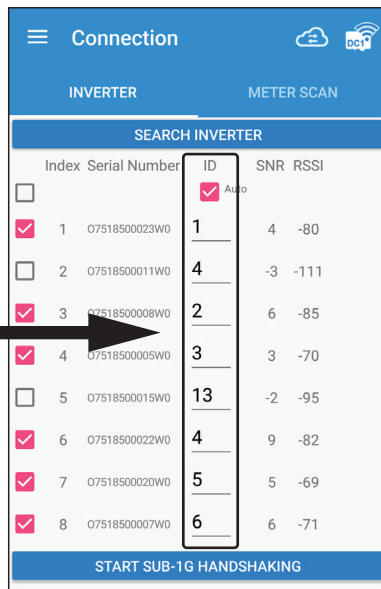
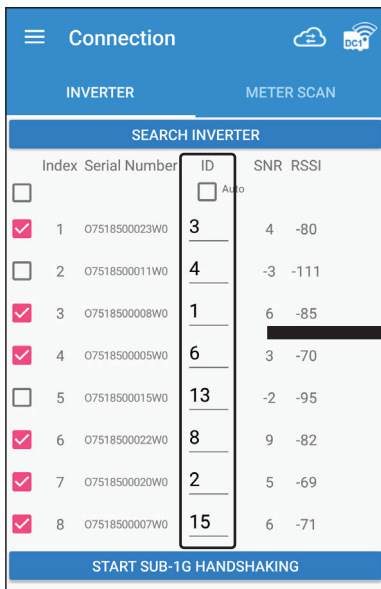

The ID of the inverters you selected will rearrange after selecting "Auto". For example, the original ID sequence 3, 4, 1, 6, 13, 8, 2, 15 changed to 1, 4, 2, 3, 13, 4, 5, 6. De-select "Auto" will change back to the original ID.

3. SUB-1G HANDSHAKING

Click "START SUB-1G HANDSHAKING" will do the following steps, please wait for a moment.

- Set Inverter ID
- Collect Inverter Information
- Sync time with Inverter
- Set Communication Band
- Set monitor on

When Handshaking complete, means all settings are done and starts to monitor inverters.

· Start Installing Process

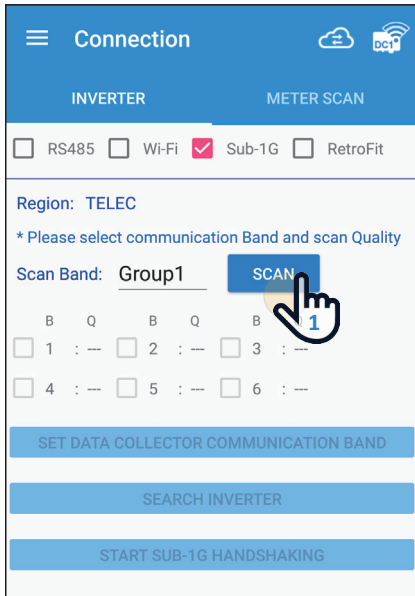

1. Select Sub-1G and click “SCAN” to scan the quality of frequency band in the group.

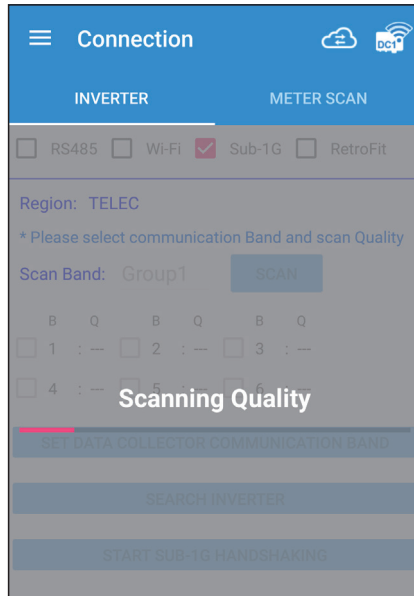

2. Wait around 60sec for DC1 to scan the band quality.

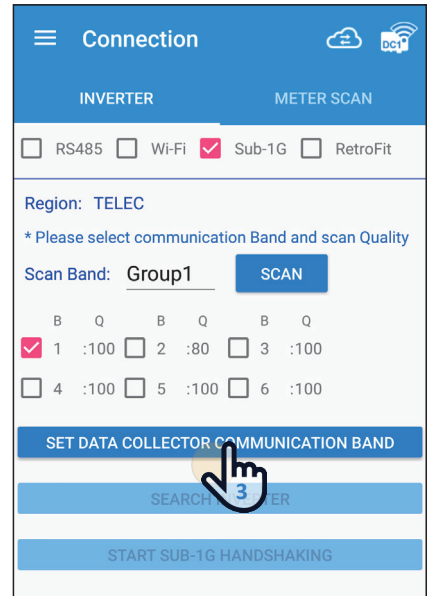

3. Select the band with high quality, click “SET DATA COLLECTOR COMMUNICATION BAND”.
*If the quality is lower than 80, we suggest change to another group and scan again.

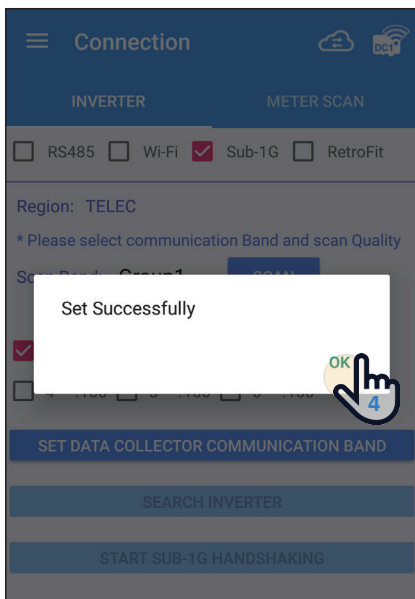

4. Click “OK” to next step, DC1 has been set to the frequency band in this step.

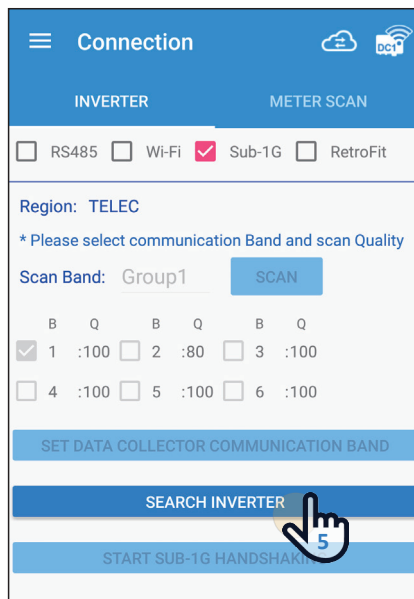

5. Click “SEARCH INVERTER” to search the inverter you want to connect to DC1.

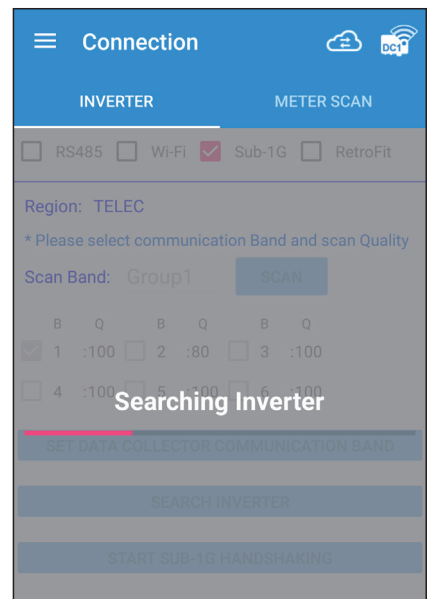

6. Please wait around 30sec to search inverter.

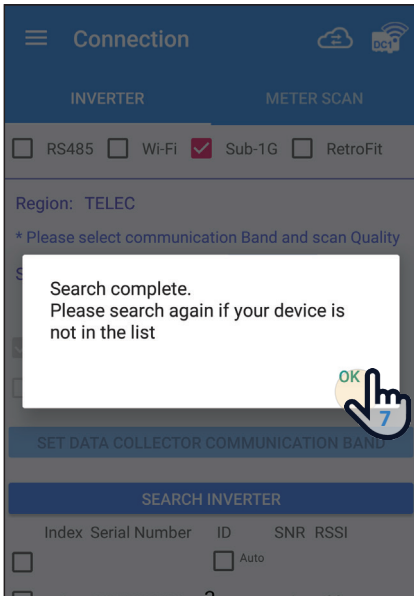

7. Click “OK” to next step.
*If the inverter is not on the list please try step13 again.

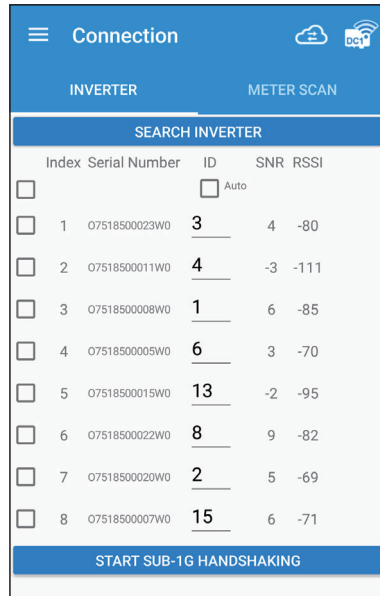

8. Check if your inverter is on the list.

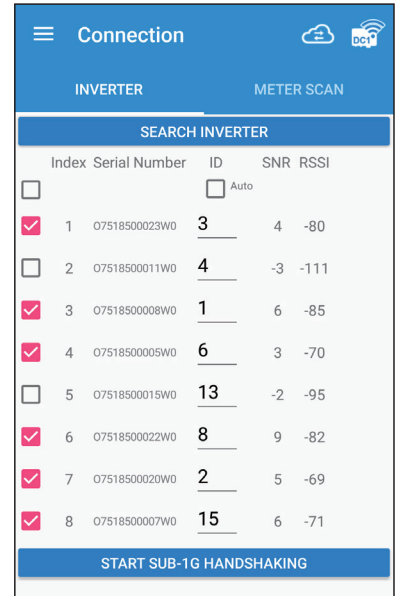

9. Select the inverter you would like to connect to DC1.

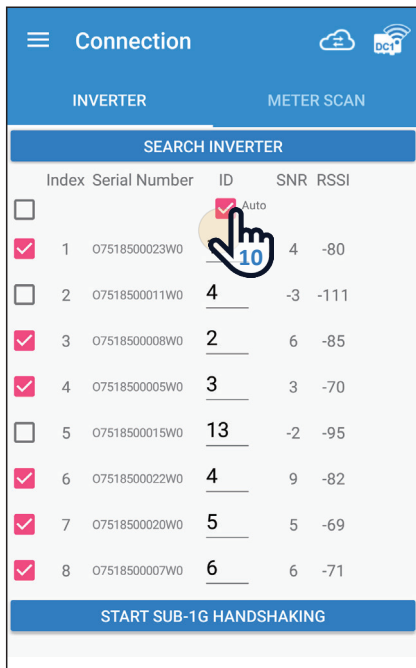

10. Click “Auto” APP will set the ID automatically, users can also set the ID manually.

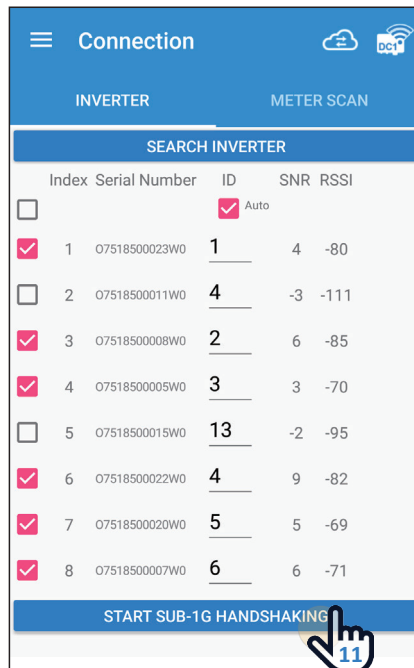

11. Click “START SUB-1G HANDSHAKING” to set inverter.

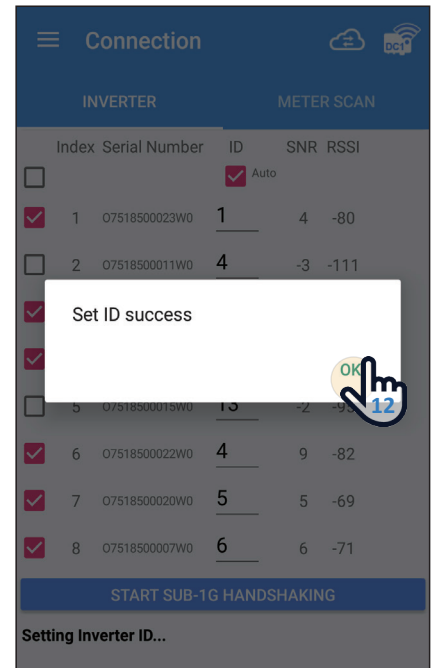

12. Click OK to next step, inverters ID have been set in this step.

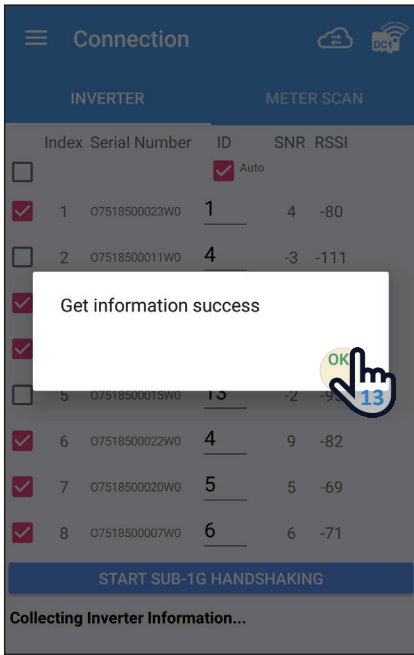

13. Click OK to next step, DC1 has got inverters information in this step.

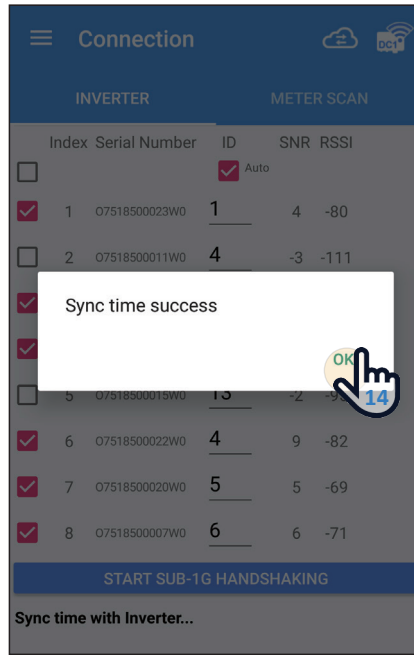

14. Click OK to next step, DC1 has sync the time with inverters.

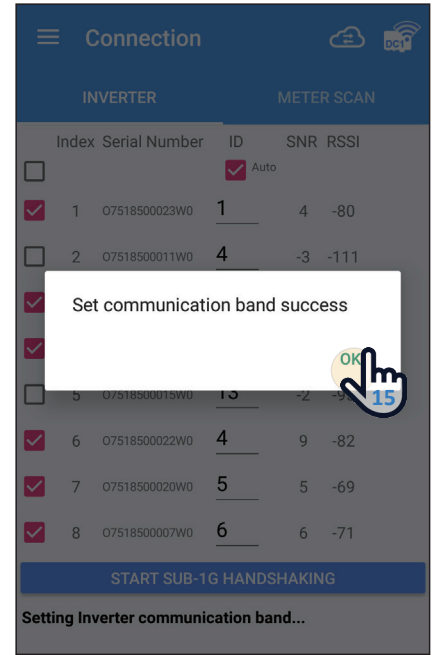

15. Click OK to next step, inverter's Sub-1G frequency band have been set in this step.

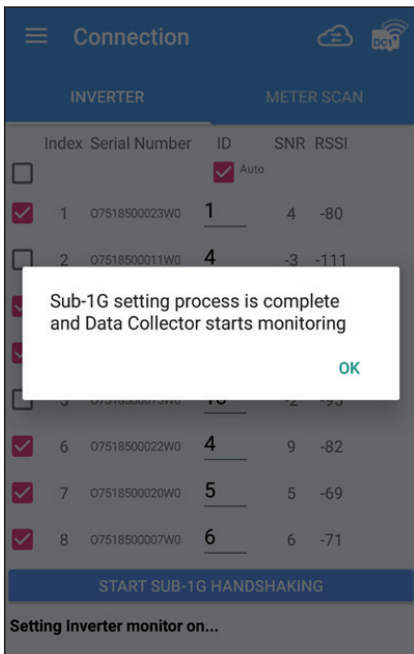

16. Click OK to next step, all inverter has connected to DC1 in this step.

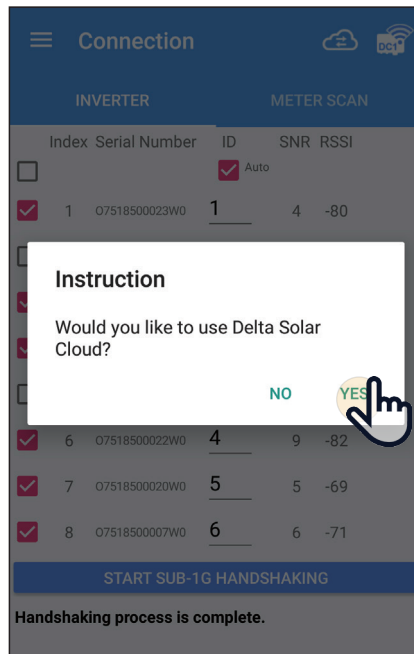

17-1. Click "YES" and then go back to **chapter 4.1 step [8]**.

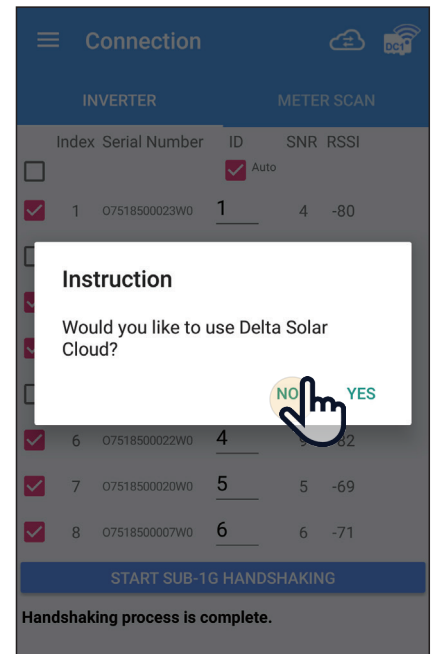

17-2. Click "NO" will leads to "Install Settings", select your country and then go to **chapter 5.5 (3rd party monitoring)**.

5.4.Retrofit mode

This function is Solivia Gateway Only, and the WI-FI Inverter is set by the APP operation DC1.
Start Solivia Gateway to start monitoring and then monitor on Solivia Cloud.

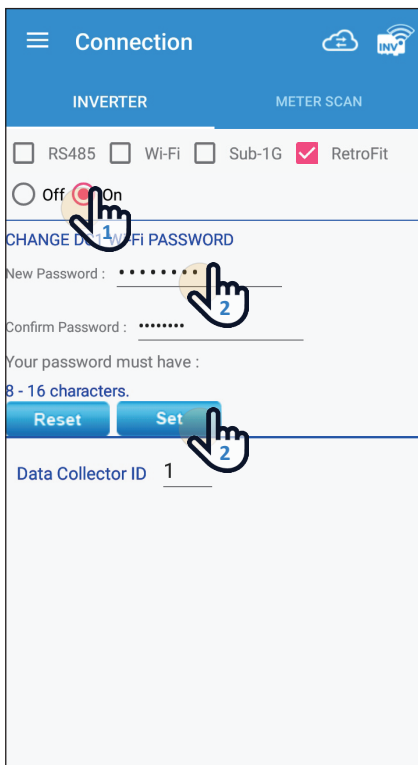
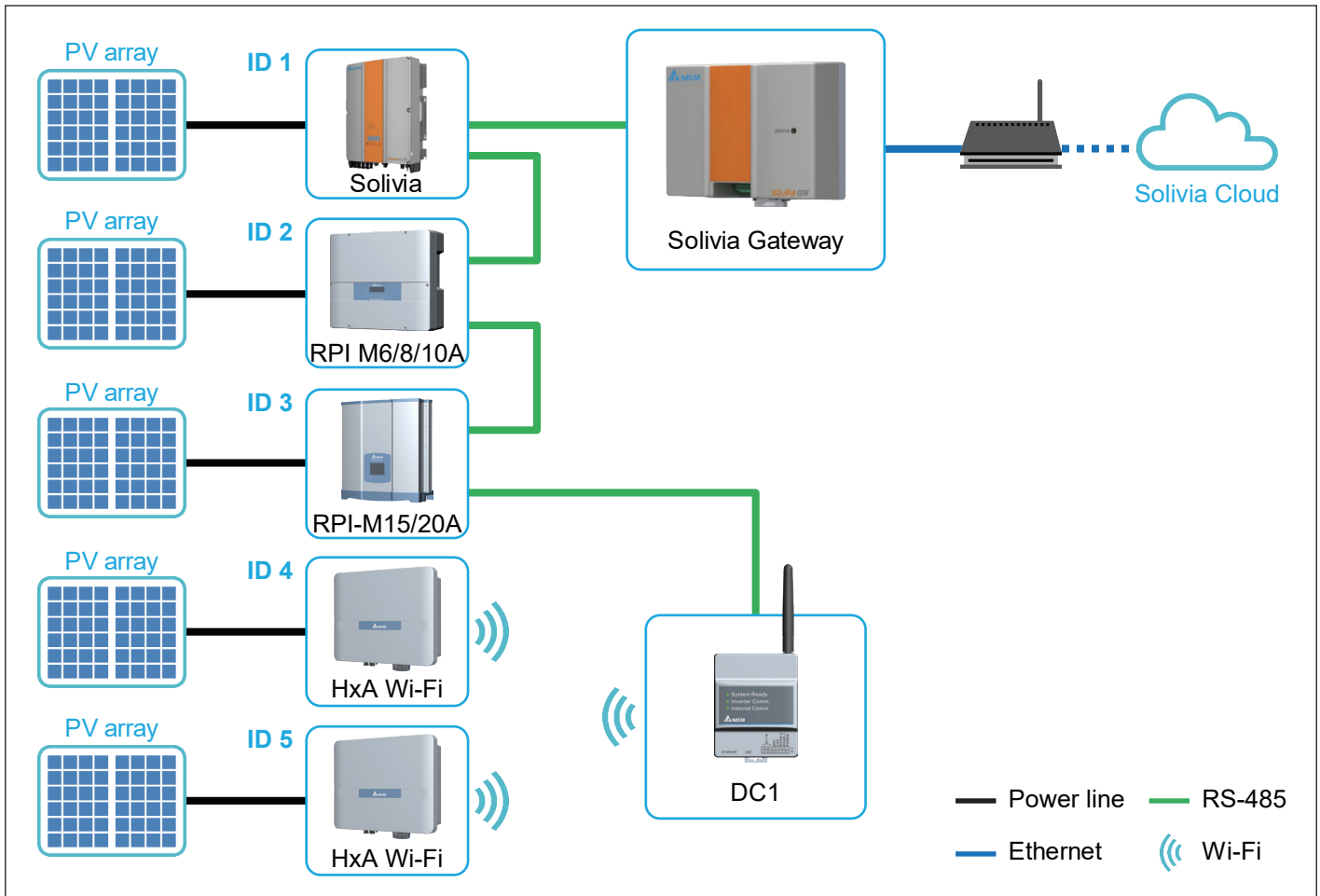

1. Please click [On] to detect the Open Retrofit mode.
2. Modify the WI-FI password of DC1 and click the [SET] setting.



Wi-Fi communication will be disconnected from your Data Collector account at this time.
Please go back to the Wi-Fi settings page and reconnect to the Data Collector.

3. Switch to the WI-FI setting page of the mobile phone and modify the WI-FI password to connect and switch back to the APP page.

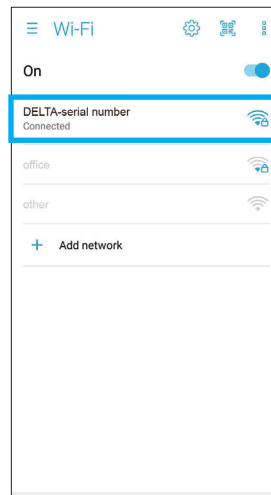
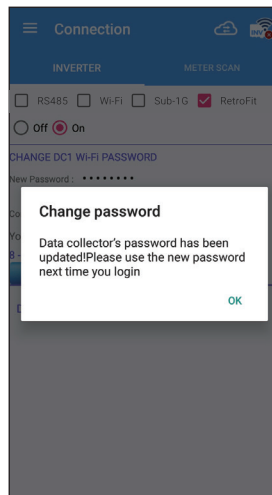

4. Check [RetroFit] again and click [On]. Click [Search] to detect Inverter.
5. Please check your inverter serial number. (the serial number information is marked on the rating label of the machine)
6. Set the inverter ID.
7. After confirming, please click the [SET] button. (wait for 2 to 10 minutes to set, depending on the number of settings)

 Wi-Fi communication will be disconnected from your Data Collector account at this time. Please go back to the Wi-Fi settings page and reconnect to the Data Collector.

8. When the message [Connected Successfully] appears, click the [NEXT] button to proceed to the next step.

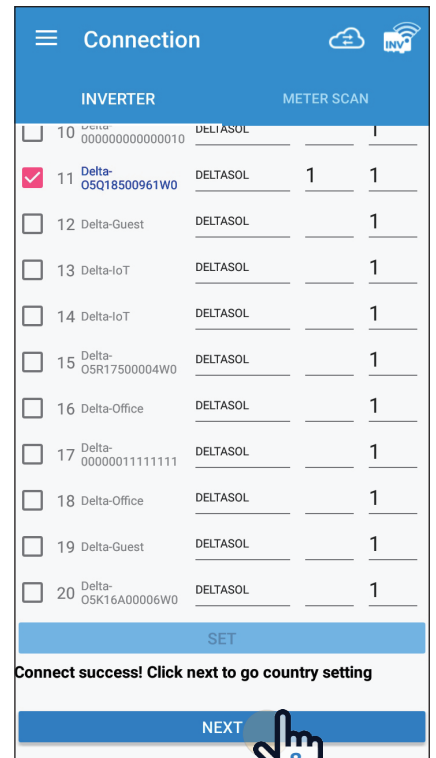
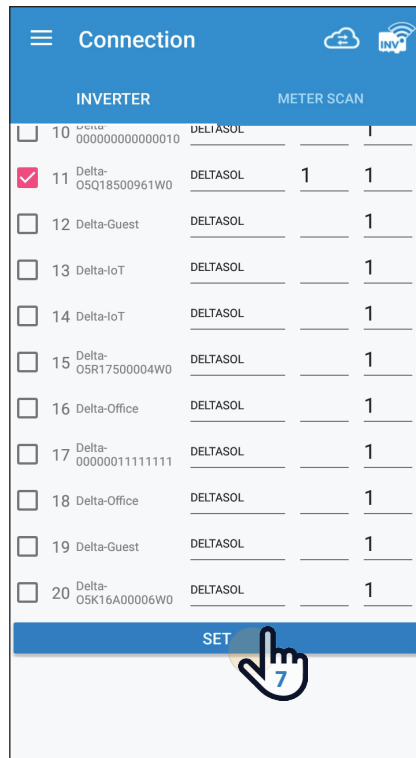
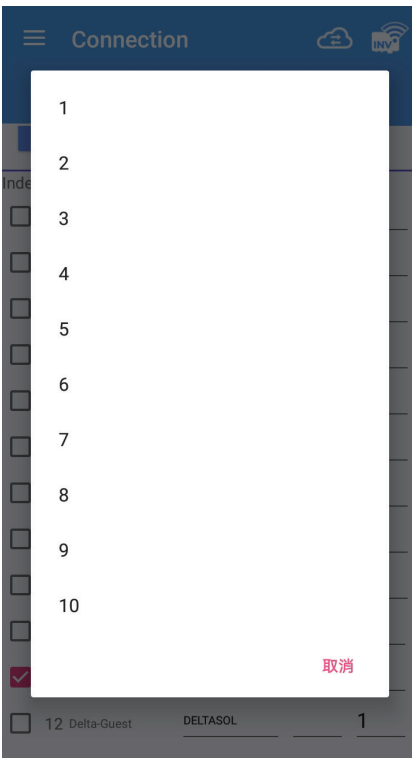
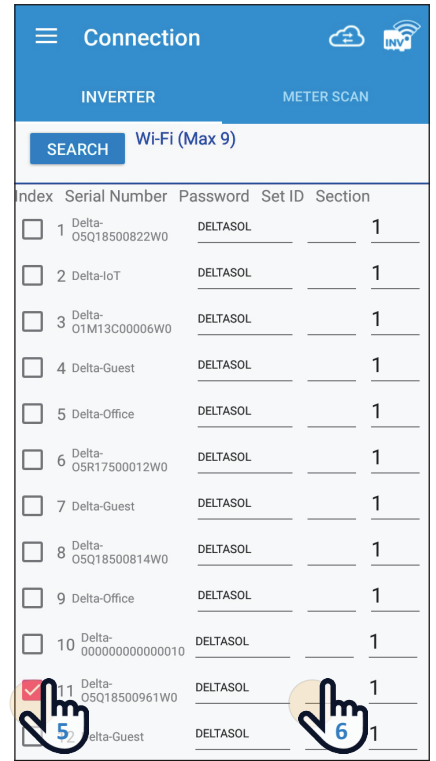
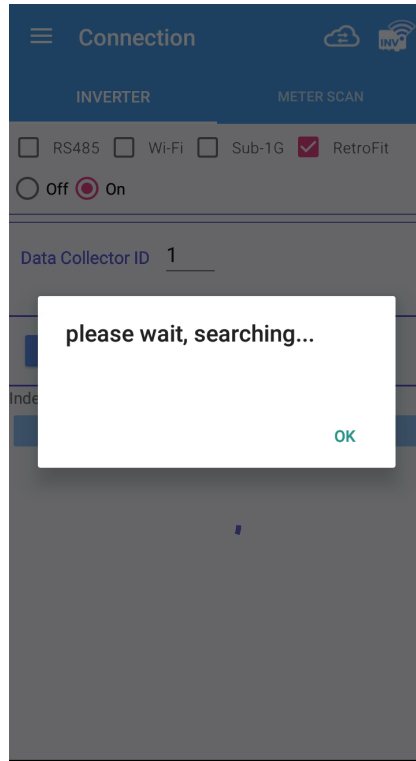
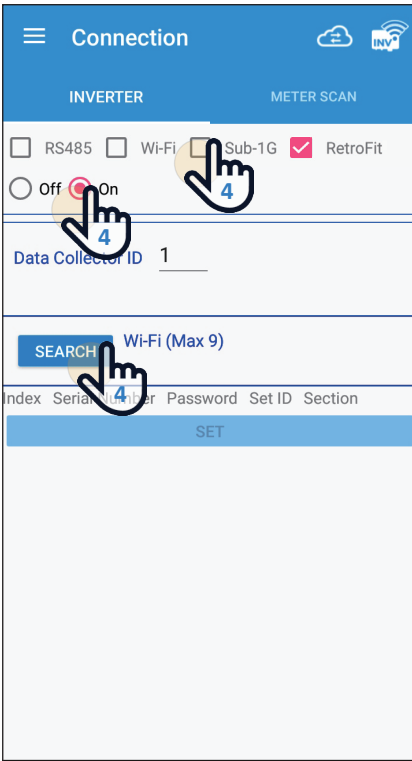

5.5.3rd party monitoring

RS-485 or Wi-Fi Inverter is set by operating the DC1 through the APP.

After the setting is completed, the third-party monitoring reads the external communication address of DC1 through Modbus to get the power generation data.

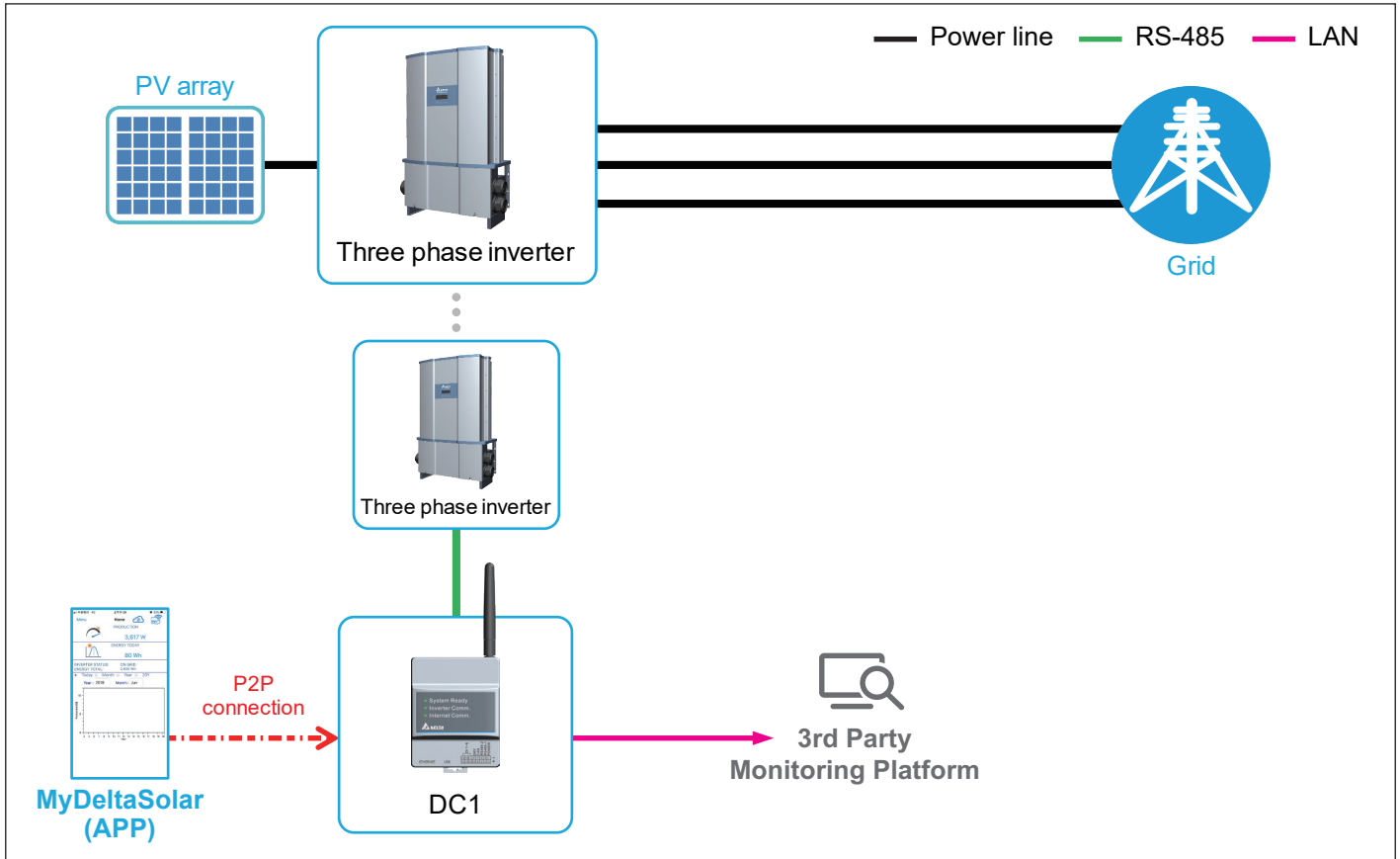

1. Access network page in menu bar.
2. Switch to "Network Setting" tab.
3. APP will popup a direction for user to choose whether to use Delta Solar Cloud or not. Select yes, APP will direct to register information page to start register process. Select no, APP will stay in this tab for user to setup network setting for third party monitor system.

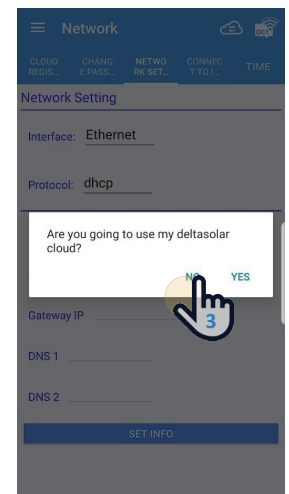
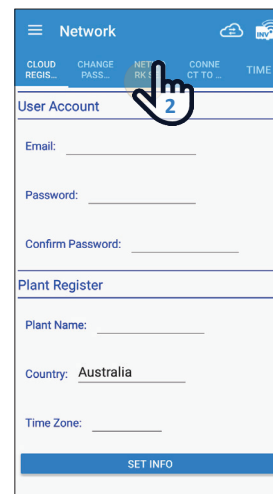

Network

CLOUD REGIS... CHANGE PASS... NETWORK SET... CONNECT TO I... TIME

Network Setting

Interface: Ethernet

Protocol: dhcp

IP Address: 169.254.1.2

Subnet Mask: 255.255.0.0

Gateway IP: _____

DNS 1: _____

DNS 2: _____

SET INFO

Static IP

1. IP Address: Set the IP to be specified for third-party monitoring.
2. Subnet Mask: Set the Mask to be specified for third-party monitoring.
3. Gateway IP: Set the Gateway to be specified for third-party monitoring.
4. DNS1: If DC1 has no external connection requirements, you do not need to fill it out. If yes, fill in the DNS that can be used.
5. DNS2: Same as DNS1, this is the alternate DNS.
6. Click set info to complete the setup.
7. Read the external communication address via this IP.

DHCP

1. If set to DHCP, third-party monitoring needs to set this DC1 IP.
2. Read the external communication address via this IP

6. Description of the page display (APP)

The APP displays a variety of information, such as the amount of power production, consumed, Feed-in or purchased, as well as the operating status of the Inverter.

 There are some slight differences between ios and Android's APP screen layout. This manual uses the Android system APP screen representative to explain.

6.1. Energy

The details on the performance of power production are displayed by respective units (date/ month/ year), graphs and lists. The following screens are available:

[Daily]

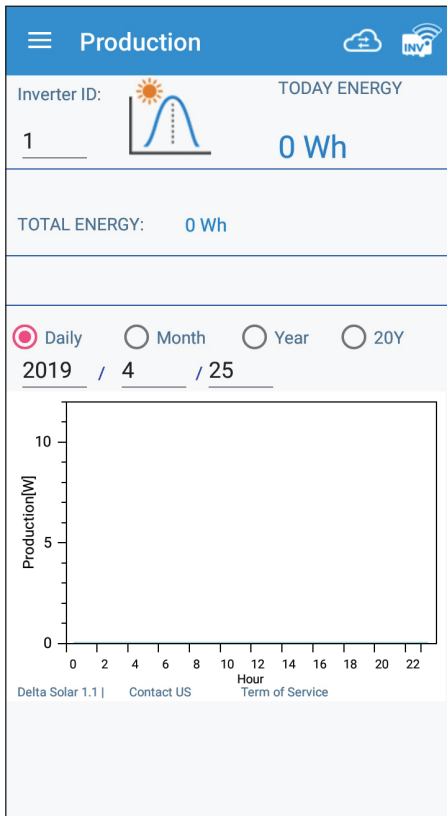

[Daily]

Display daily energy production per hour.

[Month]

Display month energy production per day.

[Year]

Display year energy production per.

[20Y]

Display 20-years energy production per year.

[Month]

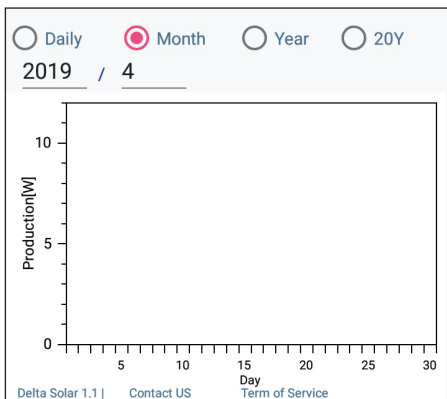

[Year]

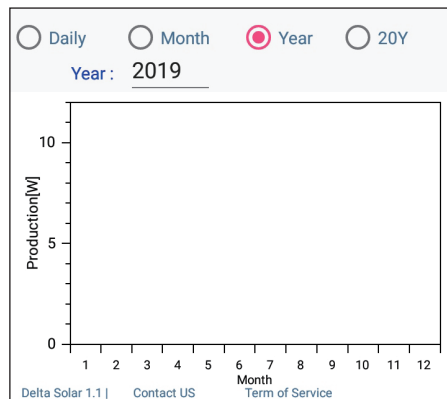

[20Y]

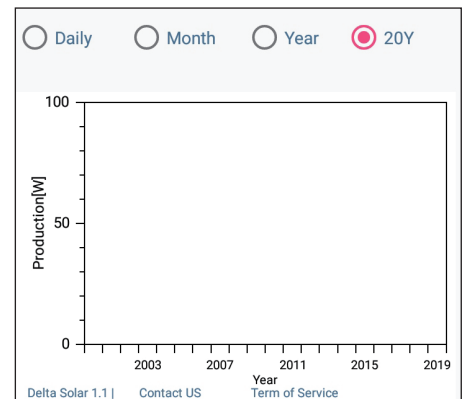

6.2. Infomation

Display basic information about DC1 and Inverter.

Infomation	
DC1_Info	
General Info	
DC1 : 01.06 Serial Number: SERIAL123456798 Connection Interface : Wifi	
Total Energy	
All Total Energy : 1387.5 kWh All Today Energy : 0 kWh All Total Power : 0 kW All Total VA : 0 kVar	
Inverter_Info	
Inverter ID: 1	
General Info	
Model Name: H5A_221 Serial Number: O5P18500057WB Connection Type : -- Today Energy : --	

[DC1_Info]

- General Info
- Total Energy

[Inverter_Info]

- Inverter ID
- General Info
- Input
- Output
- Operation Data
- String current
- De-rating Log
- FW version

6.3. History

Record the error status of the Inverter and the connection status.

History	
ERROR EVENTS LOG	HISTORY
ID: 1	
1. 2019/03/20 17:18:30 F23 - Internal Communication Fault(Display)	
2. 2019/03/22 23:30:21 F23 - Internal Communication Fault(Display)	
3. 2019/03/23 09:27:46 F23 - Internal Communication Fault(Display)	
4. 2019/03/25 06:23:46 F23 - Internal Communication Fault(Display)	
5. 2019/03/25 06:54:00 F23 - Internal Communication Fault(Display)	
6. 2019/03/28 10:20:33 F23 - Internal Communication Fault(Display)	
7. 2019/03/28 10:22:20 F23 - Internal Communication Fault(Display)	
8. 2019/03/28 10:28:06 F23 - Internal Communication Fault(Display)	
9. 2019/03/28 13:38:50 F23 - Internal Communication Fault(Display)	
10. 2019/03/29 22:09:38	

History	
ERROR EVENTS LOG	HISTORY
ID: All Page Number: 1	
1. 2019/04/25 10:48:34 ID-1-Connected	

[ERROR EVENTS LOG]

Display the error event record of the Inverter.

[HISTORY]

Record the connection records of each Inverter to DC1.

6.4.Connection

Please refer to the instructions in chapter 5.

6.5.Grid Setting

* To enter This page have to enter password. (for industrial authority)

You can modify or view the Grid settings of each inverter.

Grid Setting	
ID list:	1
Model:	H5A_221
Install Settings	
Country	Select Country
Insulation Mode	ON
RCMU	ON
Anti-islanding (EU)	ON
Maximum Power	4600
INSTALL SETTINGS SET	
SAME MODEL SET	
DC Injection	
Mode	ON
Trip Value	25
Trip Time	40
DC INJECTION SET	

[Install Settings]

- Country
- Insulation Mode
- RCMU
- Anti-islanding (EU)
- Maximum Power

[DC Injection]

- Mode
- Trip Value
- Trip Time

[Grid Settings - Connection]

- Reconnection Time

[Grid Settings - Voltage]

- VAC High Off
- VAC High On
- Vac High Off Time
- Vac Low Off
- Vac Low On
- Vac Low Off Time
- Vac High On Slow
- Vac High Off Slow Time
- Vac Low On Slow
- Vac Low Off Slow Time

[Grid Settings - Frequency]

- F High Off
- F High On
- F High Off Time
- Fac Low Off
- Fac Low On
- Fac Low Off Time
- Fac High Off Slow
- Fac High On Slow
- Fac High Off Slow Time
- Fac Low Off Slow
- Fac Low On Slow
- Fac Low Off Slow Time

[Ramp-up Power]

- Ramp-up Power

[Power Limit]

- Mode
- Set Point

[Power vs. Frequency]

- Mode
- Start Frequency
- Stop Frequency
- Recovery Frequency
- Gradient
- Statism
- Recovery Time

[P(V)]

- Mode
- Recovery Time (s)
- Lock-in Power (%)
- Lock-out Power (%)
- Lock-in Voltage
- Lock-out Voltage

[Reactive Power Control Mode]

- Mode

XXXXX SET

Only set for the selected Inverter

SAME MODEL SET

Inverter settings for all the same models

6.6.Network

* To enter This page have to enter password. (for industrial authority)

DC1 network related settings are introduced in this section.

[CLOUD REGISTER] : After entering the basic information of the user and the case, clicking [SET INFO] will lead to [CONNECT TO INTERNET] and continue to register with Cloud Server.

[CHANGE PASSWORD] : Change the WI-FI password for DC1 or Inverter. The password can be entered by yourself or the same as on the cloud server.

[NETWORK SETTING] : DC1 network settings, set DC1 according to the network environment of the site

[CONNECT TO INTERNET] : Scan nearby APs, let DC1 connect to the Internet through the selected AP, and register CLOUD REGISTER information on the cloud server.

This page needs to enter at least one of the basic information of the CLOUD REGISTER page to enter

[TIME] : The manual time will be based on the selected time zone, click [SET INFO] to manually time DC1.

The automatic timing will be automatically timed according to the time server set by the user and the time interval of the time.

[CLOUD REGISTER]

[CHANGE PASSWORD]

[NETWORK SETTING]

[CONNECT TO INTERNET]

[TIME]

6.7.FW Update

* To enter This page have to enter password. (for industrial authority)

We can update DC1 and Inverter to the latest version of FW at any time through the function of FW Update.

[INVERTER FW UPDATE]

1. Select the Inverter to be updated
2. Click [GET FW TYPE LIST], and you will be prompted to connect to the Internet.
3. After the phone is connected to the network, select the FW version to be updated and download it.
4. After downloading the FW, click on [SINGLE FW UPGRADE] or [MULTIPLE FW UPGRADE].
At this time, you will be asked to connect to DC1.



If you click [SINGLE FW UPGRADE], only update the selected Inverter.
If you click [MULTIPLE FW UPGRADE], all Inverters of the same model as the selected Inverter will be updated.

5. After returning to DC1, click [SINGLE FW UPGRADE] or [MULTIPLE FW UPGRADE] to start updating Inverter.
6. APP shows that the update is complete

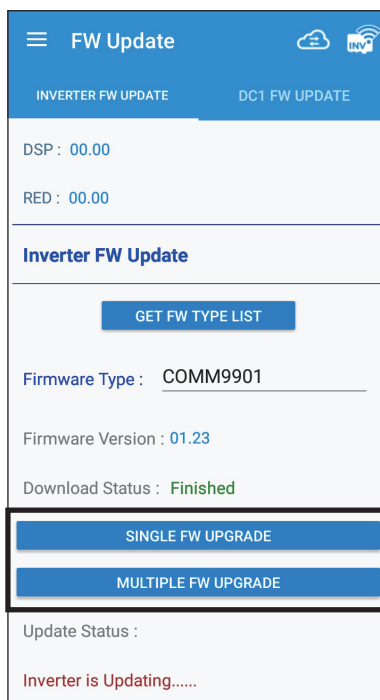
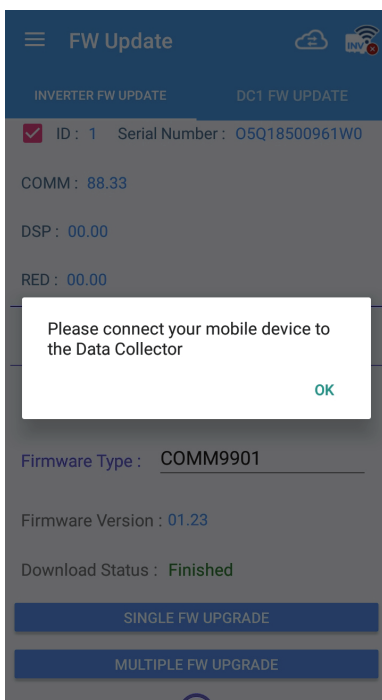
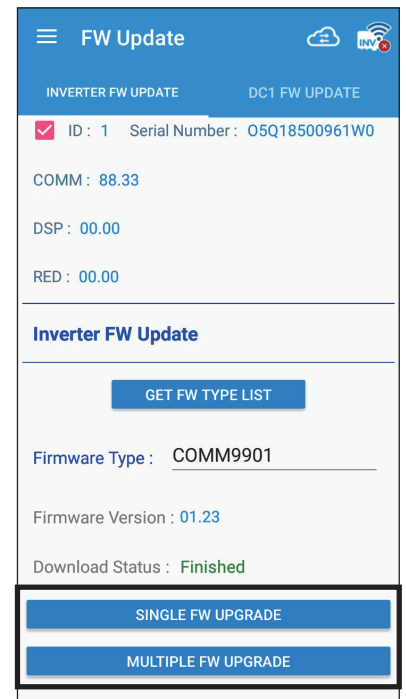
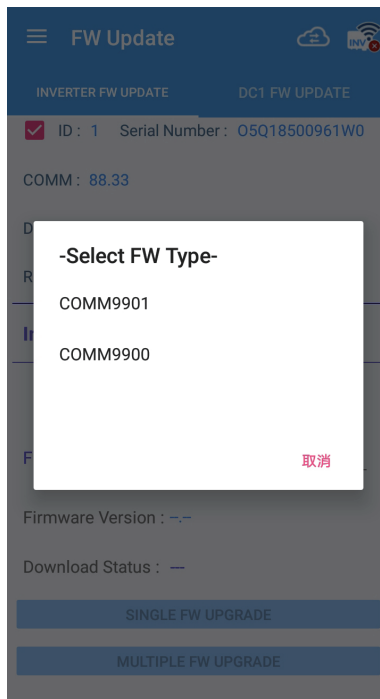
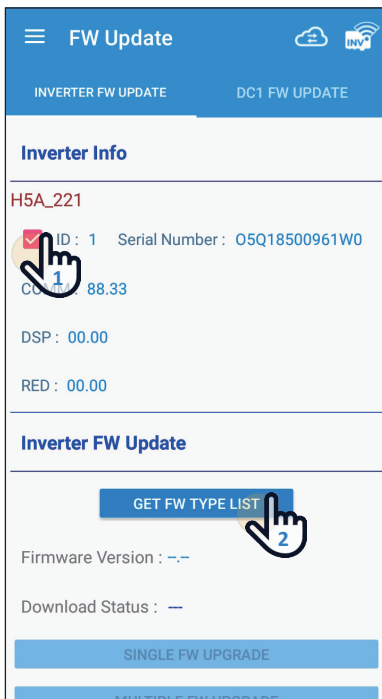

[DC1 FW UPDATE]

1. Click [DOWNLOAD DC1 FWFILE], and you will be prompted to connect to the internet.
2. After the phone is connected to the internet go back to APP, click [DOWNLOAD DC1 FWFILE] to start downloading the DC1 update file.
3. After downloading the update file, click [START DC1 FW UPDATE]. At this time, you will be asked to connect to DC1.
4. After returning to DC1, click [START DC1 FW UPDATE] to start updating DC1.
5. APP shows DC1 update completed and auto rebooted.

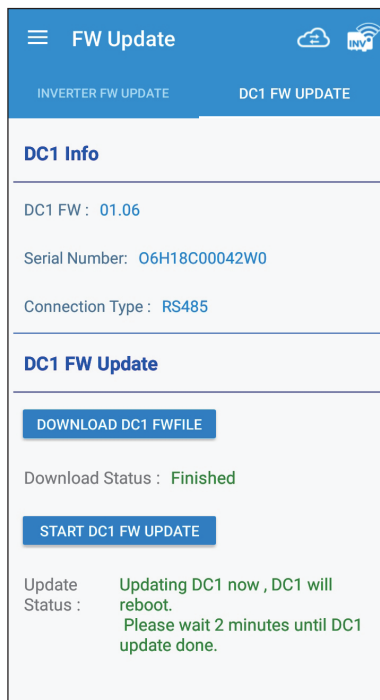
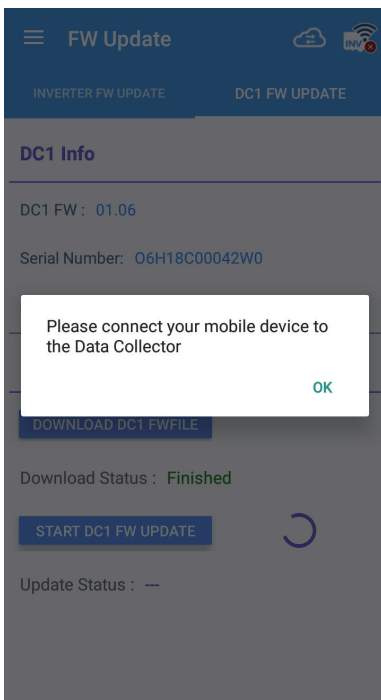
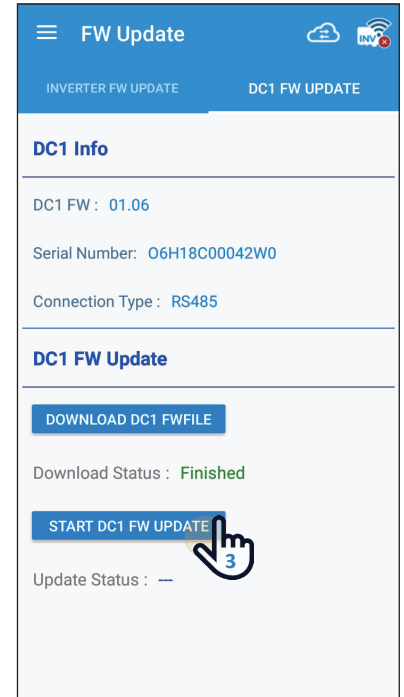
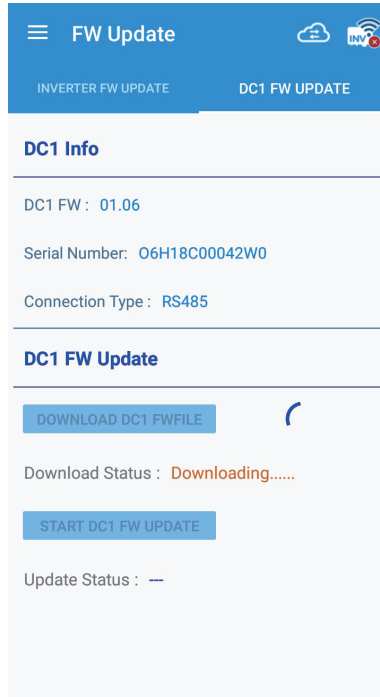
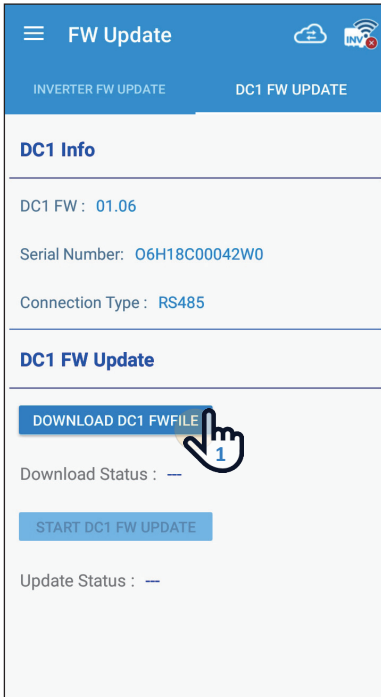

6.8.OTHER

* To enter This page have to enter password. (for industrial authority)

This section contains DRM0, PARTIAL/ZERP EXPORT, DRY CONTACT

[DRM0 (Digital input)]

1. Click [On] to turn on the function.
2. Follow below table to set the specific power limit value, you can check the percentage by DRM0(%) on the APP.

Short pins	Inverter behavior (standard)
16 & 15	N/A
16 & 14	Power de-rating to 30%
16 & 13	Power de-rating to 0%
16 & 12	Power de-rating to 100%
16 & 11	Power de-rating to 60%

Short pins	Inverter behavior (AU)
16 & 15	Disconnect from grid
16 & 14	Power de-rating to 75%
16 & 13	Power de-rating to 100%
16 & 12	Power de-rating to 50%
16 & 11	Power de-rating to 0%

[PARTIAL/ZERO EXPORT]

1. Click [On] to turn on the function.
2. Set the Sign capacity & PV capacity, DC1 will use the lower value as the power limit reference.
3. Set the Rate% base on power company or local regulation.

[DRY CONTACT]

1. Select the type of alert to trigger
2. When the Inverter triggers the selected alarm, DC1 will close dry contact relay to trigger external device.

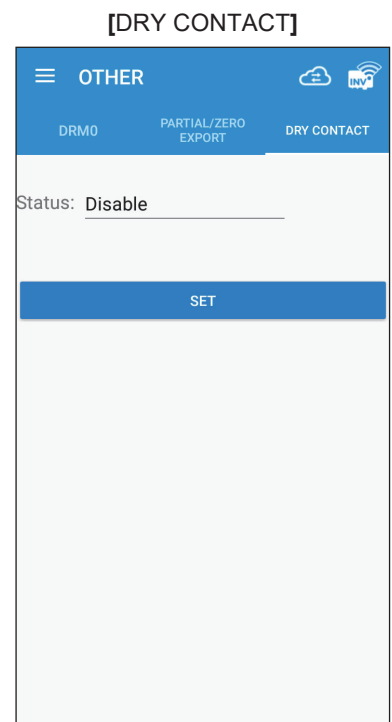
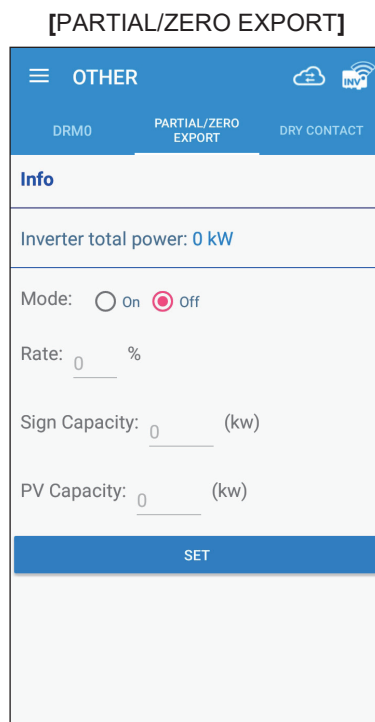
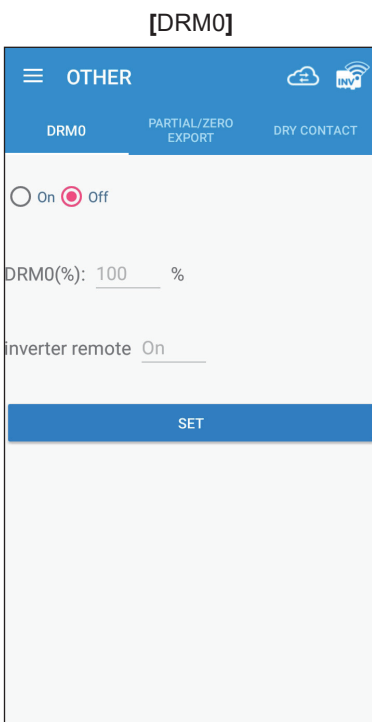

7. Description of the page display (Cloud)

We can see the Cloud page through the mobile phone, you can see the detailed power generation information, the case information and the settings can be modified.

7.1.Home Page



There are some slight differences between ios and Android's APP screen layout. This manual uses the Android system APP screen representative to explain.

The screenshot shows the Delta Cloud app interface. At the top, there's a blue header with the Delta logo (1), a cloud icon (2), and a user menu (4). Below the header, there's a 'TODAY ENERGY' section (5) showing 0.000 kWh today and a total of 821.698 kWh. A navigation bar (6) allows switching between 'TODAY', 'MONTH', 'YEAR', and '20 YEARS'. Below this is a bar chart showing production (0 kWh) over a 20-day period. At the bottom, there are two plant cards (7) for 'pi0403 Canberr...' and 'qwq Canberr...', both showing 0.000 kWh. A 'MY SOLAR' menu (3) is visible on the right, containing 'Support', 'Products', and 'Contact Us'. A 'USER' menu (4) is also shown, containing 'Edit Password' and 'Sign Out'.

- ① DELTA logo
Click to return to the main page
- ② Cloud icon
Click to return to the APP main page
- ③ Function menu
View each case, introduce Delta products and contact us
- ④ USER menu
Edit password or Sign out
- ⑤ Power generation
Show today's power generation and total power generation
- ⑥ Power generation map
Display different power generation maps according to the selected time interval
- ⑦ Set up the Plant
Display the name of each plant and the amount of power generated

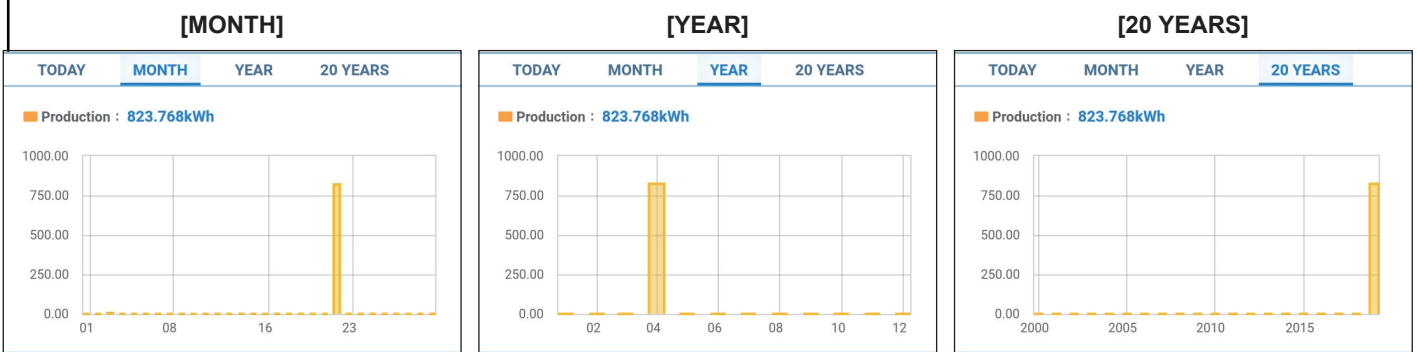

7.2.MY SOLAR

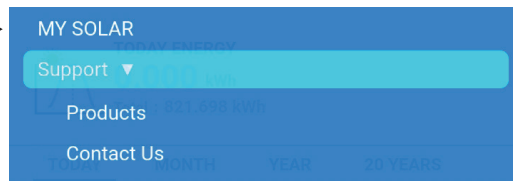
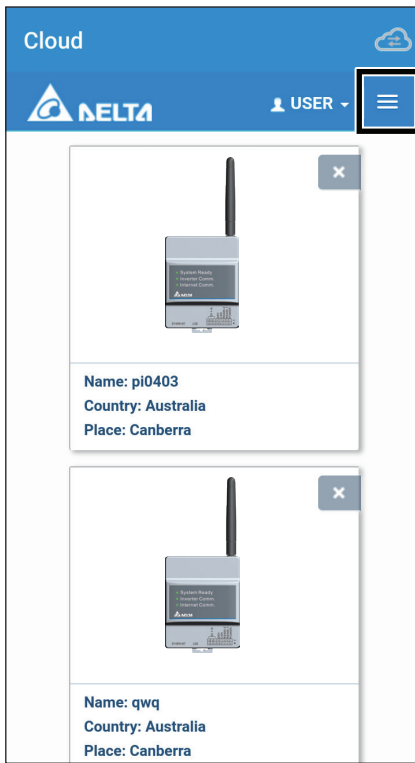

Click MY SOLAR, you can individually view the detailed power generation information of the plant.

[ENERGY - PLANT]

The total power generation of the inverter under the Plant

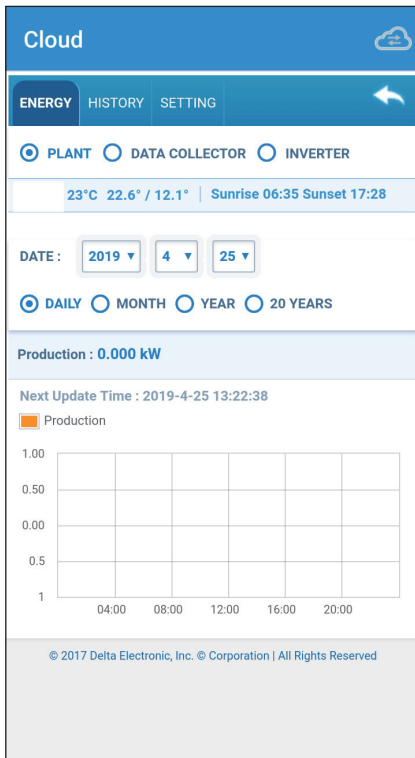

[ENERGY - DATA COLLECTOR]

According to the selected DATA COLLECTOR shows the total power generation of the Inverter under this DATA COLLECTOR

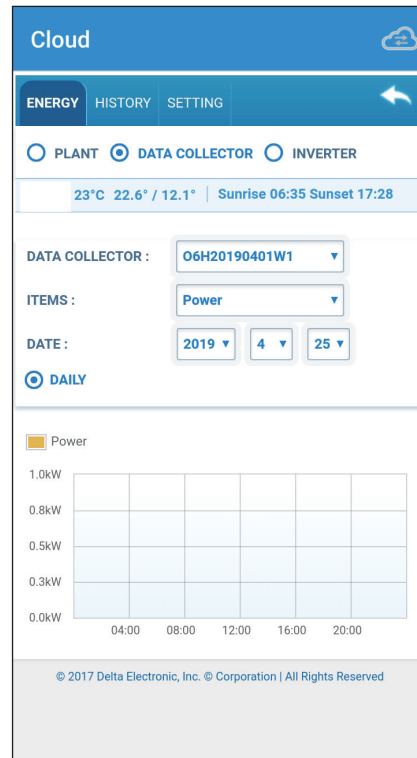

[ENERGY - INVERTER]

According to the selected Inverter show the total power generation for this or all inverters.

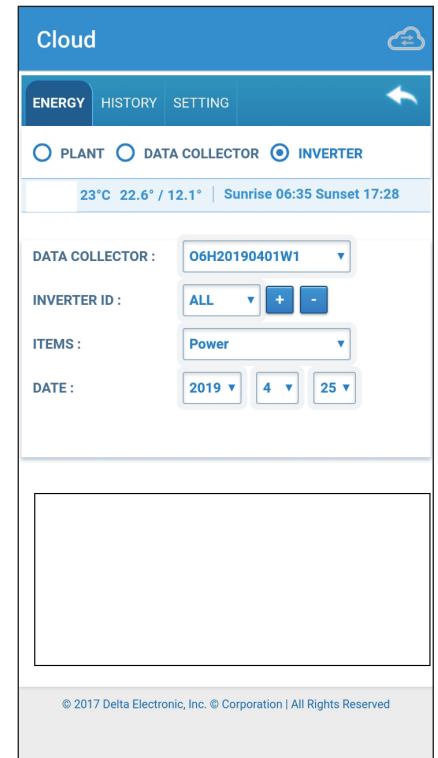

[HISTORY - PLANT]

Display when this PLANT started

Cloud

ENERGY HISTORY SETTING

PLANT DATA COLLECTOR INVERTER

PLANT NAME : pi0403

ITEMS : Startup

Plant Name	Time
pi0403	2019-04-03 15:45:56

© 2017 Delta Electronic, Inc. © Corporation | All Rights Reserved

[HISTORY - DATA COLLECTOR]

Display start time or disconnection time of selected DATA COLLECTOR

Cloud

ENERGY HISTORY SETTING

PLANT DATA COLLECTOR INVERTER

DATA COLLECTOR : O6H20190401W1

ITEMS : Startup

Model	Time
R3	2019-04-03 15:45:56

© 2017 Delta Electronic, Inc. © Corporation | All Rights Reserved

[HISTORY - INVERTER]

Display the startup time of the selected Inverter or the time of each EVENT

Cloud

ENERGY HISTORY SETTING

PLANT DATA COLLECTOR INVERTER

DATA COLLECTOR : O6H20190401W1

ITEMS : Event

INVERTER ID : ALL

Inverter ID	Time	Event
-------------	------	-------

© 2017 Delta Electronic, Inc. © Corporation | All Rights Reserved

[SETTING - PLANT]

PLANT Settings

Cloud

ENERGY HISTORY SETTING

PLANT DATA COLLECTOR INVERTER

PLANT NAME : pi0403

Select File Upload

COUNTRY : Australia

CITY : Canberra

TIMEZONE : +10

LATITUDE : -35.281960

LONGITUDE : 149.105380

CURRENCY : USD

TARIFF : 5.4321

FAULT ERROR

Cloud

LONGITUDE : 149.105380

CURRENCY : USD

TARIFF : 5.4321

ALARM : FAULT ERROR

WARNING

EMAIL 1 : E-mail@example.com

EMAIL 2 : E-mail@example.com

EMAIL 3 : E-mail@example.com

SHARE PLANT WITH SPECIFIC PEOPLE

+ Add

test@t.t

Apply

© 2017 Delta Electronic, Inc. © Corporation | All Rights Reserved

[Plant sharing]

plant owner can easily share plant information to every one.

Please Enter Delta Solar Account For Plant Sharing

EMAIL : user@test.com

(share energy info. and history of plant with specific people)

Close Send

[SETTING - DATA COLLECTOR]

DATA COLLECTOR settings

[SETTING - INVERTER]

Inverter settings

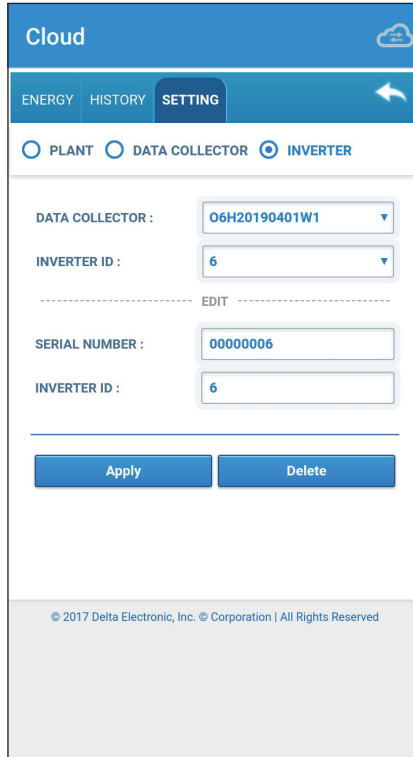
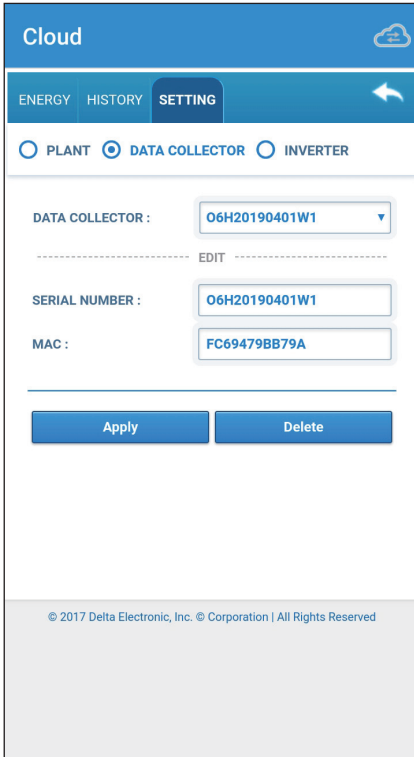

7.3.Products

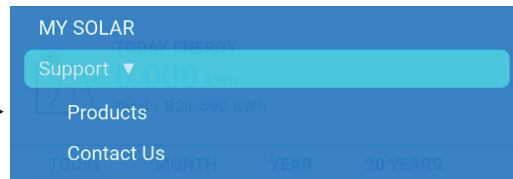

Introducing Delta's INVERTER, METER and MONITOR

7.4. Contact Us

Cloud

DELTA

USER

CONTACT US

E-mail Delta Customer Service

NAME :

E-MAIL :

REGION :

PHONE :

TITLE :

MESSAGE :

© 2017 Delta Electronic, Inc. © Corporation | All Rights Reserved

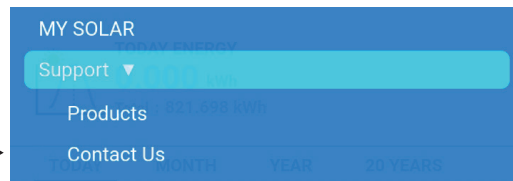

If you encounter any problems, please contact Delta Customer Service according to your location.

7.5. Edit Password

Cloud

DELTA

USER

EDIT YOUR PASSWORD

PASSWORD :

NEW PASSWORD :

- 8-16 characters
- At least one number
- At least one letter

CONFIRM PASSWORD :

© 2017 Delta Electronic, Inc. © Corporation | All Rights Reserved

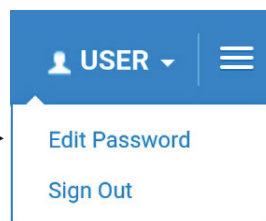

[Edit Password]
Length limit 8-16 yards
At least one number
At least one letter

8. When Something Seems Wrong (Troubleshooting)

8.1. Error Displays



When a problem occurs, confirm the Error message from the [ERROR EVENTS LOG] page of [History].



Details can be verified in the “ERROR EVENTS LOG” pages.
Refer to the Manual of the Inverter for details on the error codes.

8.2.Troubleshooting

Responsive actions that should be taken in cases where the following symptoms occur are described.

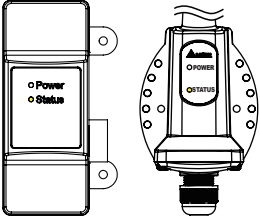
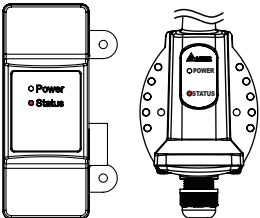
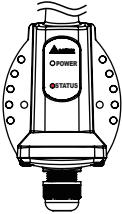
Symptom	Verification details	Responsive action
 <p>System ready light is red</p>	DC1 is booting	Please wait two minutes for the boot to complete
 <p>Inverter comm light is continuously flashing green light</p>	DC1 is Searching or Setting inverters.	Please wait for 2-10 minutes for Inverter to search or set up.
 <p>Internet light constant</p>	DC1 does not connect to internet	Please go to the NETWORK page to set network. For detailed setting process, please refer to section 6.6.
 <p>The LED Light of 'Status' flashes slow and changing color between green and yellow</p>	N1 does not connect to Data Collector N2 does not connect to Inverter	Please confirm if N1 is assembled with Data Collector/ Please confirm if N2 is adapted to Inverter.
 <p>The LED Light of 'Status' turns red and slow flashing</p>	N1 or N2 is booting	Please wait a minutes for the boot to complete.
 <p>The LED Light of 'Status' turns red and fast flashing</p>	Initialize N2's RF module failed when connecting to an inverter.	Please confirm if there is a connection between N2 and Inverter. if not, refer the figure in Chapter 2 and connect each wire to the communication card of the Inverter correctly.

8.3. Error dialog display

The following explains the case where the following error dialog is displayed during operation.

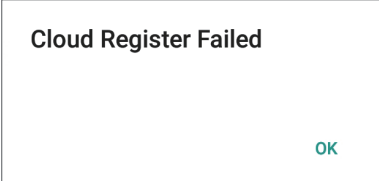
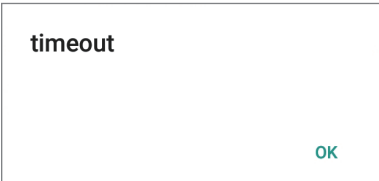
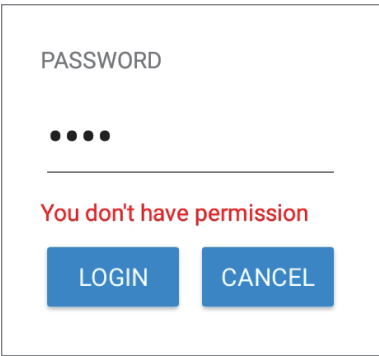
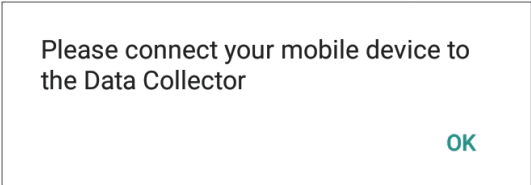
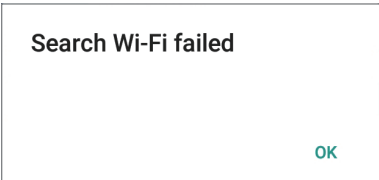
Error indication	Contents	Workaround
	Register to cloud server fail	<ol style="list-style-type: none"> 1. Please confirm whether this DC1 has been registered on the cloud. 2. Please confirm if Inverter has been registered on the cloud. 3. Please confirm if DC1 has internet connection. 4. Please confirm that the user account password is correct.
	Set wifi inverter time out	<ol style="list-style-type: none"> 1. Please confirm the communication quality between DC1 and inverter. 2. Please confirm if Inverter has started. 3. Please confirm if the smartphone is connected to DC1.
	Insufficient permission warning message	Please enter the correct permission password.
	User is not connected to DC1	Please go to the smartphone WI-FI page and reconnect to DC1.
	DC1 scan Inverter fail	DC1 may have a short weak signal. Please retry the scan.

Error indication	Contents	Workaround
<div data-bbox="156 250 604 430" style="border: 1px solid black; padding: 5px;"> <p>Please connect your mobile device to the Data Collector. When the LED turns green. Wi-Fi connection is available.</p> <p style="text-align: right; color: green;">OK</p> </div>	<p>User is not connected to Data Collector</p>	<p>Please go to the smartphone WI-FI page and reconnect to Data Collector.</p>
<div data-bbox="156 528 604 685" style="border: 1px solid black; padding: 5px;"> <p>Please make sure N1 is correctly adapted to Data Collector</p> <p style="text-align: right; color: green;">OK</p> </div>	<p>N1 is not correctly assembled with Data Collector</p>	<p>Please confirm if N1 is assembled with Data Collector. If yes, re-assembled them again, please.</p>
<div data-bbox="156 777 604 927" style="border: 1px solid black; padding: 5px;"> <p>Scan Quality failed</p> <p style="text-align: right; color: green;">OK</p> </div>	<p>Scanning the quality of communication band is failed</p>	<p>Please confirm the LED light color of 'Status'. If the light color is red and flashing slowly, it means that the SUB_1G module initializing is not ready. Please wait a minute until the light color turns to green.</p>
<div data-bbox="156 1043 604 1240" style="border: 1px solid black; padding: 5px;"> <p>Cloud Register Failed</p> <p style="text-align: right; color: green;">OK</p> </div>	<p>Registering to Cloud is failed</p>	<ol style="list-style-type: none"> 1.Please confirm whether this DC1 has been registered on the cloud. 2.Please confirm if Inverter has been registered on the cloud. 3.Please confirm if DC1 has an Internet connection. 4.Please confirm that the user account password is correct.

9. Specifications

ELECTRONIC SPEC		PPM DC1_100
Operating voltage range	9Vdc ~ 25Vdc (power port, can be supplied from inverter), 5Vdc (Micro USB)	
Power Consumption	5 Watt	
COMMUNICATION		
Wired	RS-485/ Ethernet	
Wireless	Internal Wi-Fi Module 802.11a/b/g/n	
REGULATION		
Safety Standard	EN 61010-1, CE compliance	
Emission (EMI)	EN 300 328, LP0002, Part 15C, Telec T66	
Immunity(EMS)	EN 301 489-1/-17, EN 55024, EN 55032, FCC Part 15B	
CONNECTION		
I/O Port	2 pin terminal block for Power Port 4 pin terminal block for RS-485 2 pin terminal block for Can Bus 2 pin terminal block for Dry Contact 6 pin terminal block for digital inputs RJ-45 connector for Ethernet USB Port for data storage	
GENERAL INFORMATION		
LED Display	System Ready, Inverter Comm., Internet Comm.	
Operation temperature	-25°C ~ 55°C	
Relative humidity	30% ~ 85%	
Dimension (WxHxD)	72 x 90 x 55 mm	
Weight	157g (with Wi-Fi antenna)	

Appendix - N1

1. Functions of Parts

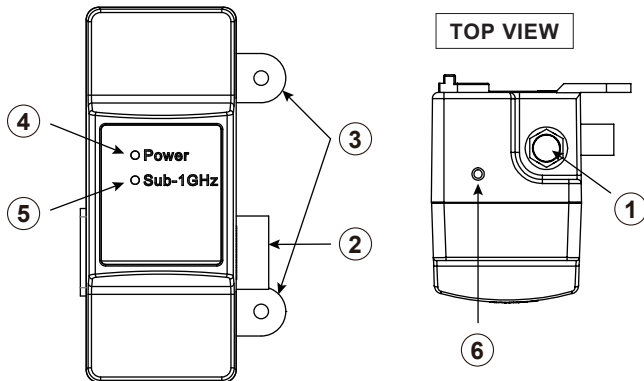

	Part	Function
①	Antenna	Wi-Fi Single
②	External Comm. Connector	Connection to Data Collector
③	Fixed Point	Fix with Data Collector
④	Power LED	Power ON/OFF
⑤	Sub-1G LED	Sub-1G status
⑥	Reset Button	Reset to Default

2. LED Description

Status	Red LED	Yellow LED	Green LED	Description
Upgrade N1	Slow Flash	OFF	Slow Flash	Update N1 card.
Upgrade Module	Slow Flash	Slow Flash	OFF	Update RF module.
No Host	OFF	Slow Flash	Slow Flash	No back-end devices are connected.
Module Not Ready	Slow Flash	OFF	OFF	Waiting for module initialization.
Ext. Idle	OFF	ON	OFF	No Ext. data transmission for more than 300 seconds.
Int. Idle	OFF	Slow Flash	OFF	No Int. data transmission for more than 600 seconds.
Normal	OFF	OFF	ON	Connecting.

Power	Light Green LED		Description
	ON		When the device is receiving power.
	OFF		Powered off.

Reset Button	Red LED	Yellow LED	Green LED	Description
Push 5~10s	ON	Slow Flash	OFF	Reset RF.
Push 15~20s	ON	Fast Flash	OFF	Reset RF & Freq. = Default Band.
Others	ON	OFF	OFF	Invalid operation.

3. Specifications

ELECTRONIC SPEC	N1
Operating voltage range	5 Vdc
Power Consumption	2 Watt
COMMUNICATION	
Wired	RS-485
Wireless	Sub-1G
REGULATION	
Safety Standard	EN 61010-1, CE compliance
Emission (EMI)	EN 300 220 (below 1G), EN 50385, LP0002, Part 15C, Telec T66
Immunity(EMS)	EN 301 489-1/-3, EN 55024, EN 55032, FCC Part 15B
CONNECTION	
I/O Port	6 pin terminal block (2 x RS485, 4 x GPIO)
GENERAL INFORMATION	
LED Display	Power, Sub-1GHz
Operation temperature	-25°C ~ 55°C
Relative humidity	30% ~ 85%
Dimension (WxHxD)	48 x 309 x 55 mm
Weight	150g

Appendix - N2

1. Functions of Parts

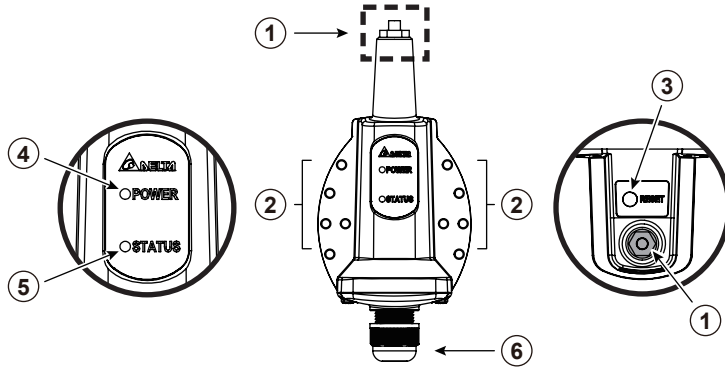

	Part	Function
①	Antenna	Wi-Fi Single
②	Fixed Point	Fix on inverter
③	Reset Button	Reset to default
④	Power LED	Power ON/OFF
⑤	Status LED	Sub-1G Status
⑥	Cable Gland	Avoid the moisture into machine

2. LED Description

Status	Red LED	Yellow LED	Green LED	Description
Upgrade N2	Slow Flash	OFF	Slow Flash	Update N2 card.
Upgrade Module	Slow Flash	Slow Flash	OFF	Update RF module.
No Host	OFF	Slow Flash	Slow Flash	No back-end devices are connected.
Module Not Ready	Slow Flash	OFF	OFF	Waiting for module initialization.
Module Init Fail	Fast Flash	OFF	OFF	Initialize RF module failure when connecting to inverter.
Ext. Idle	OFF	ON	OFF	No Ext. data transmission for more than 300 seconds.
Int. Idle	OFF	Slow Flash	OFF	No Int. data transmission for more than 600 seconds.
Data Transfer	OFF	OFF	Fast Flash	Data transfer in progress.
Normal	OFF	OFF	ON	Connecting.

Power	Light Green LED		Description
	ON		When the device is receiving power.
	OFF		Powered off.

Reset Button	Red LED	Yellow LED	Green LED	Description
Push 5~10s	ON	Slow Flash	OFF	Reset RF.
Push 15~20s	ON	Fast Flash	OFF	Reset RF & Freq. = Default Band.
Others	ON	OFF	OFF	Invalid operation.

