

The power behind competitiveness

# Delta UPS - Amplon Family

GAIA Series, Single Phase  
1/2/3 kVA

User Manual

[www.deltapowersolutions.com](http://www.deltapowersolutions.com)



## Save This Manual

This manual contains important instructions and warnings that you should follow during the installation, operation, storage and maintenance of this product. Failure to heed these instructions and warnings will void the warranty.

Copyright © 2012 by Delta Electronics Inc. All Rights Reserved. All rights of this User Manual ( "Manual" ), including but not limited to the contents, information, and figures are solely owned and reserved by Delta Electronics Inc. ( "Delta" ). The Manual can only be applied to the operation or the use of this product. Any disposition, duplication, dissemination, reproduction, modification, translation, extraction, or usage of this Manual in whole or in part is prohibited without the prior written permission of Delta. Given that Delta will continuously improve and develop the product, changes may be made to the information in this Manual at any time without obligation to notify any person of such revision or changes. Delta will make all possible efforts to secure the accuracy and the integrity of this Manual. Delta disclaims any kinds or forms of warranty, guarantee, or undertaking, either expressly or implicitly, including but not limited to the completeness, faultlessness, accuracy, non-infringement, merchantability or fitness for a particular purpose of the Manual.

---

## CONTENTS

---

<b>IMPORTANT SAFETY INSTRUCTIONS .....</b>	<b>2</b>
<b>CHAPTER 1 INTRODUCTION.....</b>	<b>5</b>
1-1 THEORY OF OPERATION.....	5
1-2 FEATURE .....	7
1-3 ANNOTATION AND SYMBOL.....	9
<b>CHAPTER 2 OPERATION .....</b>	<b>10</b>
2-1 OPERATION PANEL .....	10
<b>CHAPTER 3 INSTALLATION.....</b>	<b>14</b>
3-1 MOUNTING.....	14
3-2 CONNECTING THE BATTERY BANK.....	15
3-3 CONNECTING THE RS-232/DRY CONTACT .....	16
3-4 CONNECTING THE LOAD .....	17
3-5 CONNECTING TO UTILITY POWER.....	18
3-6 TURNING “ON” THE UPS .....	18
3-7 COLD START WHEN UTILITY POWER IS NOT PRESENT .....	18
3-8 UPS SELF-TEST .....	18
3-9 SILENCE FUNCTION.....	19
3-10 TURNING “OFF” THE UPS.....	19
3-11 IF CERTAIN ABNORMAL CONDITION OCCURS, THE UPS WILL SEND THE FOLLOWING MESSAGES: .....	19
3-12 DE-RATING POWER.....	20
3-13 UPS INTERNAL FAULT .....	21
<b>CHAPTER 4 COMMUNICATION INTERFACE .....</b>	<b>22</b>
4-1 RS232/ USB.....	23
4-2 DRY CONTACT .....	24
4-3 SNMP CARD .....	25
<b>CHAPTER 5 BATTERY REPLACEMENT.....</b>	<b>26</b>
5-1 BATTERY REPLACEMENT (SEE FIGURE 5-1).....	26
<b>CHAPTER 6 TROUBLESHOOTING .....</b>	<b>27</b>
<b>TECHNICAL SPECIFICATIONS.....</b>	<b>30</b>

## IMPORTANT SAFETY INSTRUCTIONS

Save These Instructions! This manual contains important instructions for our UPS that should be followed during installation and maintenance of the UPS and batteries.

The UPS has an internal battery supply. The nominal rating voltage of battery supply is 24V, 48V, 72V for 1KVA, 2KVA and 3KVA UPS individually no matter what model of the 1KVA, 2KVA and 3KVA UPS.

To reduce the risk of electric shock, install this UPS in a temperature and humidity controlled indoor area free of conductive contaminants. Ambient temperature must not exceed 40°C (104°F)

The AC output of the UPS need a disconnect switch such as a breaker which has to be provided by others.

The over-current protection for the output AC circuit has to be provided by others. All of our UPS have an electronic protection of AC output short circuit.

Servicing of batteries should be performed or supervised by personnel who are knowledgeable about batteries and the required precautions. Keep unauthorized personnel away from batteries.

When replacing batteries, replace with the same number of the: LC-R129 (PANASONIC), REW45-12 (YUASA), HR9-12 (BB), and HR1234F2 (CSB).

**CAUTION!** Do not dispose of battery or batteries in fire. The battery may explode.

**CAUTION!** Do not open or mutilate the battery or batteries. Released electrolyte is harmful to the skin and eyes. It may be toxic.

**CAUTION!** A battery can present a risk of electrical shock and high short circuit current. The following precautions should be observed when working on batteries:

Remove watches, rings, or other metal objects.

Use tools with insulated handles.

Wear rubber gloves and boots.

Do not lay tools or metal parts on top of batteries.

Disconnect charging source prior to connecting or disconnecting battery terminals.

Determine if the battery is inadvertently grounded. If inadvertently grounded, remove source of ground. Contact with any part of a grounded battery can result in electrical shock. The likelihood of such shock will be reduced if such grounds are removed during installation and maintenance (applicable to UPS and a remote battery supply not having a grounded supply circuit).

This UPS contains batteries, which are potentially hazardous to user, even when the UPS is not connected to the utility power.

**[1KVA MODEL] Federal Communications Commission Interference Statement**

This equipment has been tested and found to comply with the limits for a Class B digital device, pursuant to Part 15 of the FCC Rules. These limits are designed to provide reasonable protection against harmful interference in a residential installation. This equipment generates, uses and can radiate radio frequency energy and, if not installed and used in accordance with the instructions, may cause harmful interference to radio communications. However, there is no guarantee that interference will not occur in a particular installation. If this equipment does cause harmful interference to radio or television reception, which can be determined by turning the equipment off and on, the user is encouraged to try to correct the interference by one of the following measures:

- **Reorient or relocate the receiving antenna.**
- **Increase the separation between the equipment and receiver.**
- **Connect the equipment into an outlet on a circuit different from that to which the receiver is connected.**
- **Consult the dealer or an experienced radio/TV technician for help.**

FCC Caution: To assure continued compliance, (example-use only shielded interface cables when connecting to computer or peripheral devices). Any changes or modifications not expressly approved by the party responsible for compliance could void the user's authority to operate this equipment.

This device complies with Part 15 of the FCC Rules. Operation is subject to the following two conditions: (1) this device may not cause harmful interference, and (2) this device must accept any interference received, including interference that may cause undesired operation.

**[2, 3KVA MODELS]** Federal Communications Commission Interference Statement  
This equipment has been tested and found to comply with the limits for a Class A digital device, pursuant to Part 15 of the FCC Rules. These limits are designed to provide reasonable protection against harmful interference when the equipment is operated in a commercial environment. This equipment generates, uses and can radiate radio frequency energy and, if not installed and used in accordance with the instructions manual, may cause harmful interference to radio communications. Operation of this equipment in a residential area is likely to cause harmful interference in which case the user will be required to correct the interference at his own expense.

# CHAPTER 1 INTRODUCTION

## 1-1 Theory of operation

The main topology of the UPS consists of bypass path, AC-DC converter, DC-AC inverter, battery charger, DC-DC converter, control circuit and detection circuit. Moreover, the intelligent power management software is also optional. The function and efficiency are superior to the traditional UPS.

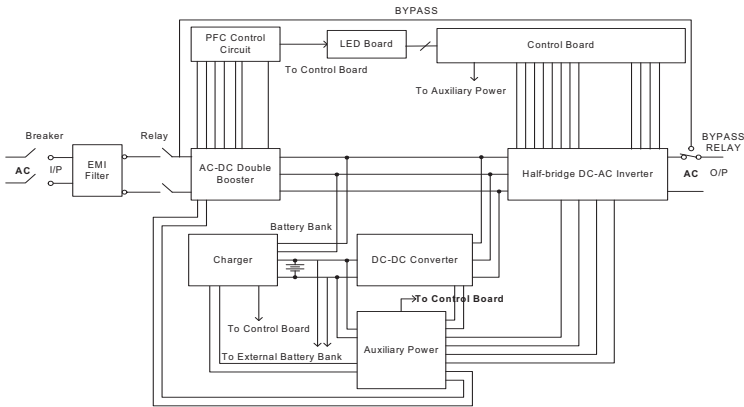

Figure 1-1 Hardware block diagram of the UPS

The UPS operation is described as below:

When the utility power is applied into the UPS, it was divided into two ways after going through the breaker and EMI filter. One way is connected to AC-DC converter which converts the utility AC power into a DC voltage which is called DC-BUS voltage then divides into two paths. One path goes to charger which converts the DC-BUS voltage into a proper DC voltage to charge the UPS battery. The other path goes into DC-AC half bridge inverter. The other way works as a bypass path. The bypass relay near the output will choose either the bypass path or inverter output. In general, the UPS will internally do the self-diagnosis. If there is no problem, the bypass relay will choose the inverter output. This is so called “**ON-LINE mode**”.

In case the utility power fail, the AC-DC converter and charger will be off duty. The DC-DC converter works and converts the battery voltage into DC-BUS voltage. The DC-AC inverter converts the DC-BUS voltage into AC voltage. This is so called **“ON-BATTERY mode”**.

The auxiliary power circuit supplies the designated power to all the control circuits. Because the DC-AC inverter is always working, the DC-DC converter can work rapidly and replace the AC-DC converter while the utility power fails. Furthermore, the bypass relay continuously keeps in the position of inverter output to supply the regulated power for the load. There is no power failure to loading equipment.



## 1-2 Feature

---

The UPS, available in 1KVA, 2KVA and 3KVA, is an advanced on-line UPS providing reliable and consistent sine-wave quality power to vital equipment. It supports personal computers, networks, servers, telecommunication equipment and a variety of other facilities. With its outstanding protection features, the unit keeps your applications safe and running smoothly at all times.

### □ **High power density**

Other than traditional UPS adopting 0.7 output power factor, the UPS uses the latest technology and highest quality components giving output power factor up to 0.8. Compared to other UPS (1000VA/800W), these UPS series boosts a 12% more output power. This UPS with its compact size, generates higher power density thus giving convenience to the users. Moreover, through the use of advanced technology, the UPS efficiency increases to more than 87%. Compared with other traditional UPS with only 80 to 85% efficiency, this UPS produces greater electric power efficiency at less electric costs.

### □ **PFC (Power Factor Correction)**

With this function, the investment in the capacity of circuit breakers can be reduced, specially it will be highly regarded as an important feature in critical load applications.

### □ **Complete Protection**

On-line double conversion design, pure sine wave output and zero transfer time provide best protection. With a built-in surge, spike and line noise protection, the UPS prevents destructive hardware damage and extends system life. The EMI/RFI filtering design prevents electrical noise from affecting computer operation and data files. Besides, the UPS provides built-in Fax/Network cable (RJ11/RJ45) jacks protecting your hardware from surge, spikes and line-noise which travel along communication lines, therefore providing you a complete “back door” protection.

### □ **Intelligent design**

Integrated with a microprocessor, the UPS is able to perform intelligent functions. The UPS triggers over-voltage protection function and transfers to “On- Battery mode” even when utility voltage exceeds 275V. In addition, the UPS can accept large voltage variation of 130V to 275V. Wide input voltage range means less battery power usage frequency and longer battery life span. Besides, programmable outlet design, suitable for power management, is also

included in this unit.

□ **Considerate design**

Battery start function allows startup of the UPS even when there is no AC line available. In addition, the UPS which was shut down by remote control during power line blackout will restart automatically when AC power recovers. Using our automatic frequency sensing function to match input and output frequency, users don't need to set either 50Hz or 60Hz. Other features, such as UPS self-diagnosis and flexible external battery pack, are also included.

□ **Green function design**

The operation in sleeping mode is designed to just keep charging which saves the energy a lot.

□ **User friendly interface**

The UPS provides a variety of functions which meet users' needs. Users can instantly understand the status of the UPS via the informative LED display. Audible alarms, bar meters and status indicators, such as battery replace indication, UPS fault, line condition, overload etc. are simple and easy for user to understand. Moreover, users can simply reset the circuit breaker instead of having to replace a fuse in the event of output overload.

□ **Network Management**

Build-in communication interface port supporting RS232 and Dry contact protocols enhances the reliability and manageability of the UPS over all major operating systems, including Windows 95/ 98/ 2000/ NT/ XP/ Vista, Netware, UNIX, and others. Besides, the UPS also supports the **Simple Network Management Protocol** and **Hyper Text Transfer Protocol** via plugging a **SNMP/HTTP** adapter into the build-in **SNMP** slot.

## 1-3 Annotation and symbol

---

The two signs shown on the manual indicating important instruction need to be followed.



**Read before Operation**



**Maybe Dangerous/Follow Instructions**



**Protective grounding terminal: A terminal which must be connected to earth ground prior to making any other connection to the equipment.**



**This symbol indicates the word “phase”.**



**This symbol indicates the principal on/off switch is in the “ON” position.**



**This symbol indicates the principal on/off switch is in the “STAND-BY” position.**

---

# CHAPTER 2 OPERATION

## 2-1 Operation Panel

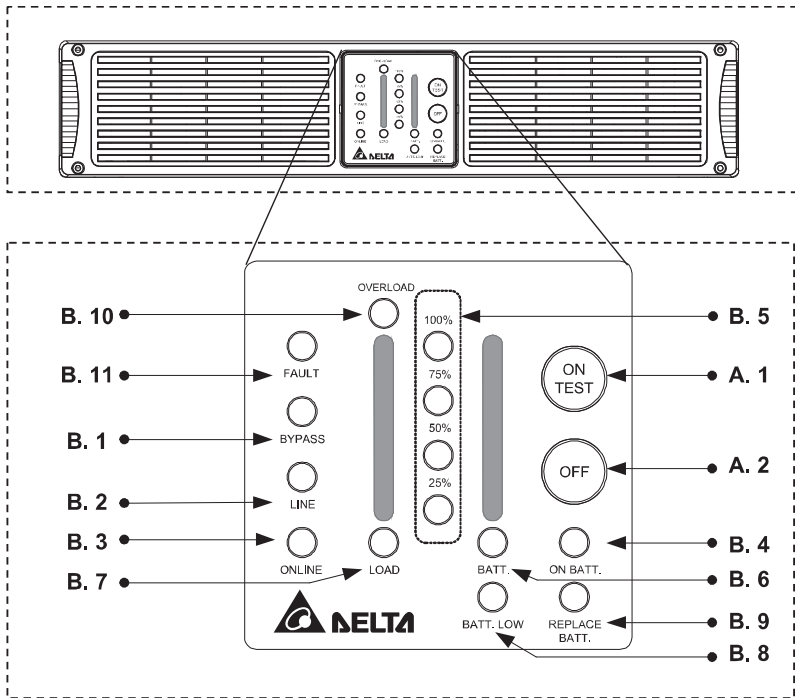

Figure 2-1 Operation Panel

## Operation Panel

### A. Button :

1. **ON/TEST Switch:** The button is used for turning on the UPS, it can also perform the battery test function in “**ON-LINE mode**”. In “**ON-BATTERY mode**”, this button can turn off the buzzer for silence.
2. **OFF Switch:** The button is used for turning off UPS.

### B. LED Display Status :

1. **Bypass:** This LED indicates that the UPS is in “**BYPASS mode**”.
2. **Line LED:** This LED indicates the condition of input line. If the input voltage is too low, too high, or out of frequency, this LED will flash. When line is blackout, this LED will light off.
3. **ON Line LED:** This LED indicates that the UPS is running in “**ON-LINE mode**”.
4. **ON Battery LED:** This LED indicates the UPS is running in “**ON-BATTERY mode**” (backup mode), the internal batteries will supply the power.
5. **Level LEDs:** The four LEDs indicate that the current battery capacity in “**ON-BATTERY mode**” or the current load level of the UPS in “**ON-LINE mode**”.
6. **Battery LED:** When this LED lights up, “Level LEDs” will show the current battery capacity.
7. **Load LED:** When this LED lights up, “Level LEDs” will show the load level of the UPS.
8. **Battery Low:** This LED indicates that the UPS is in the “Battery Low” condition.
9. **Battery Replace:** After Battery test, This LED indicates that the batteries are weak and it is suggested to the users to replace the batteries.
10. **Overload:** This LED indicates that the load level exceeds the rating, after a limited period of time, the UPS will transfer to “**BYPASS mode**” and this LED will still light on to alarm the user.
11. **Fault:** This LED indicates that the UPS is fault.

## Rear Panel

The rear panel is explained as follows: (Please refer to Figure 2-2.1 and 2-2.2)

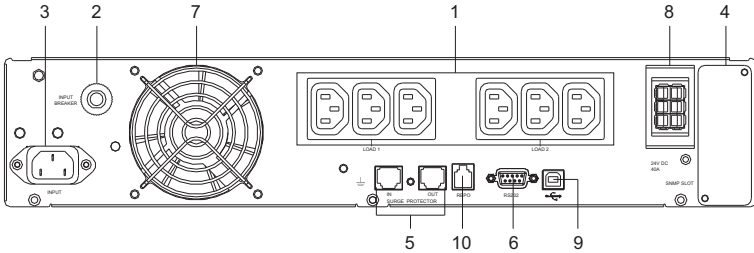

Figure 2-2.1 (1KVA Rear Panel)

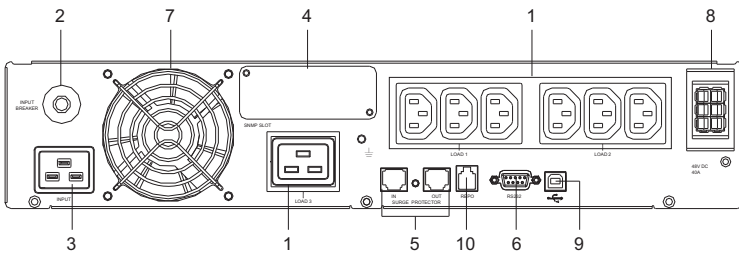

Figure 2-2.2 (2KVA & 3KVA Rear Panel)

1. **OUTPUT RECEPTACLES:** The UPS supplies AC power to the load.
2. **I/P BREAKER:** To prevent the UPS from damages caused by the high input current
3. **INPUT SOCKET:** AC input utility supplies power to the UPS via the socket.
4. **SNMP SLOT:** A SNMP adapter can be plugged in this port for managing the UPS on network. Please refer to section four for more detailed information. (Optional)
5. **TVSS (Transient Voltage Surge Suppressor) (RJ-45/RJ-11 SURGE PROTECTOR):** These connectors are used to prevent damages caused by surge, noise and spike traveling from the telephone or network line.

6. **COMMUNICATION INTERFACE (RS-232/DRY CONTACT):** The communication port is used to communicate PC and UPS. Please refer to section four for more detailed information.
7. **Fan:** DC fans for cooling purpose.
8. **External Batteries Connector:** Used for connecting external battery Bank to extend back up time.
9. **USB:** USB connector can be plugged in this port. The communication port is used to communicate PC and UPS.
10. **EPO (RJ11/Emergency power OFF):** When UPS is connected to RJ11 connector. It enables emergency Shutdown of UPS's inverter.

## CHAPTER 3 INSTALLATION

Before unpacking the UPS, check the packing box. If there is any visible damage, contact your dealer at once.

1. Any individuals with previous training should operate this unit.
2. This unit should be installed by service personnel.

The UPS package contains the following items. Please check if any items are missing. If there is any damage or anything missing, please immediately contact the dealer from whom you purchased the unit.

No.	Item	Quantity
1	UPS	1 pc
2	User Manual	1 pc
3	RS232 Cable	1 pc
4	Power Cord (GES102R200035 just has 2pcs of power cord)	3 pcs
5	Tower Stand	1 set
6	UPS Test Report	1 pc
7	Caution Letter	1 pc
8	Software CD: UPSentry Smart 2000	1 pc
9	Series Number Label	3 pcs
10	Bracket Ear	1 set

### 3-1 Mounting

#### 3-1-1 Enclosure Mounting

- Install the mounting bracket. See Figure 3-1.

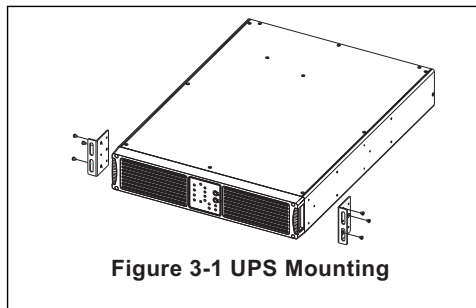
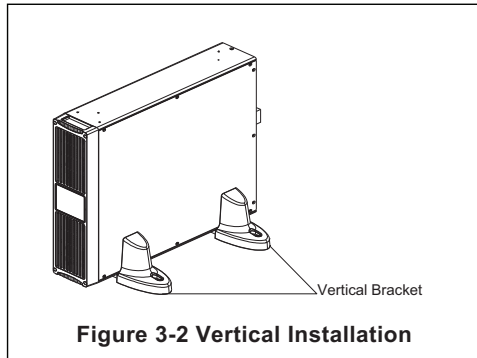

Figure 3-1 UPS Mounting



### **3-1-2 Vertical Installation**

- The UPS is rack mountable as well as standing alone. You can mount the UPS on the shelf, or you can erect the UPS with the supporting stands as Figure 3-2.



## **3-2 Connecting the battery bank**

1. Before installation, check the rating voltage of battery bank is suitable for the UPS.
2. When UPS is running for the first time, charge the UPS for at least 8 hours to ensure batteries inside are fully charged before operation.
3. Utilize the battery connection cable, be attached in battery bank package, packed with the battery bank and UPS show as Figure 3-3.

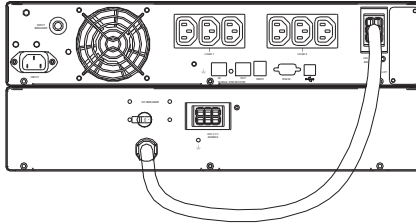

For 1KVA

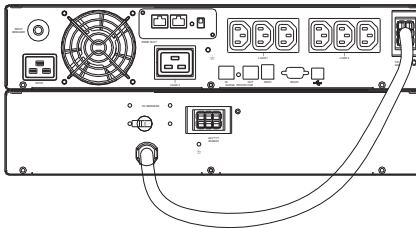

For 2KVA & 3KVA

**Figure 3-3 UPS Connected to the External Battery Bank**

**Notice:**

- ✓ Normally, the life of a battery is 3~5 years. But extreme operating condition and environment may shorten its life-span.
- ✓ When UPS has not been used for a period of time, the batteries will discharge slightly. It is recommended to charge the UPS once every 3 months.

**Safety Requirement:**

- ✓ In order to remove the battery power cord emergently, please plug in the power cord directly.
- ✓ Besides plugging in the battery power cord, the battery power cord needs to be fixed with the screws.

**3-3 Connecting the RS-232/Dry contact**

Connect the interface signal cable between the RS-232/Dry contact port on the rear panel of UPS and COM1 or COM2 of computer if necessary (Show as Figure 3-4.1 and 3-4.2). Refer to section four for more information.

**Figure 3-4.1 UPS Connection for 1KVA:**

1. Connect to RS232 Port.
2. Connect to PC.
3. AC input utility supplies power to the UPS.

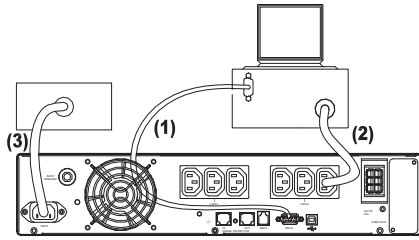

**Figure 3-4.2 UPS Connection for 2KVA or 3KVA:**

1. Connect to RS232 Port.
2. Connect to PC.
3. AC input utility supplies power to the UPS.

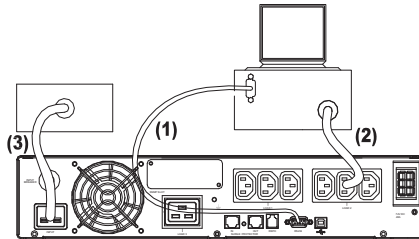

### **3-4 Connecting the load**

---

1. Calculate power consumption of your loads to ensure that the overload condition will not happen.
2. Plug the power cord of the equipment into the output receptacles on the rear panel of the UPS.

Caution: Do not connect a laser printer to the UPS.

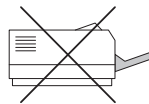

### 3-5 Connecting to utility power

AC input utility supplies power to the UPS. After that, the fan (in rear panel) will run and all LEDs will light for about 2-3 seconds. Users can check whether all LEDs are normal or not. The UPS is set in “STANDBY mode” initially. Meanwhile battery will be charged. (Shown as Figure 3-5)

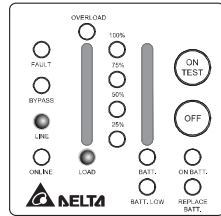

Figure 3-5 Stand-By Mode

### 3-6 Turning “ON” the UPS

When the utility power is acceptable for the UPS, line LED and load LED light on, you can normally turn on the UPS after pushing the [ On Test ] button and hold for 3 seconds until a short beep is heard. The bypass LED will extinguish after shortly light on. When the on-line LED lights on, the UPS is running in “ON-LINE mode”. (Shown as Figure 3-6) Note! When you hear the beep sound, please release the button.

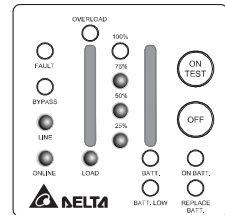

Figure 3-6 On-Line Mode

### 3-7 Cold start when utility power is not present

Even when there is no utility power, you can still turn on the UPS. Just press the [ On Test ] button and hold for 3 seconds, the UPS will start up after you hear a short beep. The battery LED and on-battery LED will light on and the UPS runs in “ON-BATTERY mode”. (Shown as Figure 3-7)

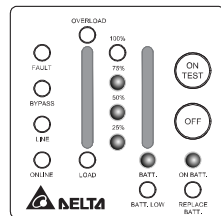

Figure 3-7 On Battery Mode

### 3-8 UPS self-test

If press the [ On Test ] button when the UPS is in “ON-LINE mode”, it will make the UPS shift to “ON-BATTERY mode” and automatically perform a self-test for about 10 seconds. The self-test function will check the condition of the battery. After self-test is finished and test is O.K, the UPS will return to “ON- LINE mode”.

### **3-9 Silence function**

The buzzer can be turned “On” or “Off” by pressing the [ On Test ] button when the UPS is in “ON-BATTERY mode”.

### **3-10 Turning “OFF” the UPS**

Push the [ OFF ] button for turning off the UPS. When a short beep is heard, please release your press. After a few seconds the UPS will be off.

The UPS will keep charging when UPS is in “STANDBY mode” even though the [ OFF ] button has been pressed. To fully turn off the UPS, it is advised to unplug the power cord.

### **3-11 If certain abnormal condition occurs, the UPS will send the following messages:**

“ON-BATTERY mode”: When the UPS is in “ON-BATTERY mode”, the on- battery LED will light on, buzzer beep half second every 2 seconds and then the UPS will start supplying power to load through batteries. (Shown as Figure 3-8)

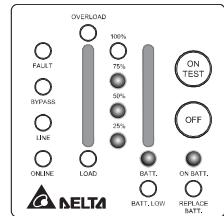

**Figure 3-8 On-Battery Mode**

**OVERLOAD:** If the load exceeds the UPS rating, after a limited period, the overload LED will light on and buzzer continuous beeping to alarm the user. The user should unplug some uncritical loads to release the overload condition. (Shown as Figure 3-9)

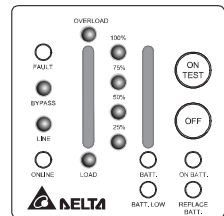

**Figure 3-9 Overload and UPS turn into Bypass**

**BATTERY REPLACE:** This LED function is to alert user that the batteries should be replaced. When the microprocessor in the UPS detects a battery fault, the buzzer beep 0.1 second every 2 seconds. (Shown as Figure 3-10)

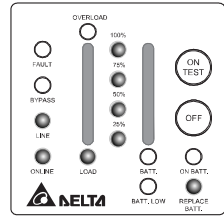

**Figure 3-10**  
**Battery Replace**

**BATTERY LOW:** This function is to inform user the remaining power capacity of the batteries. When batteries reach a low level condition, the UPS alarm will beep half second every 1.5 seconds until running out of battery capacity. (Shown as Figure 3-11)

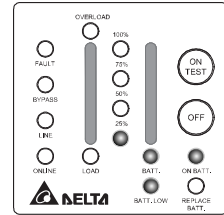

**Figure 3-11**  
**Battery Low**

**SHORT CIRCUIT:** When the output of the UPS shorts in “ON-LINE mode” or “ON-BATTERY mode”, the UPS will shut down (without output voltage). As soon as the short circuit is happened, the fault LED will light on and the UPS alarm will sound continuously. When remove short circuit, the UPS output will recover. If short circuit is happened in “BYPASS mode”, the UPS will protect itself by tripping the input breaker and shut down. (Shown as Figure 3-12)

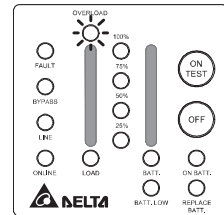

**Figure 3-12**  
**Short Circuit**

### **3-12 De-rating Power**

In the range of 130Vac to 160Vac, the UPS load capacity will decrease. This function provides a wider operating power voltage range.

### 3-13 UPS internal fault

If the following conditions occur, the UPS fails. At this time the UPS will transfer to “BYPASS mode”. The bypass LED and fault LED will light on and alarm continuously. If utility is too low or too high the UPS output will be disabled. For fault messages, please refer to the troubleshooting (section 6) of this manual.

- ✓ When the UPS inner components overheat, the UPS will protect itself by thermal switches. This status is so-called “O.T.P”. Show as Figure 3-13. When the UPS fan is failure. It is show as Figure 3-14.
- ✓ When under (or over) voltage is happened in the UPS output. This kind of fault will be detected by the microprocessor in the UPS and is so-called “U.V.P” (“O.V.P”). Show as Figure 3-15, 3-16.
- ✓ When under (or over) bus voltage is happened in the UPS and is so-called “Bus U.V.P” (“Bus O.V.P”). Show as Figure 3-17, 3-18.

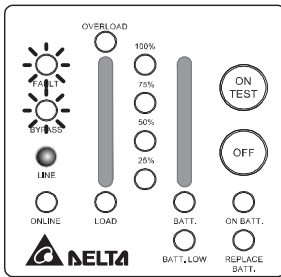

Figure 3-13 (O.T.P.)

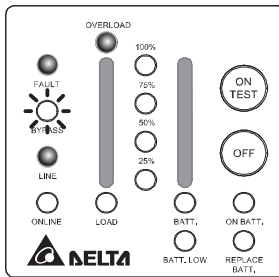

Figure 3-14 (Fan Fail)

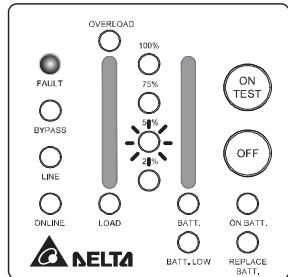

Figure 3-15 (Inverter U.V.P.)

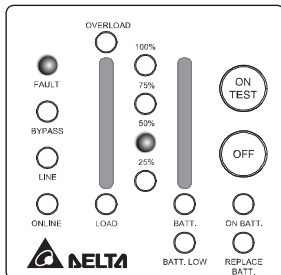

Figure 3-16  
(Inverter O.V.P.)

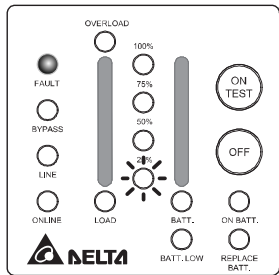

Figure 3-17  
(DC BUS U.V.P.)

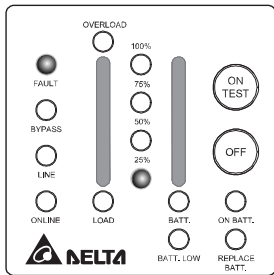
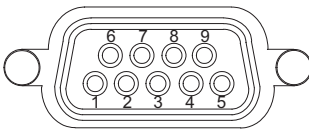

Figure 3-18  
(DC BUS O.V.P.)

## CHAPTER 4 COMMUNICATION INTERFACE

The UPS provides RS-232 and Dry contact protocols in one D-sub 9 connector. Using proper UPS management software and cable, the UPS can be managed in LAN/ Intranet/ Internet environment. The pin assignment of the D-sub 9 connector is defined as follows:

PIN	ASSIGNMENT DESCRIPTION	
	RS-232	Dry Contact
1		Low battery (Open collector)
2	UPS TxD (typical RS-232 level)	
3	UPS RxD (typical RS-232 level)	Remote Shutdown (5~12V)
4	Reserved for PNP	
5	GND	GND
6	Reserved for PNP	Reserved
7	Reserved for PNP	Reserved
8		Utility Fail (Open collector)
9		



**Figure 4-1 Pin Assignment**

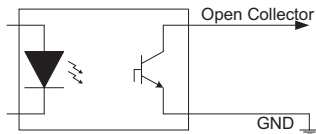

**Figure 4-2 Open Collector Circuit**

Maximum voltage and current on pin 1, 8 is 30VDC, 10mA.



## **4-1 RS232/ USB**

---

The **RS232/USB** communication port provides the following functions:

1. Monitoring charger status
2. Monitoring battery status and condition
3. Monitoring inverter status
4. Monitoring UPS status
5. Monitoring the utility power status
6. Providing the power switch function for computer to turn on/off the utility power on schedule for power saving
7. Adjustable Transfer voltage

### **HARDWARE:**

BAUD RATE----- 2400 bps  
DATA LENGTH----- 8 bits  
STOP BIT----- 1 bit  
PARITY----- NONE

### **CABLING:**

Standard D-sub 9 cable (UPS side: male, PC side: female)

## 4-2 Dry Contact

---

Its major functions normally some or all of following:

1. To broadcast a warning when power fails.
2. To close the files before the battery is exhausted.
3. To turn off the UPS via computers.

Pin1	The pin is normally open. When battery low, pin1 and pin5 are connected via photo coupler.
Pin3	On Battery mode, the UPS will shut down when a high level voltage (5~12V) sustained for at least 3.8 seconds is applied.
Pin5	Signal ground.
Pin6, 7	Reserved.
Pin8	The pin is normally open. When utility fails, pin8 and pin5 are connected via photo coupler.

### Cabling:

The users must use the special cable. The connection is described as follows:

PC (female) UPS (male)  
Pin1-----Pin1 (battery Low)  
Pin3-----Pin5 (GND)  
Pin4-----Pin3 (Shutdown)  
Pin7-----Pin6  
Pin7-----Pin7  
Pin8-----Pin8 (AC Fail)

The communication port on the rear panel of the UPS may be connected to a computer. This port allows the computer to monitor the UPS and control the operation of the UPS in some cases.

Some computers may have a special connector to link this communication port, or require a special plug-in card, or need special UPS monitoring software. Contact your dealer for details of different interface kits.

### Caution:

Every time when you connect your UPS and computer, please make sure the utility exists.

## 4-3 SNMP CARD

---

1. SNMP (Simple Network Management Protocol) is the most popular protocol in the network. Via NMS (Network Management Station) can detect the status of all facilities in the network.
2. On the rear panel of UPS built-in a SNMP slot (Please refer to Figure 2-2 ), this optional interface unit can integrate UPS into the network and then you can easily monitor the UPS status. Once you install SNMP card in the UPS, you can't get any information from UPS via RS232. i.e.
3. The SNMP card also supports SHTTP protocol, you can use browser Microsoft IE or Netscape Communicator to monitor or configure UPS. Besides, SNMP card supports Telnet and FTP for remote monitoring and firmware upgrading.

### Specification:

- Auto detecting 10/100M Network speed.
- Supporting protocol: TCP/IP, UDP, HTTP, ICMP, ARP, TELNET, BOOTP, DHCP, FTP and SNMPv1.
- Remote firmware upgradeable and configurable.
- Web server built-in, allow monitoring/controlling UPS via browser.
- VT100 terminal mode or Telnet to configure SNMP.

### Function:

- Schedule: Shutdown/Restart UPS, testing and control outlets.
- Testing: Scheduled testing battery can insure the UPS can work normally during power failure.
- Event log: Auto-record the power event.
- Historical records: Keep records of UPS status in specified interval.
- Event handling: configure special action for each power event to meet your requirement.
- On/ Off UPS: setup the power on/off timer.
- Outlet control: configure UPS outlets.

## CHAPTER 5 BATTERY REPLACEMENT

Servicing of batteries should be performed or supervised by personnel knowledgeable of batteries and the required precautions. Keep unauthorized personnel away from batteries.

### **5-1 Battery Replacement (See Figure 5-1)**

- ① Remove front panel.
- ② Unscrew four bolts of the battery compartment.
- ③ Unplug battery connectors.
- ④ Unscrew two bolts .
- ⑤ Pull the battery set out and renew it.
- ⑥ Assemble UPS by reverse procedure.

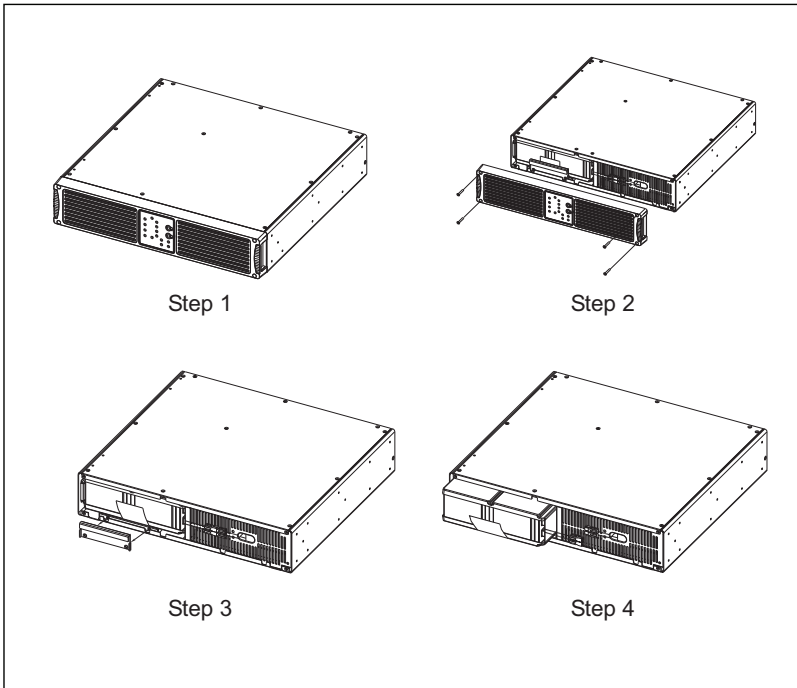

**Figure 5-1 Battery Replacement**

## CHAPTER 6 TROUBLESHOOTING

Problem	Possible Cause	Solution
UPS is not turned on. (No alarm, No LED lights)	ON/ TEST button is not pushed.	Press the ON/ TEST button to turn on the UPS. (Refer section 3 to turn on the UPS.)
	Battery low shutdown and utility is absent.	Waiting for line recovery.
	The rear panel input circuit breaker is tripped. (Button is tripped out)	1. Reduce some loads connected to the UPS. 2. Reset the circuit breaker. (Push button in)
	UPS fault.	Call for qualified service personnel if above actions do not solve the problem.
UPS does not provide expected back-up time.	Batteries inside the UPS are not fully charged.	Recharge the batteries for at least 8 hours.
	UPS is overloaded.	Remove some unnecessary loads.
	Batteries are weak.	Batteries weak faster when used often or operating at higher temperature. If the battery is near the end of its life, call for service personnel. Replace the battery even if the Replace Battery LED does not light.
	Charger fault or other reason.	Call for service.
"REPLACE BATTERY" LED lights on.	Weak batteries.	1. Recharge the batteries for at least 8 hours. 2. If problem remains Call for service personnel to, replace the batteries.

Problem	Possible Cause	Solution
PC-UPS communication does not work properly.	Incorrect transmission speed.	Re-test after using another different transmission speed.
	Incorrect RS-232 connection.	Refer to communication interface (Section 3-4) of this manual Re-connect the UPS with COM1 / COM2 on PC again.
	Incorrect USB connection.	Re-connect the UPS with USB on PC again.
UPS operates on battery even though the line is in normal operating condition.	No incoming utility.	Check input power connection.
	The rear panel input circuit breaker is tripped. (Button is out).	1. Reduce some loads connected to the UPS. 2. Reset the circuit breaker. (Push button in)
	Very high, low or distorted utility voltage.	Have qualified electrician check the input voltage.
UPS over temperature.	The exhaust fans and ventilation grills may be obstructed.	Choose a well-ventilated area to position your UPS to allow adequate dissipation of heat.
	The environment temperature exceeds 40°C (104°F).	Position your UPS in cooler area.
“FAULT”LED lights on, alarm beeps	UPS failure.	Call fore service engineer.
“OVERLOAD” LED lights on and buzzer beeps continuously.	Overloaded.	Remove some uncritical load.
UPS O.T.P. Warning	The components used inside the UPS overheat or wind channel block.	On-Line mode: Remove the utility.
		Backup mode: Press the OFF key to turn off the UPS.

**FAULT MESSAGE**

Following information indicates various symptoms.

Use this information to determine what factors cause the problem.

1. Alarm will sound to alert user that the UPS requires attention.
2. One or more additional load/battery level LED indicators will illuminate to provide a diagnostic aid to the operator, described as below (Show as Figure. 6-1):

Output temperature protect	Fault LED light flash
Output over voltage protect	50% LED light on
Output under voltage protect	50% LED light flash
Bus over voltage protect	25% LED light on
Bus under voltage protect	25% LED light flash

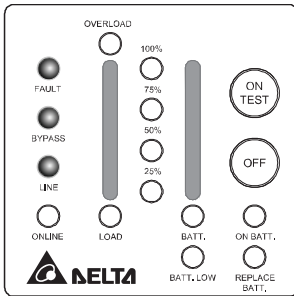

**Figure 6-1 (Fault)**

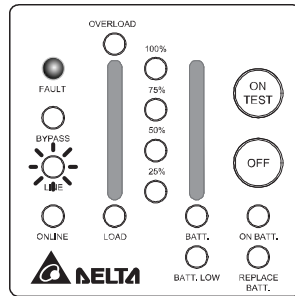

**Figure 6-2 (Fault)**

In case that failure is happened and utility is too low or too high, the UPS output will disable and the bypass and line LED will flash. Show as Figure. 6-2

If problem continues, contact your local dealer.

# TECHNICAL SPECIFICATIONS

Model		1KVA	2KVA	3KVA
<b>Capacity</b>		1KVA/800W	2KVA/1600W	3KVA/2100W
<b>INPUT</b>	Rated Voltage	200V, 208V, 220V, 230V, 240V		
	Voltage Range	160V~275V (Full Load) : 130V~160V (70% to 100% Load Linearly De-rating)		
	Frequency	50Hz/60Hz (±5 Hz)		
	Power Factor	≥0.97		
<b>Output</b>	Voltage	200V, 208V, 220V, 230V (default), 240V		
	Frequency	50 (default)/60Hz		
	Voltage Regulation	±2%		
	Frequency Accuracy	±0.05 Hz		
	Wave Form	Pure Sine Wave		
	Transient Response	±10% (10%~90% Linear Load)		
	THD	≤3%(Linear Load); ≤6%(Computer Load)		
	Overload Capacity	105%-125% for 3mins; 125%-150% for 30secs; >150% for 0.5sec		
	Crest Factor	3:1		
Efficiency (AC-AC)	≥ 87%			
<b>Outlet</b>	Receptacle	IEC320 C13×3×2	IEC320 C13×3×2 + IEC320 C19×1	IEC320 C13×3×2 + IEC320 C19×1
			48V	72V
<b>Battery</b>	Battery Voltage	24 V		
	Battery Type (Lead acid)	12V/ 8.5Ah		
	Back-up Time (Typical)	3.5mins (800W)	4mins (1600W)	5mins (2100W)
	Recharge Time	6 Hours After Complete Discharge to Recover 80%		
<b>Transfer Time</b>	Transfer Time	Zero		
<b>LED</b>	LED Status	On-line · Bypass · On-battery · Overload · Battery Low · Fault · Battery Replace · Battery Level · Load Level		
	Alarm	Buzzer		
<b>Interface</b>	DB9	RS232/Dry Contact		
	SNMP Slot	Internal		
	USB	USB Port		
<b>Environment</b>	Noise (At 1 Meter)	45dBA	50dBA	60dBA
	Operating Temperature	0~40°C		
	Humidity	5%~95% (Non-Condensing)		
<b>Safety Approval</b>	Safety	CE		
	EMC	EN62040-2	EN62040-2	
	Lightning	IEEE 62.41 Category A		
<b>Others</b>	Battery Start	Yes		
	Extended Battery Bank	Yes (Optional with Long Time)		
	Long Time Model	Yes (Optional)		
<b>Appearance</b>	Dimension (W×D×H)	440x335x89 /mm 17.3x13.2x3.5 / inch	440x432x89 /mm 17.3x17x3.5 /inch	440x610x89 /mm 17.3x24x3.5 /inch
	Weight	13.0 kg / 28.7 lb	21.0 kg / 46.3 lb	31.0 kg / 68.3 lb

 All specifications are subject to change without prior notice.



## Warranty

Seller warrants this product, if used in accordance with all applicable instructions, to be free from original defects in material and workmanship within the warranty period. If the product has any failure problem within the warranty period, Seller will repair or replace the product at its sole discretion according to the failure situation.

This warranty does not apply to normal wear or to damage resulting from improper installation, operation, usage, maintenance or irresistible force (i.e. war, fire, natural disaster, etc.), and this warranty also expressly excludes all incidental and consequential damages.

Maintenance service for a fee is provided for any damage out of the warranty period. If any maintenance is required, please directly contact the supplier or Seller.

**WARNING :** The individual user should take care to determine prior to use whether the environment and the load characteristic are suitable, adequate or safe for the installation and the usage of this product. The User Manual must be carefully followed. Seller makes no representation or warranty as to the suitability or fitness of this product for any specific application.





