

The power behind competitiveness

Delta UPS - Amplon Family

RT Series, Single Phase
1/ 2/ 3 kVA

User Manual

www.deltapowersolutions.com



DELTA
Smarter. Greener. Together.

Save This Manual

This manual contains important instructions and warnings that you should follow during the installation, operation, storage and maintenance of this product. Failure to heed these instructions and warnings will void the warranty.

Copyright © 2015 by Delta Electronics Inc. All Rights Reserved. All rights of this User Manual (“Manual”), including but not limited to the contents, information, and figures are solely owned and reserved by Delta Electronics Inc. (“Delta”). The Manual can only be applied to the operation or the use of this product. Any disposition, duplication, dissemination, reproduction, modification, translation, extraction, or usage of this Manual in whole or in part is prohibited without the prior written permission of Delta. Given that Delta will continuously improve and develop the product, changes may be made to the information in this Manual at any time without obligation to notify any person of such revision or changes. Delta will make all possible efforts to secure the accuracy and the integrity of this Manual. Delta disclaims any kinds or forms of warranty, guarantee, or undertaking, either expressly or implicitly, including but not limited to the completeness, faultlessness, accuracy, non-infringement, merchantability or fitness for a particular purpose of the Manual.

Table of Contents

Chapter 1 : Important Safety Instructions	1
1.1 Safety Instructions	1
1.2 Standard Compliance	7
1.3 Storage	7
Chapter 2 : Introduction	8
2.1 General Overview	8
2.2 Package Inspection	8
2.3 Functions & Features	12
2.4 Exterior & Dimensions	13
2.5 Operation Panel	14
2.5.1 LED Indicators	15
2.5.2 Multi-function Buttons	15
2.5.3 LCD Display	17
2.5.4 7-Segment Display	21
2.5.5 Flow Chart of the 7-Segment Display	23
2.6 Rear Panel	25
Chapter 3 : Installation	31
3.1 Installation Data	31
3.2 Rack Mounting Procedures for the UPS and the Delta External Battery Pack (Optional)	32
3.3 Tower Mounting Procedures for the UPS and the Delta External Battery Pack (Optional)	34
Chapter 4 : Connections	37
4.1 Pre-connection warnings	37
4.2 Delta External Battery Pack (Optional) Connection	37
4.3 Communication Interface Connection	39
4.4 Critical Load Connection	39
4.5 Utility Power Connection	40
Chapter 5 : Operation Modes	41

5.1	Standby Mode-----	41
5.2	On-line Mode -----	41
5.3	Bypass Mode-----	41
5.4	Battery Mode -----	41
5.5	ECO Mode -----	42
5.6	Frequency Converter Mode-----	42
5.7	Setup Mode-----	42
Chapter 6 : Operation -----		45
6.1	Start-up Procedures -----	45
6.2	Shutdown Procedures-----	45
6.3	Cold Start-----	45
6.4	Silence Function-----	45
6.5	Battery Test -----	46
6.6	Alarm -----	46
6.7	De-rating Power -----	47
6.8	Online Mode/ Battery Mode Overload Cut-off -----	47
6.9	Input Breaker -----	47
6.10	Generator Compatible-----	48
Chapter 7 : Communication Interfaces -----		49
Chapter 8 : Internal Battery Replacement -----		52
Chapter 9 : Optional Accessories -----		56
Chapter 10 : Maintenance-----		57
10.1	UPS-----	57
10.2	Batteries -----	57
10.3	Fan-----	58
Chapter 11 : Troubleshooting-----		59
Appendix 1 : Technical Specifications-----		62
Appendix 2 : Warranty -----		65

Chapter 1 : Important Safety Instructions

1.1 Safety Instructions

- **Intended Use**

1. The unit serves as a single-phase on-line uninterruptible power supply (UPS) for its connected loads.
2. Do not connect laser printers or scanners to the UPS. This may cause damage to the unit.
3. The UPS is available in 1kVA, 2 kVA and 3 kVA. Each kVA model has internal batteries and each model can connect the Delta external battery pack (optional). The nominal rating voltage of internal batteries is 24V, 48V and 72V for 1kVA, 2 kVA and 3 kVA respectively.
4. The UPS can be used to power computers and associated peripheral devices, such as monitors, modems, cartridge tape drives, external hard drives, etc.

- **Handling**

Transport the unit only in suitable packaging to protect it from jolts and shocks. The UPS must be kept upright at all times and handled with care.

- **Placement & Installation Warnings**

1. Install the UPS in a well-ventilated area, away from extreme temperatures, excess moisture, heat, dust, flammable gas or explosives.
2. Leave adequate space at least 15cm in front and at rear of the UPS for proper ventilation.
3. Electrical maintenance and service requires access to the front and back of the UPS. Leave necessary space to allow service personnel access to the UPS.
4. The UPS can be installed vertically (tower-mounting) or horizontally (rack-mounting) according to the user's desired arrangement. Please obey the following:
 - * Do not mount the UPS with its front or rear panel facing down at any angle.

- * Keep the UPS upright at all times and handle it with care.
 - * Do not stack the units.
 - * Do not place any objects on the UPS, the Delta external battery pack (optional) or any other accessory associated with the UPS.
 - * Install the UPS and the Delta external battery pack (optional) on a level and even surface.
 - * For tower-mounting installation, ensure that your chosen location's floor can bear the weight of the UPS, the Delta external battery pack (optional) and tower stands (optional).
 - * For rack-mounting installation, make sure your chosen cabinet can support the weight of the UPS, the Delta external battery pack (optional) and the rails that may be mounted in an associated rack. You also need to take your chosen location's floor weight loading into consideration.
 - * For rack-mounting installation, do not let your rack become 'top heavy'. Install the heaviest equipment near the bottom of the rack.
 - * For weight information about the UPS and the Delta external battery pack (optional), please refer to **Appendix 1 : Technical Specifications**.
 - * Install the UPS in accordance with the conditions specified in **3.1 Installation Data**.
5. To reduce the risk of electric shock, install the UPS in a temperature and humidity controlled indoor area free of conductive contaminants.
 6. The operating temperature is at 0°C~40°C.
- **General Warnings**
 1. Electrical shock hazard: even when the UPS is disconnected from the mains, hazardous voltage may still exist at the output receptacles of the UPS. Before maintenance, cut off the AC source and disconnect the UPS and the external battery pack. After that, follow **Chapter 8 : Internal Battery Replacement** to remove the internal batteries. Only after the above procedures are completed, the further maintenance action can be executed.
 2. Even when all switches and/ or circuit breakers are open, dangerous voltage is present within the unit.
 3. Forbid opening or removing the cover of the UPS to avoid high voltage electric shock. There are no user-serviceable parts inside.

4. Maintenance service must be performed by qualified service personnel. Only qualified personnel can carry out any operation that requires protection panels to be opened and/or removed.
5. Any repairs or modifications by the user may result in out-of-warranty repair charges or unsafe electrical conditions.
6. Do not use extension cords to connect the UPS to an AC outlet.
7. Do not plug the UPS's input cord into its own output receptacles.

• Usage Warnings

1. Before usage, you must unpack the UPS and allow it to adjust to room temperature (20°C~25°C) for at least two hours to avoid moisture condensing inside the UPS.
2. The external slits and openings in the UPS are provided for ventilation. To ensure reliable operation of the UPS and to protect the UPS from overheating, these slits and openings must not be blocked or covered. Do not insert any object into the slits and openings that may hinder ventilation.
3. Even though all buttons are in the OFF position, the UPS is not isolated from the mains. To completely isolate the UPS from the mains, please disconnect the input power cord.
4. The unit supplies power from two sources, the mains and the batteries. The output receptacles may have voltage present even when the unit is unplugged. Unplugging the UPS puts it into battery mode and the batteries supply power to the connected loads.
5. Route all cords well so that nobody can stand on them or trip over them.
6. When connecting the unit to the power supply, follow the instructions stated in **Chapter 4 : Connections**.
7. Ensure that no objects (e.g. rings, necklaces, paper clips, etc.) get inside the unit.
8. In an emergency, switch off the unit, disconnect it from the mains and contact the responsible customer service representative.
9. Do not connect any equipment that requires DC current.
10. Do not connect any equipment that may overload the UPS.
11. Do not connect or disconnect any cables during a thunderstorm.

12. The sum of current leakage from the UPS and its connected loads must not exceed 3.5 mA.
13. The UPS has a REPO (remote emergency power off) port located at the rear. Please see **Chapter 7 : Communication Interfaces** for more information.
14. The UPS must be well grounded due to a possible risk of current leakage. The unit is equipped with a safety-inspected mains line and must be connected to an earthing-contact wall socket. If the wall socket does not have an earthing connection, please ground the UPS via the ground terminal located at the rear of the UPS. Please see **2.6 Rear Panel**.
15. Ensure that the sockets on the unit or the earthing-contact wall socket are freely accessible.

- **Battery Precautions**

1. Do not open or mutilate the battery or batteries. The released electrolyte is harmful to the skin and eyes and may be toxic. If the electrolyte splashes into your eyes or onto your skin, immediately flush them out with water and seek immediate medical advice.
2. Do not dispose of the battery or batteries in a fire. The batteries may explode.
3. The risk of dangerous voltage is possible when the batteries are still connected to the UPS even though the UPS is disconnected from the mains. Do not forget to disconnect the battery cable to completely cut off the battery source.
4. Voltage is always present on the battery terminals.
5. The UPS contains batteries, which are potentially hazardous to the user, even when the UPS is not connected to the utility power.
6. Even when discharged, a battery has the capacity to supply a high short circuit current, which, in addition to causing damage to the battery itself and to associated cables, may expose the operator to the risk of burns.
7. To ensure battery performance, idle batteries must be fully recharged every three months if the UPS needs to be stored for an extended period of time. Whenever you recharge the batteries (internal and external), please fully charge them until the Battery Level Bar Graph  shown on the UPS's LCD is fully on.

8. Since new batteries often do not provide full capacity after an initial charge, it may be necessary to carry out a number of discharge/ recharge cycles before optimum performance is achieved.
9. Servicing of batteries and battery packs should be performed or supervised by qualified service personnel knowledgeable in batteries, battery packs and the required precautions.
10. Only use the same type of batteries from the same supplier. Never use old, new and different Ah batteries at the same time. The types of batteries are HRC9-12 (BB), HR9-12 (BB), HR1234WF2 (CSB), CP1290 (Center Power), HPS12-36W (Center Power), HRC1234W (BB), LP12-9.0 (Leoch) and SSP12-9 (SACRED SUN).
11. A battery can present a risk of electrical shock and high short-circuit current. The following precautions should be observed when working on batteries:
 - * Remove watches, rings, or other metal objects.
 - * Use tools with insulated handles.
 - * Wear rubber gloves and boots.
 - * Do not lay tools or metal parts on top of batteries.
 - * Disconnect the charging source prior to connecting or disconnecting battery terminals.

● Disposal

1. To protect our environment, the UPS and batteries must be disposed of in accordance with local laws and regulations.
2. For proper disposal of the UPS and batteries, contact your local recycling/ reuse or hazardous waste center.



WARNING:

You must contact qualified service personnel if either of the following events occur:

1. Liquid is poured or splashed on the UPS or the Delta external battery pack (optional).
2. The UPS does not run normally after this User Manual is carefully observed.

- **Federal Communications Commission Interference Statement**

[1KVA Model]

This equipment has been tested and found to comply with the limits for a Class B digital device, pursuant to Part 15 of the FCC Rules. These limits are designed to provide reasonable protection against harmful interference in a residential installation. This equipment generates, uses and can radiate radio frequency energy and, if not installed and used in accordance with the instructions, may cause harmful interference to radio communications. However, there is no guarantee that interference will not occur in a particular installation. If this equipment does cause harmful interference to radio or television reception, which can be determined by turning the equipment off and on, the user is encouraged to try to correct the interference by one of the following measures:

- * Reorient or relocate the receiving antenna.
- * Increase the separation between the equipment and receiver.
- * Connect the equipment into an outlet on a circuit different from that to which the receiver is connected.
- * Consult the dealer or an experienced radio/TV technician for help.

FCC Caution

To assure continued compliance, use only shielded interface cables when connecting to computer or peripheral devices. Any changes or modifications not expressly approved by the party responsible for compliance could void the user's authority to operate this equipment.

This device complies with Part 15 of the FCC Rules. Operation is subject to the following two conditions:

(1) this device may not cause harmful interference, and (2) this device must accept any interference received, including interference that may cause undesired operation.

[2 kVA / 3kVA Models]

This equipment has been tested and found to comply with the limits for a Class A digital device, pursuant to Part 15 of the FCC Rules. These limits are designed to provide reasonable protection against harmful interference when the equipment is operated in a commercial environment. This equipment generates, uses and can radiate radio frequency energy and, if not installed and used in accordance with the instructions manual, may cause harmful interference to

radio communications. Operation of this equipment in a residential area is likely to cause harmful interference in which case the user will be required to correct the interference at his/ her own expense.

1.2 Standard Compliance



- CE
- RCM
- KC
- CB Report (by TUV)
- EN 62040-1
- EMC EN62040-2 C1

1.3 Storage

- **Prior to installation**

If the UPS needs to be stored prior to installation, it should be placed in a dry area. The allowable storage temperature and relative humidity (non-condensing) are -15°C ~ $+50^{\circ}\text{C}$ and 5~95% respectively.

- **After usage**

Press the  button, disconnect the UPS from the utility power, make sure the UPS is shut down, remove all equipment from the UPS, and store the UPS in a dry and well-ventilated area at a temperature between -15°C and $+50^{\circ}\text{C}$ and at a relative humidity (non-condensing) between 5~95%. Idle batteries must be fully recharged every three months if the UPS needs to be stored for an extended period of time. Whenever you recharge the batteries (internal and external), please fully charge them until the Battery Level Bar Graph  shown on the UPS's LCD is fully on.



NOTE: After storage and before start-up of the UPS, you must allow the UPS to adjust to room temperature (20°C ~ 25°C) for at least two hours to avoid moisture condensing inside the UPS.

Chapter 2 : Introduction

2.1 General Overview

The RT series UPS, available in 1kVA, 2 kVA and 3 kVA, is an advanced on-line and double-conversion UPS providing reliable and consistent sine-wave quality power to your equipment. It supports personal computers, networks, servers, telecommunication equipment and a variety of other facilities.

Each model has internal batteries and can connect to the Delta external battery pack (optional). The unit provides output power factor up to 0.9, produces greater electric power efficiency at less cost, and keeps your applications safe and running smoothly at all times.

2.2 Package Inspection

- **External**

During UPS transportation, some unpredictable situations might occur. It is recommended that you inspect the UPS's exterior packaging. If you notice any damage, please immediately contact the dealer from whom you purchased the unit.

- **Internal**

1. Check the rating label on the UPS and make sure the device No. and capacity match what you ordered.
2. Examine if any parts are loose or damaged.
3. The UPS package contains the following items. Please check if any items are missing.

* For Models:

1 kVA : UPS102R2RT0B035/ UPS102R2RT0B1B1/ UPS102R2RT0B0B6

2 kVA : UPS202R2RT0B035/ UPS202R2RT0B1B1/ UPS202R2RT0B0B6

3 kVA : UPS302R2RT0B035/ UPS302R2RT0B1B1/ UPS302R2RT0B0B6

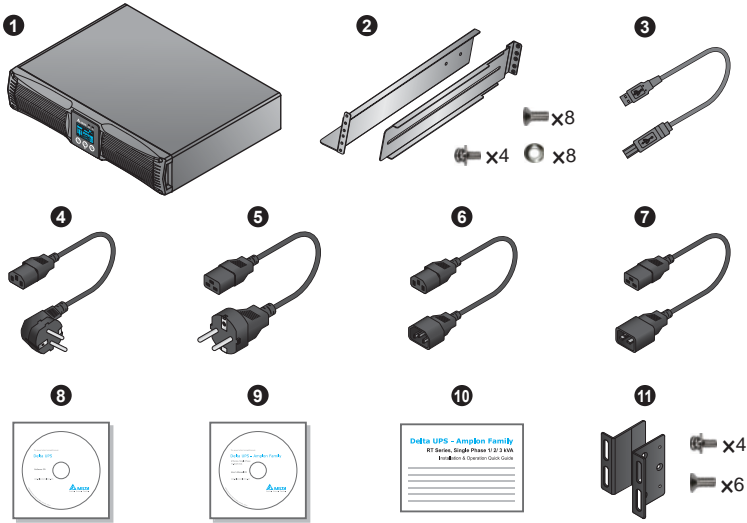

No.	Item	Q'ty	1 kVA	2/ 3 kVA
1	UPS	1 PC	✓	✓
2	Rail Kit	1 Set	✓	✓
3	USB Cable	1 PC	✓	✓
4	Input Cable 10A	1 PC	✓	✗
5	Input Cable 16A	1 PC	✗	✓
6	Output Cable 10A	1 PC	✓	✓
7	Output Cable 16A	1 PC	✗	✓
8	Software CD-UPSentry 2012	1 PC	✓	✓
9	User's Manual CD	1 PC	✓	✓
10	Quick Guide	1 PC	✓	✓
11	Bracket Ear	1 Set	✓	✓

* For Models:

1 kVA : UPS102R2RT0B0B1

2 kVA : UPS202R2RT0B0B1

3 kVA : UPS302R2RT0B0B1

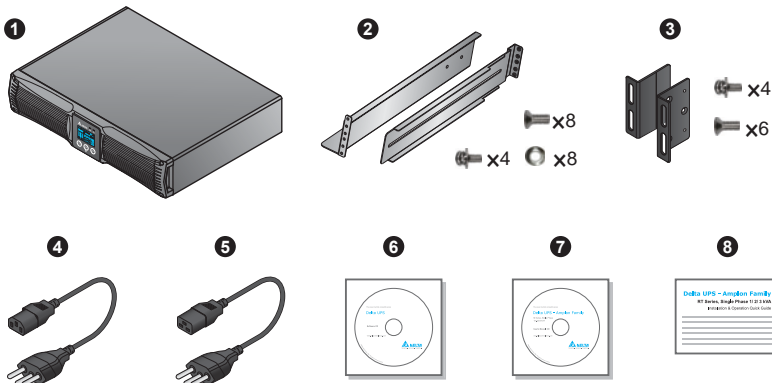

No.	Item	Q'ty	1 kVA	2/ 3 kVA
①	UPS	1 PC	✓	✓
②	Rail Kit	1 Set	✓	✓
③	Bracket Ear	1 Set	✓	✓
④	Input Cable 10A	1 PC	✓	✗
⑤	Input Cable 16A	1 PC	✗	✓
⑥	Software CD-UPSentry 2012	1 PC	✓	✓
⑦	User's Manual CD	1 PC	✓	✓
⑧	Quick Guide	1 PC	✓	✓

* For Models:

1 kVA : UPS102R2RT0B0B2

2 kVA : UPS202R2RT0B0B2

3 kVA : UPS302R2RT0B0B2

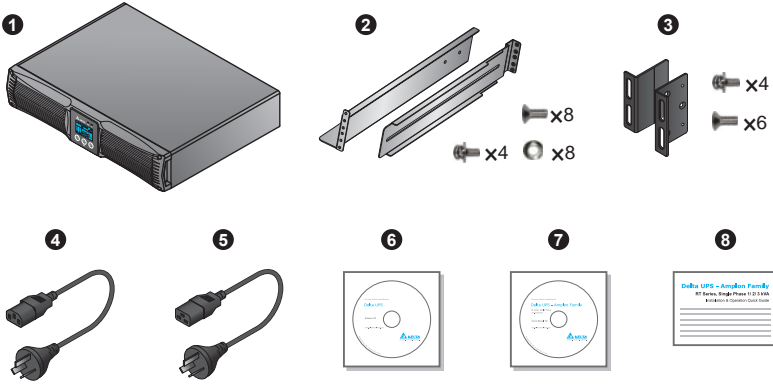

No.	Item	Q'ty	1 kVA	2/ 3 kVA
①	UPS	1 PC	✓	✓
②	Rail Kit	1 Set	✓	✓
③	Bracket Ear	1 Set	✓	✓
④	Input Cable 10A	1 PC	✓	✗
⑤	Input Cable 16A	1 PC	✗	✓
⑥	Software CD-UPSentry 2012	1 PC	✓	✓
⑦	User's Manual CD	1 PC	✓	✓
⑧	Quick Guide	1 PC	✓	✓

4. If there is any damage or anything missing, please immediately contact the dealer from whom you purchased the unit.
5. If the UPS needs to be returned, carefully repack the UPS and all of the accessories using the original packing material that came with the unit.

2.3 Functions & Features

- User-friendly LCD and LED indicators
- Output power factor up to 0.9
- Cold start
- REPO function
- Input circuit breaker protection
- Generator compatible
- Hot swappable internal batteries
- Hot swappable Delta external battery pack (optional)
- Battery deep discharging protection
- Intelligent monitoring software connectivity through RS-232 port or USB port
- Provides the following functions via configuration of UPSentry 2012 software (included in the provided CD), SNMP card (optional) or ModBus card (optional):
 - * Regular self-test
 - * History logs for records and analysis
 - * Remain time & lock time estimate
 - * Real-time power condition monitoring
 - * System shutdown control
 - * UPS schedule ON/Off, 10-sec, deep discharging test
- On-Line/ Double-Conversion
- 2% output voltage regulation (for linear load in on-line mode)
- High efficiency_92% in on-line mode and 96% in ECO mode (for 2kVA and 3 kVA models only)
- Zero transfer time in on-line mode.
- Sinusoidal waveform output
- Surge/ overload protection
- Network management
- Rack/ tower installation

2.4 Exterior & Dimensions

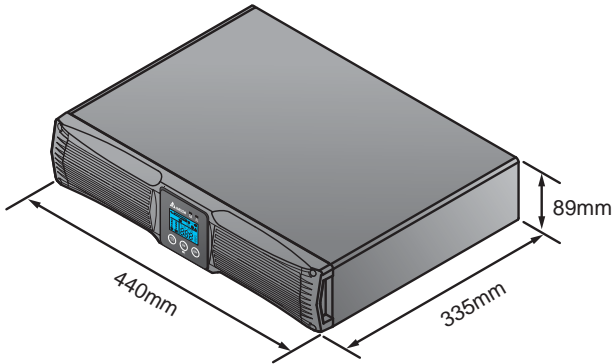

(Figure 2-1 : 1 kVA Exterior & Dimensions)

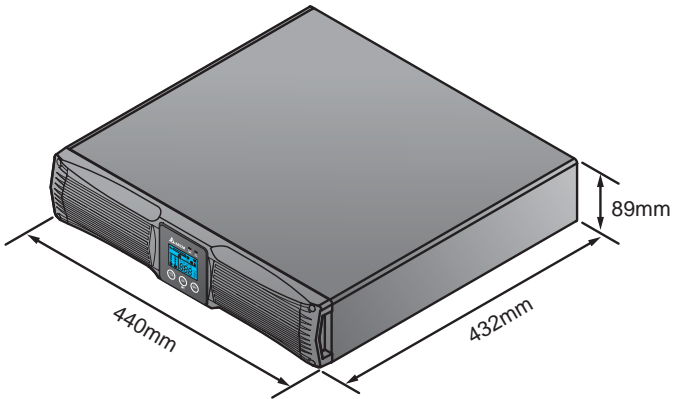

(Figure 2-2 : 2 kVA Exterior & Dimensions)

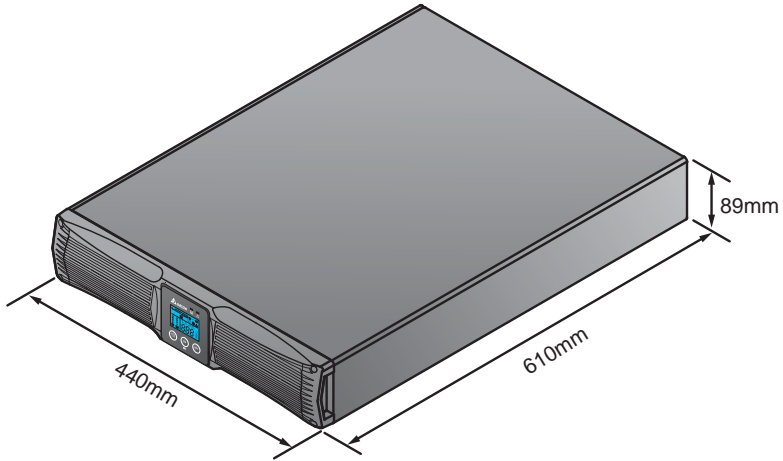



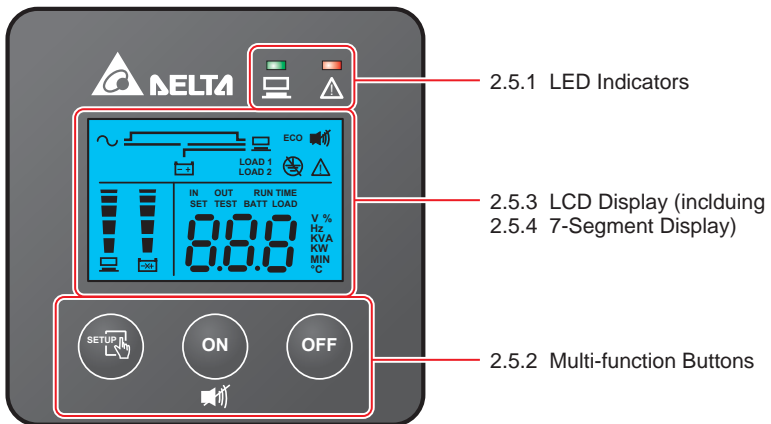

(Figure 2-3 : 3 kVA Exterior & Dimensions)

2.5 Operation Panel











2.5.1 LED Indicators

No.	LED	Description
1		<p>Indicates the output status.</p> <ol style="list-style-type: none"> ON (green): There is output OFF: There is no output
2		<ol style="list-style-type: none"> ON (red): The UPS detects an internal fault or an environmental fault. You could refer to 2.5 Operation Panel - 2.5.3 LCD Display - No.13 for more information. Flashing (red): The UPS has the following warning message(s). <ol style="list-style-type: none"> : There is no battery or battery replacement is needed. : The UPS is overloaded.

2.5.2 Multi-function Buttons

No.	Multi-function Button	Description
1		<p>The button has multi-function. Please refer to the following for detailed information.</p> <ol style="list-style-type: none"> Turn-on: <ul style="list-style-type: none"> In standby mode, press and hold the button for 3 seconds, release it after you hear one beep and the UPS will run in on-line mode. Cold start: When there is no AC input, press and hold the button for 3 seconds, release it after you hear one beep and the UPS will start up in battery mode. Battery Test: <p>Battery test can only be executed in on-line mode and in ECO mode.</p> <ul style="list-style-type: none"> For automatic regular battery test, you must install the UPSentry 2012 software (included in the provided CD), or configure the SNMP card (optional) or ModBus card (optional).

No.	Multi-function Button	Description
1		<ul style="list-style-type: none"> For manual battery test, please press and hold the button for 3 seconds, release it after you hear one beep, and the UPS will transfer to run in battery mode and perform a 10-sec battery test. <p>If the test result is ok, the LCD will show 'PAS' and the UPS will return to on-line mode or ECO mode (according to its original operation mode).</p> <p>If the test result is abnormal, the LCD will show 'FAL', the LED   will flash, the warning icon  and no-battery/battery replacement icon  will illuminate, and the UPS will return to on-line mode or ECO mode (according to its original operation mode).</p> <p>3. Buzzer Off: When the buzzer is on, press the button for 0.1 second to turn the buzzer off. Please note that the buzzer will automatically turn on when a new alarm occurs.</p> <p>4. Confirmation: In setup mode, press the button for 0.1 second to confirm your parameter setup.</p>
2		<p>The button has multi-function. Please refer to the following for detailed information.</p> <p>1. Turn-off:</p> <ul style="list-style-type: none"> In on-line mode, press and hold the button for 3 seconds, release it after you hear one beep and the inverter will be off and the UPS will transfer to run in standby mode. <p>The UPS will keep charging the batteries when the UPS is in standby mode even though the button has been pressed. To fully turn off the UPS, it is advised to unplug the input power cord.</p> <ul style="list-style-type: none"> In battery mode, press and hold the button for 3 seconds, release it after you hear one beep and the UPS will turn off its output.

No.	Multi-function Button	Description
2		<p>2. Fault Clear:</p> <p>When the UPS has a fault condition, press and hold the button for 3 seconds, release it after you hear one beep and the UPS will clear the fault condition and return to standby mode. Besides, the LCD will show the relevant error code. For error code information, please refer to 2.5 Operation Panel - 2.5.3 LCD Display - No.13.</p>
3		<p>The button has multi-function. Please refer to the following for detailed information.</p> <p>1. Scrolling down:</p> <p>Press the button for 0.1 second to go to the next display.</p> <p>2. Entering into the setup mode:</p> <p>Press the button for 3 seconds and the UPS will enter into the setup mode. For more information, please refer to 5.7 Setup Mode. Please note that only qualified service personnel can perform setup action.</p>









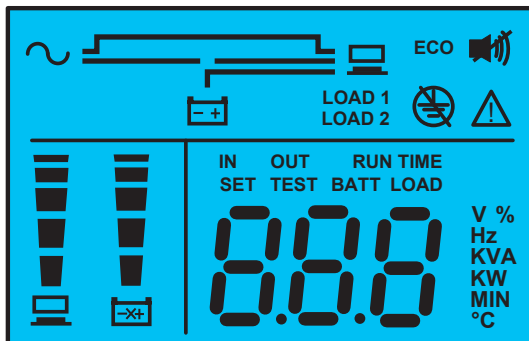





NOTE:





When the backlight of the LCD is off, you can press any button mentioned above to wake up the display and enable each button function.

2.5.3 LCD Display



No.	Icon	Naming	Description
1		AC Icon	Indicates the input source status. 1. ON: The AC input is within the acceptable bypass range. 2. Flashing: The AC input is out of the acceptable bypass range but is still sufficient to let the unit operate in on-line mode. 3. OFF: The AC input is out of the acceptable bypass range and is not sufficient to let the unit operate in on-line mode.
2		Load bank Icon	Indicates the output status. 1. ON (green): There is output to the load bank 1/ load bank 2. 2. OFF: There is no output to the load bank 1/ load bank 2.
3		Battery Power Icon	Indicates the battery power status. 1. ON: Battery power is on. 2. OFF: Output is not supplied by the battery power.
4		Standby Mode Graph	Illuminates when the UPS is operating in standby mode.
5		Online Mode Graph	Illuminates when the UPS is operating in on-line mode.
6		Frequency Converter Mode Graph	Flashes when the UPS is operating in frequency converter mode.
7		Battery Mode Graph	Illuminates when the UPS is operating in battery mode.
8		Bypass Mode Graph	Illuminates when the UPS is operating in bypass mode.
9		ECO Mode Graph	Illuminates when the UPS is operating in ECO mode.

No.	Icon	Naming	Description																												
10	ECO	ECO Icon	<p>Illuminates when the UPS is in ECO mode.</p> <ol style="list-style-type: none"> 1. ON: ECO function is enabled and the connected loads are feed by the utility AC power. 2. Flashing: ECO function is enabled and the connected loads are feed by the double conversion. 																												
11		Site Wiring Fault Icon	Reserved. This function is only applicable to 120Vac model.																												
12		Buzzer Icon	Illuminates when the buzzer is disabled.																												
13		Warning Icon	<p>1. ON:</p> <p>The unit is shut down due to an internal fault or an environmental fault. The error code will appear on the 7-segment display. Please refer to the following table for each error code and refer to 2.5 Operation Panel - 2.5.4 7-Segment Display for relevant 7-segment display information.</p> <table border="1"> <thead> <tr> <th>Error Code</th> <th>Meaning</th> </tr> </thead> <tbody> <tr> <td>E11</td> <td>Charger Fault</td> </tr> <tr> <td>E12</td> <td>Fan Fault</td> </tr> <tr> <td>E13</td> <td>Over Temperature</td> </tr> <tr> <td>E14</td> <td>+/-DC BUS High/ Low</td> </tr> <tr> <td>E16</td> <td>Inverter Fault</td> </tr> <tr> <td>E18</td> <td>DC-DC Fault</td> </tr> <tr> <td>E19</td> <td>Abnormal Output/ Inverter Voltage</td> </tr> <tr> <td>E21</td> <td>O/P Short</td> </tr> <tr> <td>Sd0</td> <td>REPO Shutdown</td> </tr> <tr> <td>Sd1</td> <td>RPO Shutdown</td> </tr> <tr> <td>Sd2</td> <td>'Shutdown After' Shutdown</td> </tr> <tr> <td>Sd3</td> <td>'Battery Save' Shutdown</td> </tr> <tr> <td>Sd4</td> <td>Battery Low Shutdown</td> </tr> </tbody> </table>	Error Code	Meaning	E11	Charger Fault	E12	Fan Fault	E13	Over Temperature	E14	+/-DC BUS High/ Low	E16	Inverter Fault	E18	DC-DC Fault	E19	Abnormal Output/ Inverter Voltage	E21	O/P Short	Sd0	REPO Shutdown	Sd1	RPO Shutdown	Sd2	'Shutdown After' Shutdown	Sd3	'Battery Save' Shutdown	Sd4	Battery Low Shutdown
Error Code	Meaning																														
E11	Charger Fault																														
E12	Fan Fault																														
E13	Over Temperature																														
E14	+/-DC BUS High/ Low																														
E16	Inverter Fault																														
E18	DC-DC Fault																														
E19	Abnormal Output/ Inverter Voltage																														
E21	O/P Short																														
Sd0	REPO Shutdown																														
Sd1	RPO Shutdown																														
Sd2	'Shutdown After' Shutdown																														
Sd3	'Battery Save' Shutdown																														
Sd4	Battery Low Shutdown																														

No.	Icon	Naming	Description
13		Warning Icon	<p>2. Flashing:</p> <p>When the icon is flashing, it would be accompanied with other icon(s) to show you the according warning message(s).</p> <p>a. : There is no battery or battery replacement is needed.</p> <p>b. : The UPS is overloaded.</p>
14		Load Level Bar Graph	<p>Indicates the status of load level.</p> <p>1. ON:</p> <p>The bar graph illuminates according to the load level *¹.</p> <p>2. Flashing:</p> <p>The bar graph flashes when there is an overload situation.</p>
15		Battery Level Bar Graph	<p>Indicates the status of battery level.</p> <p>1. ON:</p> <p>The bar graph illuminates according to the remaining battery capacity *¹.</p> <p>2. Flashing:</p> <p>The bar graph flashes when a low-battery situation occurs.</p>



NOTE :

*¹ means that:

<10%: no segment will illuminate.

10%-29%: the 1st segment will illuminate.

30%-49%: the first two segments will illuminate.

50%-69%: the first three segments will illuminate.

70%-89%: the first four segments will illuminate.

90%-100%: all segments will illuminate.

2.5.4 7-Segment Display

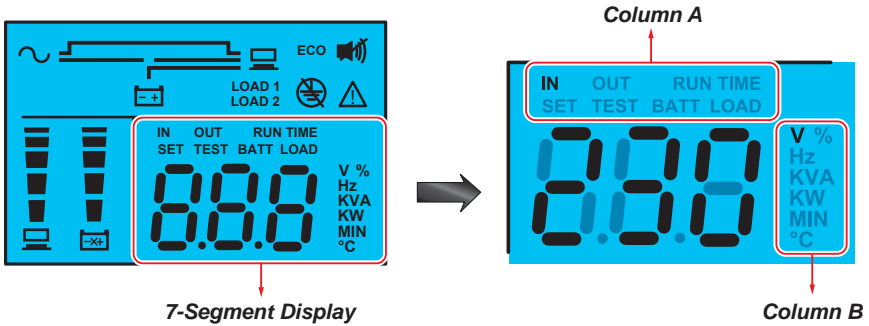

NOTE:

You might need to read the word shown in **Column A** together with that in **Column B** to understand the display meaning.

No.	Icon	Description
1	IN	<p>1. IN & V: When the above two words illuminate together, it means input voltage.</p> <p>2. IN & Hz: When the above two words illuminate together, it means input frequency.</p>
2	OUT	<p>1. OUT & V: When the above two words illuminate together, it means output voltage.</p> <p>2. OUT & Hz: When the above two words illuminate together, it means output frequency.</p>
3	RUN TIME	<p>RUNTIME & MIN: When the above two words illuminate together, it means the estimated remaining backup time.</p>

No.	Icon	Description
4	SET	<p>When the word 'SET' illuminates, it means that the UPS is in the setup mode.</p> <p>You can set up the following items via the LCD. For how to setup, please refer to 5.7 Setup Mode.</p> <ol style="list-style-type: none"> 1. Inverter voltage 2. Inverter frequency 3. Frequency converter 4. Bypass range 5. ECO mode 6. Buzzer 7. Overload alarm
5	TEST	<ol style="list-style-type: none"> 1. When the word 'TEST' flashes, it means that the UPS is under test. 2. When the two words 'TEST' and 'BATT' flash together, it means that the UPS is under battery test.
6	BATT	<ol style="list-style-type: none"> 1. BATT & %: When the above two words illuminate together, it means the remaining battery capacity. 2. BATT & V: When the above two words illuminate together, it means battery voltage.
7	LOAD	<ol style="list-style-type: none"> 1. LOAD & %: When the above two words illuminate together, it means how much the total load has occupied the rated capacity. 2. LOAD & KVA: When the above two words illuminate together, it means how much kVA the total load is. 3. LOAD & KW: When the above two words illuminate together, it means how much kW the total load is.

No.	Icon	Description
7	LOAD	4. LOAD & % & ⚠ : When the above word (LOAD), unit (%) and icon ⚠ flash together, it means that the UPS has an overload situation.
8	V	Means 'voltage'.
9	%	Means 'percentage'.
10	Hz	Means 'frequency'.
11	kVA	Means 'kVA'.
12	kW	Means 'kW'.
13	MIN	Means 'minute'.
14	°C	Means the UPS's internal temperature.

2.5.5 Flow Chart of the 7-Segment Display

The following flow chart helps you to understand how to go through each display screen. Here, we take 'Standby Mode' as an example. Each of the display diagrams shown in below is for reference only. Actual display depends on the operation of the UPS.

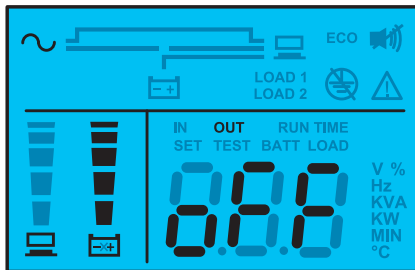

After this screen appears around 10 seconds, the scrolling function will be active. The scrolling button is .

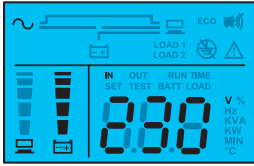

Press the  button for 0.1 second to view the next display.

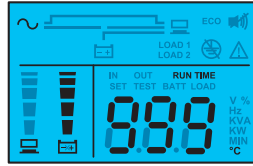

Press the  button for 0.1 second to view the next display.

↓ Press the  button for 0.1 second to view the next display.

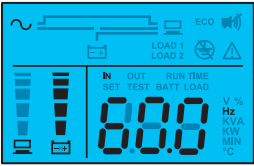

↑ Press the  button for 0.1 second to view the next display.

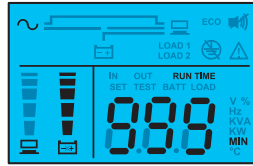

↓ Press the  button for 0.1 second to view the next display.

↑ Press the  button for 0.1 second to view the next display.

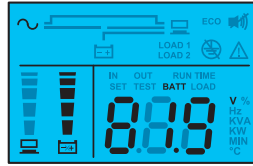
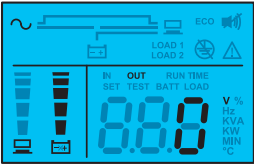

↓ Press the  button for 0.1 second to view the next display.

↑ Press the  button for 0.1 second to view the next display.

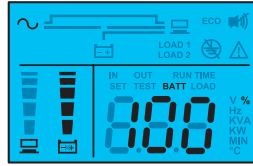
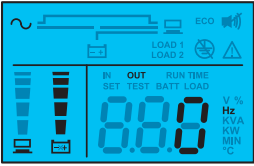

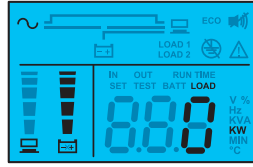
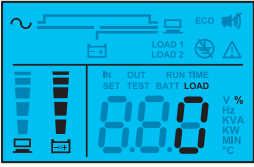

↓ Press the  button for 0.1 second to view the next display.

↑ Press the  button for 0.1 second to view the next display.

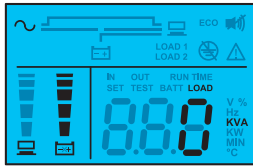

Press the  button for 0.1 second to view the next display.



Press the  button for 0.1 second to view the next display.

2.6 Rear Panel

- 1 kVA

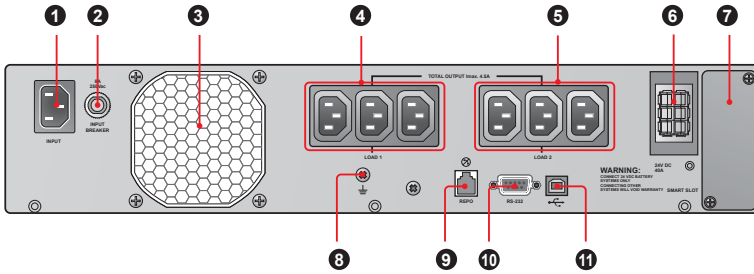

Rear Panel: UPS102R2RT0B035/ UPS102R2RT0B1B1/ UPS102R2RT0B0B6

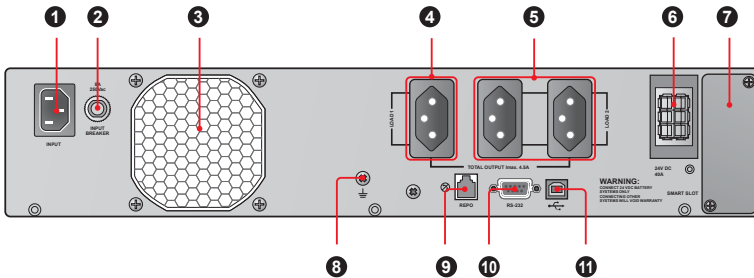

Rear Panel: UPS102R2RT0B0B1

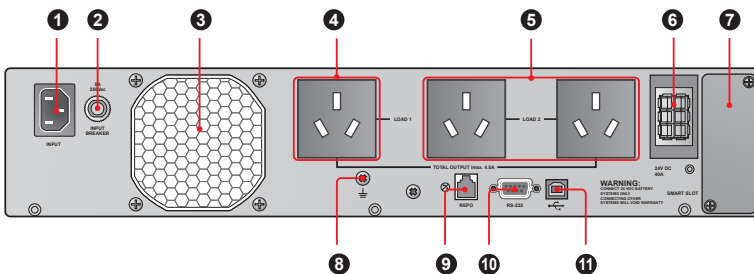

Rear Panel: UPS102R2RT0B0B2

No.	Item	Functions
①	AC Input Socket	Connects the UPS to the mains.
②	Input Breaker	Protects the utility power from further damage when the UPS fails. Please see 6.9 Input Breaker for detailed information.
③	Fan	Cools and ventilates the UPS.
④	Output Receptacles _Load 1	Connect to your loads.
⑤	Output Receptacles _Load 2	Connect to your loads.
⑥	External Battery Pack Connector (24Vdc 40A)	Connects to the Delta external battery pack (optional). Please see 4.2 Delta External Battery Pack (Optional Connection) for detailed information.
⑦	Smart Slot	Accepts SNMP, Relay I/O or ModBus card (optional). Please see Chapter 7 : Communication Interfaces for detailed information.
⑧	Ground Terminal	For UPS grounding
⑨	REPO Port	Shuts down the UPS completely. Please see Chapter 7 : Communication Interfaces for detailed information.
⑩	RS-232 Port	Communication interface port. Please see Chapter 7 : Communication Interfaces for detailed information.
⑪	USB Port	Communication interface port. Please see Chapter 7 : Communication Interfaces for detailed information.

- 2 kVA

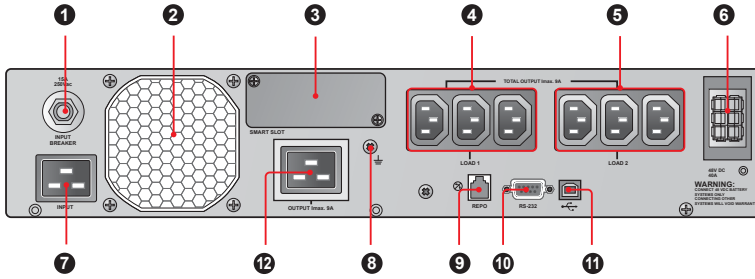

Rear Panel: UPS202R2RT0B035/ UPS202R2RT0B1B1/ UPS202R2RT0B0B6

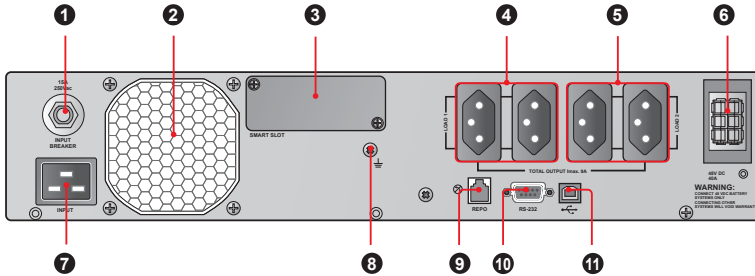

Rear Panel: UPS202R2RT0B0B1

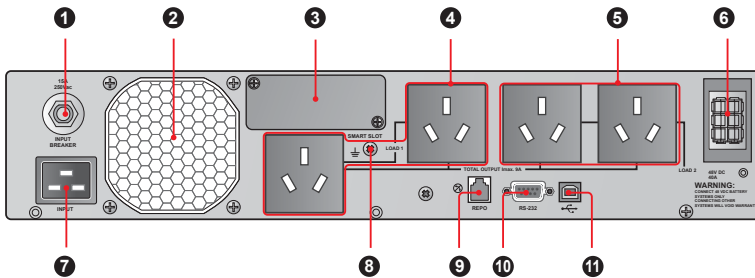

Rear Panel: UPS202R2RT0B0B2

No.	Item	Functions
①	Input Breaker	Protects the utility power from further damage when the UPS fails. Please see 6.9 Input Breaker for detailed information.
②	Fan	Cools and ventilates the UPS.
③	Smart Slot	Accepts SNMP, Relay I/O or ModBus card (optional). Please see Chapter 7 : Communication Interfaces for detailed information.
④	Output Receptacles _Load 1	Connect to your loads.
⑤	Output Receptacles _Load 2	Connect to your load.
⑥	External Battery Pack Connector (48Vdc 40A)	Connects to the Delta external battery pack (optional). Please see 4.2 Delta External Battery Pack (Optional) Connection for detailed information.
⑦	AC Input Socket	Connects the UPS to the mains.
⑧	Ground Terminal	For UPS grounding
⑨	REPO Port	Shuts down the UPS completely. Please see Chapter 7 : Communication Interfaces for detailed information.
⑩	RS-232 Port	Communication interface port. Please see Chapter 7 : Communication Interfaces for detailed information.
⑪	USB Port	Communication interface port. Please see Chapter 7 : Communication Interfaces for detailed information.
⑫	Output Receptacle	Connects to your load.

- 3 kVA

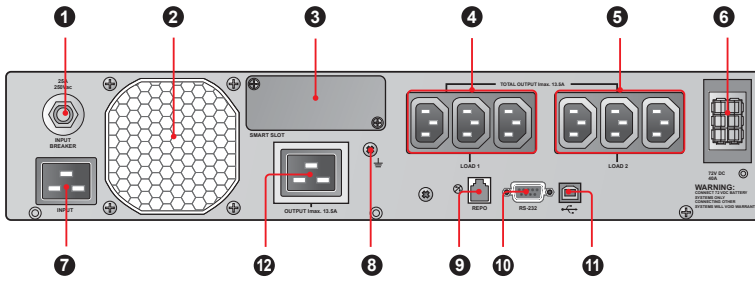

Rear Panel: UPS302R2RT0B035/ UPS302R2RT0B1B1/ UPS302R2RT0B0B6

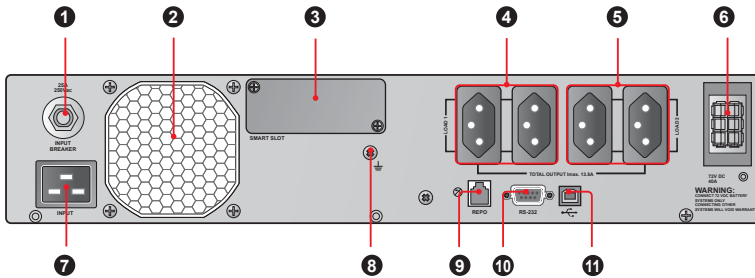

Rear Panel: UPS302R2RT0B0B1

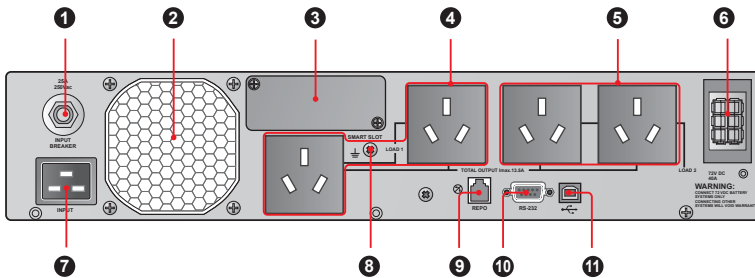

Rear Panel: UPS302R2RT0B0B2

No.	Item	Functions
①	Input Breaker	Protects the utility power from further damage when the UPS fails. Please see 6.9 Input Breaker for detailed information.
②	Fan	Cools and ventilates the UPS.
③	Smart Slot	Accepts SNMP, Relay I/O or ModBus card (optional). Please see Chapter 7 : Communication Interfaces for detailed information.
④	Output Receptacles _Load 1	Connect to your loads.
⑤	Output Receptacles _Load 2	Connect to your load.
⑥	External Battery Pack Connector (72Vdc 40A)	Connects to the Delta external battery pack (optional). Please see 4.2 Delta External Battery Pack (Optional) Connection for detailed information.
⑦	AC Input Socket	Connects the UPS to the mains.
⑧	Ground Terminal	For UPS grounding
⑨	REPO Port	Shuts down the UPS completely. Please see Chapter 7 : Communication Interfaces for detailed information.
⑩	RS-232 Port	Communication interface port. Please see Chapter 7 : Communication Interfaces for detailed information.
⑪	USB Port	Communication interface port. Please see Chapter 7 : Communication Interfaces for detailed information.
⑫	Output Receptacle	Connects to your load.

Chapter 3 : Installation



NOTE :

1. Before installation, please read **Chapter 1. Important Safety Instructions** thoroughly.
2. Each model has internal batteries and each model can connect the Delta external battery pack (optional).
3. Only qualified personnel can perform installation. If you want to install the UPS and the Delta external battery pack (optional) by yourself, installation must be under the supervision of qualified personnel.

3.1 Installation Data

No.	Item	Specification
1	Installation Environment	Indoor only
2	UPS Dimensions	1kVA: 440 x 335 x 89 mm 2kVA: 440 x 432 x 89 mm 3kVA: 440 x 610 x 89 mm
3	Operating temperature	0°C~40°C
4	Relative Humidity (non-condensing)	5%~95%
5	Max. altitude (without de-rating)	1,000 meters above sea level
6	Input power connection	Rear
7	Output power connection	Rear
8	Battery power connection	Rear
9	Air inlet	Front
10	Air outlet	Rear

3.2 Rack Mounting Procedures for the UPS and the Delta External Battery Pack (Optional)

You can rack-mount the UPS and the Delta external battery pack (optional) in a four-post frame. The UPS and the Delta external battery pack (optional) use identical mounting kits and their mounting procedures are the same.



NOTE:

1. The UPS draws cooling air from its front. If your rack has a door on the front, make sure that there is sufficient clearance between the UPS vents and the rack door.
 2. It is strongly recommended that at least two people lift the unit when rack-mounting. If there is only one person available, we suggest that the UPS's internal batteries should be taken out (less weight) before rack-mounting. After rack-mounting, re-install the internal batteries.
 3. Only use the provided bracket ears and rail kits to perform rack-mounting. NEVER depend on lower devices to support the UPS and the Delta external battery pack (optional).
- **Rack-mounting procedures:**
 - 1 Attach the included bracket ears to the lateral mounting holes of the UPS. See **Figure 3-1**.

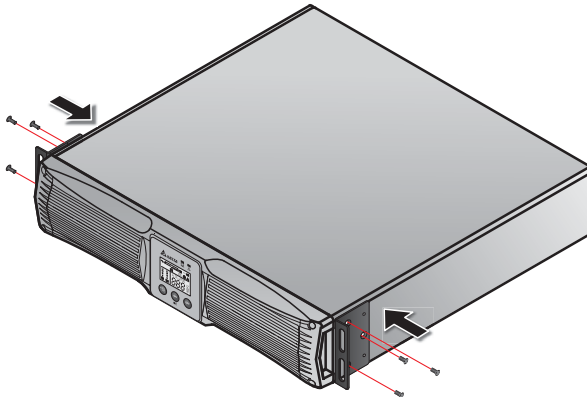

(Figure 3-1 : Mount the Bracket Ears)

- 2 Adjust the length of the provided rails according to your rack and tighten the nuts. See **Figure 3-2**.

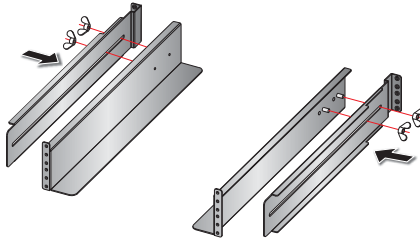

(Figure 3-2 : Adjust the Rails and Tighten the Nuts)

- 3 Use the provided eight screws and eight washers to attach the rails to your rack. See **Figure 3-3**.

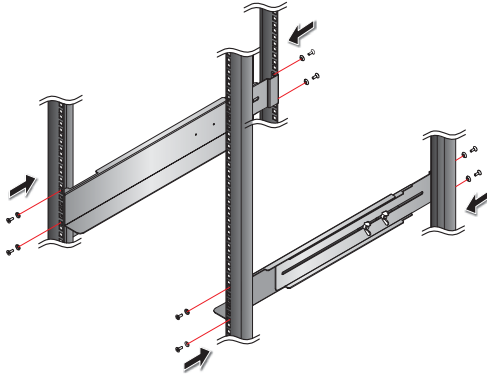

(Figure 3-3 : Attach the Rails to Your Rack)

- 4 Insert the UPS into the rack and tighten the provided four screws. See **Figure 3-4**. Please note that there will be extra four screws left after installation. The four screws are spare parts.

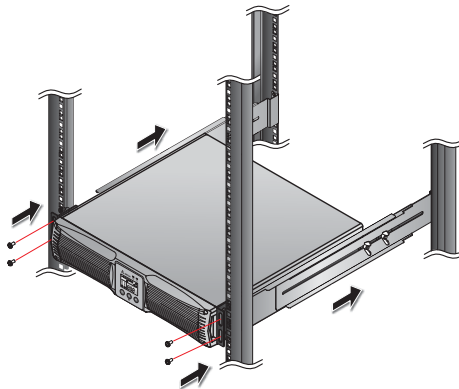

(Figure 3-4 : Insert the UPS into Your Rack)

3.3 Tower Mounting Procedures for the UPS and the Delta External Battery Pack (Optional)

You can mount the UPS and the Delta external battery pack (optional) in an upright position by following the procedures below. The UPS and the Delta external battery pack (optional) use identical mounting kits and their mounting procedures are the same. Please note that the package does not include any tower-mounting kits. If you need to purchase any, please contact Delta customer service and refer to **Chapter 9: Optional Accessories**.



NOTE:

1. The tower stand picture shown below is just descriptive.
2. Leave adequate space at least 15cm in front and at rear of the UPS for proper ventilation.

- **Tower mounting procedures:**

- ① Remove the four screws from the front plastic panel. See **Figure 3-5**.

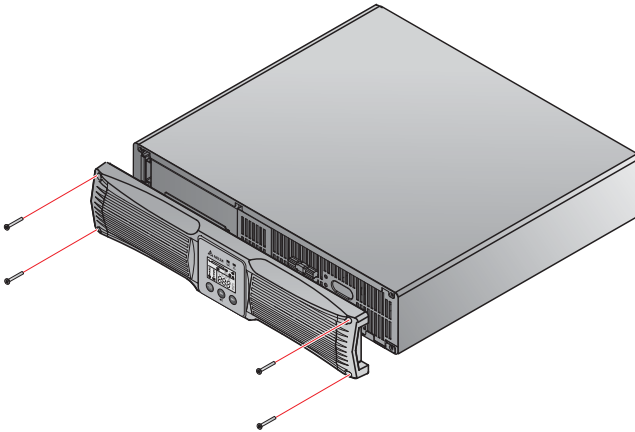

(Figure 3-5 : Remove the Front Plastic Panel)

- ② From the back of the front plastic panel, carefully push the backside of the operation panel until it slides out of the front plastic panel. Please handle with care to avoid damaging the cable connecting the operation panel and the UPS's internal connector. See **Figure 3-6**.

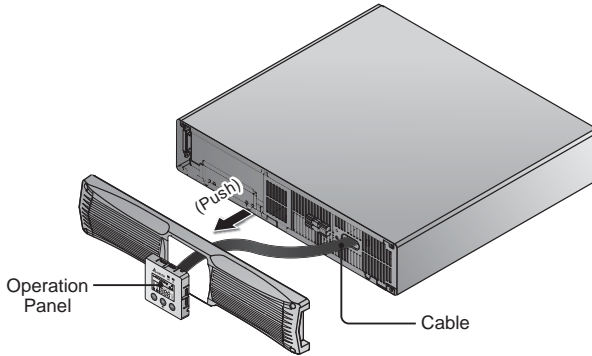

(Figure 3-6 : Push the Backside of the Operation Panel)

- 3 Rotate the operation panel 90° clockwise ① and re-install it back into the front plastic panel ②. Replace the front plastic panel and make sure the four screws are tightly fixed ③. See **Figure 3-7**.

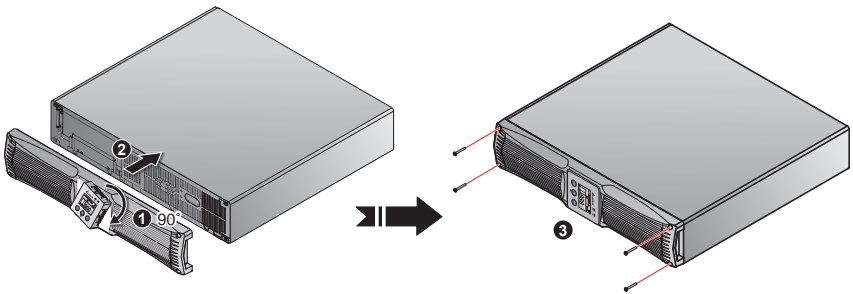

(Figure 3-7: Rotate the Operation Panel (90° Clockwise), Reinstall It, and Replace the Front Plastic Panel)

- 4 Assemble the tower stands (optional) by inserting the tenons into the grooves according to the size of the UPS. See **Figure 3-8**.

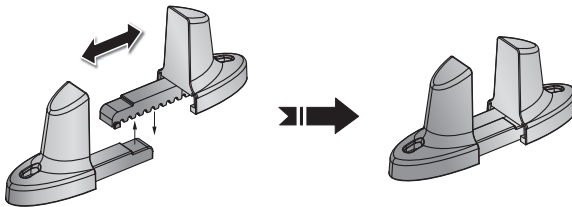

(Figure 3-8: Assemble the Tower Stands (Optional))

- 5 Carefully lift the UPS upright (at least two people are required) with the Delta logo shown on the operation panel facing up. See **Figure 3-9**.

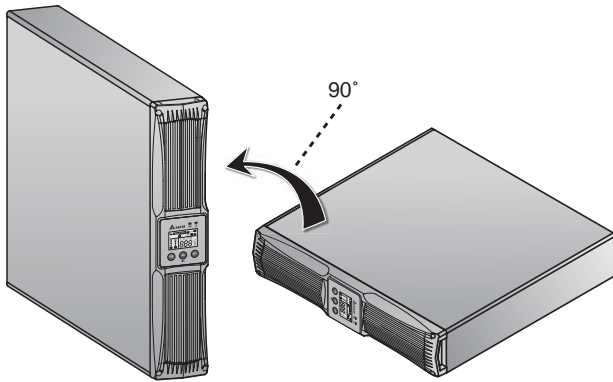

(Figure 3-9: Place the UPS Upright)

- 6 Place the UPS inside the tower stands (at least two people are required). See **Figure 3-10**.

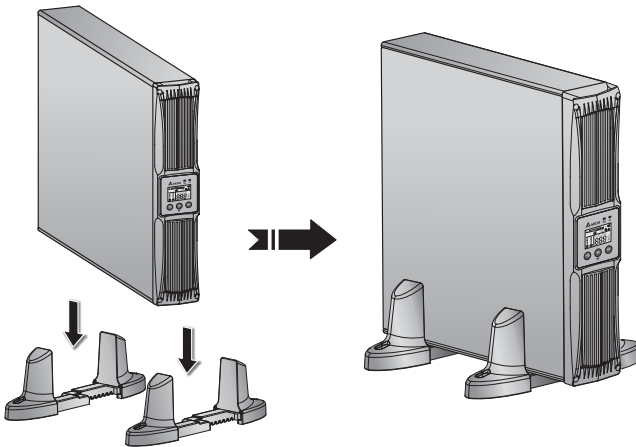

(Figure 3-10: Place the UPS Inside the Tower Stands (Optional))

Chapter 4 : Connections

4.1 Pre-connection warnings

1. Before connection, please read **Chapter 1: Important Safety Instructions** thoroughly.
2. The UPS is supplied with standard power cords and receptacles suitable for its use in your area of operation. Only qualified personnel can perform installation, wiring, operation and maintenance.
3. Before connecting any input wiring to the UPS, ensure that all circuits being used are proper voltage and current required for the UPS. The power supply to the UPS must be single-phase in accordance with its rating label.
4. Calculate the power consumption of the connected loads to ensure that an overload condition will not occur.
5. Prior to providing any power to the UPS, the UPS must be suitably grounded. The unit is equipped with a safety-inspected mains line and must be connected to an earthing-contact wall socket. If the wall socket does not have an earthing function, please ground the UPS via the ground terminal located at the rear of the UPS. Please see **2.6 Rear Panel**.

4.2 Delta External Battery Pack (Optional) Connection

**NOTE :**

1. Please read **4.1 Pre-connection Warnings** before connection.
2. Before connecting the Delta external battery pack (optional) to the UPS, check whether the rating voltage of the battery pack is suitable for the UPS.

Please see the following figure for the rear view of the Delta external battery pack (optional). There are three different ratings, 24Vdc, 48Vdc and 72Vdc. Please select the correct rating of the battery pack for your UPS.

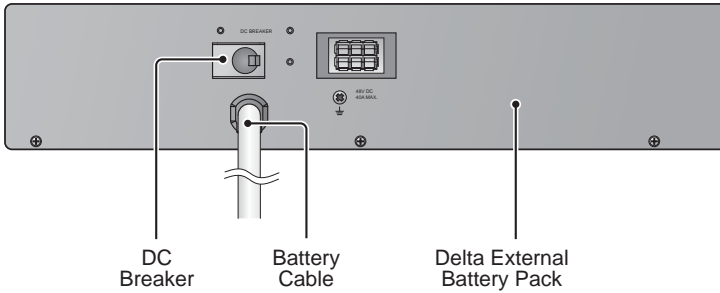

(Figure 4-1 : Delta External Battery Pack Rear View)

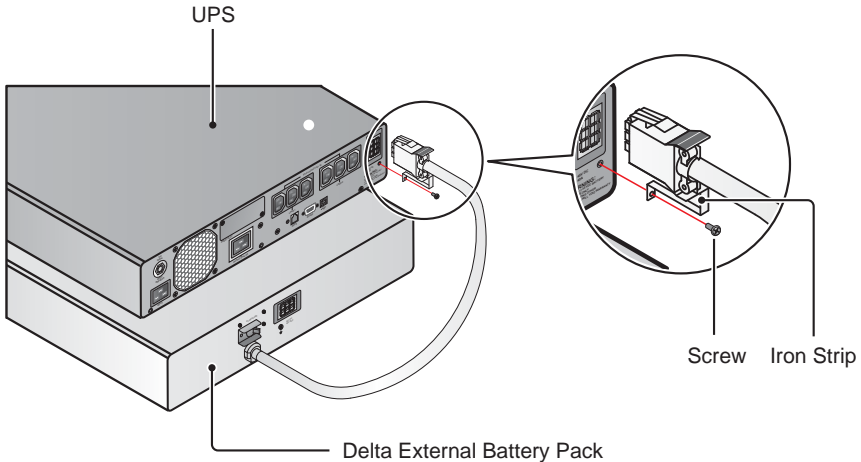

- 1 Set the battery pack's DC breaker to the OFF position.
- 2 Remove the cover of the external battery pack connector located on the rear side of the UPS.
- 3 Connect the battery cable attached to the Delta external battery pack (optional) to the UPS's battery pack connector. Make sure the battery cable's iron strip shown in the figure below is tightly screwed. Here, we take the UPS202R2RT0B035 model as an example; please see **Figure 4-2**.



(Figure 4-2 : Connect the UPS and the Delta External Battery Pack (Optional))

- 4 Set the battery pack's circuit breaker to the ON position.
- 5 Use either the UPSentry 2012 software (included in the provided CD) or the LCD to set up the battery pack number.

**NOTE :**

1. If the UPS is going to run for the 1st time, before operation, please fully charge the batteries (internal and external) until the Battery Level Bar Graph  shown on the UPS's LCD is fully on.
2. Normally, the life of a battery is 3–5 years. However, an extreme operating condition and environment may shorten its life-span.
3. When the UPS has not been used for a period of time, the batteries will discharge slightly. It is recommended to charge the batteries (internal and external) once every 3 months, and each time, fully charge them until the Battery Level Bar Graph  shown on the UPS's LCD is fully on.
4. Safety Requirement:
For convenient removal of the battery power cord in an emergent situation, please arrange and organize each cable/ wire connecting to the UPS and the Delta external battery pack (optional) well.

4.3 Communication Interface Connection

The RT 1–3kVA series UPS's communication interfaces include an RS-232 port, a USB port, a smart slot and an REPO port. Please refer to **2.6 Rear Panel** for their locations. You can use all of the communication interfaces at the same time and it won't influence each interface's function. For more information, please refer to **Chapter 7 : Communication Interfaces**.

4.4 Critical Load Connection

1. Please read **4.1 Pre-connection Warnings** before connection.
2. Calculate power consumption of your loads to ensure that an overload condition will not happen.
3. 1kVA model has 10A output outlets at the rear. 2kVA/ 3kVA model has 10A output outlets and one 16A output outlet at the rear.
4. Please follow your loads to select proper cables to connect the UPS output outlets and the loads.
5. Plug the power cord of the equipment into the output receptacles located at the rear of the UPS.



WARNING: Do not connect laser printers or scanners to the UPS.

4.5 Utility Power Connection

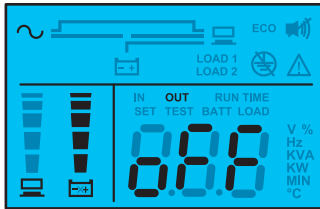

1. Please read **4.1 Pre-connection Warnings** before connection.
2. Use the provided input cable to connect the UPS and a wall socket that has an earthing-contact function. If the wall socket does not have an earthing connection, please ground the UPS via the ground terminal. Please see **2.6 Rear Panel** for ground terminal location.
3. After the UPS is connected to the AC utility, the utility will supply power to the UPS. After that, the fan (at the rear panel) will run, all LEDs and LCD will be on for about 2-3 seconds. The user can check whether the LEDs and LCD are normal. The default setting of the UPS is set in 'STANDBY mode' (see **Figure 4-3**). Please note that once the AC utility supplies power to the UPS, the batteries will be charged.



(Figure 4-3 : Initial Screen after Utility Power Connection_ Standby Mode)



NOTE :

1. The diagram shown above is for reference only. Actual display depends on the operation of the UPS.
2. The UPS will charge its internal batteries and the optional Delta external battery pack (if connected and its DC breaker is turned on) whenever the UPS is connected to the AC source.
3. It is recommended that you fully charge the UPS's internal and external batteries until the Battery Level Bar Graph  shown on the UPS's LCD is fully on. If you don't do this, you may use the UPS immediately but the 'On-Battery' runtime might be less than normally expected.
4. If the UPS is going to be out of service or stored for a prolonged period of time, you must recharge the batteries (internal and external) every three months and, every time, fully charge the batteries (internal and external) until the Battery Level Bar Graph  shown on the UPS's LCD is fully on.
5. The batteries will immediately begin charging upon the availability of the input power.

Chapter 5 : Operation Modes

**NOTE :**

1. Please refer to **2.5 Operation Panel** to learn how to operate the operation panel and understand the display meaning.
2. Each of the display diagrams shown in this chapter is for reference only. Actual display depends on the operation of the UPS.

5.1 Standby Mode

After the UPS is connected to the AC utility, it will supply power to the UPS and the batteries will be charged. The default setting of the UPS is set in 'STANDBY mode'.

5.2 On-line Mode

In online mode, the connected loads are supplied by the inverter, which derives its power from the utility AC power, and the UPS charges the batteries and provides power protection to its connected loads.

5.3 Bypass Mode

In bypass mode, the critical loads are directly supplied by the utility power and the batteries are charged.

5.4 Battery Mode

When the UPS is operating during a power outage, the batteries provide DC power, which maintains inverter operation to support the connected critical loads.

You can use the UPSentry 2012 software (included in the provided CD), SNMP card (optional), or ModBus card (optional) to monitor and estimate the battery remaining capacity before or during an AC power failure. For more information about the SNMP card (optional) or the ModBus card (optional), please refer to its user manual.

**NOTE :**

You can only enable 'SHUTDOWN AFTER' function in battery mode. For information about 'SHUTDOWN AFTER' function, please contact service personnel.

5.5 ECO Mode

You can manually set the UPS to run in ECO mode. For setup information, please refer to **5.7 Setup Mode**.

In ECO mode, when the utility input voltage and frequency are within the range of rating voltage $\pm 10\%$ and rating frequency $\pm 5\text{Hz}$, the connected loads are supplied by the utility power; if out of the range, the connected loads are supplied by the inverter.

5.6 Frequency Converter Mode

When the UPS is manually set in frequency converter mode, the output frequency can be set as 50Hz or 60Hz. For setup information, please refer to **5.7 Setup Mode**.

After the output frequency is set up, the system will automatically disable the bypass function. Please note that once the inverter shuts down, there is no bypass output.



5.7 Setup Mode



Press the scrolling button  for more than 3 seconds and the LCD will go into the setup menu.

Please note that only qualified service personnel can perform setup action. In setup mode, you can set up the following items:

1. Inverter voltage
2. Inverter frequency
3. Frequency converter
4. Bypass range
5. ECO mode
6. Buzzer
7. Overload alarm

For setup procedures, please refer to the following:

1. Press the scrolling button  for more than 3 seconds to enter into the setup mode.
2. Press the scrolling button  for 0.1 second to change the parameter.

3. Press the confirmation button  for 0.1 second to confirm your parameter, and at the same time, the LCD will go to the next setup item.
4. You can skip to the next setup item by pressing the cancel button  for 0.1 second.
5. In setup mode, press the scrolling button  for more than 3 seconds, the LCD will go back to the original display.
6. In setup mode, if you don't press any button for more than 2 minutes, the LCD will exit from the setup mode and go back to the original display automatically.

For some settings, they can't be set in certain operation modes. Please refer to the table below for relevant information.

Setup Item	Standby Mode	On-line Mode	Bypass Mode	Battery Mode	ECO Mode	Frequency converter mode
Inverter Voltage Setup	✓	✗	✓	✗	✗	✗
Inverter Frequency Setup	✓	✗	✓	✗	✗	✗
Frequency Converter Setup	✓	✗	✓	✗	✗	✗
Bypass Range Setup	✓	✓	✓	✓	✓	✓
ECO Setup	✓	✓	✓	✓	✓	✗
Buzzer Setup	✓	✓	✓	✓	✓	✓
Overload Alarm Setup	✓	✓	✓	✓	✓	✓



NOTE: Please note that only qualified service personnel can perform setup action.

Setup Mode Flow Chart

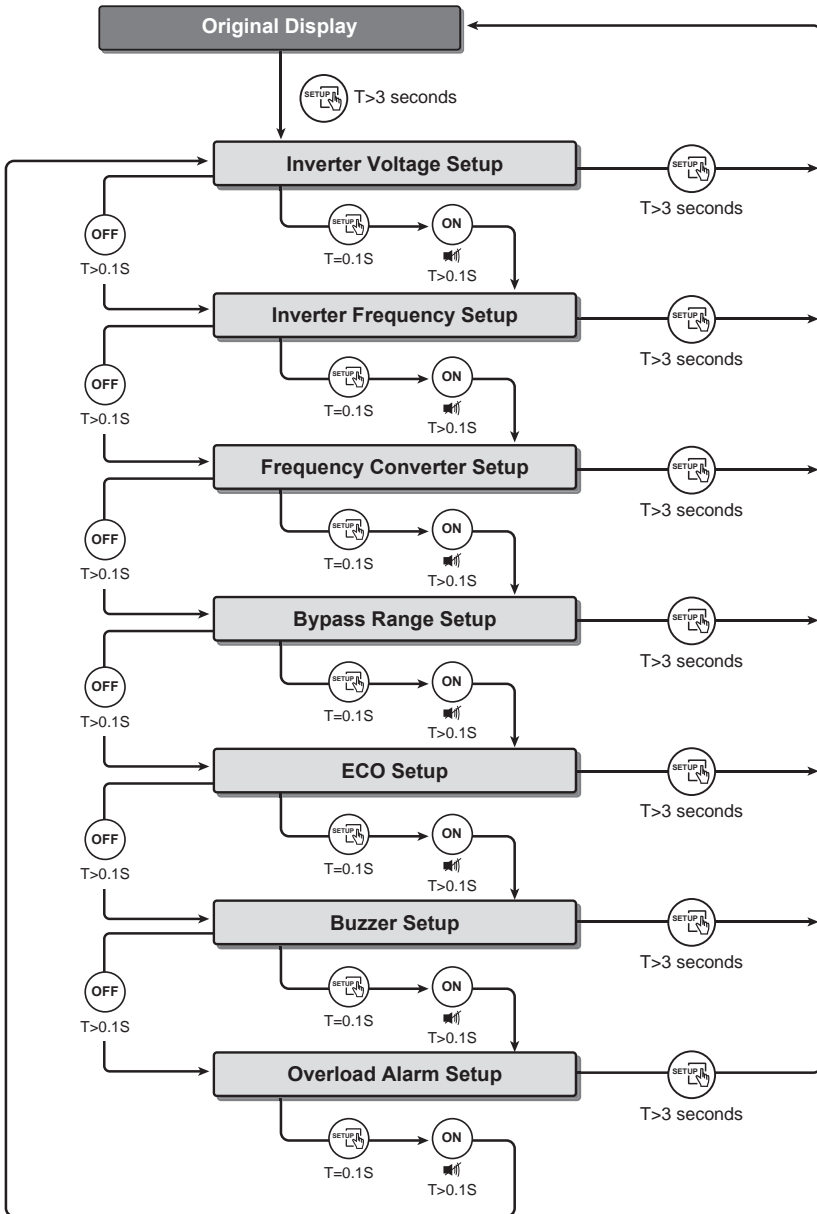

Chapter 6 : Operation



NOTE :

1. Please refer to **2.5 Operation Panel** to learn how to operate the operation panel and understand the display meaning.
2. Please refer to **2.6 Rear Panel** and **Chapter 7 : Communication Interfaces** to understand how to use the UPS interfaces.

6.1 Start-up Procedures

After the UPS is connected to the AC utility, the AC utility supplies power to the UPS. The UPS is initially set in 'STANDBY mode'. To turn on the UPS, press and hold the  button for 3 seconds and release it after you hear one beep.

6.2 Shutdown Procedures

1. In on-line mode, if you want to turn off the UPS, press and hold the  button for 3 seconds and release it after you hear one beep. The inverter will turn off and the UPS will transfer to standby mode.

The UPS will keep charging the batteries when the UPS is in standby mode even though the  button has been pressed. To fully turn off the UPS, it is advised to unplug the power cord.

2. In battery mode, if you want to turn off the UPS, press and hold the  button for 3 seconds and release it after you hear one beep. The UPS will turn off its output.

6.3 Cold Start

Even when there is no utility power, you can still turn on the UPS. Just press and hold the  button for 3 seconds, release it after you hear one beep, and the UPS will start up and run in battery mode.

6.4 Silence Function





If the buzzer is on, press the  button and the buzzer will be off. If any new alarm occurs, the buzzer will be turned on again.

6.5 Battery Test

Battery test can only be executed in on-line mode and in ECO mode.

1. For automatic regular battery test, you must install the UPSentry 2012 software (included in the provided CD), or configure the SNMP card (optional) or ModBus card (optional).
2. For manual battery test, please press and hold the  button for 3 seconds, release it after you hear one beep, and the UPS will transfer to run in battery mode and perform a 10-second battery test.

If the test result is ok, the LCD will show 'PAS' and the UPS will return to on-line mode or ECO mode (according to its original operation mode).

If the test result is abnormal, the LCD will show 'FAL', the LED   will flash, the warning icon  and no-battery/ battery replacement icon  will illuminate, and the UPS will return to on-line mode or ECO mode (according to its original operation mode).

6.6 Alarm

No.	Condition	Alarm
1	Battery Mode	The audible alarm beeps once every 2 seconds.
2	Low Battery	The audible alarm beeps once every 0.5 second.
3	Battery Missing/ Weak Battery/ Battery Replacement/ *2	The audible alarm beeps once every 2 seconds.
4	Overload	The audible alarm beeps constantly.
5	Fault	The audible alarm beeps constantly when the UPS detects an internal fault.





NOTE:

*2 After reconnecting or replacing the batteries, it might take a while for the UPS to switch off the alarm automatically. If, after a period of time, the audible alarm still exists, the user must manually initiate a battery test (press and hold the  button for 3 seconds and release it after you hear one beep) to clear the alarm.

6.7 De-rating Power

When the input voltage range is between 100Vac and 160Vac, the UPS's load capacity will decrease. This function provides a wider operating power voltage range.

6.8 Online Mode/ Battery Mode Overload Cut-off

1. When the UPS is 105% ~125% overloaded either in online mode or in battery mode, the Load Level Bar Graph  will flash, the alarm will beep constantly, and the UPS will completely shut down within 1 minute.
2. When the UPS is 125% ~150% overloaded either in online mode or in battery mode, the Load Level Bar Graph  will flash, the alarm will beep constantly, and the UPS will completely shut down within 15 seconds.
3. In online mode, when the UPS is >150% overloaded, the Load Level Bar Graph  will flash, the alarm will beep constantly, and the UPS will transfer to bypass mode.

In battery mode, when the UPS is >150% overloaded, the Load Level Bar Graph  will flash, the alarm will beep constantly, and the UPS will immediately shutdown.

6.9 Input Breaker

- When input power has an over current issue in online mode, the input breaker at the rear of the UPS will automatically activate and the unit will transfer to battery mode. After the abnormal issue is solved, press the input breaker and the unit will automatically switch back to online mode.
- When input power has an over current issue in online mode, the input breaker at the rear of the UPS will automatically activate. If there is no battery power, the UPS will automatically shut down. After the abnormal issue is solved, press the input breaker and follow the start-up procedures to start up the UPS.



NOTE :

When the input breaker automatically activates, it means that something wrong with the UPS or its connected loads. It is highly recommended that you turn off the UPS, remove the input power cord, and let qualified service personnel carefully inspect the UPS, its connected loads and the surrounding environment.

6.10 Generator Compatible

The UPS can operate with most of the generators available in the market.

Chapter 7 : Communication Interfaces



NOTE: The UPS can still function properly without making the connections below.

The UPS's communication interfaces include an RS-232 port, a USB port, a smart slot and an REPO port. Please refer to **2.6 Rear Panel** for their locations. You can use all of the communication interfaces at the same time and it won't influence each interface's function.

- **RS-232 Port**

You can use an RS-232 cable (not provided) to connect the UPS with a computer and use the included CD to install the UPSentry 2012 software to record UPS power events, monitor UPS status, adjust transfer voltage, set up alarms, and shut down the UPS safely in a network environment. The pin assignment of the RS-232 port is defined as follows:

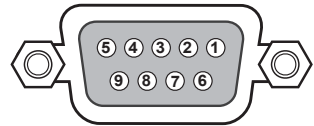

(Figure 7-1: RS-232 Port)

Pin	RS-232 Pin Assignment Description
2	UPS TXD (Typical RS-232 level)
3	UPS RXD (Typical RS-232 level)
5	GND

Communication Setting for RS-232 Port	
Baud Rate	2400
Data Length	8 bits
Stop Bit	1 bit
Parity	None

RS-232 Other Pin Applications: Alarm Signal & Remote Shutdown

Condition	Pin	Action
Low Battery	8 & 5	The signal activates when the battery capacity is below the threshold.
On Battery	1 & 5	The signal activates when the UPS runs in battery mode.
Remote Shutdown	3 & 9	Remote shutdown is ONLY applicable in battery mode. For remote shutdown, short Pin 3 and Pin 9 for approximate 3.8 seconds, and then the UPS will shut down after one minute.



NOTE: Other pins are reserved and cannot be used.

- **USB Port**

Besides the RS-232 port, the UPS also provides another channel, USB port, for user to record UPS power events, monitor UPS status, adjust transfer voltage, set up alarms, and shut down the UPS safely via a computer. Simply plug the USB cable into the UPS and your computer, install the UPSentry 2012 software (included in the provided CD), and follow the prompts on your screen to complete the software installation.

- **Smart Slot**

You can choose optional cards to monitor the UPS or to enhance the UPS function. The list of optional cards is shown in the table below.

Optional Card	Function
SNMP Card (IPv4 or IPv6)	Helps you remotely monitor and control the status of the UPS via a network system.
Relay I/O Card	Increases the quantity of dry contacts.
ModBus Card	Lets the UPS have ModBus communication.



NOTE: For more detailed information about optional cards, please contact service personnel. If you need to purchase any optional card, please contact your local dealer or customer service.

• REPO Port

The REPO port allows the user to shut down the UPS in online mode or in battery mode when an emergency occurs. Use a RJ11 cable (not provided) to connect the REPO port and a user-supplied switch.

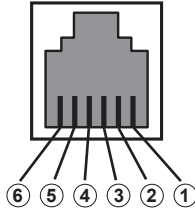

(Figure 7-2: REPO Port)

If the user-supplied switch is a normally-closed one, please short pin 3, pin 4 and pin 5 for approximately 1 second to shut down the UPS. Please refer to the following figure.

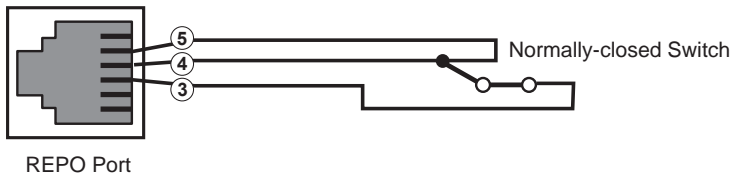

(Figure 7-3: REPO Port Configuration for a Normally-closed Switch)

If the user-supplied switch is a normally-open one, please short pin 4 and pin 5 for approximately 1 second to shut down the UPS. Please refer to the following figure.

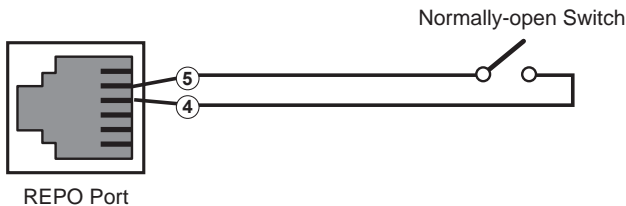

(Figure 7-4: REPO Port Configuration for a Normally-open Switch)



WARNING: Do not connect a telephone line to the REPO port.

Chapter 8 : Internal Battery Replacement



Warning:

1. Turn off the UPS and cut off the AC source before performing battery/ battery pack replacement.
2. A battery can present a risk of electrical shock and high short-circuit current.
3. Servicing of batteries and battery packs should be performed or supervised by qualified service personnel knowledgeable in batteries, battery packs and the required precautions.
4. Only use the same type of batteries from the same supplier. Never use old, new and different Ah batteries at the same time. The types of batteries are HRC9-12 (BB), HR9-12 (BB), HR1234WF2 (CSB), CP1290 (Center Power), HPS12-36W (Center Power), HRC1234W (BB), LP12-9.0 (Leoch) and SSP12-9 (SACRED SUN).
5. Keep unauthorized personnel away from batteries and battery packs.
6. The following precautions should be observed before replacement of batteries:
 - Remove watches, rings, or other metal objects.
 - Use tools with insulated handles.
 - Wear rubber gloves and boots.
 - Do not lay tools or metal parts on top of batteries.
 - Disconnect charging source prior to connecting or disconnecting battery terminals.
7. Please read **Battery Precautions** stated in **Chapter 1: Important Safety Instructions** before replacing batteries.

The 1kVA, 2kVA and 3kVA UPSs contain two, four, and six internal batteries respectively. Below, we take 1kVA model as an example to describe the internal battery replacement procedures.

- 1 Remove the UPS's front plastic panel (there are four screws).

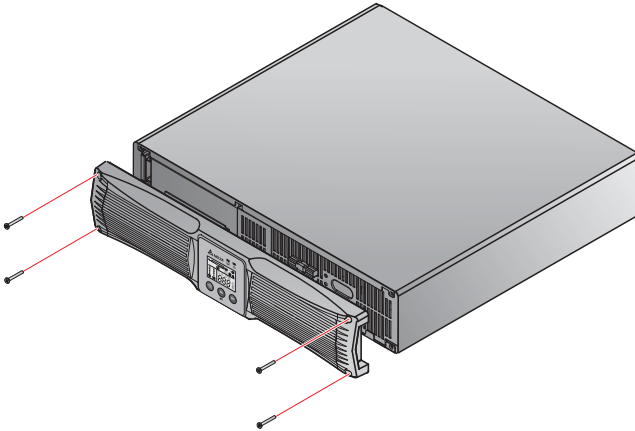

(Figure 8-1 : Remove the Front Plastic Panel)

- 2 From the back of the front panel, carefully push the backside of the operation panel until it slides out of the front plastic panel. Please handle with care to avoid damaging the cable connecting the operation panel and the UPS's internal connector. See **Figure 8-2**.

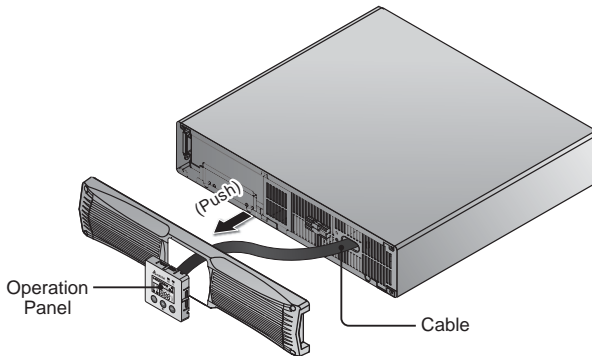

(Figure 8-2 : Push the Backside of the Operation Panel)

- 3 Put the front plastic panel aside.

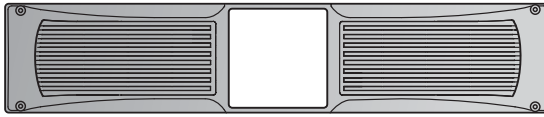

(Figure 8-3: Put the Front Plastic Panel Aside)

- 4 Disconnect the battery cables.

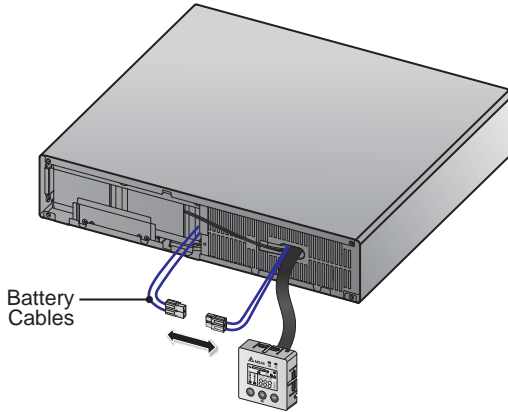

(Figure 8-4: Open the Connector Holder and Disconnect the Battery Cables)

- 5 Remove the two screws shown in the following figure.

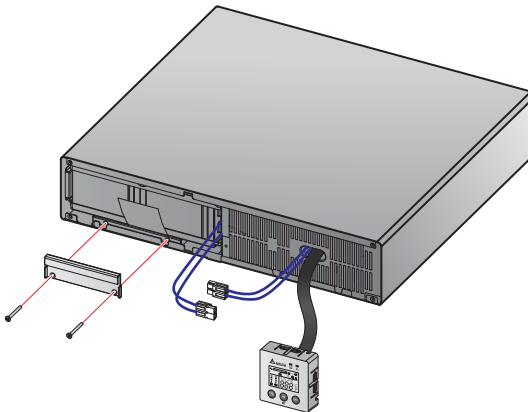

(Figure 8-5: Remove the Two Screws)

- 6 Pull out the tab carefully to take out the internal batteries.

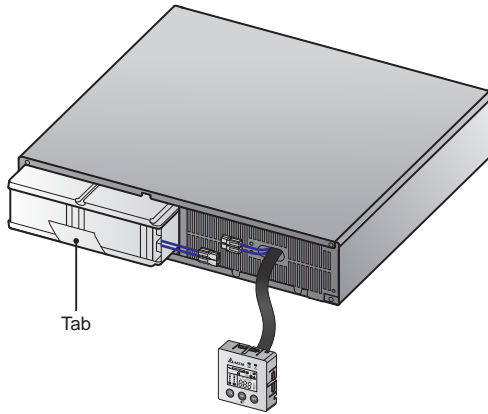

(Figure 8-6: Pull out the Tab to Take out the Internal Batteries)

- 7 Insert the new batteries and reverse the procedures mentioned above to complete battery replacement.

Chapter 9 : Optional Accessories

There are several optional accessories available for this RT 1-3kVA series UPS. Please refer to the table below for the optional accessories and their functions.

No.	Item	Function
1	Tower Stands	Sustain the UPS vertically.
2	Delta External Battery Pack	Provides external batteries that let the UPS supply power to the loads connected when a power failure occurs.
3	EnvioProbe	Monitors temperature, humidity and other conditions in a room environment.  NOTE: The EnvioProbe should work with either an SNMP card or an EMS2000.
4	SNMP Card (IPv4 or IPv6)	Monitors and controls the status of the UPS via a network system.
5	Relay I/O Card	Increases the quantity of dry contacts.
6	ModBus Card	Lets the UPS have ModBus communication function.



NOTE:

1. For detailed installation and operation of any accessory mentioned above, please refer to the Quick Guide, User Guide, or Installation & Operation Guide included in the package of the relevant optional accessory.
2. If you want to buy any accessory mentioned above, please contact your local dealer or customer service.

Chapter 10 : Maintenance

10.1 UPS

- **UPS Cleaning**

Regularly clean the UPS, especially the slits and openings, to ensure that the air freely flows into the UPS to avoid overheating. If necessary, use an air-gun to clean the slits and openings to prevent any object from blocking or covering these areas.

- **UPS Regular Inspection**

Regularly check the UPS every half year and inspect:

1. Whether the UPS, LEDs, and alarm function are operating normally.
2. Whether battery voltage is normal. If battery voltage is too high or too low, find the root cause.

10.2 Batteries

The RT 1-3kVA series UPS uses sealed lead-acid batteries. Though the typical battery life cycle is 3~5 years, the battery life depends on the temperature, the usage, and the charging/ discharging frequency. High temperature environments and high charging/ discharging frequency will quickly shorten the battery life. The UPS does not require maintenance by the user; however, the batteries should be checked periodically. Please follow the suggestions below to ensure a normal battery lifetime.

- Keep the usage temperature at 20°C ~25°C.
- Idle batteries must be fully recharged every three months if the UPS needs to be stored for an extended period of time. Please fully charge the batteries (internal and external) until the Battery Level Bar Graph  shown on the UPS's LCD is fully on.



NOTE: If the UPS's internal batteries need to be replaced, please contact qualified service personnel. During battery replacement, the loads attached to the UPS will not be protected if input power fails.

10.3 Fan

Higher temperatures shorten fan life. When the UPS is running, please check if each fan works normally and make sure if the ventilation air can move freely around and through the UPS. If not, contact service personnel.



NOTE:

Please ask your local dealer or customer service for more maintenance information. Do not perform maintenance if you are not trained for it.

Chapter 11 : Troubleshooting

1. When a problem occur, please check if the following situation exists before contacting Delta service personnel:
 - Is the main input voltage present?
2. Please have the following information ready if you would like to contact the Delta service personnel:
 - Unit information including model, serial number, etc.
 - An exact description of the problem. The more detailed description of the problem, the better.
3. When you see the following problems occur, please follow the solutions shown below.

A. About the error codes shown on the 7-segment Display

Error Code	Meaning	Possible Cause	Solution
E11	Charger Fault	Charger is damaged.	Contact service personnel.
E12	Fan Fault	Fan is damaged or stuck.	<ol style="list-style-type: none"> 1. Check if foreign matter is stuck in the fan. If yes, please remove it. 2. Contact service personnel.
E13	Over Temperature	The UPS temperature is too high.	<ol style="list-style-type: none"> 1. Check whether the UPS's ventilation is normal. 2. Decrease the loads. 3. Check whether the fan runs normally. 4. Clean the filters (if you have installed any)
E14	+/-DC BUS High/ Low	The UPS has abnormalities.	Contact service personnel.

Error Code	Meaning	Possible Cause	Solution
E16	Inverter Fault	The UPS has abnormalities.	Contact service personnel.
E18	DC-DC Fault	The UPS has abnormalities.	Contact service personnel.
E19	Abnormal Output/ Inverter Voltage	The UPS has abnormalities.	Contact service personnel.
E21	O/P Short	Output has a short-circuit issue.	1. Check whether the output has a short-circuit issue. 2. Contact service personnel.
Sd0	REPO Shutdown	Emergent shutdown is executed.	After emergency events are eliminated, follow the turn-on procedures to start up the UPS.
Sd1	RPO Shutdown	Remote shutdown is executed from dry contact.	After the remote shutdown events are eliminated, follow the turn-on procedures to start up the UPS.
Sd2	'Shutdown After' Shutdown	'Shutdown After' shutdown is enabled.	Contact service personnel.
Sd3	'Battery Save' Shutdown	When the total load is too small or when there is no load connected to the UPS, 'Battery Save' shutdown will be enabled after the UPS has run in battery mode for 30 minutes.	Contact service personnel.

Error Code	Meaning	Possible Cause	Solution
Sd4	Battery Low Shut-down	The UPS transfers to run in battery mode due to AC utility abnormality; however, the battery power is almost used up.	<ol style="list-style-type: none"> 1. Check the main AC source and the main power cord's status. 2. Contact service personnel.

B. About other problems that might happen

No.	Problem	Possible Cause	Solution
1	Overload	The UPS is overloaded.	Decrease your connected loads.
2	Battery Missing	<ol style="list-style-type: none"> 1. Wrong battery wiring. 2. Battery cables are not connected or not firmly connected. 	<ol style="list-style-type: none"> 1. Contact service personnel. 2. Connect the battery cables and connect them firmly.
3	Weak Battery/ Battery Replacement	Batteries are damaged or battery life time is due.	Contact service personnel.



NOTE :

If all possible causes are eliminated but the alarm still appears, please contact your local dealer or customer service.

Appendix 1 : Technical Specifications

Model		RT-1K	RT-2K	RT-3K
Power Rating		1kVA/0.9KW	2kVA/1.8KW	3kVA/2.7KW
Waveform		Pure Sine Wave		
Input	Nominal Voltage	200* ¹ , 208* ¹ , 220, 230, 240 Vac		
	Voltage Range	220/230/240 Vac: 175 ~ 280 Vac (100% load); 120 ~ 175 Vac (70% ~ 100% load) 200/208 Vac: 160 ~280 Vac (100% load); 120 ~ 160 Vac (70% ~ 100% load)		
	Frequency	50/60 Hz ± 10 Hz		
	Power Factor	> 0.99 (full load)		
	iTHD	<5%		
Output	Power Factor	0.9		
	Voltage	200* ¹ , 208* ¹ , 220, 230, 240 Vac		
	Voltage Regulation	± 2% (linear load)		
	Frequency	50/60 Hz ± 0.05 Hz		
	vTHD	< 3% (linear load)		
	Overload Capability	< 105%: Continuous 105% ~ 125%: 1 minute; 125% ~ 150%: 15 seconds		
	Cress Factor	3:1		

Model		RT-1K	RT-2K	RT-3K
Output	Connection Suffix B035	IEC C13x3x2	IEC C13x3x2, IEC C19x1	IEC C13x3x2, IEC C19x1
	Connection Suffix B0B1	Brazil socket x3	Brazil socket x4	Brazil socket x4
	Connection Suffix B0B2	Argentina socket x3	Argentina socket x4	Argentina socket x4
Efficiency	Online Mode	90%	Up to 94%	
	ECO Mode	96%	Up to 97%	
Battery & Charger	Battery Voltage	24 Vdc	48 Vdc	72 Vdc
	Battery Type	12V/9 Ah Sealed lead-acid battery		
	Backup Time (Typical) *2	6.5 minutes	7 minutes	
	Charge Current	1.5A	2A	2A
	Recharge Time	3 hours to 90%		
Audible Noise		40 dBA	42 dBA	48 dBA
Display		LED indicators and LCD display		
Communication Interfaces		SMART Slot x 1, RS-232 Port x 1, USB Port x 1, REPO x 1		
Physical	Dimensions (W x D x H)	440 x 335 x 89 mm	440 x 432 x 89 mm	440 x 610 x 89 mm
	Weight	12 Kg	18 Kg	28 Kg
Environment	Operating Altitude	1000 meters (without derating)		
	Operating Temperature	0 ~ 40°C		
	Relative Humidity	5% ~ 95% (non-condensing)		

Delta External Battery Pack (Optional)	1K	2K	3K
Dimension (W x D x H)	440 x 335 x 89 mm	440 x 432 x 89 mm	440 x 610 x 89 mm
Weight	15 Kg	27 Kg	44 Kg
Nominal Voltage	24Vdc	48Vdc	72Vdc
Type	9Ah	9Ah	9Ah



NOTE :

1. *¹ When the UPS is de-rated to 90% of its capacity.
2. *² When the total load reaches 75%.
3. Refer to the rating label for the safety rating.
4. All specifications are subject to change without prior notice.

Appendix 2 : Warranty

Seller warrants this product, if used in accordance with all applicable instructions, to be free from original defects in material and workmanship within the warranty period. If the product has any failure problem within the warranty period, Seller will repair or replace the product at its sole discretion according to the failure situation.

This warranty does not apply to normal wear or to damage resulting from improper installation, operation, usage, maintenance or irresistible force (i.e. war, fire, natural disaster, etc.), and this warranty also expressly excludes all incidental and consequential damages.

Maintenance service for a fee is provided for any damage out of the warranty period. If any maintenance is required, please directly contact the supplier or Seller.



WARNING!

The individual user should take care to determine prior to use whether the environment and the load characteristic are suitable, adequate or safe for the installation and the usage of this product. The User Manual must be carefully followed. Seller makes no representation or warranty as to the suitability or fitness of this product for any specific application.

