

The power behind competitiveness

Delta Infrasuite Power Management

Power Distribution Cabinet

User Manual

www.deltapowersolutions.com



DELTA
Smarter. Greener. Together.

Overview

This document provides the product introduction, component introduction and system maintenance of the DC power system. The pictures in this article are for reference only, and the actual structure shall prevail.

Suitable for

This document (this guide) is primarily intended for the following engineers:

- Sales Engineer
- Technical Support Engineer
- Maintenance Engineer





Safety rules

Before starting the operation, please read the operation instructions and precautions carefully to reduce the occurrence of accidents. The "CAUTION, NOTICE, WARNING, DANGER" items in the product and product manual do not represent all the safety precautions to be followed, but only serve as a supplement to various operational safety precautions. Therefore, the personnel responsible for the installation and operation of this product must be strictly trained and master the correct operation method of the system and various safety precautions before operating the equipment.

When operating the company's products and equipment, user must abide by the safety regulations of the relevant industry, and strictly abide by the relevant equipment precautions and special safety instructions provided by the company.

Notation convention

The following symbols may appear in this article, and their meanings are as follows:

 高压 High Voltage	The AC input line is a high-voltage working line. During the operation, it must be ensured that the AC input is powered off. During the operation, a temporary prohibition sign should be added to the switch that is not allowed to be used.
 危险 Danger	Indicates an imminently hazardous situation which, if not avoided, will result in death or serious personal injury.
 小心 Caution	Indicates a potentially hazardous situation which, if not avoided, could result in moderate or minor personal injury.
 注意 Notice	Used to convey equipment or environmental safety warnings, which, if not avoided, may result in equipment damage, data loss, reduced equipment performance, or other unpredictable results. "NOTICE" does not refer to personal injury.
 说明 Instruction	Used to highlight important/critical information, best practices, tips, etc. "Instructions" are not safety warning information, and do not involve personal, equipment and environmental damage information.

Revision history

Document version 1.0[2022-03-25]

The first official release

Table of Content

Chapter One Preface	5
1.1 General Safety Precautions	5
1.2 Electrical Safety	5
1.3 Mechanical Safety	6
Chapter Two Product introduction	7
2.1 Product Overview	7
2.2 Working principles	7
2.3 System Configuration	8
2.4 Parts Introduction	8
2.4.1 Structure function	8
2.4.2 Monitoring function	9
2.5 Specifications	10
2.5.1 Environmental Indicators	10
2.5.1 Electrical index	10
2.6.1 Mechanical index	10
Chapter Three System Installation	11
3.1 Installation Requirements	11
3.1.1 Construction Personnel Requirements	11
3.1.2 Installation Tool Requirements	11
3.1.3 Cable laying Requirements	12
3.2 Install the power distribution cabinet	12
3.2.1 Planning the installation space	12
3.2.2 Unpacking and Acceptance	12
3.2.3 Install the power distribution cabinet	12
3.3 Install the cable	13
3.3.1 Install the protective ground wire	13
3.3.2 Install Communication Cables	14
3.3.3 Install the output cable	14
3.3.4 Installing the AC Input Cable	15
3.4 Installation Check	15
3.4.1 Check Hardware Installation	15
3.4.2 Check electrical connections	15
3.4.3 Check cable installation	16
Chapter Four System Commissioning	17
4.1 AC power-on debugging	17
4.2 View system parameters	17
4.3 Other processing	17
Chapter Five System Maintenance	18

- 5.1 Routine Maintenance18**
- 5.2 Alarm Troubleshooting18**
 - 5.2.1. SPD Fault 18
 - 5.2.2. Main circuit switch status display open 18
 - 5.2.3. Shunt switch status display open 18
 - 5.2.4. AC overvoltage 19
 - 5.2.5. AC undervoltage 19
 - 5.2.6. HMI Communication with the host is abnormal 19
- 5.3 Component fault location19**
 - 5.3.1. Air switch fault location 19
 - 5.3.2. Monitoring module fault location 19

Chapter 1 Preface

1.1 General Safety Considerations

- This product should be used in an environment that meets the design specifications, otherwise it may cause product failure, resulting in abnormal product function or component damage, which is not within the scope of product quality assurance.
- The personnel responsible for installing and maintaining the equipment must first undergo strict training, understand various safety precautions, and master the correct operation methods before installing, operating and maintaining the equipment.
- Operators should follow local regulations and codes. The safety precautions in the manual are intended only as a supplement to local safety regulations.
- Operation of equipment and cables during thunderstorms is prohibited.
- It is strictly forbidden to wear watches, bracelets, bracelets, rings and other conductive objects on the wrist during operation.
- Special insulated tools must be used during operation.
- Installation or maintenance operations must follow the sequence of steps in the task.
- Before touching any conductor surface or terminal, measure the voltage at the point of contact with an electricity meter to confirm that the point of contact is free or within a predicted range.
- If the battery is not connected to the power system or the battery capacity is insufficient, the load (electric equipment) may be powered off during maintenance or fault location.
- More than 24 hours before the laying operation.
- After the installation of the equipment is completed, the user should carry out routine inspection and maintenance of the equipment in accordance with the requirements of the user manual, and replace the faulty parts in time to ensure the safe operation of the equipment.

1.2 Electrical Safety

Ground safety

- When installing the device, the protective ground wire must be installed first; when removing the device, the protective ground wire must be removed last.
- Before operating the equipment, make sure that the equipment is properly grounded.

AC and DC operation requirements



The supply voltage of the power supply system is dangerous, and direct contact or indirect contact through wet objects with these parts will bring fatal danger. Irregular and incorrect operation may cause accidents such as fire or electric shock.

- The installation of AC power equipment must comply with the safety regulations of the relevant industry, and the personnel who install the AC equipment must be qualified for high-voltage and AC power operations.
- Before the equipment is electrically connected, the pre-protection switch of the equipment must be disconnected.
- Before connecting to AC power, you must ensure that the electrical connections to the equipment are

complete.

- Before connecting the load (power equipment) cable or battery cable, you must confirm the polarities of the cables and terminals to prevent reverse connection.
- It is strictly forbidden to wear watches, bracelets, bracelets, rings and other conductive objects on the wrist during operation.
- Prohibition signs must be hung on switches and buttons that cannot be operated during installation.

Anti-static requirements

- In order to prevent human body static electricity from damaging sensitive components, you must wear anti-static gloves or ESD gloves before touching the circuit board.
- An anti-static wrist strap, and the other end of the anti-static wrist strap is well grounded.
- When holding a veneer, you must hold the edge of the veneer that does not contain components, and it is forbidden to touch the chip with your hands.
- The disassembled veneer must be packed with anti-static packaging material before storage or transportation.

Liquid resistance requirements

- This product should be placed in an area away from liquids, and it is forbidden to install it below the air-conditioning vents, vents, outlet windows of the equipment room and other places prone to water leakage, to prevent liquid from entering the equipment and cause a short circuit, and to ensure that there is no condensation in the equipment room and equipment.
- When you find that liquid has entered the inside of the device, please turn off the power immediately and notify the administrator.

1.3 Mechanical safety

Lifting safety

- Personnel who carry out hoisting operations need to undergo relevant training and can only take up their posts after being qualified.
- Lifting tools need to be inspected and the tools are complete before they can be used.
- Before hoisting work, make sure that the hoisting tool is securely fastened to a load-bearing fixture or wall.
- During the hoisting process, ensure that the angle between the two cables is not greater than 90°.

Safe use of ladders

- Before using the ladder, make sure that the ladder is in good condition. And confirm the size of the load-bearing weight specified by the ladder, and prohibit the use of excessive weight.
- Figure 1-1, the inclination of the ladder is preferably 75°, which can be measured with a square or arm. Ladders should be used with the wide feet facing down or with protection at the bottom of the ladder to prevent the ladder from falling. Ladders should be placed in a stable place.

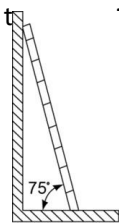



Figure 1-1 Schematic diagram of the inclination of the ladder

- When carrying heavy objects, be prepared to bear the weight to avoid being crushed or sprained by heavy objects.
- When handling the device by hand, wear protective gloves to avoid cutting your hands from sharp corners.

Drilling Safety

 注意 Notice	Do not drill holes in the cabinet by yourself. Drilling holes that do not meet the requirements will destroy the electromagnetic shielding performance of the cabinet and damage the internal cables. Metal chips generated by the drilling will
---	--

- Before drilling holes in the cabinet, remove the cables inside the cabinet.
- Goggles and protective gloves should be worn when drilling.
- Strictly prevent metal shavings from falling into the cabinet, and clean up the metal shavings in time after drilling.

Chapter 2 Product Introduction

2.1 Product description

Power distribution cabinet system, is to give 220V AC or 380V AC series equipment is used for power supply, the maximum output current is 400A, and it is divided into 51 outputs. The appearance of the product is shown in Figure 2-1.

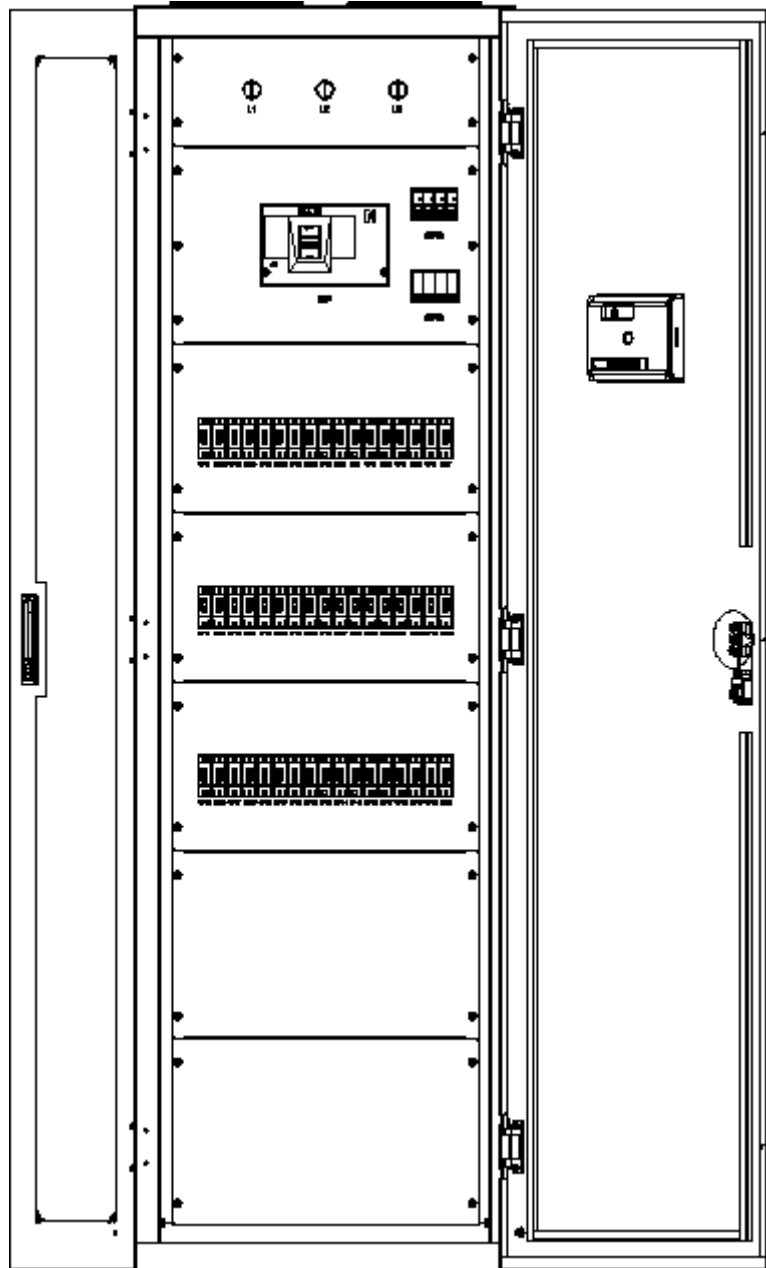

Figure 2-1 Product Appearance

2.2 Working principle

Schematic diagram of the working principle of the power distribution cabinet system is shown in Figure 2-2. The AC power passes through the main molded case circuit breaker, passes through the main transformer, the 51 -way sub-transformer, and then reaches the 51 -way miniature circuit breaker to supply power to multiple loads.

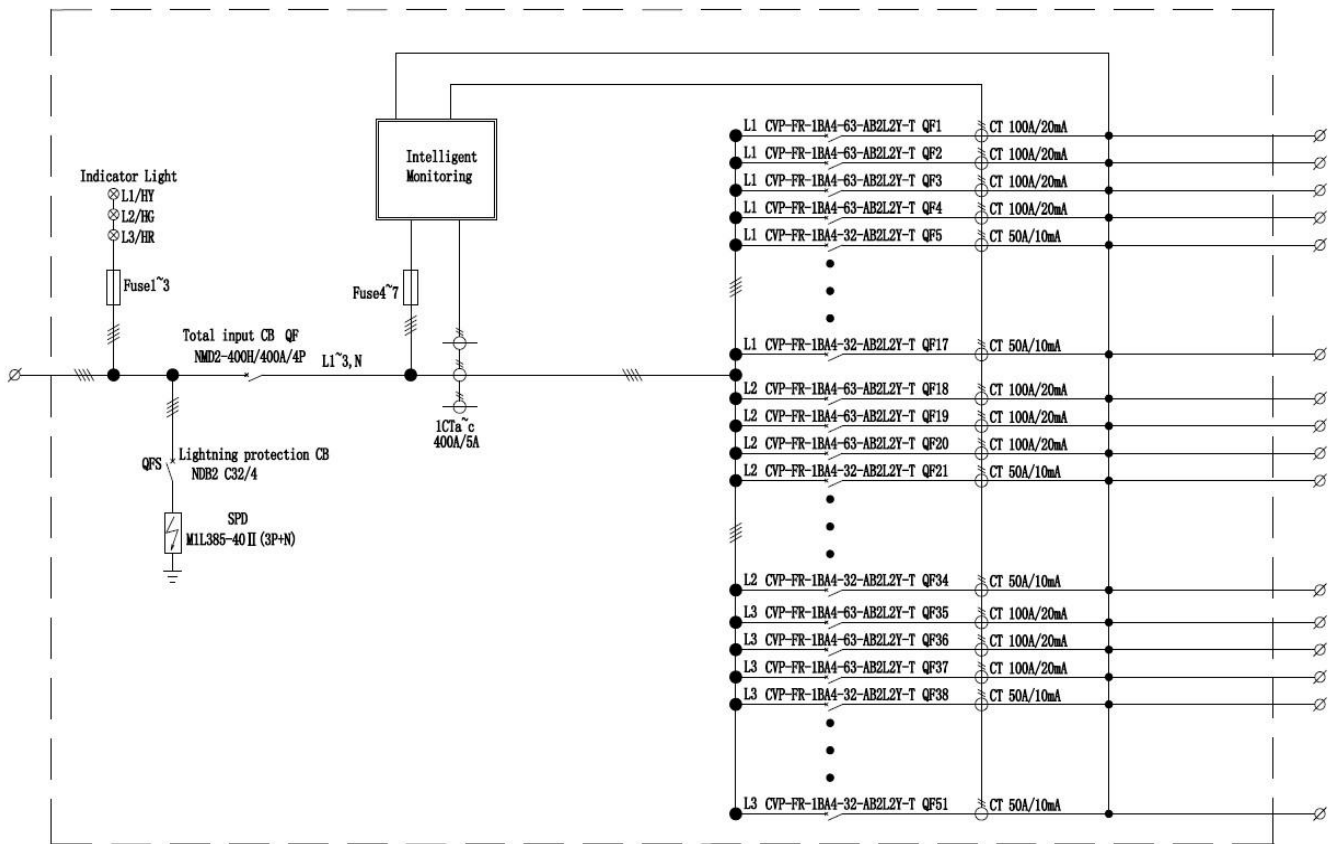

Figure 2-2 Schematic diagram of the working principle of the system

2.1 System Configuration

The system configuration is shown in Table 2-1.

Project	System configuration
Monitoring unit	YD-DEMS-BD2-N YM- DEMS-BD11Q24YM- DEMS-BD11Q30 YDE-DD150-1212
Molded case circuit breaker	NDM2-400L/4300B400
Magnetic circuit breaker	SPEC(CVP-FR-1BA4-32-AB2L2Y-T)*41 SPEC(CVP-FR-1BA4-63-AB2L2Y-T)*10
Lightning protection circuit breaker	NDB1-63C32/4
AC lightning protection	In(8/20us): 20KA; I _{max} (8/20us): 40KA , Class C

Table 2-1 System configuration

2.2 Parts Introduction

2.2.1 Structure function

System structure and functions are shown in Figure 2-3.

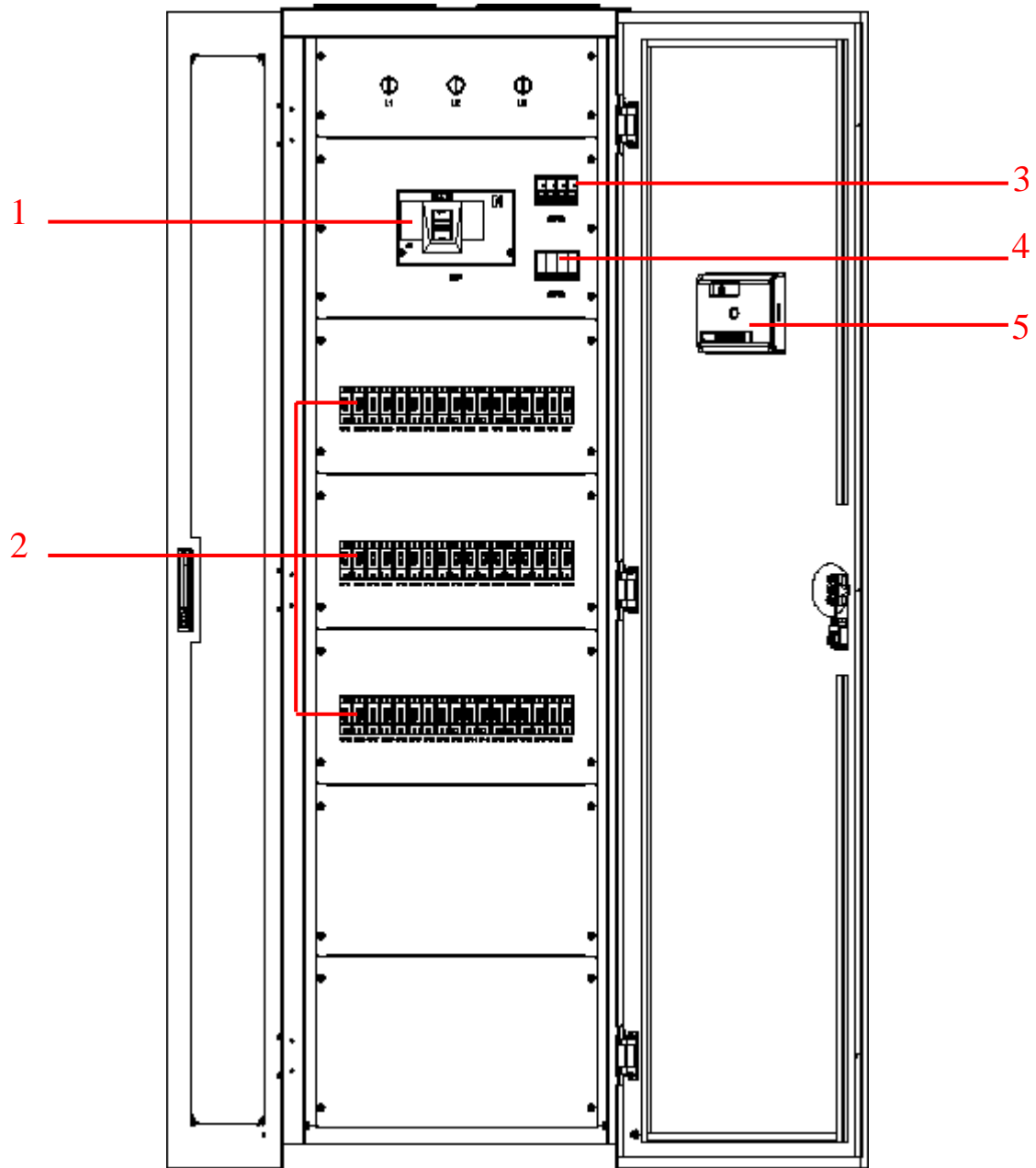

Figure 2-3 System structure and function

- (1) Input molded case circuit breaker
- (2) Output magnetic circuit breaker
- (3) Lightning protection circuit breaker
- (4) Lightning protection
- (5) Monitoring unit

2.2.2 Monitoring function

For the function description of the system, see YD-DEMS-VD2-DC - The user manual of touch screen operation



YD-DEMS-VD2-DC-
The user manual o

2.3 Technical indicators

2.3.1 Environmental indicators

Table 2-2 Environmental indicators

parameter name	Parameter Description
Operating temperature	-40°C ~ + 65°C
transport temperature	-40°C ~ + 70°C
Storage temperature	-40°C ~ + 70°C
Working humidity	5%RH ~ 95%RH, no condensation
Storage humidity	5%RH ~ 95%RH, no condensation
Altitude requirements	0 ~ 4000m (in the environment of 3000m ~ 4000m high temperature derating, every 200m rise , the working temperature decreased by 1°C)

2.5.1 Electrical Specifications

Table 2-3 Electrical Specification

parameter name	Parameter Description	
AC input	input format	TT and TN and their subsystems, line voltage 380Vac
	input frequency	50Hz (45Hz ~ 65Hz); nominal frequency: 50Hz/60Hz
	input capacity	400A
AC output	The output voltage	220Vac
	output capacity	32A*41 63A*10

other	Safety design	Meet the standard IEC/EN60950-1/GB 4943
	Insulation resistance	After removing the monitoring module, rectifier module, and lightning protection module, the connection between the DC part, the AC part and the chassis is Insulation resistance > 10MΩ (Test voltage 500Vdc)
	Dielectric strength	To the AC input and DC output parts; apply 1500VAC to the AC part and the case; apply 500VAC to the DC output and the case. No breakdown arcing and leakage in one minute flow ≤ 10mA.

2.6.1 Mechanical index

Table 2-4 Electrical Specifications

parameter name		Parameter Description
structure	Power System (H×W×D)	2000±2mm×600±2mm×1200±2mm
	weight	≤ 50kg
	Protection class	IP20
	Installation method	Floor installation
	In and out way	top-in, top-out
	Maintenance method	Pre-support maintenance method
	Cooling method	Natural heat dissipation

Chapter 3 System Installation

This chapter describes the installation requirements, installation, wiring, and installation inspection of the power system.

3.1 Installation requirements

3.1.1 Construction personnel requirements

Construction personnel must have basic knowledge of safe operation, undergo professional training, master correct operation methods, and have corresponding operating qualifications.

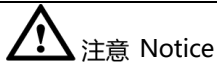

注意 Notice

The company does not assume any responsibility for the damage to individuals and equipment caused by the construction personnel not operating in accordance with the requirements of this article!

Customers should pay attention to the following points when organizing construction personnel:

- The technical personnel of the client side should undergo relevant training and master certain installation and construction methods.
- The number of construction personnel should be determined according to the specific project schedule and installation environment, generally 2 to 4 people are appropriate.

3.1.2 Installation tool requirements

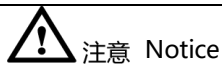















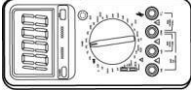







注意 Notice

Use tools with insulated handles!

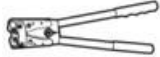
Introduce the tools and instruments that need to be prepared before installation (including but not limited to the tools in the table below).

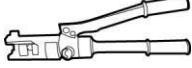
Table 3-1 Preparation tools and instruments

List of tools and meters				
Torque batch 	marker pen 	Clamp Ammeter 	utility knife 	heat gun 
Claw Hammer 	Insulated adjustable wrench 	multimeter 	Flat-blade screwdriver 	Phillips screwdriver 
ruler 	Insulated torque wrench 	cable tie 	wire cutters 	Insulated Gloves 

<p>Insulation Tape</p> 	<p>combination wrench</p> 	<p>Thermal casing</p> 	<p>Crimping Tool</p> 	<p>Insulated protective shoes</p> 
<p>hydraulic pliers</p> 	<p>Diagonal pliers</p> 	<p>wire stripper</p> 	<p>tape measure</p> 	<p>Anti-static wrist</p> 

3.1.1 Cable laying requirements

- Cables should be kept 20mm away from heat sources to prevent insulation damage (melting) or functional degradation (aging or breakage).
- The bend radius of the cable should be at least five times the diameter of the cable.
- Cables of the same type should be connected together, with a minimum distance of 30mm between cables of different types to avoid entanglement.
- The cables connected together should be close to each other, neat and undamaged.
- The ground wire should not be connected or tangled with the signal cable, and there should be an appropriate distance between them to minimize interference.
- AC power cords, DC power cords, signal cables, and communication cables must be connected separately.
- No soldering or soldering should be done on the power cord, use longer cables if necessary.

3.2 Install the power distribution cabinet

3.2.1 Planning the installation space

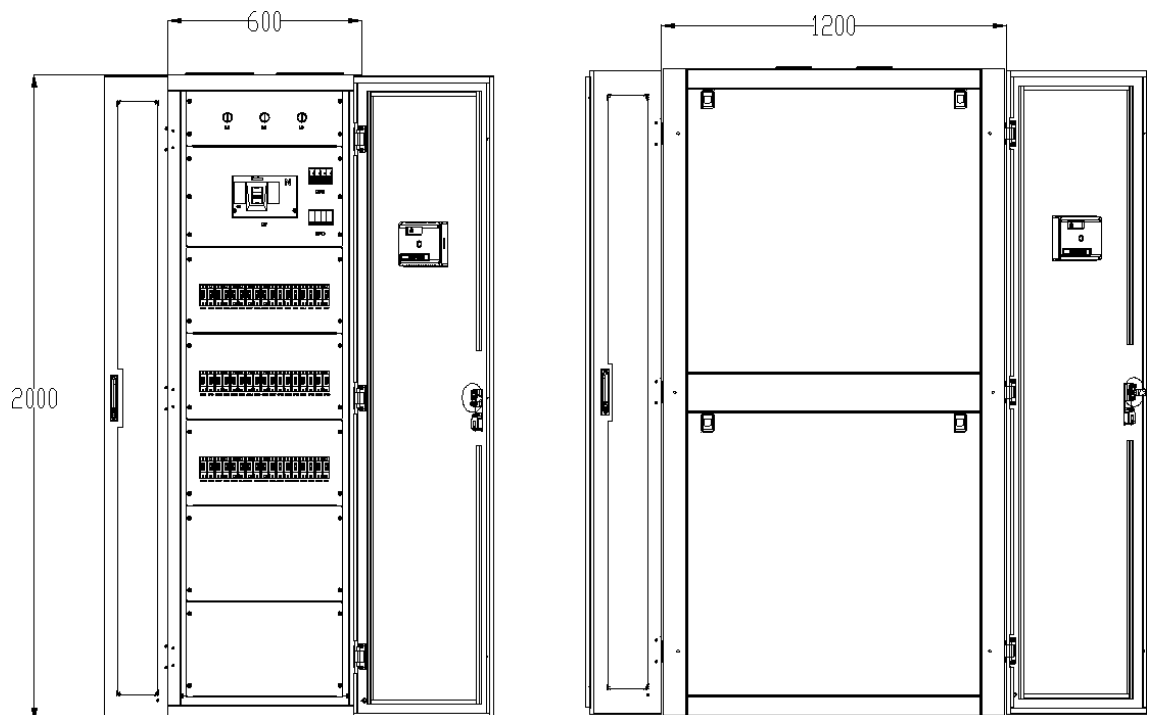

Figure 3-1 Dimensions

3.2.2 Unpacking and acceptance

- Step 1, check if the box is intact.
If the box is badly damaged or wet, please find out the reason and give us feedback.
- Step 2, open the box.
- Step 3, check the number of parts on the packing list.
If the quantity is different from the quantity on the packing list, please confirm the reason and give us feedback.

3.2.3 Install the power distribution cabinet

Install the power distribution cabinet on the ground or a concrete base, as shown in Figure 3-2.

- Step 1. Remove the power distribution cabinet from its packaging.
- Step 2, align the installation holes of the power distribution cabinet and put them into the ground studs.
- Step 3, install the fixing screws.

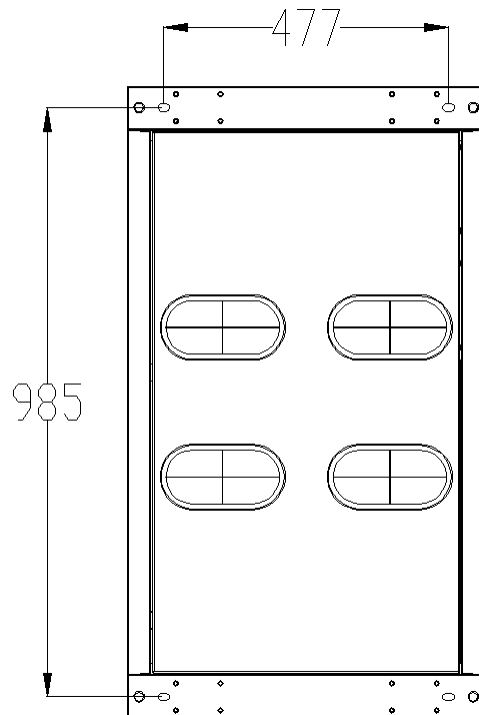
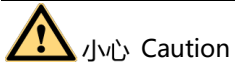

Figure 3-2 Mounting holes

3.3 Install the cable

3.3.1 Install the protective ground wire



Make sure the ground wire is connected reliably. Equipment damage or personal injury may result if equipment is not properly grounded.

- Step 1. Connect one end of the protective ground wire to the PE terminal block of the AC input.
- Step 2. Connect the other end of the protective ground wire to the main grounding bar screw in the equipment room, as shown in Figure 3-3. No. 1 is the grounding bar.

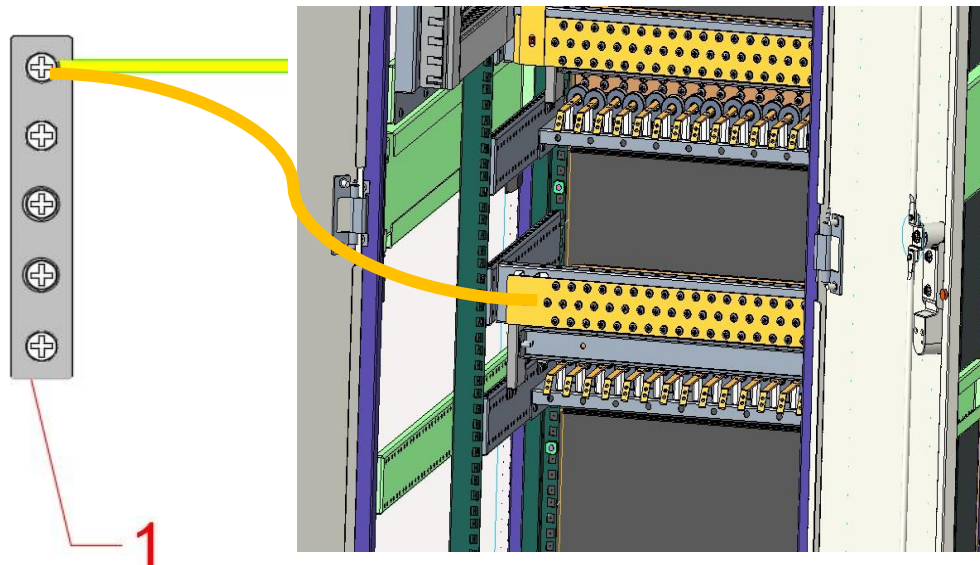

(1) Ground bar

Figure 3-3 Installing the protective ground wire

3.3.2 Install communication cables

- Step 1. Connect one end of the cable to the RS485 port of the monitoring module.
- Step 2. Connect the other end of the cable to the network port of the host computer, as shown in Figure 3-10.

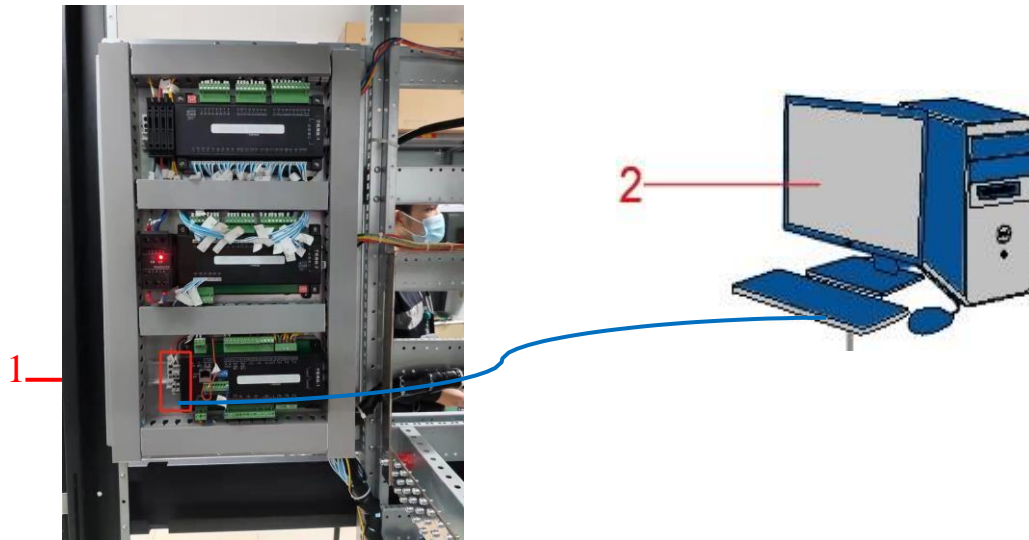

(1) RS485 interface of the system (2) Host computer

Figure 3-4 Schematic diagram of communication cable connection

3.3.3 Install the output cable



1. Please make sure that the AC output air switch of the front stage is in the OFF state, and place a prominent sign of "prohibited operation".
2. Turn off all air switches before installing cables.

- Step 1, place 220 The AC single-phase three-wire AC output cables are routed through the top or bottom of the power distribution cabinet.
- Step 2, according to the actual load capacity, fasten the output L cable to the output air switch copper bar of the corresponding specification.
- Step 3. Fasten the output N cables to the screws corresponding to the specifications of the zero row.

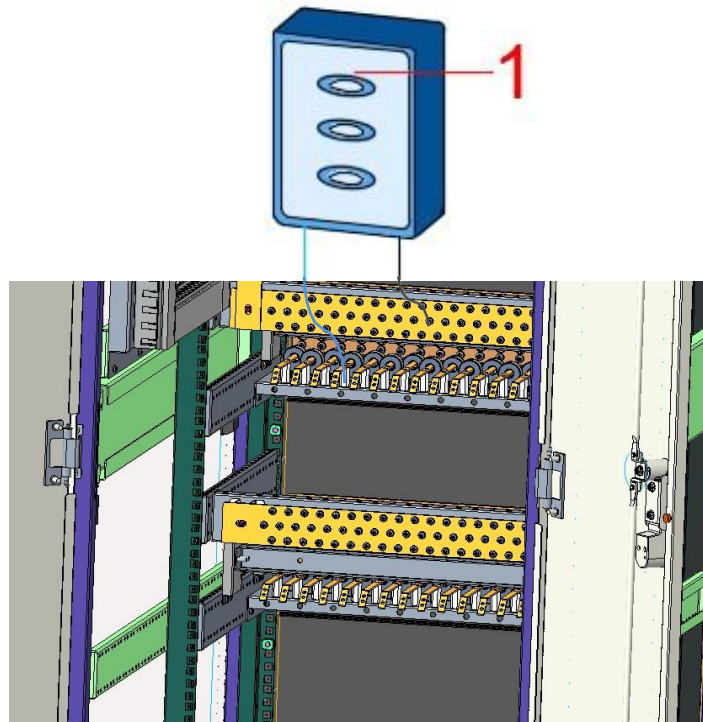

(1) AC load

Figure 3-4 Output cable wiring diagram

3.3.4 Installing the AC Input Cable



危险

Danger

1. Please ensure that the front-end AC input air switch is in the OFF state, and place a prominent sign of "prohibited operation".
2. Turn off all air switches before installing cables.

- Step 1, put the 220/380V Pass the AC three-phase four-wire AC input cable from the rear side of the sub-rack and remove the front top cover for wiring.
- Step 2. Fasten the AC input cable to the corresponding AC input terminal, as shown in Figure 3-13.

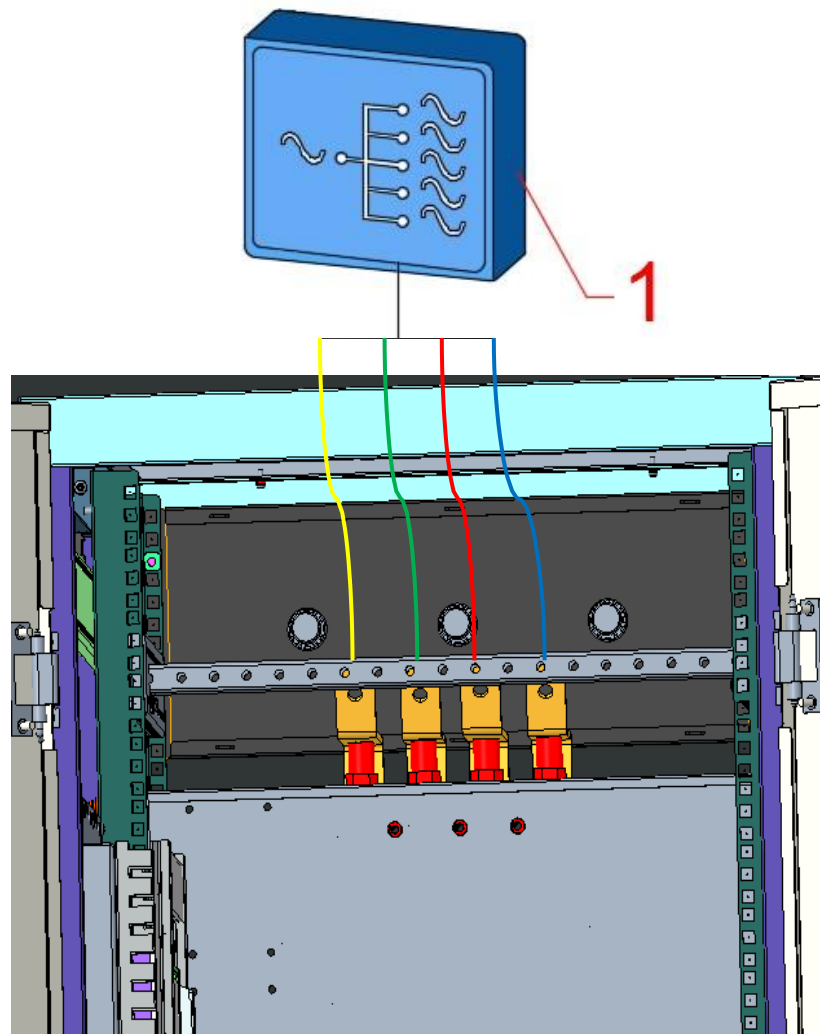

(1) AC input

Figure 3-5 Wiring diagram of AC input cable

3.4 Installation check

3.1.1 Check hardware installation

- Check that all screws are tight (especially those used for electrical connections) and check that flat washers and spring washers are installed correctly.
- Check that the rectifier module is fully inserted into each slot and locked correctly.

3.1.2 Check electrical connections

- Check that all air switches are OFF.
- Check that flat washers and spring washers are securely installed on all terminals and that all

OT terminals are intact and properly connected together.

- Check that the input and output power cables and ground cables are properly connected.

3.1.3 Check cable installation

- Check that all cables are securely connected.
- Check that all cables are neatly lined up and connected tightly to their nearest cables without twisting or over-bending.
- Check that the cable labels are correct, firm, and oriented in the same direction.

Chapter 4 System Commissioning



注意 Notice

- The following commissioning steps may cause power failure or generate alarms. You need to notify the alarm center before and after the operation is completed.
- Commissioning personnel must undergo corresponding technical training, and be sure to refer to the commissioning instructions.
- The commissioning process is a live operation. Please stand on a dry insulating material during operation. Do not wear metal objects such as watches and necklaces. Tools should be insulated.
- During equipment commissioning, be sure to check whether the status of related units or components meets the requirements before any "closing operation".
- During the operation, if other people are not allowed to operate, a prohibition sign should be hung on the power distribution equipment: "It is forbidden to close the switch, and someone will operate it".
- In the process of commissioning, you should observe while commissioning, and immediately shut down if any abnormality is found, and continue after the cause is identified.

3.2 AC power-on debugging

- 3.2.1 Step 1. Measure the input voltage of the AC input circuit breaker, which should be between $380V \pm 10\%$ AC.
- 3.2.2 Step 2, turn the AC input circuit breaker ON, and measure the output voltage of the AC input circuit breaker, which should be between $220V \pm 10\%$ AC.
- 3.2.3 Step 3, check the running indicator (yellow, green, red) it should be always on.
- 3.2.4 Step 4, the monitoring display is normal, and the voltage parameters are correct.

3.3 View system parameters



说明

Instruction

For the function description of the system, see YD-DEMS-VD2-DC - The user manual of touch screen operation



YD-DEMS-VD2-DC-
The user manual o

- 3.3.1 Step 1. Click "System Diagram" on the main screen to enter the system diagram screen,

and check the SPD status, the status of the main circuit switch and the status of each branch switch.

- 3.3.2 Step 2, click "Data View" to enter the incoming line data screen, click "Basic Electrical Parameters" on the incoming line data screen to check the incoming line voltage.
- 3.3.3 Step 3, click "Data View" to enter the incoming line data screen, click "Power Data Record" on the incoming line data screen.
- 3.3.4 Step 4: On the incoming line data screen, click the "Feeder" bar box on the left side of the screen to enter the feeder data screen and click the data item to view the parameters.
- 3.3.5 Step 5. Click "Alarm/Event" to enter the alarm record screen, and click the bar box of "Real-time Alarm", "Historical Alarm", "Operation Record", "Power Record", "Incoming Line Record", and "Feeder Record". Switch the screen.

3.4 Other processing

- 3.4.1 Put the removed panel or cover back in place.
- 3.4.2 The exterior paint should be kept intact. If the paint is peeled off, the paint should be repainted immediately to prevent corrosion.
- 3.4.3 Clean up the site, exit the site.

Chapter 5 System Maintenance

5.1 Routine maintenance

Table 5-1 Daily maintenance list

maintenance item	Maintenance content			
	Check items	Inspection Method	Repair condition	Approach
Electric	Is the voltage output normal?	multimeter	The main circuit or load branch voltage exceeds the set range	See 5.2 Alarm
Troubleshooting	Is the indicator light normal?	Visual inspection	There is a fault alarm	Troubleshooting
Exterior	No peeling or scratching of the system coating	Visual inspection	Damaged or deformed appearance of the system	Repaint, repair the shell
Ground detection	Is the grounding point of the power distribution cabinet connected to the grounding bar of the equipment room?	Visual inspection, screwdriver, wrench and other tools	Check that the cable connection between the grounding point of the power distribution cabinet and the grounding row of the equipment room is unreliable	Re-tighten the grounding point or replace the grounding cable

5.2 Alarm Troubleshooting

5.2.1. SPD failure

Possible Causes:

1. Damaged SPD.
2. The SPD detects that the signal cable is disconnected.

Approach:

1. Check the SPD trip window, if it is red, the SPD needs to be replaced.
2. Check whether the signal detection cable is loose, and if so, fix the cable.

5.2.2. Main circuit switch status display open

Possible Causes:

1. The main molded case circuit breaker is not closed.
2. The SPD detects that the signal cable is disconnected.

Approach:

1. Check if the molded case switch is open, if so, close the molded case switch.
2. Check whether the signal detection cable is loose, and if so, fix the cable.

5.2.3. Shunt switch status display open

Possible Causes:

1. Each branch MCB is not closed.
2. The state collection line of each shunt switch falls off.

Approach:

1. Check whether the corresponding miniature circuit breaker is open, if so, close the corresponding miniature circuit breaker.
2. Check whether the corresponding branch signal detection cable is loose, and if so, fix the cable.

5.2.4. Shunt switch status display open

Possible Causes:

1. The setting of the AC overvoltage alarm point is unreasonable.
2. Grid failure.

Approach:

1. Check if the AC input cable is loose, if so, fix the input cable. Check whether the AC overvoltage alarm setting value is reasonable. If not, adjust it according to the actual situation.
2. Check whether the AC input voltage of the power system exceeds the "AC overvoltage alarm point", and if so, handle the AC input fault.

5.2.5. AC under-voltage

Possible Causes:

1. The AC under-voltage alarm point setting is unreasonable.
2. Grid failure.

Approach:

1. Check whether the AC under-voltage alarm setting value is reasonable. If not, adjust it according to the actual situation.
2. Check whether the AC input voltage of the power system is lower than the "AC under-voltage alarm point", and if so, handle the AC input fault.

5.2.6. HMI and host

Possible Causes:

1. The communication cable is disconnected.
2. Device address dialing error.

Approach:

1. Check if the communication cable is loose, if so, fix the cable.
2. Check whether the device dialing code is correct, if so, redial the dialing code.

5.3 Component fault location

5.3.1. Air switch fault location

Air switch failures mainly include the following phenomena:

- After dealing with the short circuit fault of the rear end of the air circuit breaker, the ON/OFF adjustment of the air circuit breaker cannot be performed.
- The voltage at the input terminal of the air switch is normal and in the ON state, the voltage across the air switch is greater than 1V.
- The voltage at the input terminal of the air switch is normal and in the OFF state, the resistance value at both ends of the air switch is less than 1kΩ.

5.3.2. Monitoring module fault location

The faults of the monitoring module mainly include the following phenomena:

- The monitoring module has obvious faults, such as: crash, no response when booting, LCD display problems, buttons cannot be operated, etc.
- When the alarm is enabled, the monitoring module does not generate an alarm when the power system fails.
- After the monitoring module generates an alarm, it is detected that the power system does not have the fault indicated by the alarm.
- When the communication line is normal, all subordinate devices displayed in the monitoring module are interrupted in communication.
- When the rectifier module and the communication line are normal, the communication between the monitoring module and all rectifier modules is interrupted.
- The monitoring module cannot set parameters or view running information.

