

Metered iPDU User Manual (Delta P/N: AD-240/32P-A)

28.8kVA, 3-Phase WYE/Delta/Single connection

Table of contents

1	GENERAL	4
1.1	SAFETY PRECAUTIONS	4
1.2	SAFETY INSTRUCTIONS.....	6
1.2.1	<i>General Instructions.....</i>	6
1.3	RACK MOUNT INSTRUCTIONS	8
	PDU SPECIFICATIONS	9
1.4	UNIVERSAL 0U IPDU – OUTWARD AND DIMENSION.....	10
1.5	3-PHASE DELTA – WIRING DIAGRAM.....	10
1.6	3-PHASE WYE– WIRING DIAGRAM	11
1.7	SINGLE PHASE – WIRING DIAGRAM.....	11
1.8	COMMUNICATION MODULE INTERFACE	12
2	STARTUP.....	13
3	INSTALLATION	14
4	MANAGEMENT	23
4.1	WEB ACCESS	23
4.2	SERIAL PORT.....	24
4.3	SERIAL CONSOLE TO UPGRADE FIRMWARE	28
5	ENVIRONMENTAL.....	32
5.1	TEMPERATURE	32
	<i>OPERATING (please ref dec 108000336).....</i>	32
	<i>HIGH Temperature Test.....</i>	32
5.2	HUMIDITY	32
	<i>OPERATING</i>	32
5.3	ALTITUDE	32
	<i>OPERATING</i>	32

Change History

Rev.	Date	Description	Prepared by	Approval
1.0	2021/Jun./11	First draft.	Fiona Chen Omar Lin Emily Wang	Carol Li
2.0	2021/Nov./23	Update customer requirement. Add PDU 2. Startup chapter	Fiona Chen Emily Wang	Carol Li
3.0	2022/Jun./13	Update 1. General	Fiona Chen Emily Wang	Carol Li
4.0	2022/Oct/31	Page 6: Remove Dell P/N & Add PDP Page 7: Remove Dell P/N & Add PDP Page 16: Add EMP Installation Page 20: PDP Input Connection Page 27: Add 4.3 Serial Console to Upgrade Firmware	Fiona Chen	Carol Li
5.0	2023/Nov/10	Replace DellEMC logo to Dell Update PDP outward Update Web browser interface screenshot	Omar Lin Emily Wang Euguen Huang	Carol Li
6.0	2024/Mar/14	Page 16 and 22 :Add Caution about latch	Omar Lin	Carol Li
7.0	2024/Sep/4	Page 23: Update Web browser interface screenshot	Euguen Huang	Carol Li

1 General

1.1 Safety Precautions

1. Disconnect power before servicing (not hot-swappable)

The PDU/iPDP shall be service by “Skilled Persons” only at the end user or customer site (data center). The PDU/PDP are not hot-swappable units, so it must disconnect main power before servicing (Plugging or removing) input power cord with Anderson connector to the PDU/PDP.

2. External overcurrent protective device rating (PDU/PDP/iRM)

The short-circuit backup protection device is considered to be provided external to the equipment, a circuit breaker with adequate breaking (rupturing) capacity to interrupt the maximum fault current is provided between the equipment and the building installation. External circuit breaker rating as below:

<i>Model</i>	<i>Supply type</i>	<i>Rating of external circuit breaker</i>
PDP-D040A-A, PDP-D040A-B	3-Phase, Delta connection (3W+PE)	50A
PDP-C024A-A, PDP-C024A-B	3-Phase, WYE connection (3W+N+PE)	30A
PDP-A024A-A, PDP-A024A-B	3 Input-Single phase	30A

3. Power cord information

Use only with UL Listed Power Supply Cord as details below.

No.	Dell /EMC Part Number	Description	Jacket Color	Spec	Plug	Cord Type	APP	Used Region	UL 817	Rating
1	038-004-222	24A Single-Phase Titan-D PDU Power Cord, N. America, Japan	Black	Y	NEMA L6-30P	10AWG, 3-Conductors, SJOOW, 300V	S	NA	Y	24A / 250VAC
2	038-004-293	PWR CORD 24A SP 15FT L6-30P	Gray	Y	NEMA L6-30P	SJOOW 3 x 10 AWG 300V	S	NA	Y	24A / 250VAC
3	038-004-774	24A Single-Phase Titan-D PDU Power Cord, International	Black	Y	IEC 309 3P	3x6mm2, <HAR> H07RN-F, outer jacket black	S	EU		24A / 250VAC
4	038-004-775	PWR CORD 24A SP 15FT IEC309P GRAY 4PPP	Gray	Y	IEC 309 3P	3x6mm2, <HAR> H07RN-F, outer jacket black	S	EU		24A / 250VAC
5	038-004-776	24A Single-Phase Titan-D PDU Power Cord, Australia	Black	Y	Clipsal 56PA332	3x6mm2, <HAR> H07RN-F, outer jacket black	S	Australia		24A / 250VAC
6	038-004-777	PWR CORD 24A SP 15FT 56PA332 GRAY 4PPP	Gray	Y	Clipsal 56PA332	3x6mm2, <HAR> H07RN-F, outer jacket black	S	Australia		24A / 250VAC
7	038-004-228	24A Single-Phase Titan-D PDU Power Cord, N. America, Japan	Black	Y	RussellStoll 3750DP	10AWG, 3-Conductors, SJOOW, 300V	S	NA	Y	24A / 250VAC
8	038-004-296	PWR CORD 24A SP 15FT 3750DP GRAY 4PPP	Gray	Y	RussellStoll 3750DP	10AWG, 3-Conductors, SJOOW, 300V	S	NA	Y	24A / 250VAC
11	038-004-431	3-Phase DELTA Titan-D PDU Power Cord, N. America	Black	Y	CS 8365C	8AWG, 4-Conductors, Type W, Black	D	NA	Y	40A / 250VAC
12	038-004-432	3-Phase DELTA Titan-D PDU Power Cord Gray, N. America	Gray	Y	CS 8365C	8AWG, 4-Conductors, Type W, Black	D	NA	Y	40A / 250VAC
13	038-004-433	3-Phase DELTA Titan-D PDU Power Cord, BLK, N. America	Black	Y	Russellstoll 9P54U2T/1100	8AWG, 4-Conductors, Type W, Black	D	NA	Y	40A / 250VAC
14	038-004-434	3-Phase DELTA Titan-D PDU Power Cord Gray, N. America	Gray	Y	Russellstoll 9P54U2T/1100	8AWG, 4-Conductors, Type W, Black	D	NA	Y	40A / 250VAC
15	038-004-429	3-Phase DELTA Titan-D PDU Power Cord, BLK, International	Black	Y	Russellstoll 9P54U2T/1100	10mm2, 4-Conductors, Type EURO & BSI, outer jacket Black	D	EU	Y	40A / 250VAC
16	038-004-430	3-Phase DELTA Titan-D PDU Power Cord Gray, International	Gray	Y	Russellstoll 9P54U2T/1100	10mm2, 4-Conductors, Type EURO & BSI, outer jacket Black	D	EU	Y	40A / 250VAC
19	038-004-778	3-Phase WYE Titan-D PDU Power Cords, BLK, International	Black	Y	IEC 309 5P	6mm2, 5-Conductors, Type <HAR> H07RN-F, outer jacket black	W	EU	Y	24A / 250VAC
20	038-004-779	3-Phase WYE Titan-D PDU Power Cords Gray, International	Gray	Y	IEC 309 5P	6mm2, 5-Conductors, Type <HAR> H07RN-F, outer jacket black	W	EU	Y	24A / 250VAC
21	038-004-862	3 Phase WYE Power cord BLK Worldwide	Black	Y	IEC 309 5P	6mm2 (10AWG), 5 Conductors, SOOW, UL/CSA, <HAR> H07RN-F, outer jacket black	W	WW	Y	24A / 250VAC
22	038-004-863	3 Phase WYE Power cord GRY Worldwide	Gray	Y	IEC 309 5P	6mm2 (10AWG), 5 Conductors, SOOW, UL/CSA, <HAR> H07RN-F, outer jacket black	W	WW	Y	24A / 250VAC
23	038-002-499	3-Phase WYE Titan-D PDU Power Cords, BLK, International	Black	Y	NA, Stripped wires	6mm ² , 5-Conductors, Type OLFLEX cordage with UL/CSA SOOW and Harmonized <HAR> H07RN-F approval, outer jacket Black	W	WW exclude NA		
24	038-002-500	3-Phase WYE Titan-D PDU Power Cords Gray, International	Gray	Y	NA, Stripped wires	6mm ² , 5-Conductors, Type OLFLEX cordage with UL/CSA SOOW and Harmonized <HAR> H07RN-F approval, outer jacket Black	W	WW exclude NA		

1.2 Safety Instructions

Warnings, cautions, and notes are used to identify important information. They are classified as follows:



Warning! A warning means that injury or death is possible if the information or instructions are not obeyed.



Caution! A caution means that damage to equipment is possible if the information or instructions are not obeyed.



Note! Notes are additional information which may be useful to the operator.

1.2.1 General Instructions



Warning! Multiple source

Caution – Shock Hazard. Disconnect all power source

Attention – Risque d'électrocution. Débranchez toutes les sources d'alimentation

Only used for Single Phase

<i>Delta P/N</i>	<i>Parts</i>
PDP-A024A-A	3 Input - Single Phase iPDP
PDP-A024A-B	3 Input - Single Phase Basic PDP

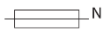

Caution(Attention)! Neutral Fuse  

Double pole, neutral fusing Disconnect mains before servicing.

Double pôle/fusible sur le neutre.



Note! Equipment for use in location where children are not likely to be presented

“This equipment is not suitable for use in locations where children are likely to be present”
(Instruction)

“Cet équipement ne convient pas à une utilisation dans des lieux pouvant accueillir des enfants”
(Instruction)



Caution(Attention)!

Suitable for installation in Information Technology Rooms in accordance with Article 645 of the National Electrical Code and NFPA 75.

Peut être installé dans des salles de matériel de traitement de l’information conformément à l’article 645 du National Electrical Code et à la NFPA 75 (Marking or Instruction)



Caution(Attention)!



Caution - Risk of Electrical/Mechanical Damage

Disconnect plug side of Power Supply Cord before removing iPDP/PDP and Jumper Box.

AC connectors on iPDP/PDP and Jumper Box are accessible to SKILLED PERSONS only, and are located entirely in Service Access Areas only.

The AC mains connector is NOT hot pluggable.

<i>Delta P/N</i>	<i>Parts</i>
PDP-D040A-A	3-Phase Delta iPDP
PDP-C024A-A	3-Phase WYE iPDP
PDP-A024A-A	3 Input - Single Phase iPDP
PDP-J032A-A	Non-Active Jumper Module
PDP-J032A-B	Active Jumper Module

- Basic PDP Type

<i>Delta P/N</i>	<i>Parts</i>
PDP-D040A-B	3-Phase Delta Basic iPDP
PDP-C024A-B	3-Phase WYE Basic PDP
PDP-A024A-B	3 Input - Single Phase Basic PDP

**Warning! Restricted Access Area**

Equipment is intended for installation in Restricted Access Area

Les matériels sont destinés à être installés dans des EMBLEMES À ACCÈS RESTREINT.

1.3 Rack Mount Instructions

1. Elevated Operating Ambient - If installed in a closed or multi-unit rack assembly, the operating ambient temperature of the rack environment may be greater than room ambient. Therefore, consideration should be given to installing the equipment in an environment compatible with the maximum ambient temperature (T_{ma}) specified by the manufacturer.
2. Reduced Air Flow - Installation of the equipment in a rack should be such that the amount of air flow required for safe operation of the equipment is not compromised.
3. Mechanical Loading - Mounting of the equipment in the rack should be such that a hazardous condition is not achieved due to uneven mechanical loading.
4. Circuit Overloading - Consideration should be given to the connection of the equipment to the supply circuit and the effect that overloading of the circuits might have on overcurrent protection and supply wiring. Appropriate consideration of equipment nameplate ratings should be used when addressing this concern.
5. Reliable Earthing - Reliable earthing of rack-mounted equipment should be maintained. Particular attention should be given to supply connections other than direct connections to the branch circuit (e.g. use of power strips)."
6. Connected to a mains socket-outlet with a protective earthing connection.
7. The socket-outlet shall be installed near the equipment and shall be easily accessible.

PDU Specifications

AC Input	200-240Vac, 50/60Hz
i-PDP Connector	Anderson Power pole Pak (Not a Hot Pluggable module) Single Phase: 24A (30A De-rating) 3-Phase Wye (4W+PE): 24A (32A De-rating) 3-Phase DELTA (3W+PE): 40A (50A De-rating)
Outlet	IEC60320 C13 Dual outlet (Sockets Qty. = 2 x 9 pcs) IEC60320 C13 Triple outlet (Sockets Qty. = 3 x 3 pcs) Total 27 sockets, 10A total for each C13 Outlet
Circuit Breaker	Dual pole circuit breaker 240V/20A, 2 pole x 12, ,10kAIC
Smart Board	Ethernet port x 1 (RJ45) Console Port x 1 (USB Type-C) Max Current = 100mA Daisy Chain port x 2 (RJ11) Environment Sensor port x 2 (RJ12) for temperature & humidity sensor Hot Pluggable with OLED Monitor
Mechanical Part	Tool-less Mounting with AC Retainers x 27 + Handle x 2 + Locking pin x 1
Dimension	2.3”(W) x 71”(L) x 4” PDU C13 outlet area /5” PDP area (D)

1.4 Universal 0U iPDU – Outward and Dimension

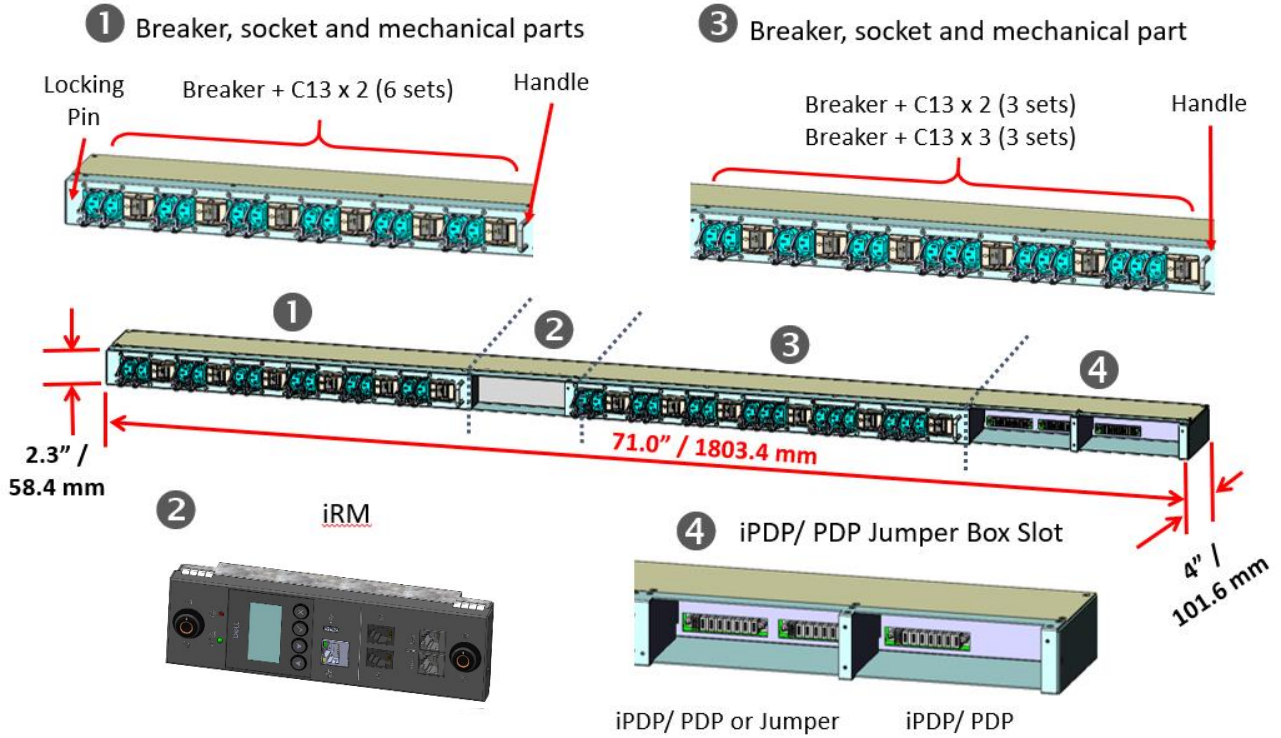

1.5 3-phase DELTA – Wiring Diagram

iPDP (PDP) and Jumper Box can carry 40A (50A De-rating)

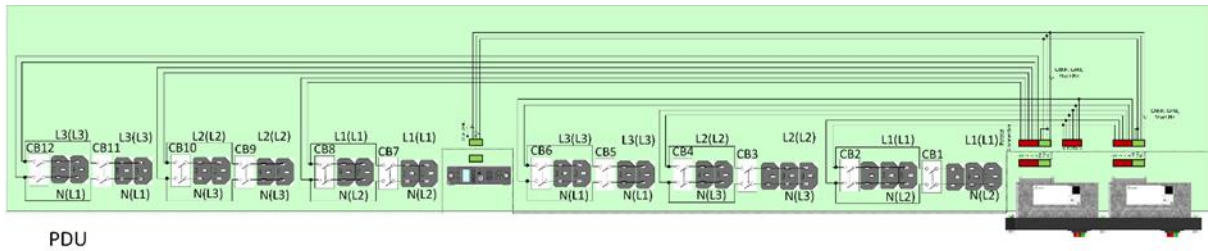

1.6 3-phase WYE– Wiring Diagram

iPDP (PDP) and Jumper Box can carry 24A (32A De-rating)



PDU



1.7 Single phase – Wiring Diagram

iPDP (PDP) and Jumper Box can carry 24A (30A De-rating)

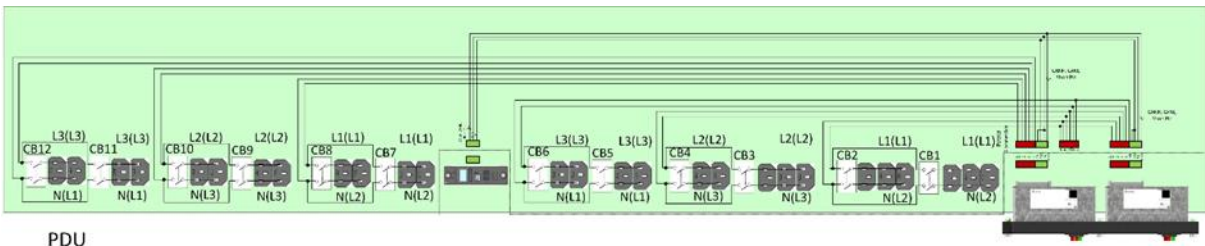

PDU



1.8 Communication Module Interface

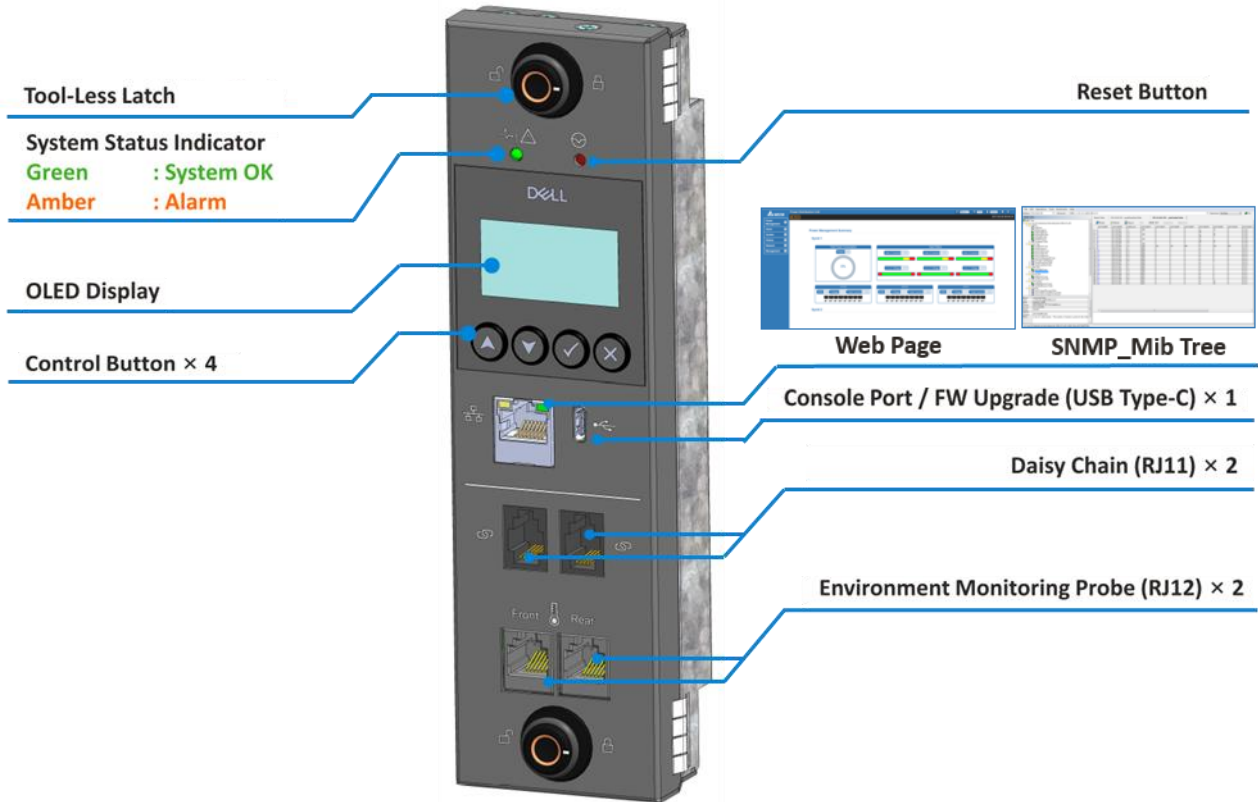

2 Startup

Before powering on the PDU, the hardware should be checked in accordance with procedure below.

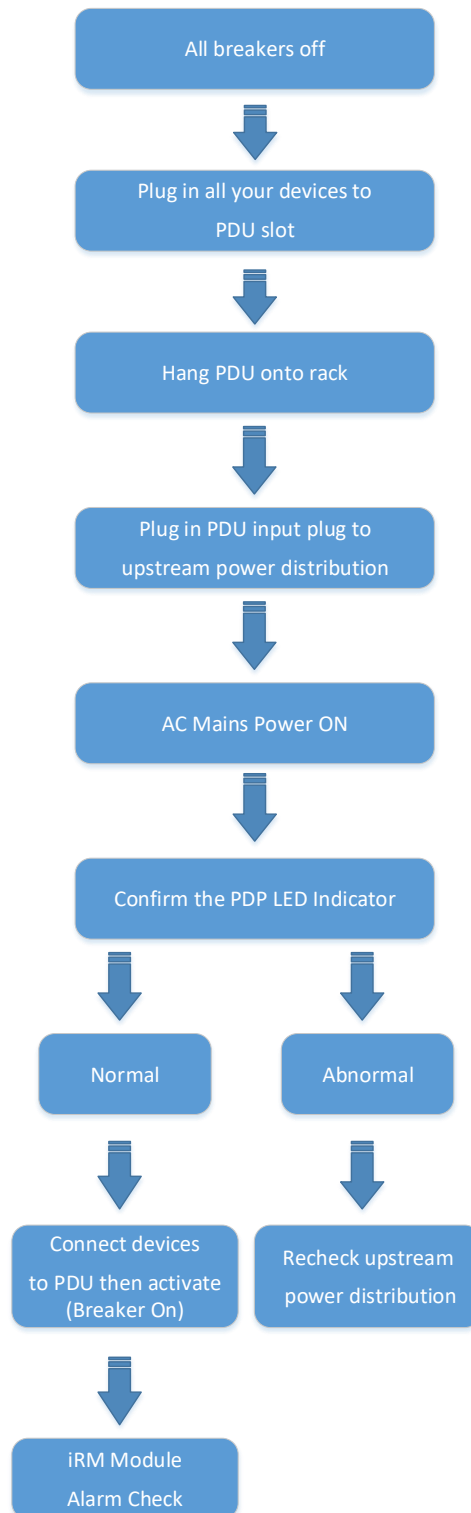

3 Installation

SETP 1 : Unpacking

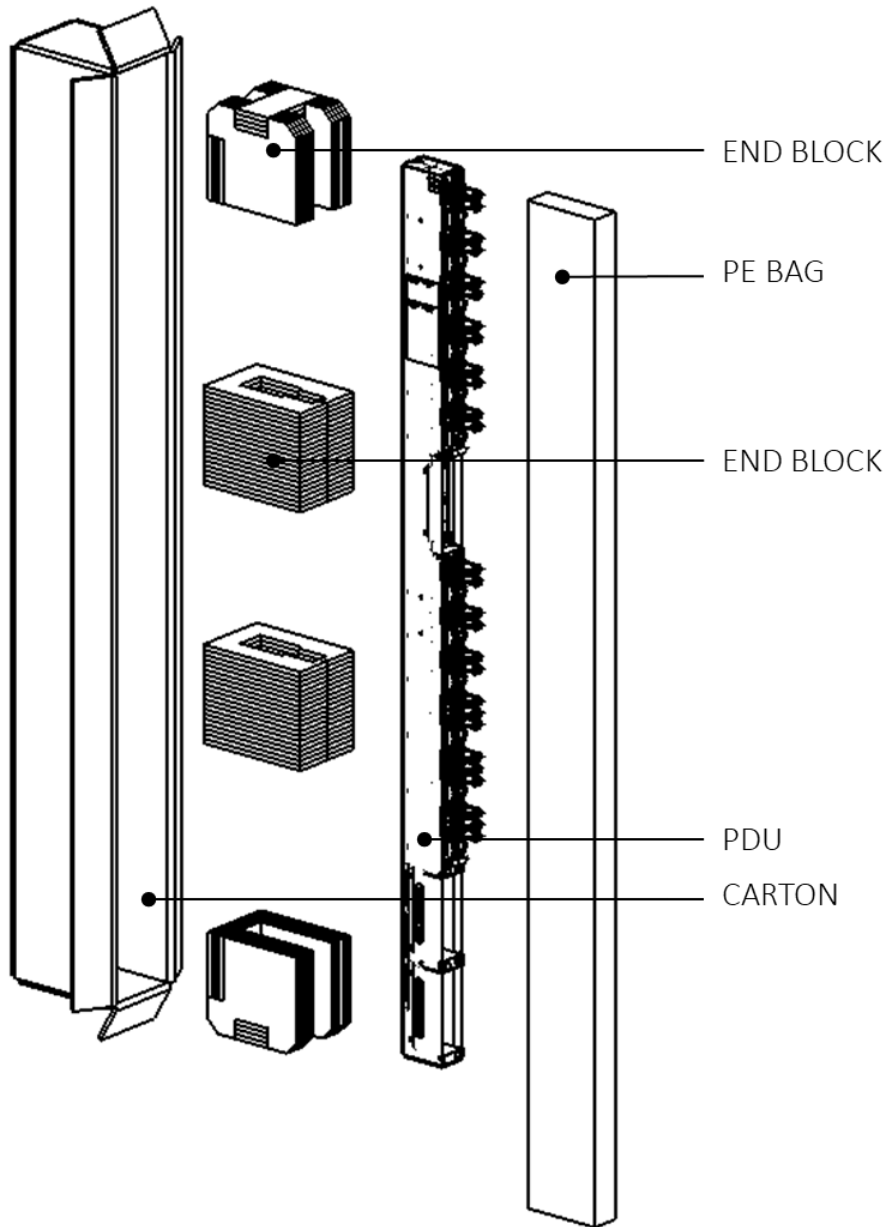

STEP 2 : Install and Uninstall iRM / EMP / iPDP / PDP Module

● Installation of iRM

Step 1

Press the pins on the back, press the knobs to make the both knobs pop out.

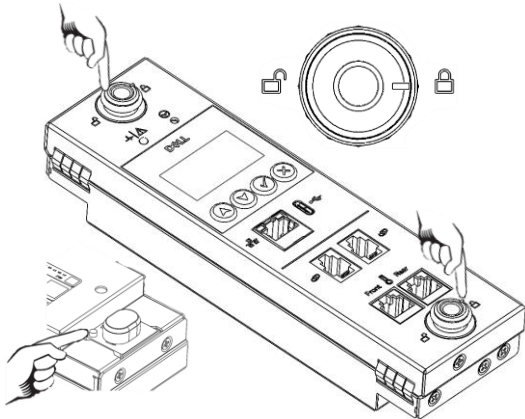

Step 2

Turn the both knobs to "open" status.

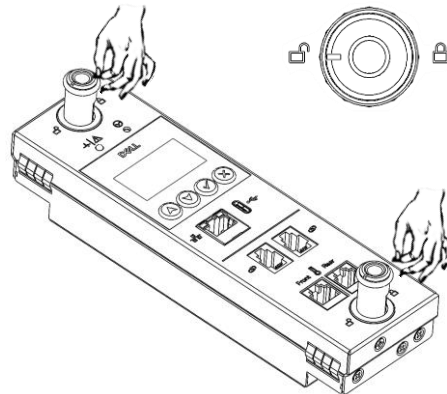

Step 3

Plug the iRM into the shelf, so that the pins are sunk into the latch body.

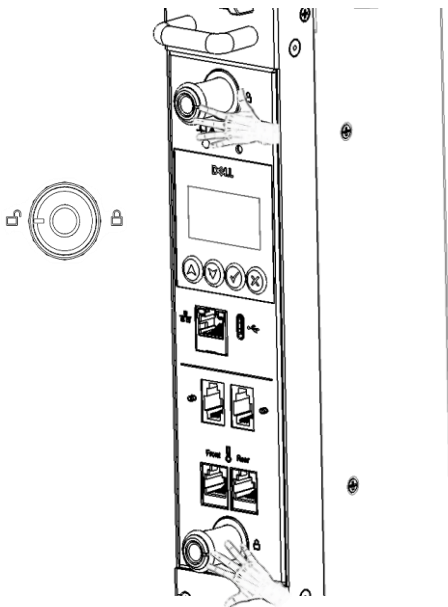

Step 4

Turn the both knobs to "close" status, then push the knobs.

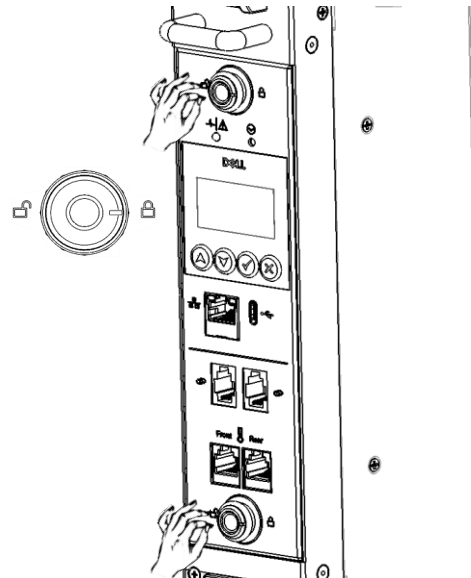

● **Uninstallation of iRM**

Step 1

Press the knobs to make the both knobs pop out.

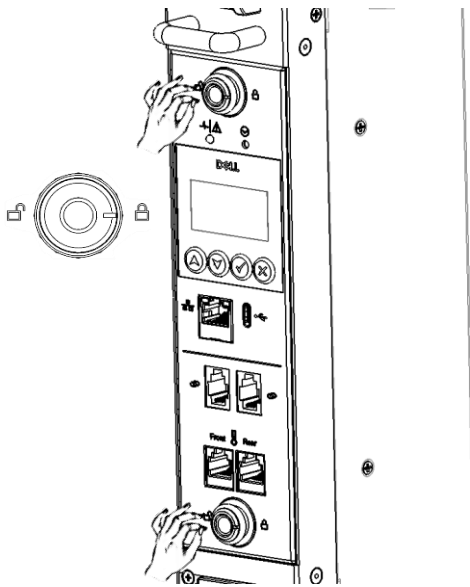

Step 2

Turn the both knobs to "open" status, then pull the iRM

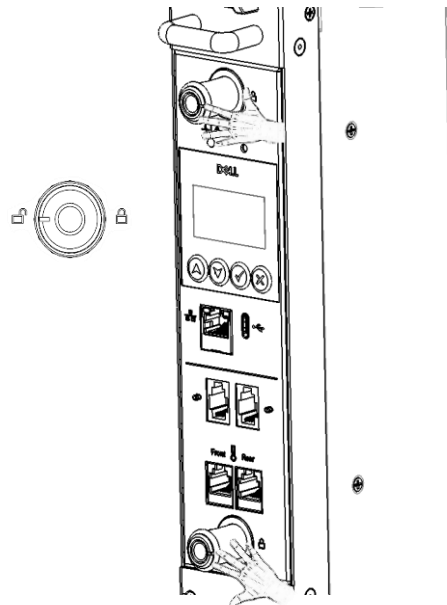

Caution! If the knob turns unsmoothly or reaches the dead point, do not force the knob any further. Please release and try again. This may prevent damage to the internal mechanism of the latch.

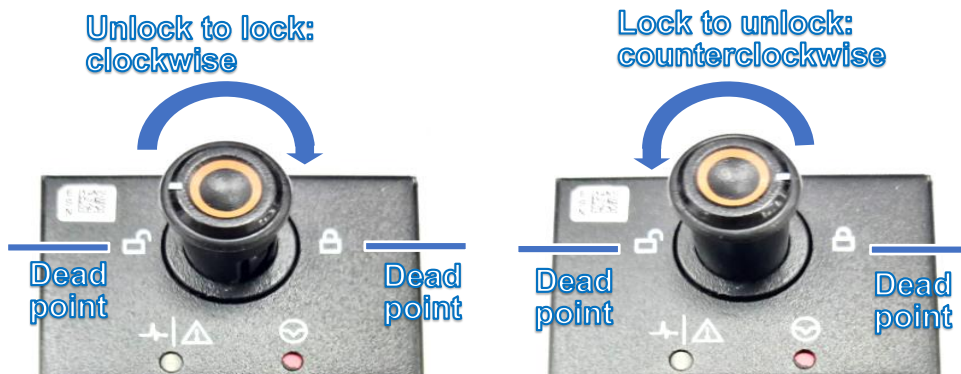

Do not over-turn the knob when reaching the dead points.

- **Installation of EMP**

Environment Monitoring Probe (EMP) temperature and humidity are stable after PDU power on 25 minutes.

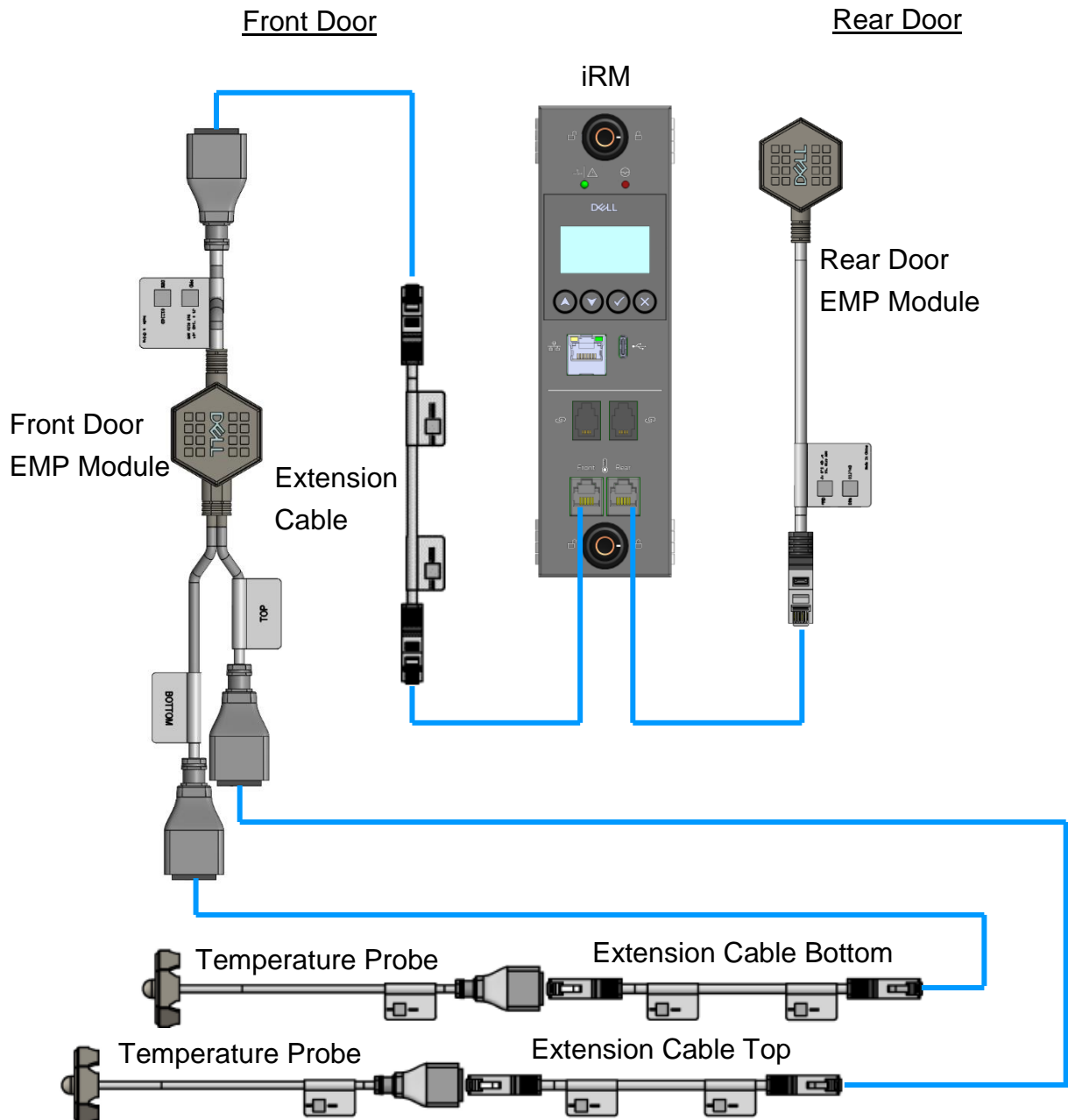

- Installation of iPDP & PDP
 - PDP slots & iPDP type

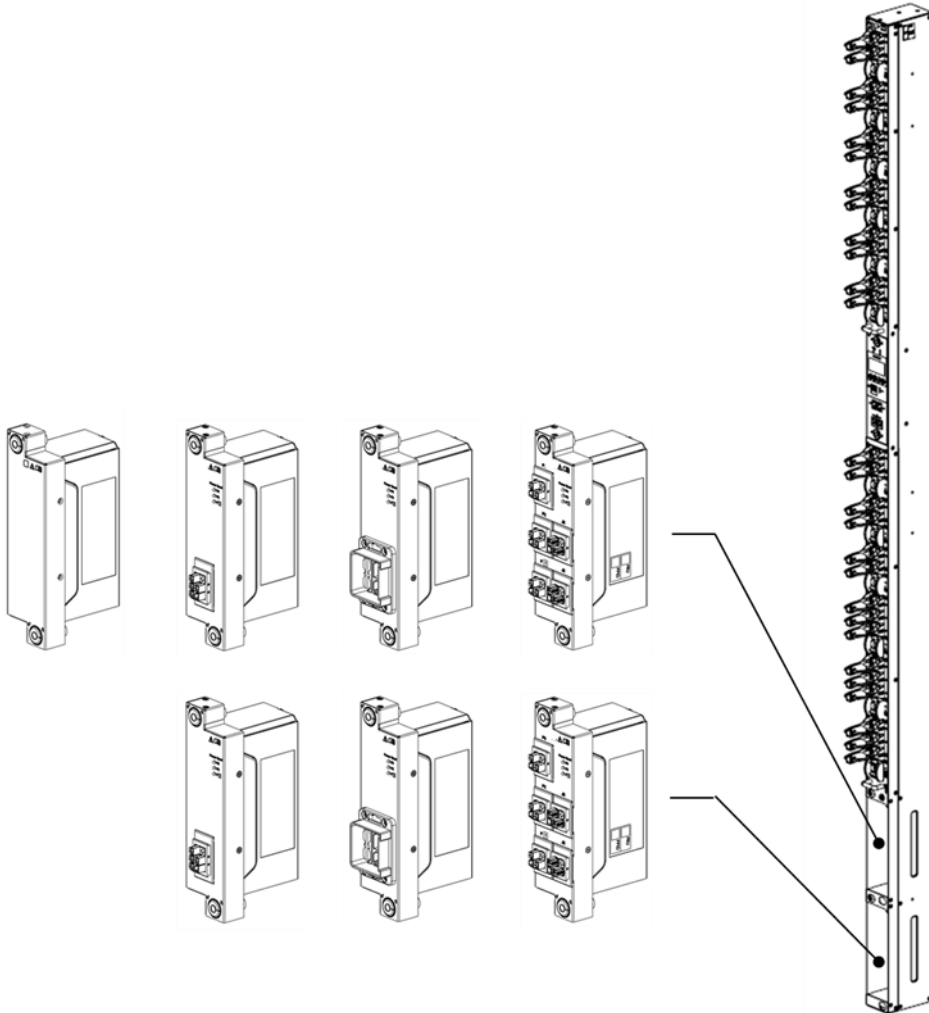

- To be installed state

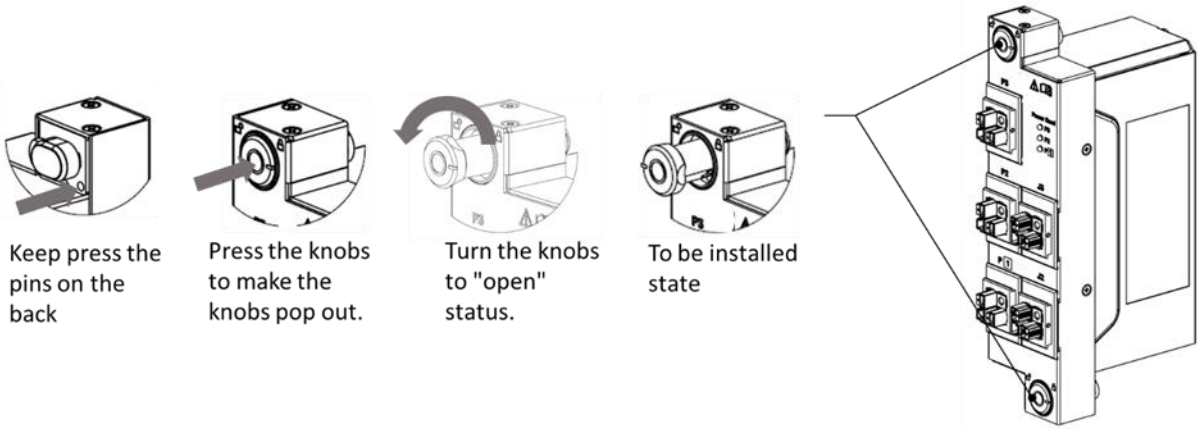

- Put iPDP(PDP) into the slot on the PDU.

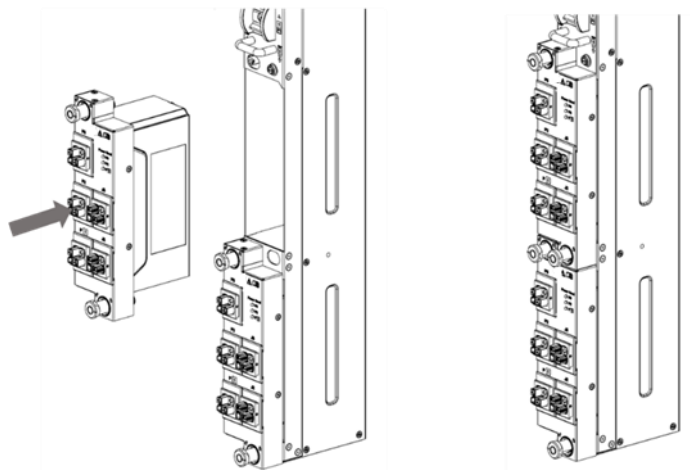

- Locked iPDP

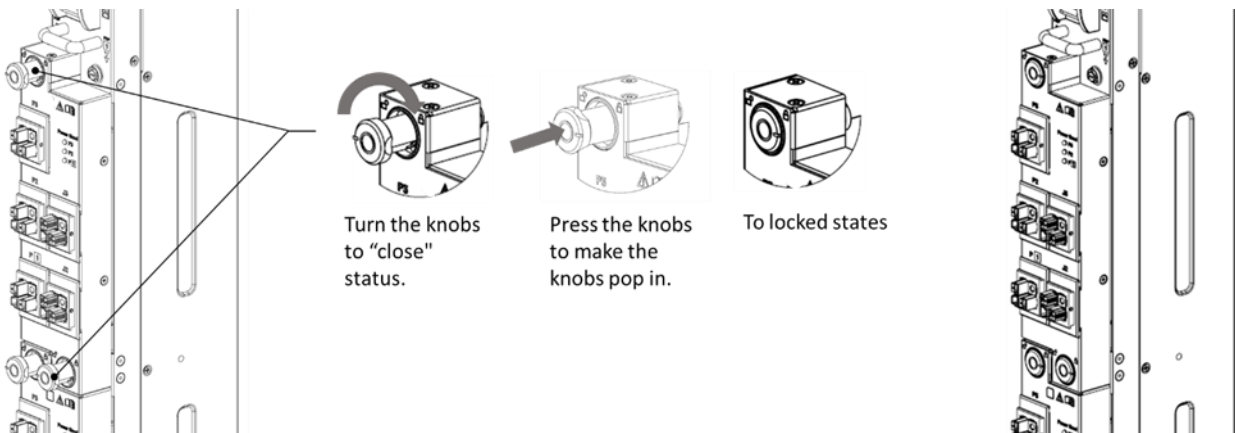

STEP 3:

Plug all iPDPs & Jumper box and connect all input power cords (as needed) with Anderson connector before connecting to the main AC source.

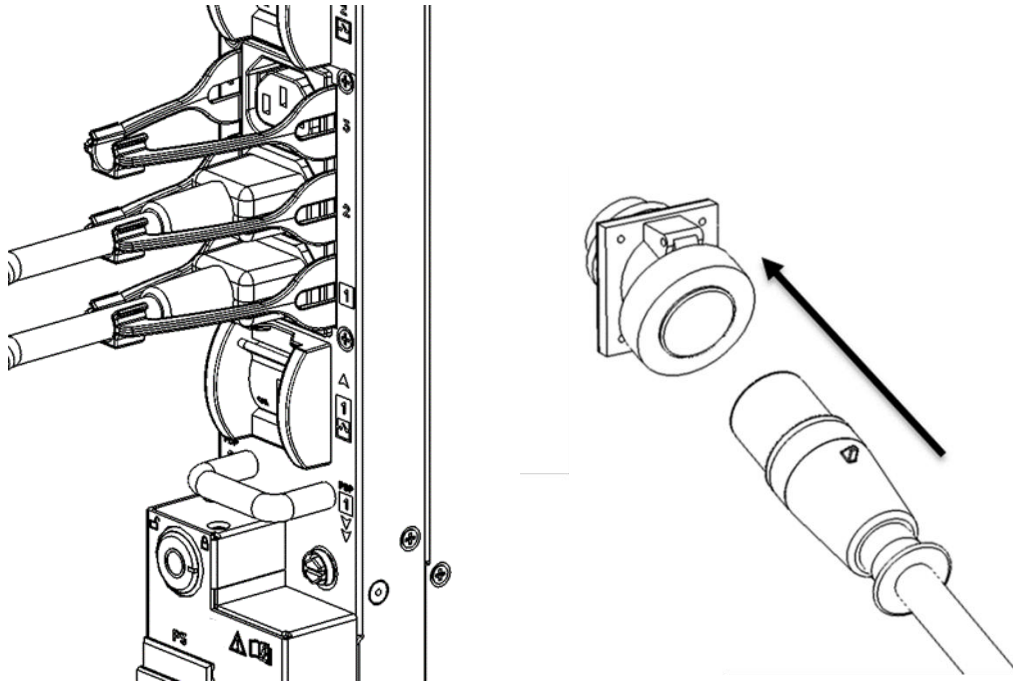

STEP4: PDP Input connection

- 3-Phase WYE PDP

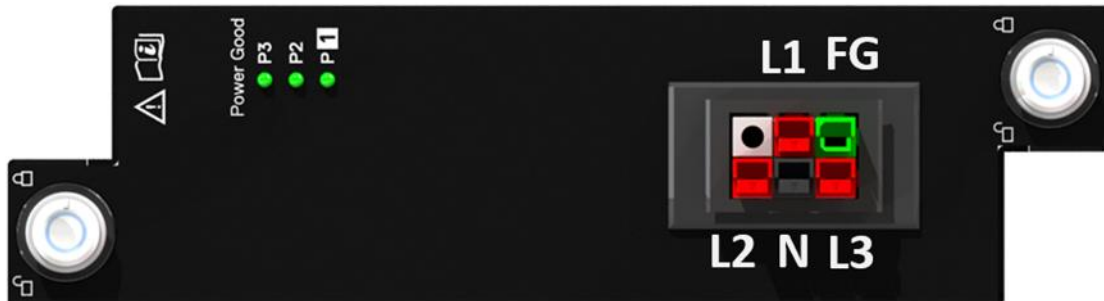

- 3-Phase Delta PDP

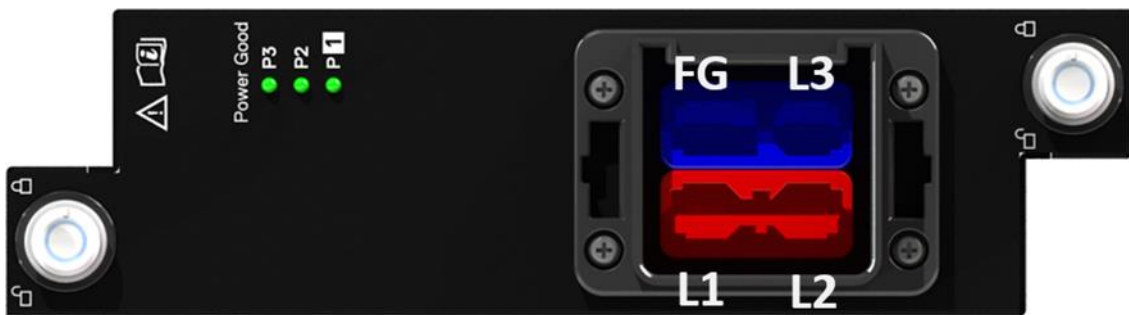

- 3 Input-Single Phase PDP (P1+P2+P3)
3 Input-Single Phase PDP AC input plug power supply from any phase Lx-Ly or Lx-N, below are AC input configurations.

	P1 - P3	P1' - P3'
Line-Line Input	Lx	Ly
Line-Neutral Input	Lx	N

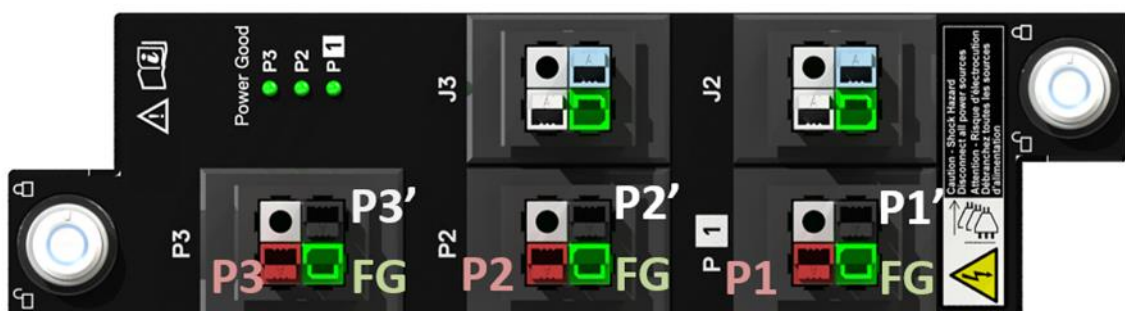

- Single Phase PDP with Jumper Cable

Jumper Cable is used to bypass output power to input power.

No.	Jumper Cable	Power Connection
A	J2 to P2	P1 bypass to P2
B	J3 to P3	P2 bypass to P3

- J2, J3 : Output Connector
- P1, P2, P3 : Input Connector

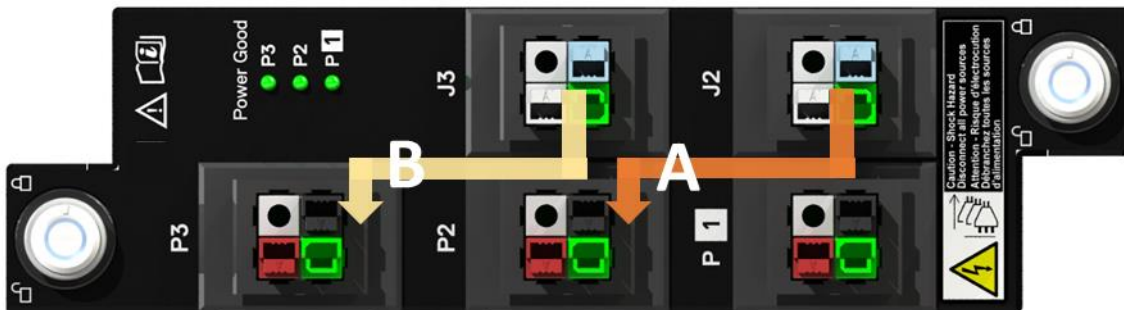

Caution! If the knob turns unsmoothly or reaches the dead point, do not force the knob any further. Please release and try again. This may prevent damage to the internal mechanism of the latch.

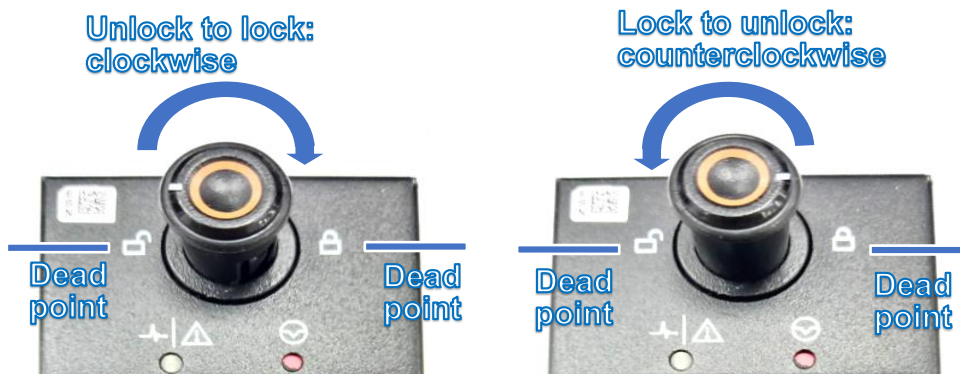

Do not over-turn the knob when reaching the dead points.

4 Management

4.1 Web Access

Please use LAN cable connected PDU and PC directly.

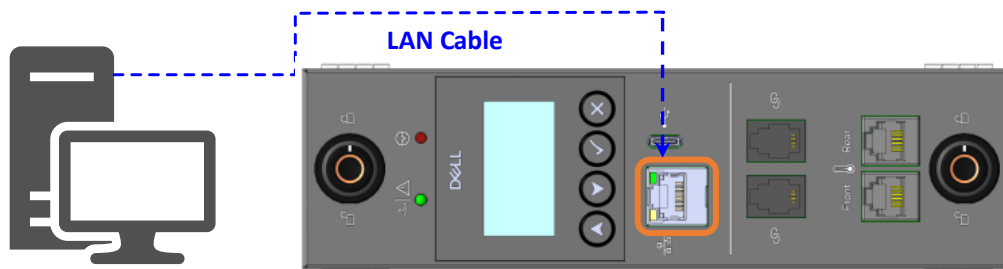

PC LAN Port Setting
 Address: 192.168.0.100
 Netmask: 255.255.255.0

PDU Default Network Setting
 TCP / IP Mode: *Static IP*
 Address: 192.168.0.1 (If no DHCP access, it is default IP)
 Gateway: 192.168.0.254
 Netmask: 255.255.255.0

Open the Web browser and enter IP address: **192.168.0.1**, you can see the log in screen as below, User Name: **Admin** Password: **00000000**
 Note, User Name needs to follow the rules of capitalization
 Web browser may use Microsoft Edge/Chrome



User Name	Default Password
Admin	00000000

4.2 Serial Port

User can prepare console cable (Typec C to Typec C) to iRM Module like below for PDU and PC connection

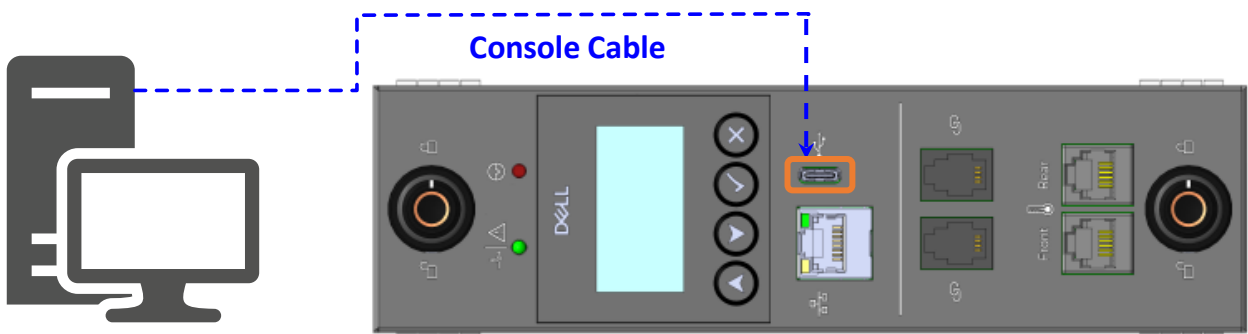

PC Tera Term Setting

COM Port: please check your PC Device Administrator
Baud Rate: 115200 bps

Network Information Check

- Install Driver : CP210x Universal Windows Driver
<https://www.silabs.com/developers/usb-to-uart-bridge-vcp-drivers>
- Follow the path:
This PC→Control Panel→System and Security→Device Manager→ Ports (COM & LPT).
Then you will see COM port number.

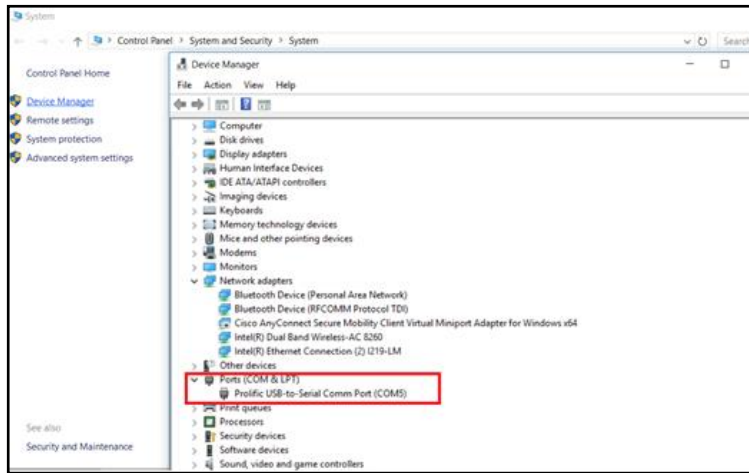

Step 1 (Demonstrate with Tera Term setting)

To configure serial port, click Setup and select Serial Port.

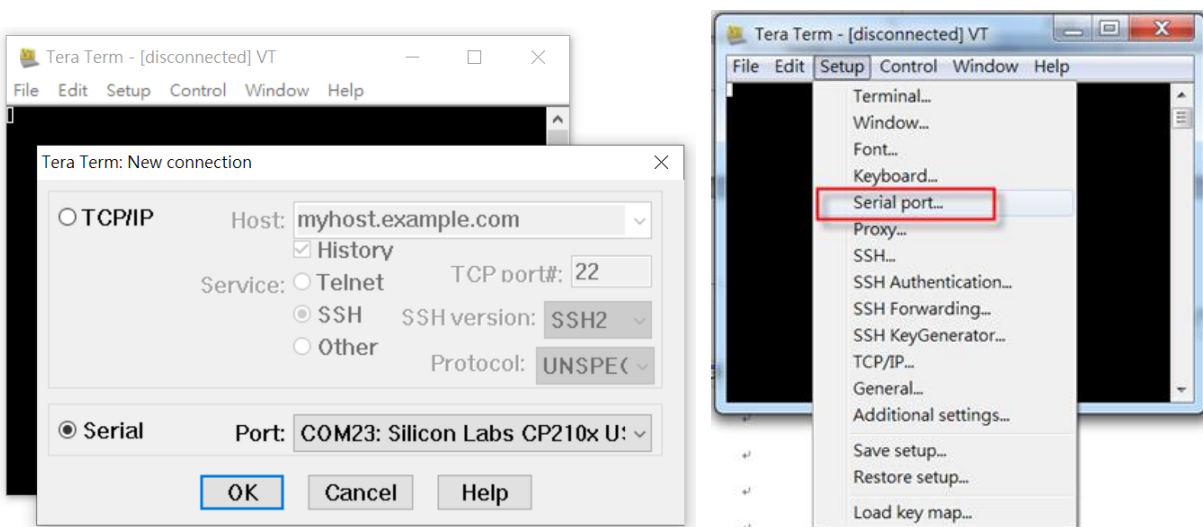

Step 2 Configure Port/ Baud rate.

Port	Select the COM port that is connected.
Baud rate	Select the parameter: 115200.

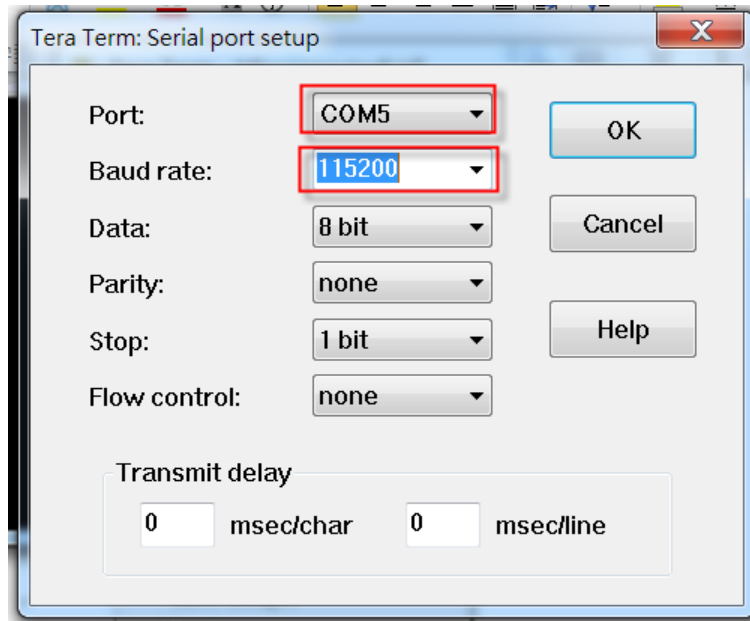

Step 3 Power on PDU and wait 30sec for communication module entering to operating system, then the screen will be displayed as shown below.

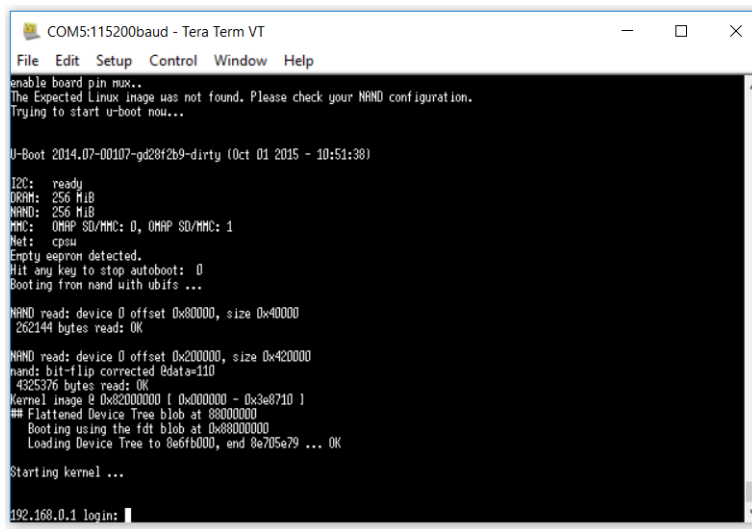

Step 4 Login PDU console menu

Login	<i>Admin</i>
Password	00000000

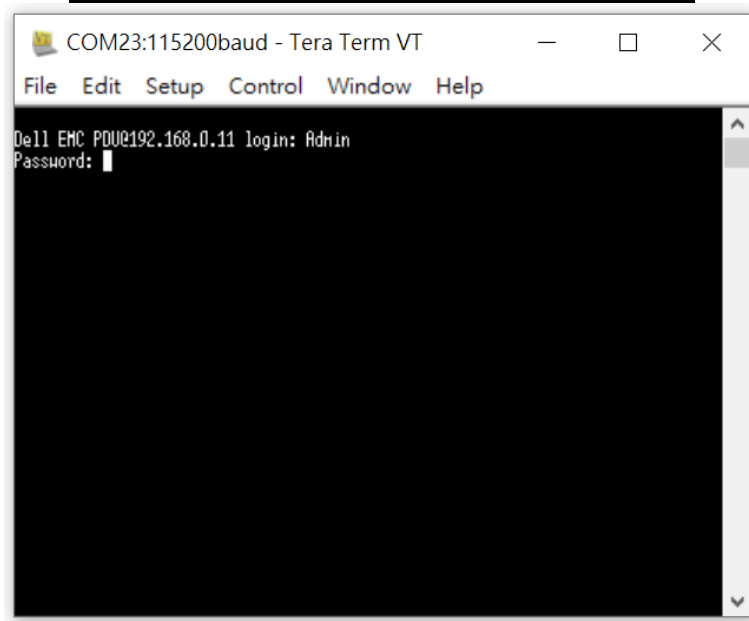

Step 5 System console menu

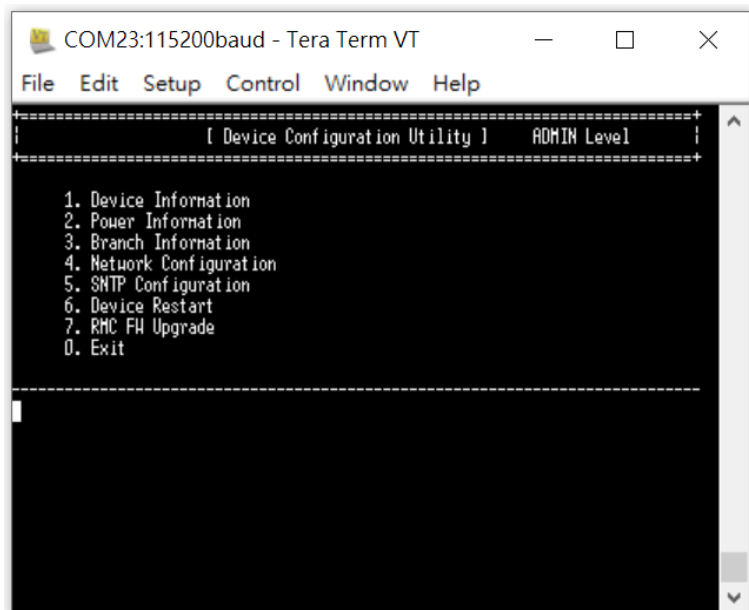

4.3 Serial Console to Upgrade Firmware

iRM supports firmware upgrade via serial console port with y-modem.

Limitation:

To use this function, use must use serial console port.

Only users with ADMIN privilege support this function.

Must use a console program that supports both CLI and y-modem.

The function has built-in timeout timing, so user must be familiar with the entire operation.

Operation Steps:

1. Login with a user that has ADMIN privilege, for example Admin/00000000
2. Choose 7. RMC FW Upgrade

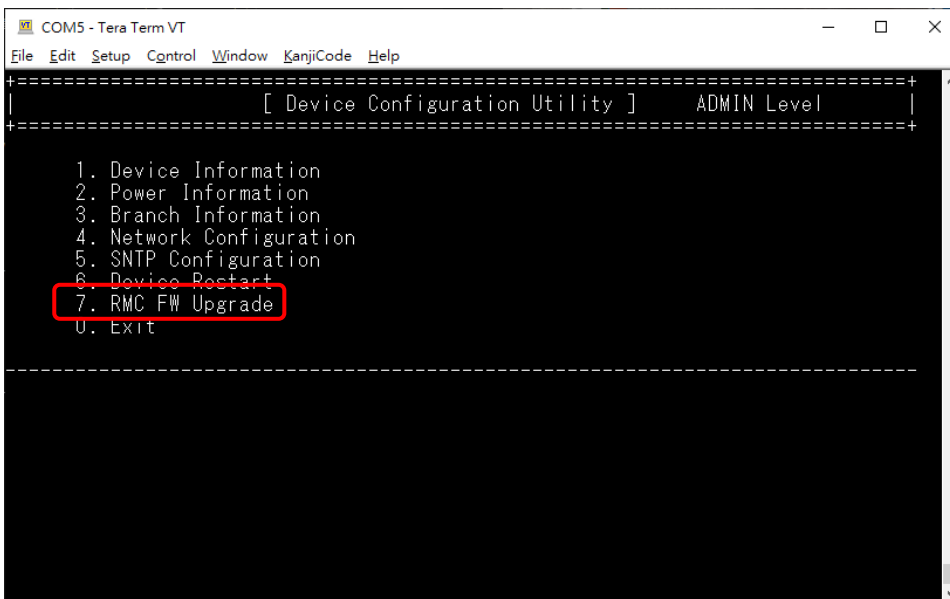

```
COM5 - Tera Term VT
File Edit Setup Control Window KanjiCode Help
-----+-----
[ Device Configuration Utility ] ADMIN Level
-----+-----
1. Device Information
2. Power Information
3. Branch Information
4. Network Configuration
5. SNTP Configuration
6. Device Restart
7. RMC FW Upgrade
U. Exit
-----+-----
```

3. Choose 0. Run

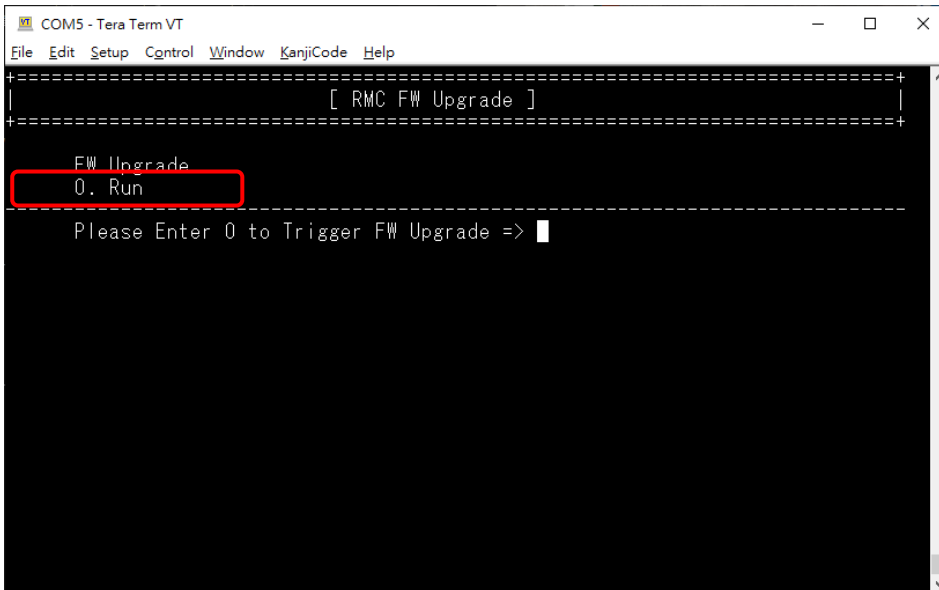

4. Choose file to upload

After seeing Begin recv... on screen, choose a file, please notice that user has to finish choosing file as soon as possible before receiver times out.

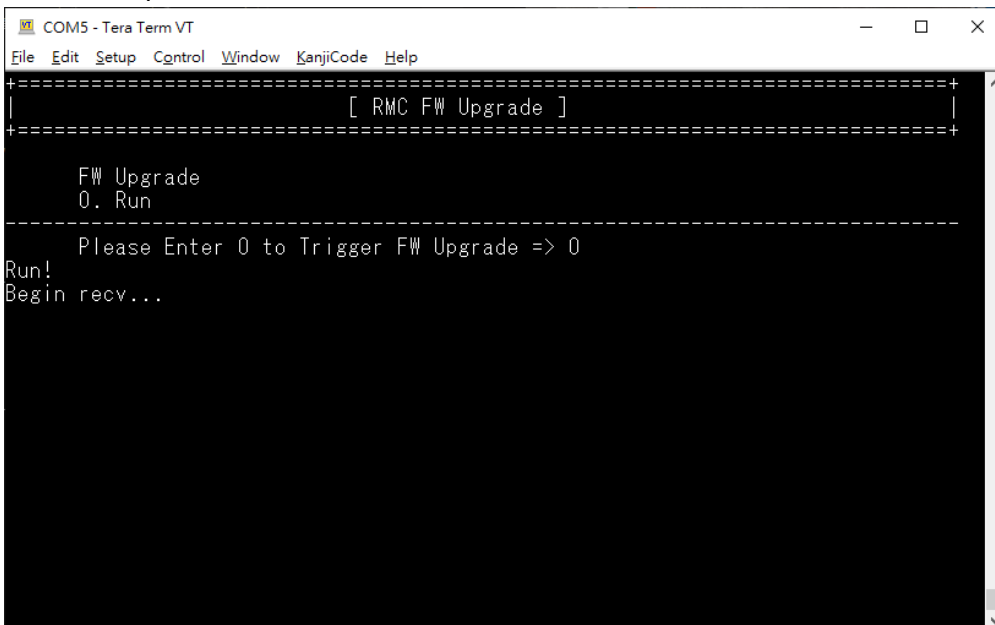

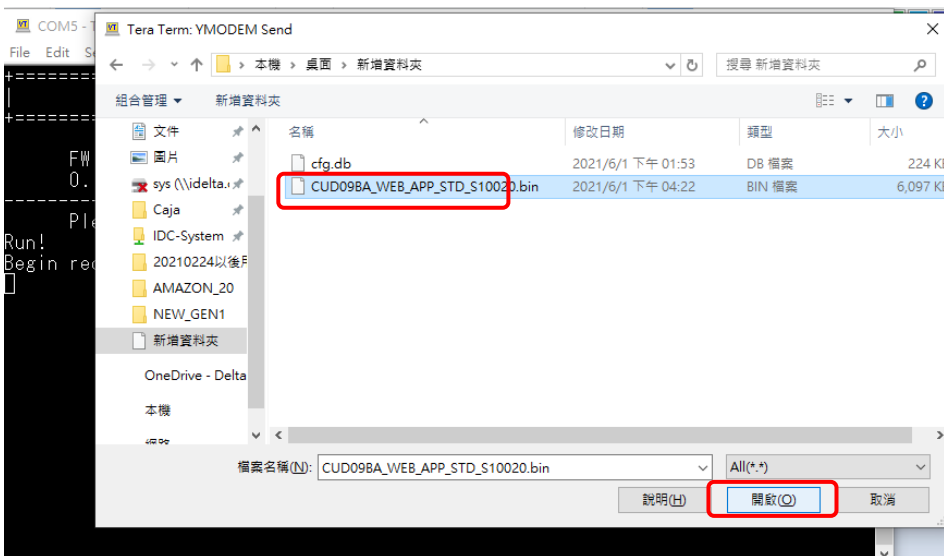
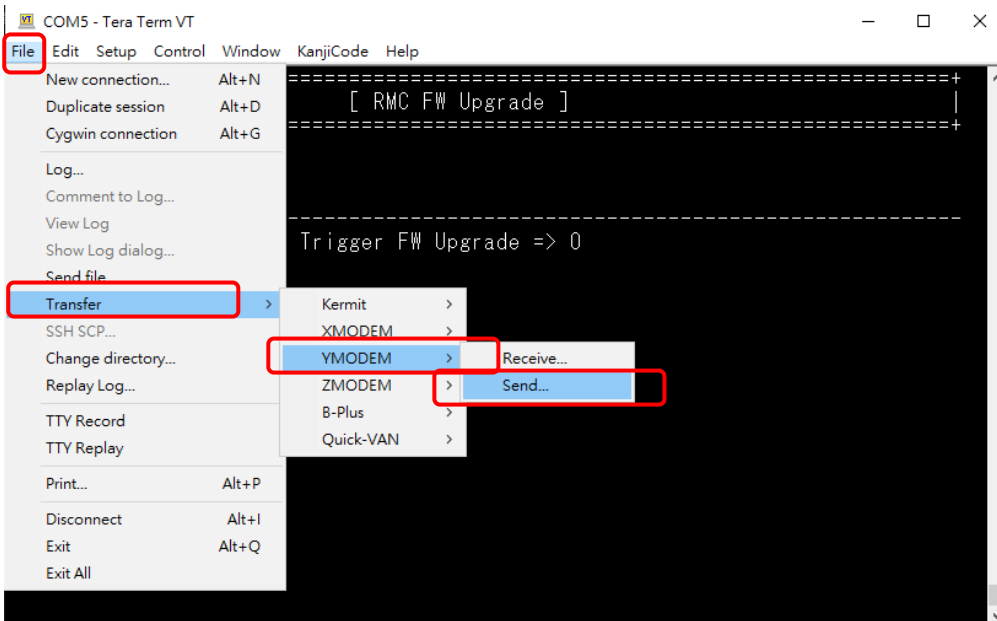

If receiver timeout, we will get something like below screen, just hit enter once to leave and retry.

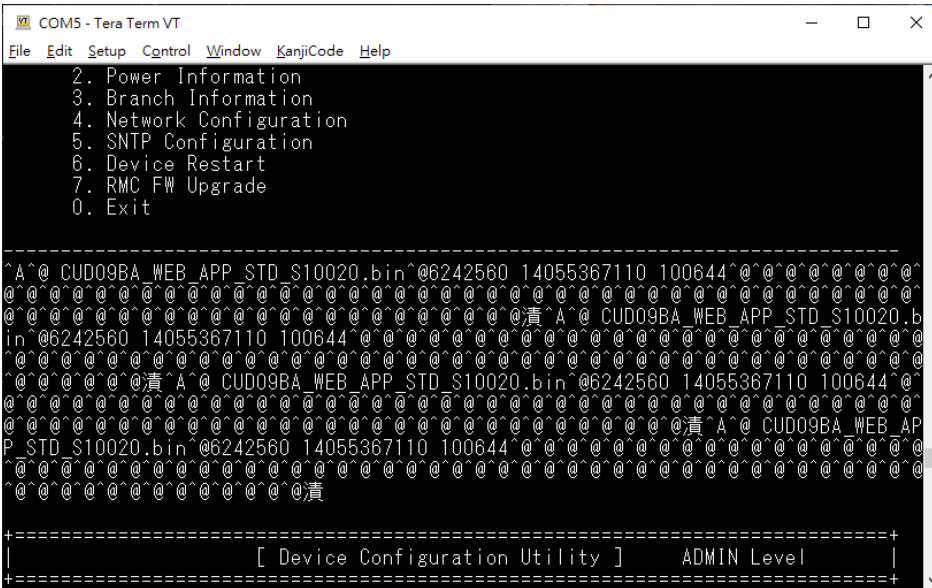

If receiver did not timeout, the transfer screen should appears couple of seconds after file chosen.

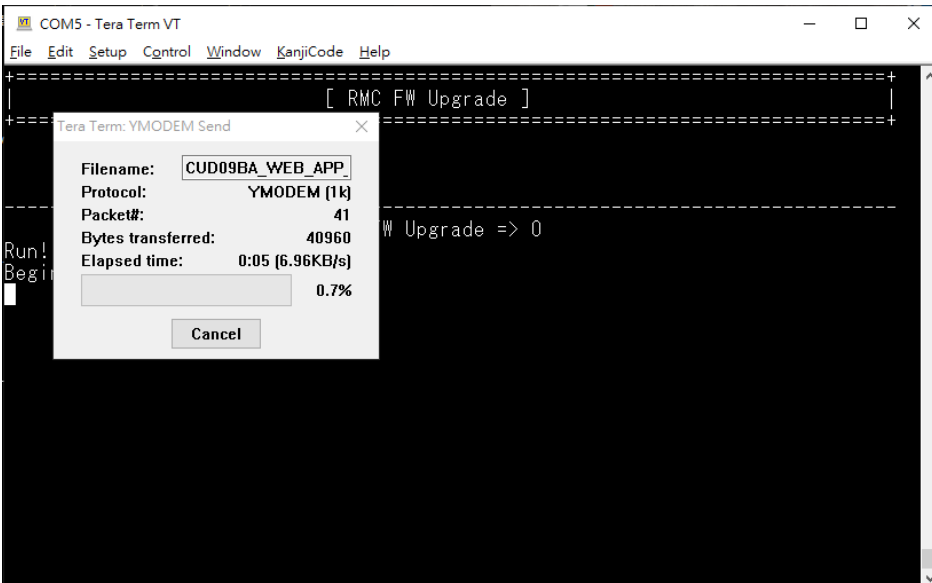

Just wait until file transfer complete. If file has correct format, system will upgrade the firmware and then reboot automatically.

5 ENVIRONMENTAL

5.1 TEMPERATURE

OPERATING (please ref dec 108000336)

0 to 50°C.

HIGH Temperature Test

Up to 60°C excursion for 24 hours without damage to components

5.2 HUMIDITY

OPERATING

-12°C DP & 8% RH to 90% RH relative humidity (non-condensing).

5.3 ALTITUDE

OPERATING

0 to 10,000 feet (0 to 3050 meters), altitude change rate between testing conditions to be at least 2000 ft/min.