



FEATURES

- Efficiency up to 92.4%
- Wide input range, 9V-36V
- Package with Industry Standard Pinout
- Package Dimension:
 - Without heat sink
50.8 x25.4 x10.5mm (2.0" x1.0" x0.41")
 - With heat sink
50.8 x25.4 x17.5mm (2.0" x1.0" x0.69")
- Over voltage protection, hiccup mode
- Over current protection, hiccup mode
- Positive or Negative Remote ON/OFF
- Without tantalum capacitor inside module
- Operating Temperature range - 40°C to +85°C
- Input to Output Isolation: 1500VDC
- RoHS Compliant
- 3 Years Product Warranty
- Heat-sink is option
- UL60950, 2nd Edition, (Approval pending)

The S24SP family, the highest power density (60W) industrial input range 2"X1" isolated power converter whose pinout follows industry standard. The S24SP series comes with a host of industry-standard features, such as over current protection, over voltage protection, over temperature protection and remote on/off. An optional heatsink is available for more extreme thermal requirements. All models have an ultra-wide 4:1 input voltage range (9V to 36V). With operating temperature of -40°C to +85°C, it is suitable for customers' critical applications, such as process control and automation, transportation, data communication and telecom equipment, test equipment, medical device and everywhere where space on the PCB is critical

Model List

Model Number	Input Voltage (Range)	Output Voltage	Output Current		Input Current (typ input voltage)		Load Regulation	Maxcapacitive Load (Cap ESR>=10mohm;Full load;5%overshoot of Vout at startup)	Efficiency (typ.)
			Max.	Min.	@Max. Load	@No Load			
			VDC	VDC	mA	mA			mA(typ.)
S24SP05012	24 (9 ~ 36)	5V	12000	0	2700	70	±25	20000	92.4%

Input Characteristics

Item	Conditions	Min.	Typ.	Max.	Unit
Input Surge Voltage (100 msec)		---	---	50	VDC
Input Turn-On Voltage Threshold		8	8.5	9	VDC
Input Turn-Off Voltage Threshold		7	7.5	8	VDC
Input Under-Voltage Lockout Hysteresis		0.4	1	1.7	VDC
Off-Converter Input Current	Vin=24V	---	10	---	mA
Input reflected ripple current	with 12uH, 20MHz	---	15	30	mA
Reverse Polarity Input Current		---	---	0.3	A
ON/OFF Control, Logic High	Von/off	2.4	---	10	VDC
ON/OFF Control, Logic Low	Von/off	-0.7	---	0.8	VDC
Input Filter		Internal LC Filter			

Output Characteristics

Item	Conditions	Min.	Typ.	Max.	Unit
Output Voltage Accuracy		---	---	±1	%Vo
Line Regulation	Vin=9V to 36V	---	---	±0.2	%Vo
Total Output Voltage Range	Over Load, Line and Temperature	---	---	±3	%Vo
Ripple & Noise	Vin=24V, Full Load	---	85	---	mV _{P-P}
Dynamic load response	50%-75% full load, 0.1A/uS	---	5	---	%Vo
Output Over Current Protection	Output Voltage 10% Low, Hiccup	110	---	150	%Io,max
Short Output Protection	Long Term, Auto-recovery				
Output Over-Voltage Protection	Hiccup, Auto-recovery	115	---	140	%Vo
Output Trim Range	Pout ≤ max rated power, Io ≤ Io,max	-10	---	+10	%Vo

General Characteristics

Item	Conditions	Min.	Typ.	Max.	Unit
I/O Isolation Voltage (rated)		---	---	1500	VDC
I/O Isolation Resistance		10	---	---	MΩ
I/O Isolation Capacitance		---	1500	---	pF
Switching Frequency		---	340	---	KHz

Environmental Specifications

Parameter	Conditions	Min.	Max.	Unit
Operating Temperature Range (with Derating)	Ambient	-40	+85	°C
Case Temperature		---	+105	°C
Storage Temperature Range		-50	+125	°C
Humidity (non condensing)		---	95	% rel. H
Cooling	Free-Air convection			

Power Derating Curves (No Heat Sink and With Heat Sink)

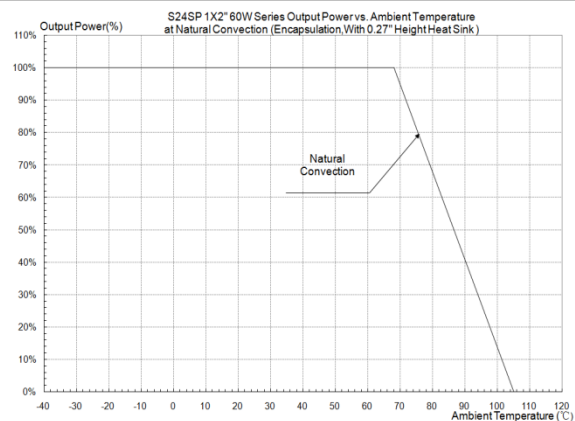
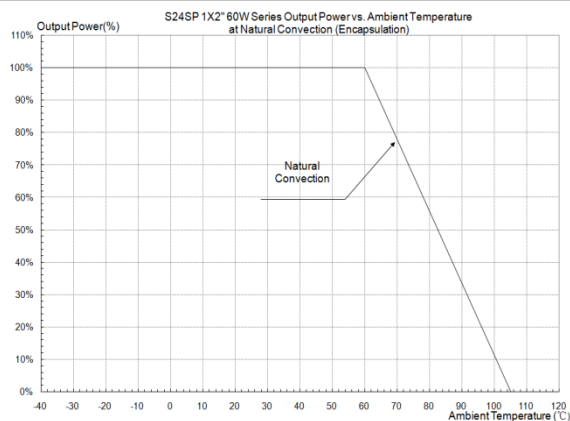

Notes

- 1 Specifications typical at Ta=+25°C, resistive load, nominal input voltage and rated output current unless otherwise noted.
- 2 Ripple & Noise measurement bandwidth is 0-20MHz, with 10μF, tantalum capacitor and 1μF ceramic capacitor.
- 3 DC/DC converters should be externally fused at the front end for protection.
- 4 Specifications are subject to change without notice.

ELECTRICAL CHARACTERISTICS CURVES - S24SP05012, 9-36VIN, 5V/12A

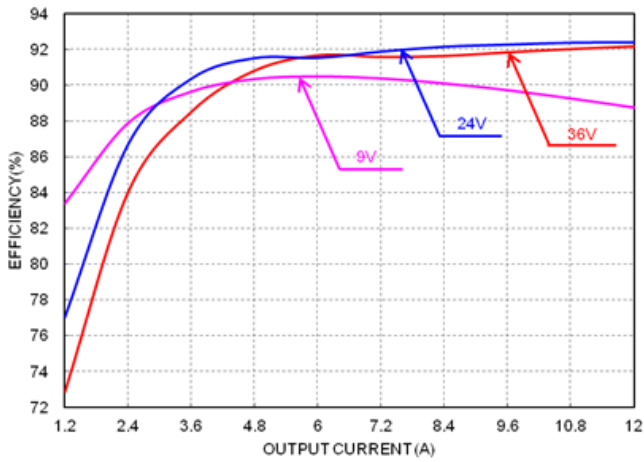

Efficiency vs. load current for various input voltage at 25°C.

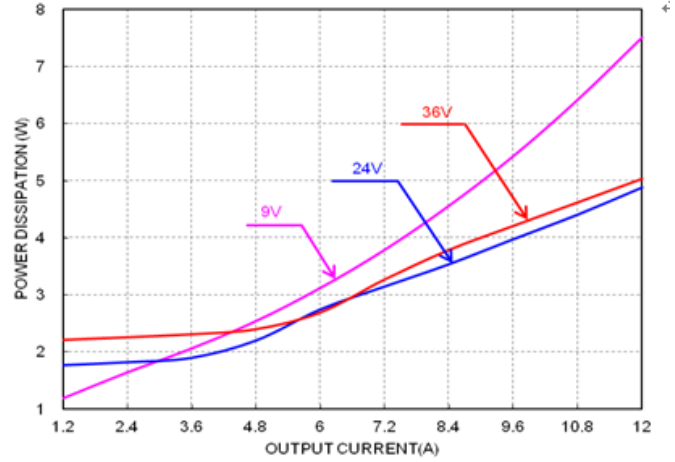

Power dissipation vs. load current at 25°C.

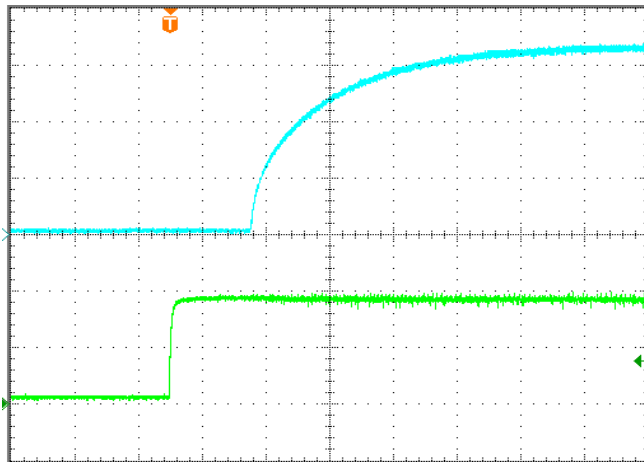

Turn-on transient at full load current (10ms/div).
Top Trace: Vout; 1.5V/div; Bottom Trace: ON/OFF input: 2V/div.

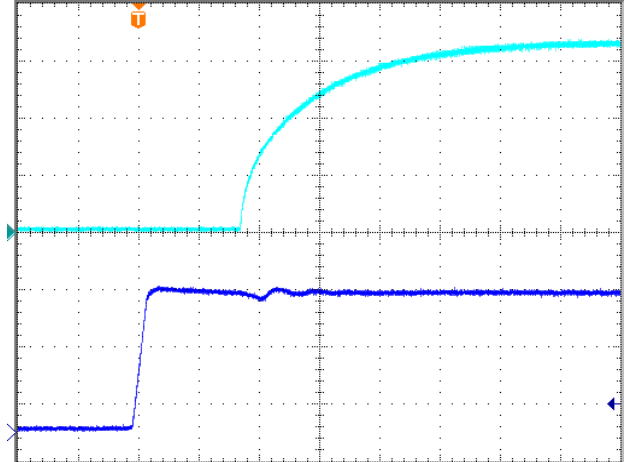

Turn-on transient at full load current (10 ms/div).
Top Trace: Vout; 1.5V/div; Bottom Trace: input voltage: 10V/div.

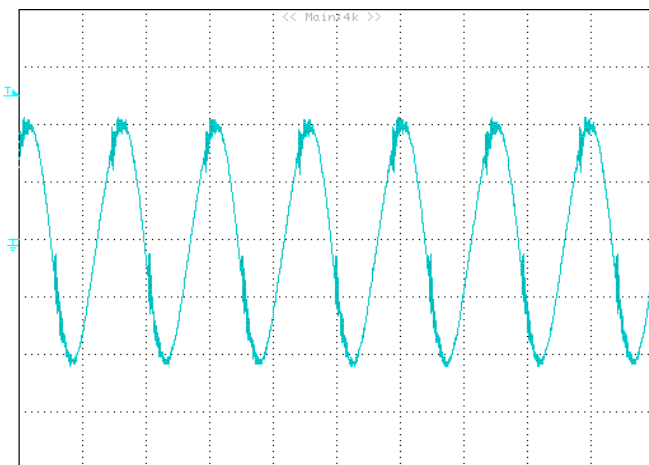

Output voltage ripple at nominal input voltage and max load current (20 mV/div, 2us/div)
Load cap: 10 μ F, tantalum capacitor and 1 μ F ceramic capacitor.
Bandwidth: 20 MHz.

Mechanical Drawing(without heat sink)

Mechanical Dimensions		Pin Connections	
		Pin	Function
		1	Vin+
		2	Vin-
		3	On/off
		4	Trim
		5	Vout-
		6	Vout+
<p>Physical outline</p> <p>Case Size: 58.4*25.4*9.5(2.0"*1.0"*0.38")</p> <p>Case material: Al alloy, anodize black</p> <p>Baseplate material: Non-conductive FR-4</p> <p>Pin material: Brass; finish: Matte Tin plating and Nickel under plating</p> <p>Pin length: refer part numbering system</p> <p>Weight: 34grams</p> <ul style="list-style-type: none"> ➤ All dimensions in mm (inches) ➤ Tolerance: X.X±0.5 (X.XX±0.02) X.XX±0.25 (X.XXX±0.010) ➤ Pins Diameter : ±0.10(±0.004) 			

Mechanical Drawing(with heat sink)

Mechanical Dimensions		Physical Outline	
		1	Heat sink
		Material: Al-6063	
		Finish: anodize black	
		Weight: 10.3grams	
		2	Clamp
		Material: spring steel	
		Finish: Nickel plating	
		3	Thermal pad
		Material: Sil-pad	
		Thermal conductivity: 1.6W/m-K	
		4	Model weight: 46grams
<ul style="list-style-type: none"> ➤ All dimensions in mm (inches) ➤ Tolerance: X.X±0.5 (X.XX±0.02) X.XX±0.25 (X.XXX±0.010) 			

Note:

1. add heat sink to help heat dissipation and increase reliability of convert operating at high ambient temperature
2. please refer derating curve while upgrate the operating temperature of converter
3. heat sink will be mounted for volume orders, separated heat sink only be supplied for prototype
4. for model with heat sink option, the recommended layout only need note the length more larger than without heat sink

Application notice:

For modules with through-hole pins, they are intended for wave soldering assembly onto system boards; please do not subject such modules through reflow temperature profile.

Recommended layout refer below

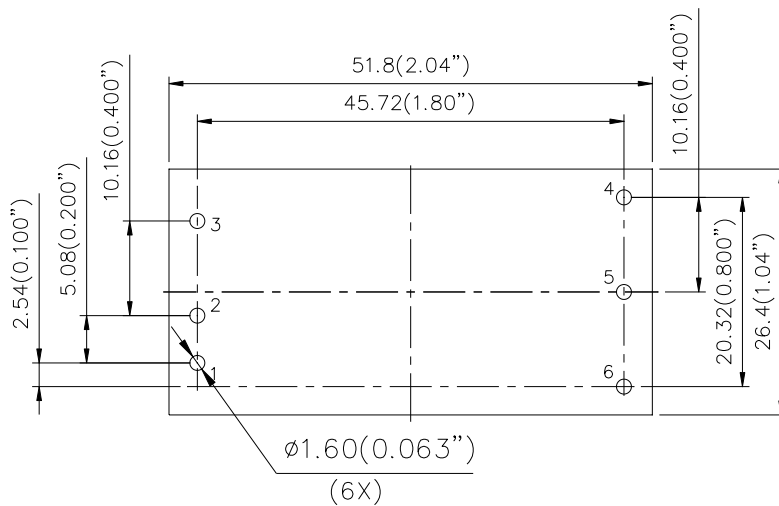

Pin#	Function
1	Vin+
2	Vin-
3	ON/OFF
4	Trim
5	Vout-
6	Vout+

Part Numbering System

S	24	S	P	050	12	P	D	F	A
Form factor	Input voltage	Number of output	Product series	Output voltage	Output current	On/off logic	Pin length		Option Code
S	24 – 9~36V	S - Single	P - Series Number	050 – 5V	12 – 12A	N - Negative	D - 0.24"	F - RoHS 6/6 (Lead Free)	A – Standard. (with metal case)
						P – Positive	T - 0.22"		H – With heat sink
							R - 0.17"		

CONTACT: www.deltaww.com/dcdc

USA:

Telephone:
 East Coast: 978-656-3993
 West Coast: 510-668-5100
 Fax: (978) 656 3964

Email: dcdc@deltaww.com

Europe:

Phone: +31-20-655-0967
 Fax: +31-20-655-0999

Asia & the rest of world:

Telephone: +886 3 4526107
 ext 6220~6224
 Fax: +886 3 4513485

WARRANTY

Delta offers a three (3) years limited warranty. Complete warranty information is listed on our web site or is available upon request from Delta.

Information furnished by Delta is believed to be accurate and reliable. However, no responsibility is assumed by Delta for its use, nor for any infringements of patents or other rights of third parties, which may result from its use. No license is granted by implication or otherwise under any patent or patent rights of Delta. Delta reserves the right to revise these specifications at any time, without notice.