

APPLICATION NOTE

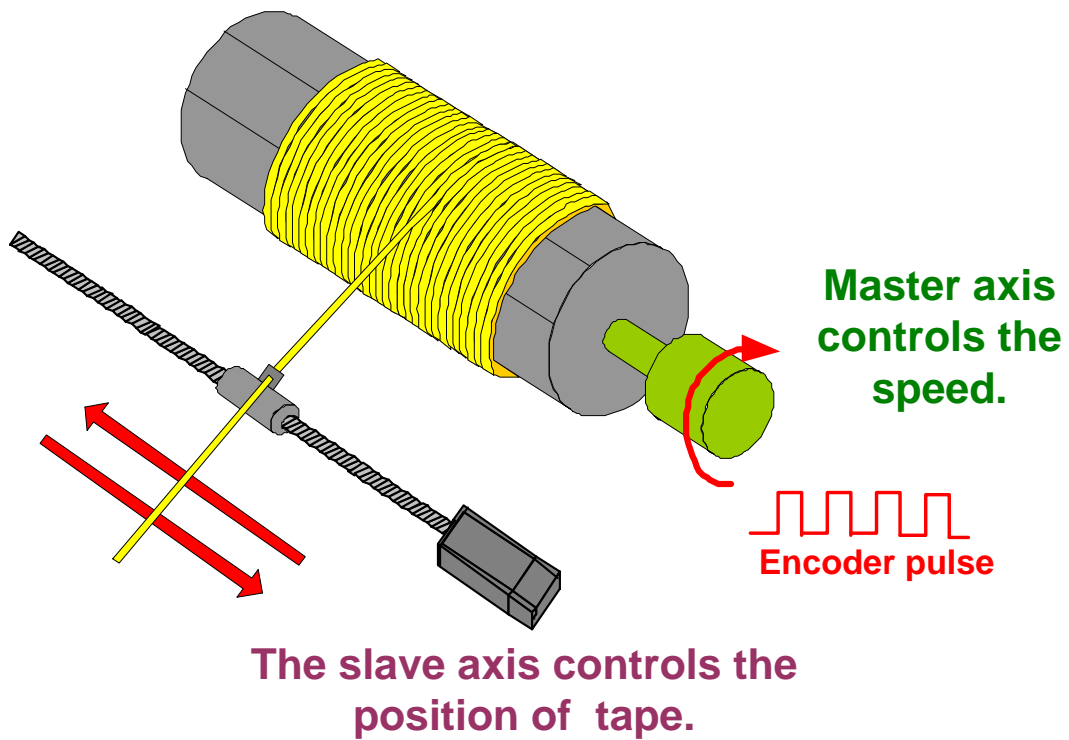

Industrial Automation Business Group

Note	Coil Winding Machine using A2 Servo Series				
Issue by	SC	Date	NOV, 2013	Pages	23
Applicable to	ASD-A2 series AC servo motor and drive				



Application Note for Coil Winding Machine

1	Description	3
2	System theorem and scheme.....	3
	2.1 Master axis	3
	2.2 Slave Axis (Tape Guide)	4
3	Servo system setting	4
	3.1 Tape placement.....	4
	3.2 E-cam curve design.....	6
	3.3 Example.....	8
	3.3.1 PR programming and execution	11
	3.3.2 System adjustment.....	16
4	Building the E-cam curve in ASDASoft	18

1 Description

This chapter describes the ASDA-A2 solution in a Coil Winding machine application. The configuration function of tape can be done by electronic cam of ASDA-A2. The ECAM in the drive incorporates multiple ECAM profiles with switching occurring at the ends with no lost pulses from the master axis. The main parameters such as the width of tape, the interval of tape and the length of bobbin can be modified easily to fit any application. The detailed description will be elaborated in later parts of this chapter.

2 System theorem and scheme

The bobbin is the master axis. When it rolls, it sends out the encoder pulse to command the slave axis simultaneously. The slave axis moves using its internal E-cam curve to coordinate motion with the master axis to finish the wrapping on the bobbin. The ASDA-A2 servo drive is mainly in charge of the configuration of tape.

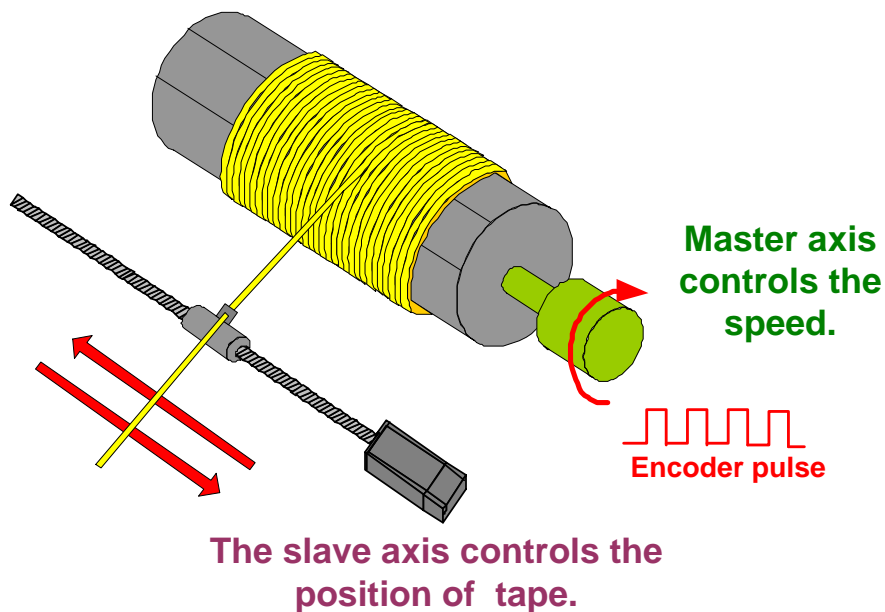

Diagram 2.1 Coil Winding machine system

2.1 Master axis

When the master axis rolls, it sends out the pulse to command the slave axis. If different lengths for the bobbin are required, we can adjust the parameters of the slave axis to complete the setting.

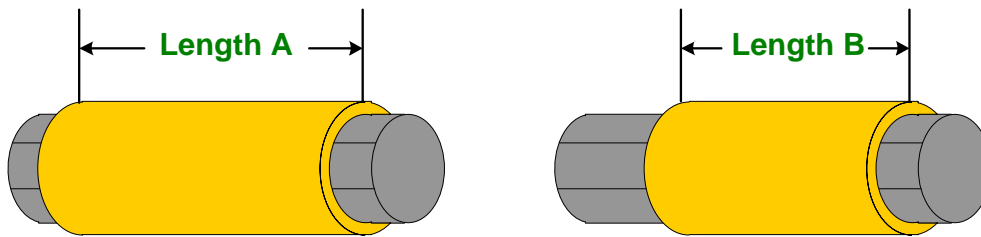

Diagram 2.2 Different length of bobbin

2.2 Slave Axis (Tape Guide)

This axis places the tape according to the pulse of master axis. The interval and width of the tape can be adjusted through the proper setting.

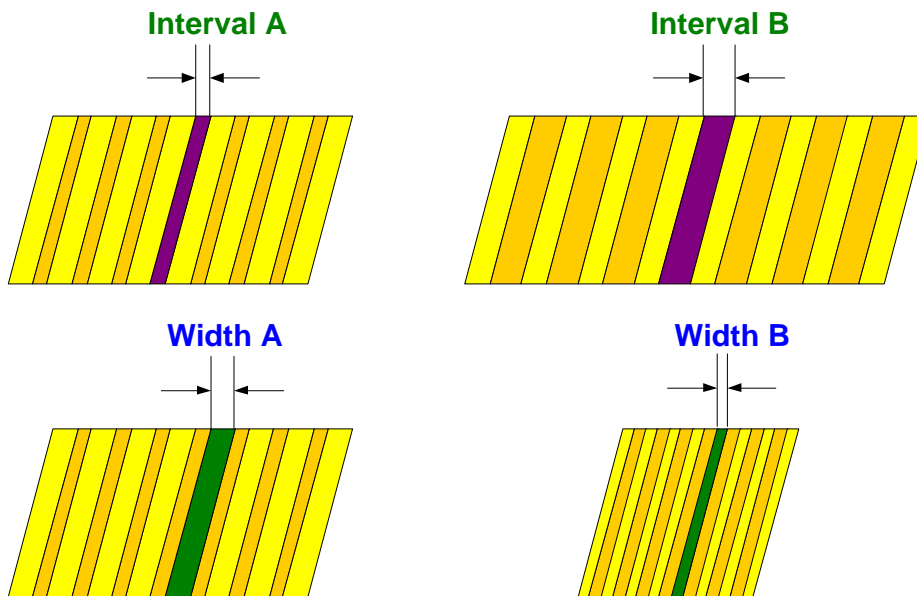

Diagram 2.3 Different interval and different width

3 Servo system setting

3.1 Tape placement

The start position of tape

Many times in this style application, there is a hole in the middle of the bobbin. The tape can be directly inserted and attached on the bobbin. The advantage to start winding from the middle point is that the tape will not loosen easily.

APPLICATION NOTE



Industrial Automation Business Group

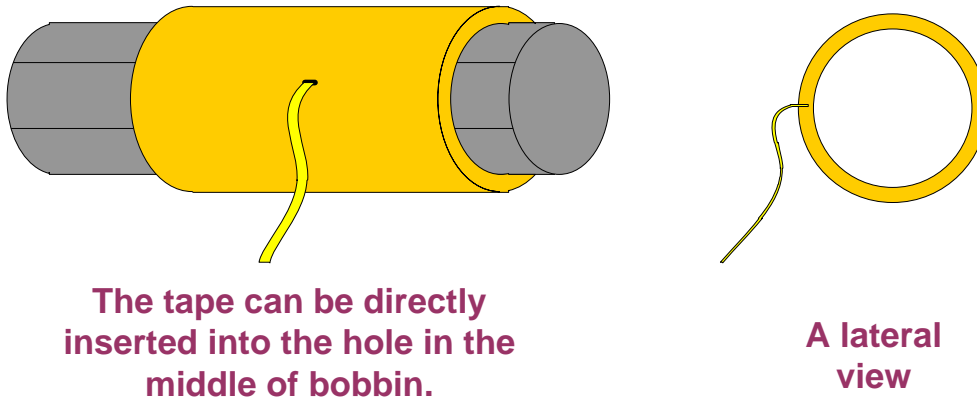

The tape can be directly inserted into the hole in the middle of bobbin.

A lateral view

Diagram 3.1 The start position of tape

The coil winding method

The tape starts from the middle point of the bobbin, goes to the end first and then goes back over and over again to complete the wrapping on the bobbin. When the tape is at the two ends, it is important to leave a specific length of material. This is for consolidation of the roll and helps tighten the two sides. The following is the diagram of wrapping.

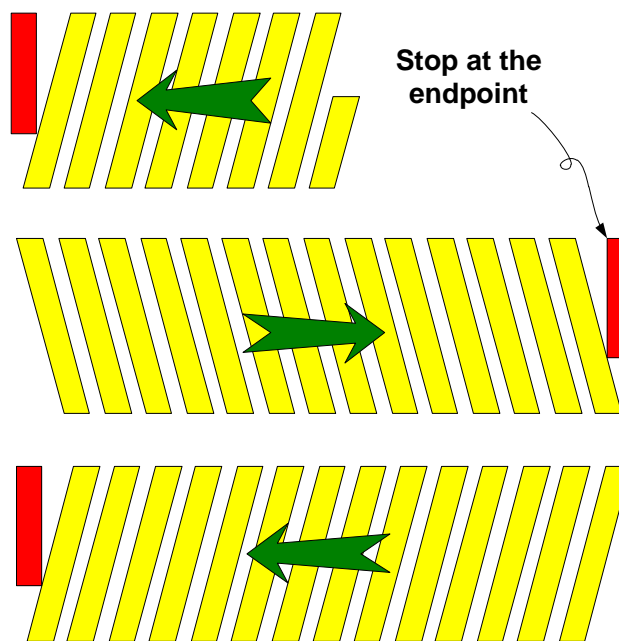

Diagram 3.2 Configuration of tape

The purpose of stopping at the endpoint

Stopping at the end for a set distance divides the bobbin into equal parts as the length the tape stops at the endpoint. It is for staggering the returning positions of tape, so that the tape will not overlap on bobbin and begin to bulge. Furthermore, stopping at the two endpoints for a set length can strengthen the two sides. Diagram 3.3 is the example that

divides the broadside into 8 equal parts by stopping the tape roll for 1/8 of a rotation of the bobbin. Users can plan the best equal parts by different application.

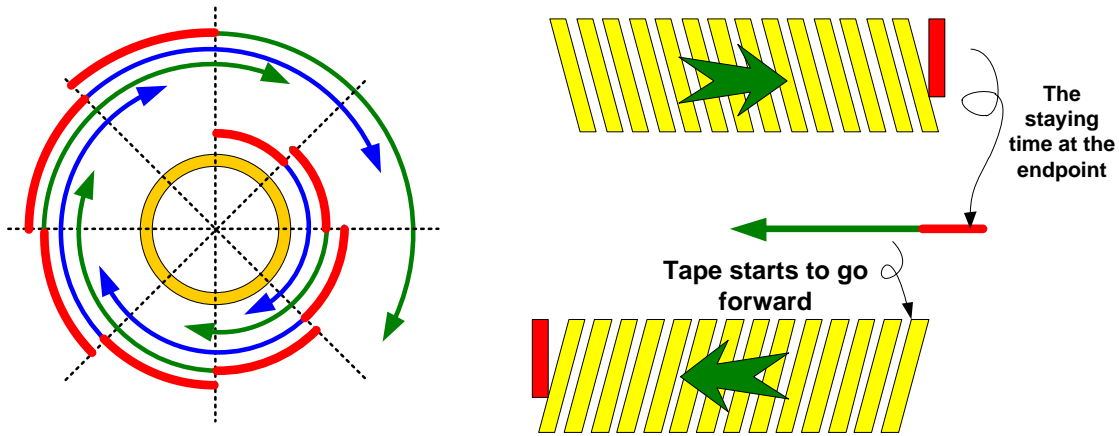

Diagram 3.3 Stop at the endpoint

If the two endpoints are not configured properly or unexpected acceleration / deceleration occurs near the endpoint, it will cause an overlap and bulge at the two sides as per the diagram below. The left figure shows the bulging, the right is the correct example.

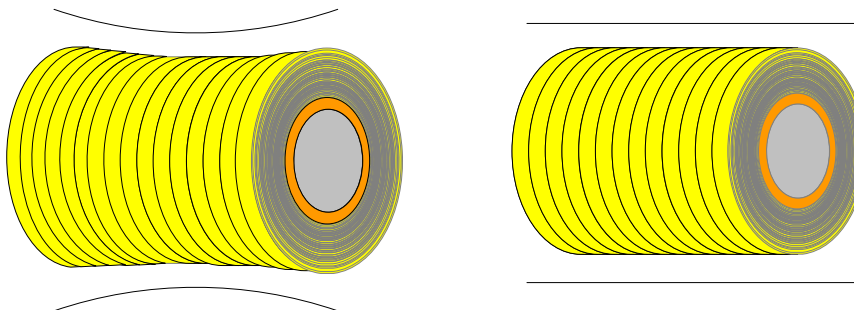

Diagram 3.4 Incorrect and correct wrapping

3.2 E-cam curve design

The horizontal axis of the E-cam curve graph below represents the pulse number which is sent out by the master axis. The vertical axis is the moving distance of the ball screw, which is the wrapping length on the bobbin. The tape shall be placed in orderly arrangement on the bobbin, resulting in a linear E-cam curve.

APPLICATION NOTE



Industrial Automation Business Group

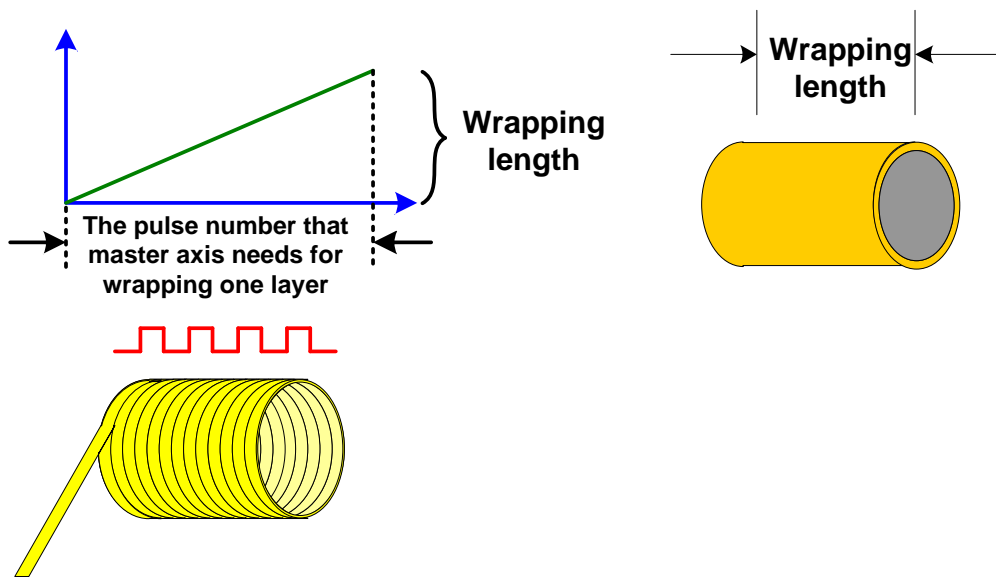

Diagram 3.5 The Design of E-cam curve

Use multiple E-cam curves

In this application, the system applies multiple groups of E-cam curve. The tape starts from the middle of bobbin, when it reaches the endpoint, it stops at the preserved length (The setting of preserved length is not included in E-cam curve. It is completed by lead pulse resulting in no lost pulses due to switching E-cam profiles). After lead pulse completion, we execute another curve of opposite direction to return to the other endpoint. Execute the command repeatedly until it reached the setting value. The configuration of curve and motion is shown as diagram 3.6 and the time sequence of motion is shown as diagram 3.7. It is important to note that disengaging and engaging the ECAM is performed with no lost master pulses, as the disengage and engage of the E-cam occurs on the fly with lead pulses making up the stop at the endpoints.

APPLICATION NOTE



Industrial Automation Business Group

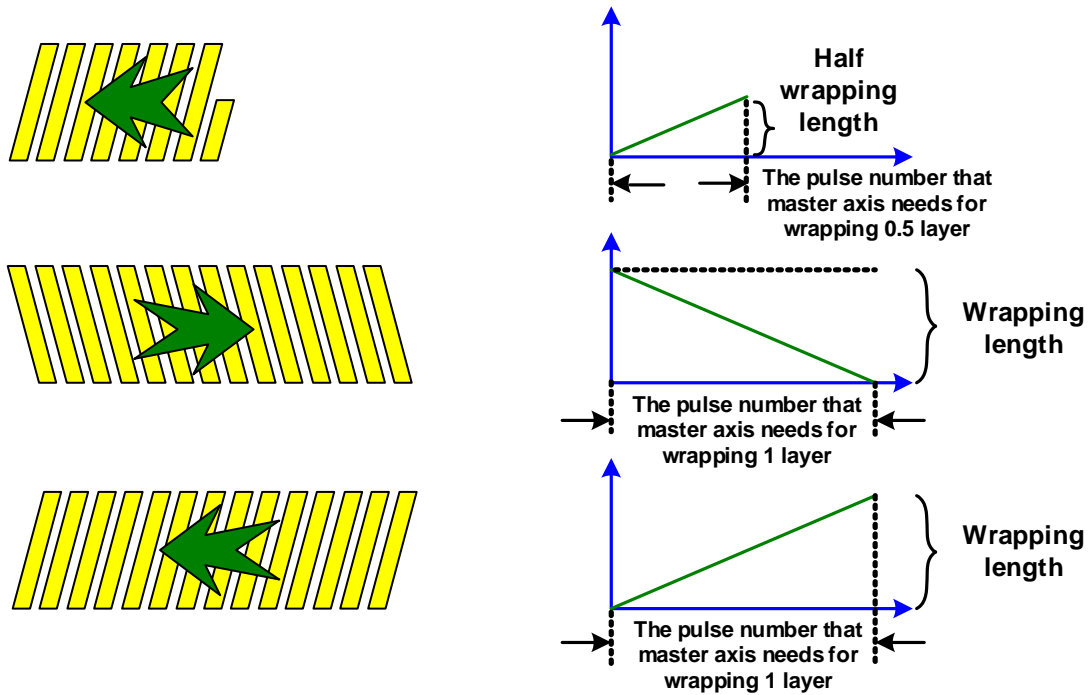

Diagram 3.6 Multiple groups of E-cam curve

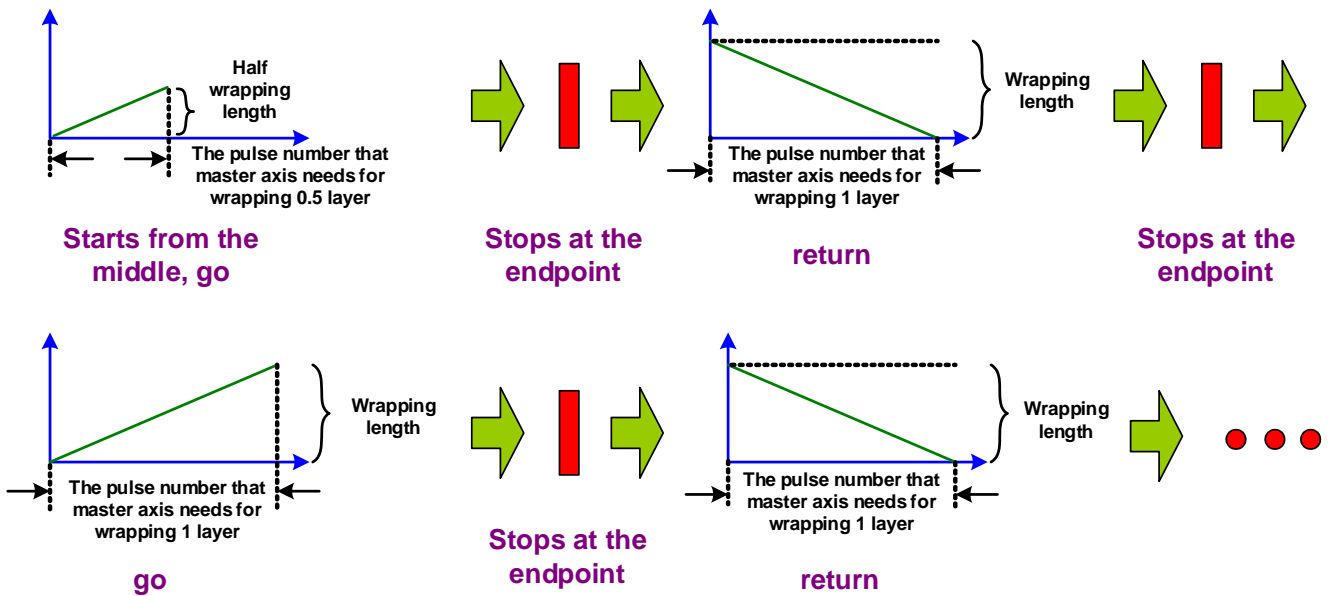

Diagram 3.7 Time sequence of motion

3.3 Example

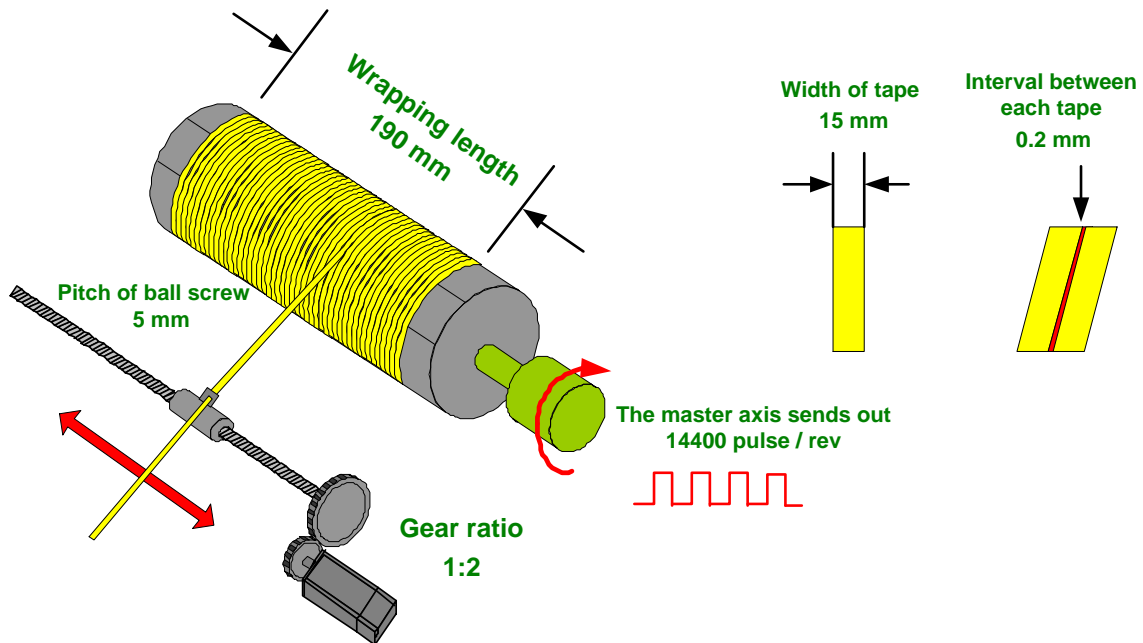

Diagram 3.8 Application example

The master axis sends out 14400 pulses per revolution; the wrapping length is 190mm; the width of tape is 15mm; the interval between each tape is 0.2mm; the pitch of ball screw is 5mm; gear ratio of motor cam shaft and ball screw is 1:2.

The following is the calculation:

$$\text{Total Master Cycles} = 190\text{mm} / (15 + 0.2)\text{mm} = 12.5 \text{ cycle.}$$

This is the amount of tape which can be placed on the bobbin in terms of rotary cycles. However, since its first cycle is the position where the tape stops, when it is applied to slave axis, we must subtract one cycle. See the diagram below.

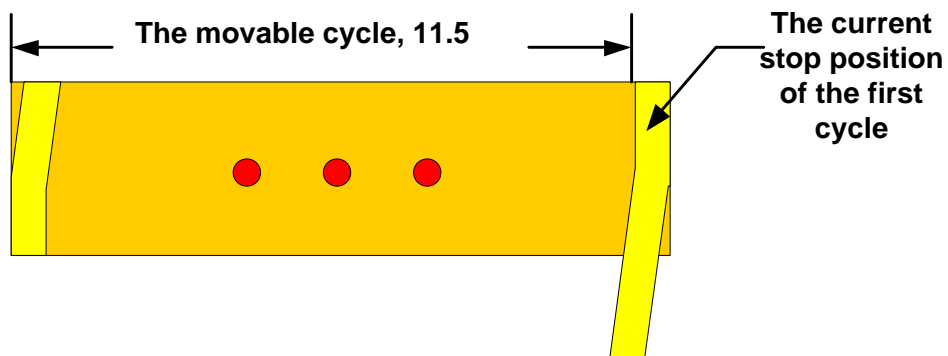

Diagram 3.9 Configuration of tape

$$\text{Total Master Pulses} = (12.5 - 1) * 14400 = 165600 \text{ (pulses)}$$

This is the pulse number that master axis needs for wrapping one layer, which is the pulse number for 11.5 cycles. This value is in ideal situation and not considering any error. The value should be adjusted in real situation. Normally, the actual value is smaller than the estimated one. This is because when estimating the length, the tape is in 90-degrees vertical to bobbin while in real situation the tape is inclined to bobbin.

If it desires to stop at one eighth cycle at two endpoints, then the pulse number it needs will be $14400/8=1800$ pulses, see diagram 3.3.

The configuration of E-cam curve is shown in diagram 3.10.

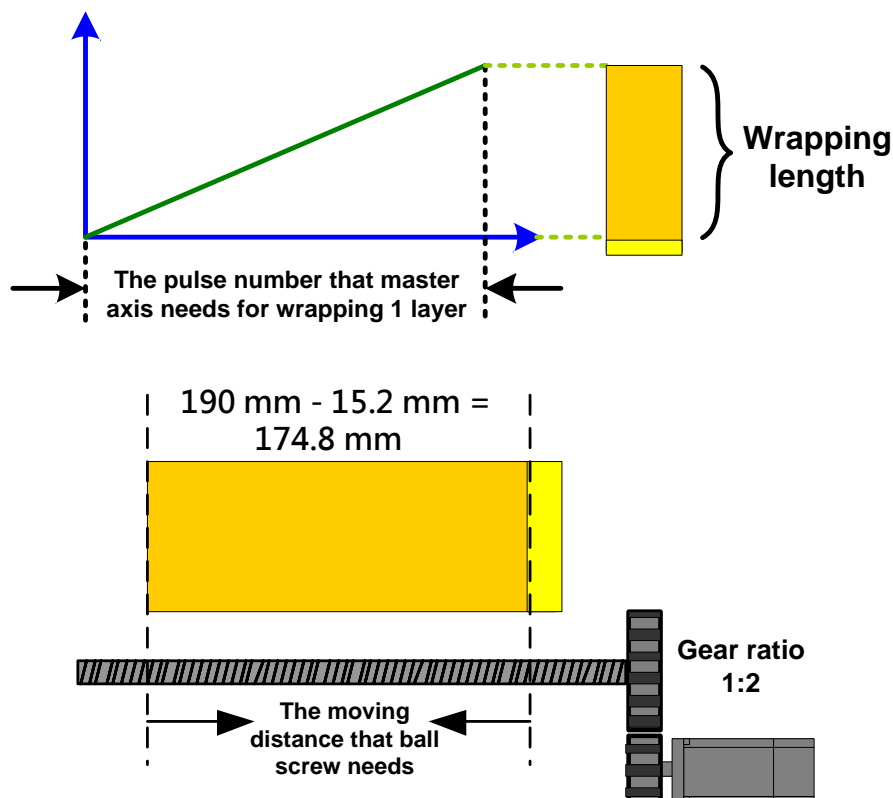

Diagram 3.10 Configuration of E-cam curve

The pitch of ball screw is 5mm. As for the wrapping length, followings are the calculation method:

$$\text{Revolutions of slave axis} = (190 \text{ mm} - 15.2 \text{ mm}) / 5 \text{ (mm/rev)} = 34.96 \text{ rev.}$$

This is the value of the cam on ball screw. When the value corresponds to the motor, according to the calculation of gear ratio, the value should multiply double, which is $34.96 \times 2 = 69.92$ rev.

The PUU for one cycle of gear ratio is 100000PUU (P1-44=128, P1-45=10), thus the PUU of the cam needs to operate is $69.92 \text{ rev} \times 100000 \text{ PUU/rev} = 6992000 \text{ PUU}$. This value is the ideal value which needs to be slightly adjusted when in real situation.

The corresponding relation of E-cam curve is shown as diagram 3.11.

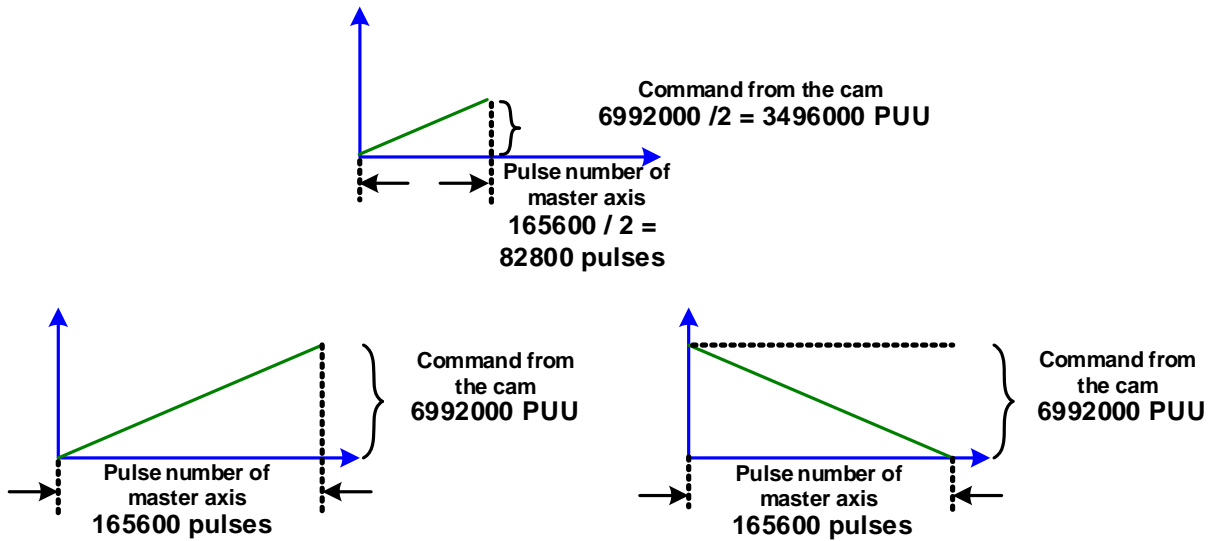

Diagram 3.11 E-cam curve

3.3.1 PR programming and execution

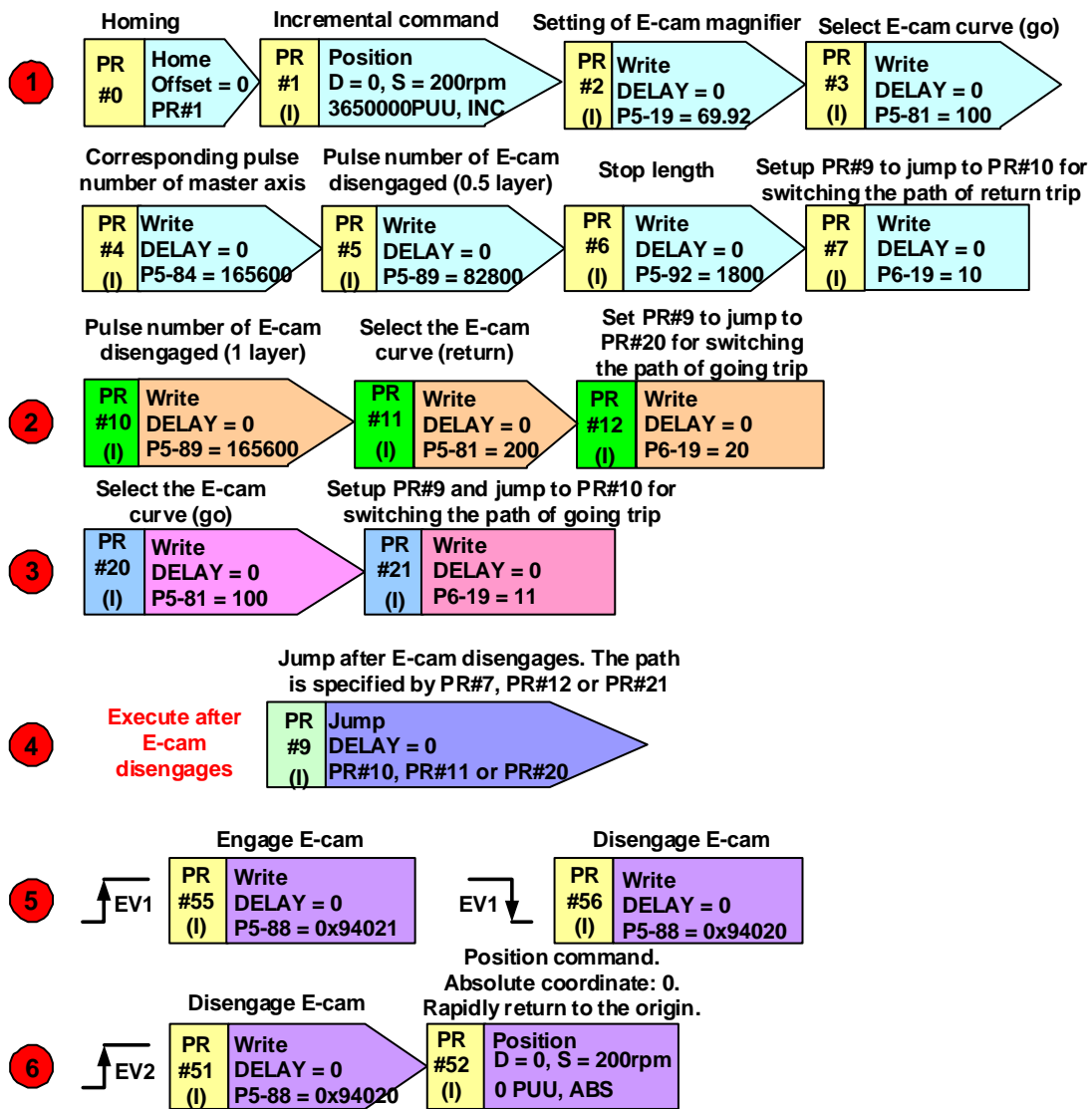

Diagram 3.12 PR blueprint

APPLICATION NOTE



Process #1 Table (Initial Homing and Setup)

PR #	Command	Description
0	Homing	Home with 0 offset before system operation, execute PR1 afterwards
1	Incremental Command	<p>After homing, perform an incremental move to the center of the bobbin. This position should be adjusted according to the length of the bobbin.</p> <p style="text-align: center;"><i>Diagram 3.13 Original point and the middle point</i></p>
2	Set E-cam curve magnification	<p>Set P5-19=69.92 to set E-cam magnification. Different length of bobbins would require different magnification values</p> <p style="text-align: center;"><i>Diagram 3.14 E-cam curve magnification</i></p>
3	Select starting E-cam curve	Set P5-81=100 to select the 'go' E-cam curve. There should be two E-cam curves in total in the data array.

APPLICATION NOTE

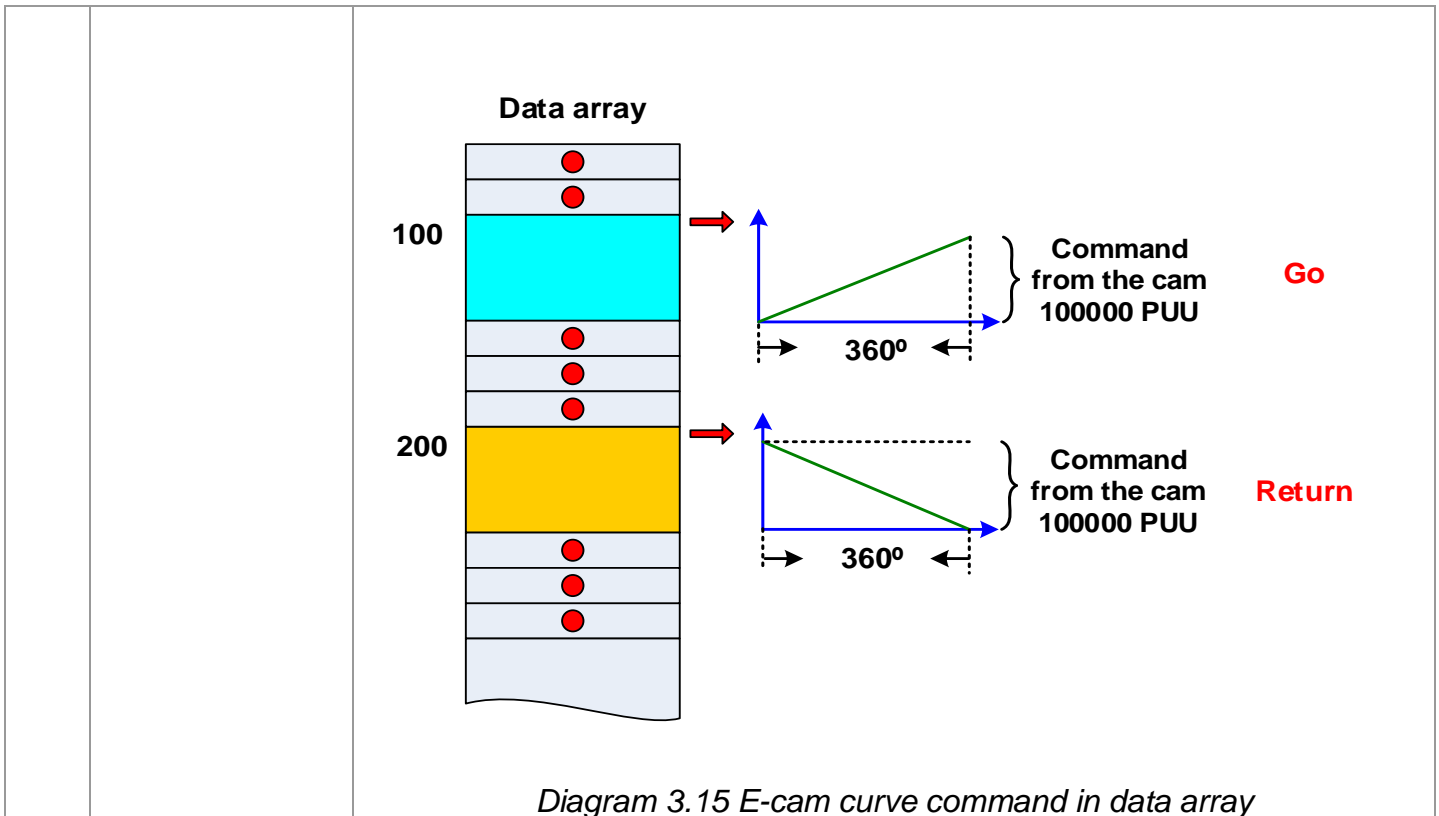

Diagram 3.15 E-cam curve command in data array

4	Set the master axis pulse number	Set P5-84=82800 for the pulses of wrapping for the length of the bobbin. See diagram 3.11
5	Set the disengage length of the E-cam	The disengaged length of the first E-cam is P5-89 = 82800 due to being half length. See diagram 3.11
6	Stop length	Set P5-92=1800 to set the stop length at the ends using the E-cam lead pulse. See diagram 3.3
7	Setup PR#9 for return to proper location	Write P6-19=10. Our E-cam is configured to call PR#9 upon disengaging. This is to setup the target that PR#9 jumps to after completing the first run so the 'return' E-cam can be set.

Process #2 Table (Jump from PR#9 on 'go' E-cam disengaged)

PR#	Command	Description
10	Set the disengage length of the E-cam after first run	Set P5-89=165600 to set the pulse number that the slave axis receives from the master before disengaging to 1 layer. This PR is only called after the first run.
11	Select the e-cam curve (return)	Set P5-81 to 200 to select the 'return' E-cam curve for return trip on the bobbin. See diagram 3.15

APPLICATION NOTE



12	Setup PR#9 for return to proper location	Write P6-19=20 so that upon disengaging the E-cam, PR#9 jumps to select the right E-cam curve.
-----------	--	--

Process #3 Table (Jump from PR#9 on 'return' E-cam disengaged)

PR#	Command	Description
20	Select the e-cam curve (go)	Set P5-81 to 100 to select the 'go' E-cam curve for the forward trip on the bobbin. See diagram 3.15
21	Setup PR#9 for return to proper location	Write P6-19=11 so that upon disengaging the E-cam, PR#9 jumps to select the right E-cam curve.

Process #4 Table (E-cam disengaged)

PR#	Command	Description
9	Jump Command	When E-cam reaches end of cycle, it will disengage and execute this PR. The target of this PR is changed to ensure the proper E-cam parameters are set for 'go' and 'return' travel.

Process #5 Table (DI to start E-cam)

PR#	Command	Description
55	Enable E-cam parameter	Set P5-88 to 0x94021 upon rising edge of EV1 input. This input enables the E-cam on the slave. 1→Enable E-cam 2→Master axis is pulse command 0→Ecam engages immediately 4→Ecam will disengage at 360 degrees and immediately execute lead pulse set by P5-92. After lead pulse is achieved, E-cam will immediately engage and re-execute ECAM 9→Upon disengaging, execute PR#9
56	Disable E-cam operation	Set P5-88 to 0x94020 upon falling edge of EV1 input to disable E-cam operation

Process #6 Table (DI to stop E-cam, return home)

PR#	Command	Description
51	Disable E-cam operation	Set P5-88 to 0x94020 upon trigger from EV2 input.
52	Absolute move	Move to 0 position, which is original home position.

Diagram showing the main flow chart of PR application

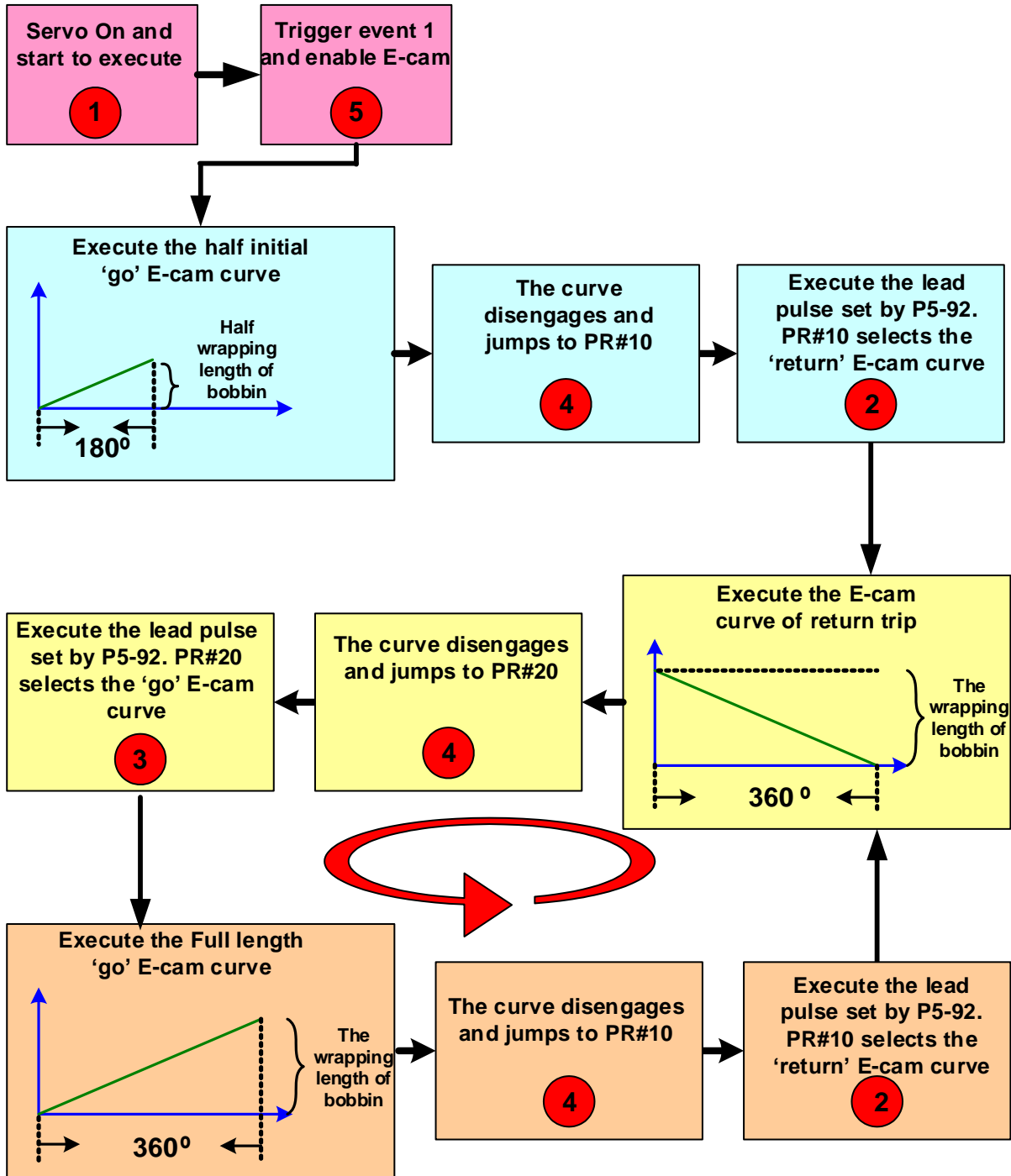

Diagram 3.16 Time sequence of PR execution

3.3.2 System adjustment

The length of bobbin remains and the width of tape is changed.

See diagram 3.17. Assume the tape is changed from 15mm to 10mm and the interval and the length of bobbin remain at 0.2mm and 190mm respectively.

APPLICATION NOTE

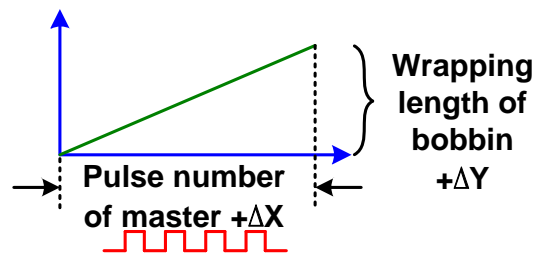
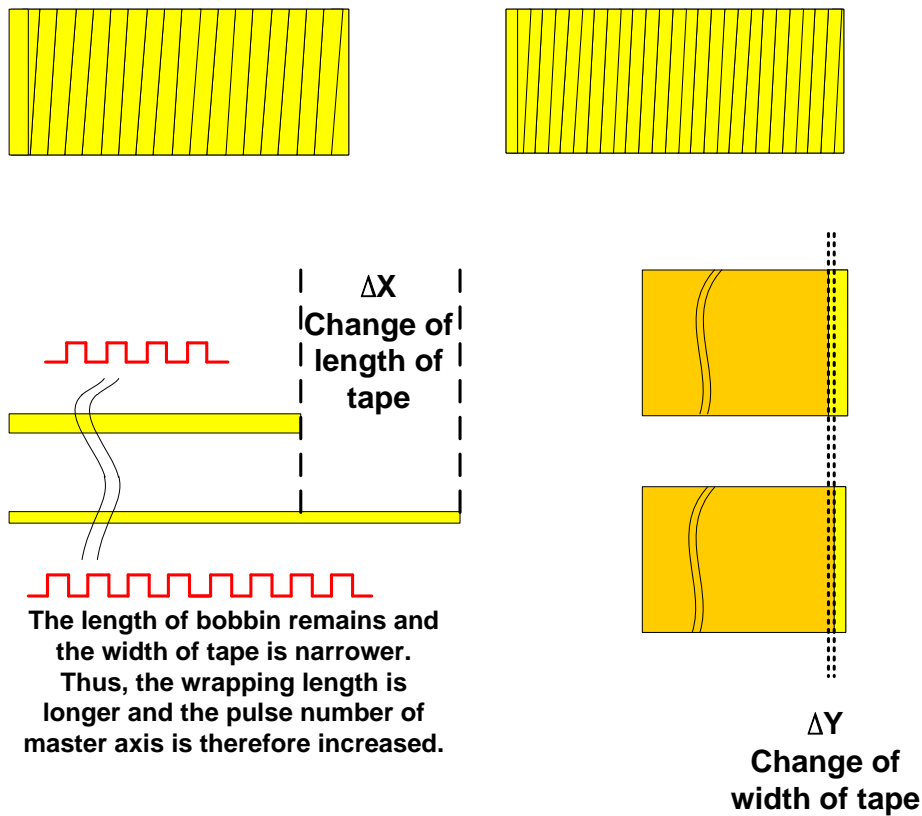

Diagram 3.17 Change of tape width

ΔY , adjust the parameter of E-cam distance:

$$190\text{mm} - 10.2\text{mm} = 179.8 \text{ mm};$$

$$179.8\text{mm} / 5 \text{ (mm/rev)} = 35.96 \text{ rev, the cycle the ball screw travels};$$

$$35.96 * 2 = 71.92 \text{ rev, converse to motor by E-cam};$$

PR#2: P5-19=71.92.

ΔX , adjust the pulse number sent by master axis:

$$190\text{mm} / (10\text{mm} + 0.2\text{mm}) = 18.62745 \text{ cycles};$$

$$(18.62745 - 1)\text{cycle} * 14400 \text{ (pulse/cycle)} = 253835 \text{ pulse};$$

PR#4: P5-84=253835/2=126917;

PR#5: P5-89=126917;

PR#11: P5-84=253835;

PR#12: P5-89=253835.

The length of the bobbin is changed and the width of tape remains.

See diagram 3.18. Assume the length of bobbin is changed from 190mm to 150mm and the width of tape and the interval remain at 15mm and 0.2mm respectively.

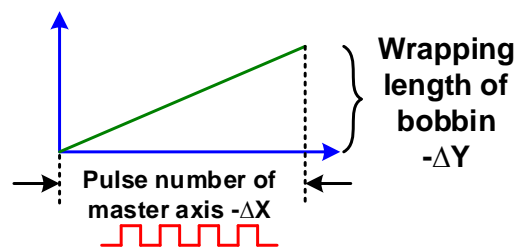
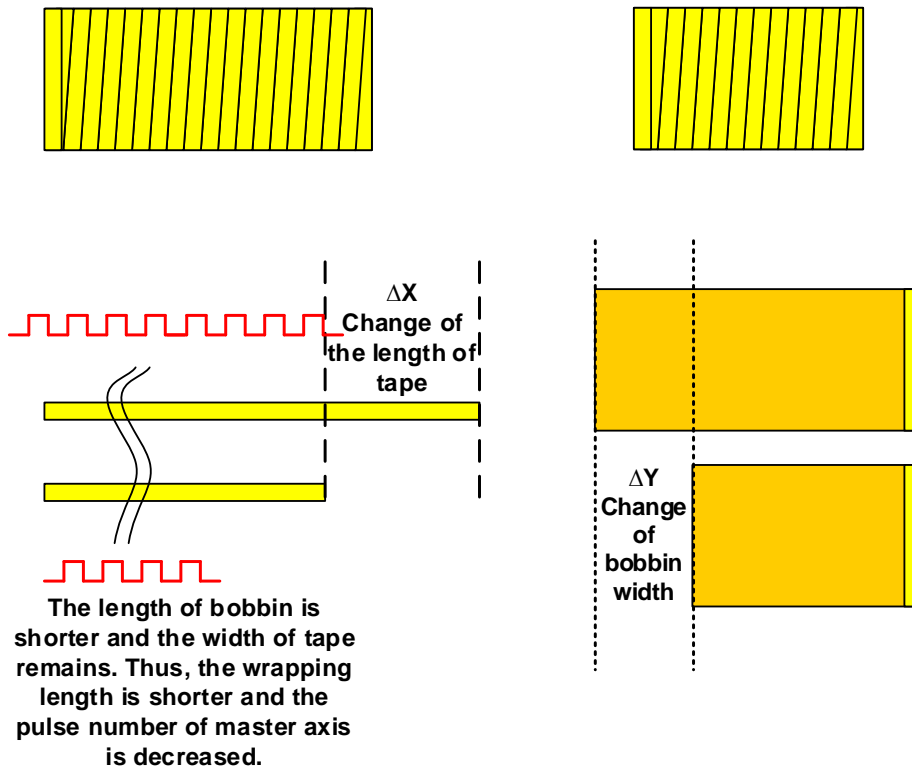

Diagram 3.18 Change of bobbin length

ΔY , adjust the parameter of E-cam distance:

$$150\text{mm} - 15.2\text{mm} = 134.8 \text{ mm};$$

$$134.8\text{mm} / 5 \text{ (mm/rev)} = 26.96 \text{ rev, the cycle the ball screw travels;}$$

$$26.96 * 2 = 53.92 \text{ rev, converse to motor by E-cam;}$$

PR#2: P5-19=53.92.

ΔX , adjust the pulse number sent by master axis:

$$150\text{mm} / (15\text{mm} + 0.2\text{mm}) = 9.8684 \text{ cycles};$$

$$(9.8684 - 1)\text{cycle} * 14400 \text{ (pulse/cycle)} = 127704 \text{ pulse};$$

PR#4: P5-84=127704/2=63852;

PR#5: P5-89=63852;

PR#11: P5-84=127704;

PR#12: P5-89=127704.

Looking for the middle point of bobbin:

PR#1: Incremental command 2850000PUU

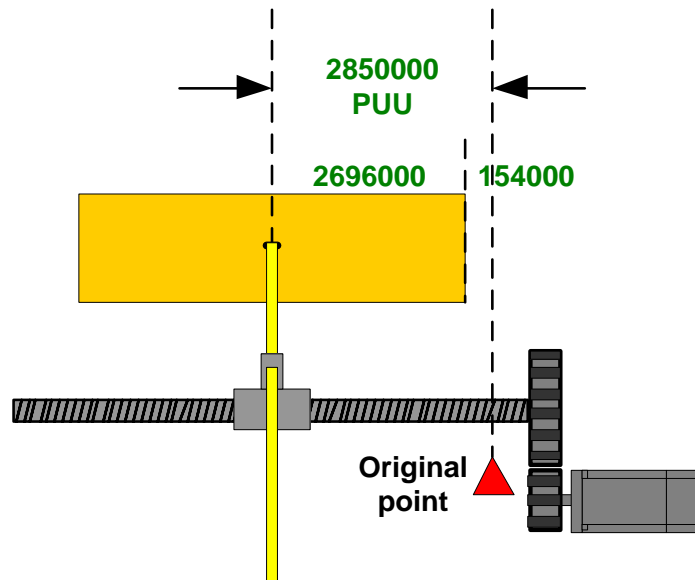

Diagram 3.19 Looking for the middle point of bobbin

4 Building the E-cam curve in ASDASoft

In this application, to build the E-cam curve is quite easy, only by one linear line will do. It is not suitable to plan acceleration/deceleration on two endpoints in this application. Otherwise, it might overlap at the two endpoints because of the deceleration. See diagram 3.4 for the result and Diagram 4.1 for the causes. It proves that during the motor operation, either in forward or backward direction, no additional acceleration and deceleration is applied in the application. Thus, in mechanical design, low inertia and rigid mechanism should be the first priority. If the gear box is directly applied on camshaft, the effect will be better than belt.

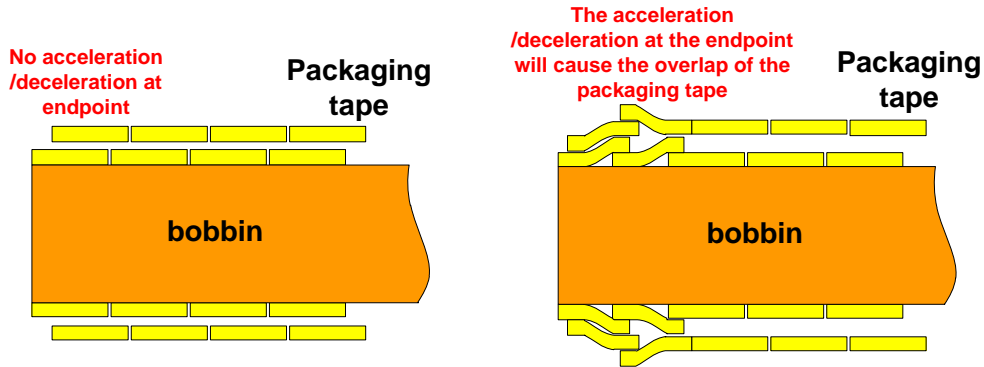

Diagram 4.1 Tape overlap caused by acceleration/deceleration curve

Only one linear line is needed to build in E-cam curve which is shown in the following diagram. Note that the 'going' E-cam curve is used for both the half length travel and the full length travel on the bobbin. For the half length travel, the only difference is the disengage pulse number is 1/2 the full length travel.

P5-81 : Start position of Data Array

P5-82: E-CAM Area Number: N(4~719)

	0	1	2	3	4	5
θ[°]	0	72	144	216	288	360
Position Y	0	20000	40000	60000	80000	100000

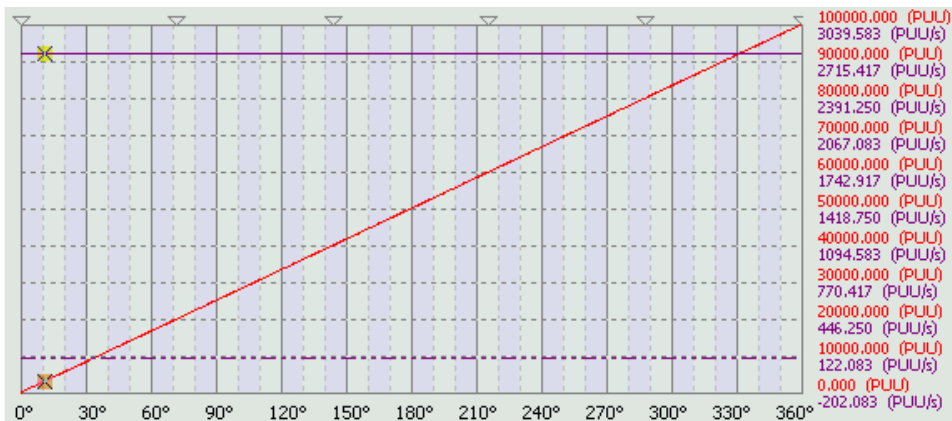

Diagram 4.2 E-cam curve of the whole going trip for example

APPLICATION NOTE



Industrial Automation Business Group

P5-81: Start position of Data Array
 P5-82: E-CAM Area Number: N(4~719)

	0	1	2	3	4	5
θ [°]	0	72	144	216	288	360
Position Y	100000	80000	60000	40000	20000	0

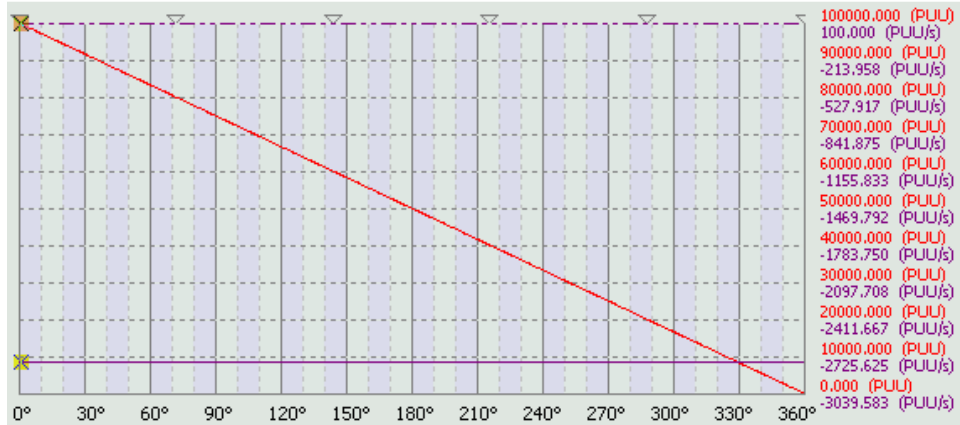

Diagram 4.3 E-cam curve of the whole return trip for example

Delta Products Corporation

Industrial Automation Business Group

5101 Davis Drive, RTP NC 27709

T: 919 767 3913

